



 **KINGSEAL**
COMPANY LIMITED THAILAND
QUALITY SEALS FOR ALL APPLICATIONS



Generic Seal Kits Catalog

46/152-153 Moo 3 Sri Saman Road
Baan Mai Pakkret, Nonthaburi Thailand 11120

Tel: +662 9617534 to 6

Fax: +662 9617540

Email: intlsales@kingseal.co.th / kingsealmail@gmail.com

Website: <http://www.kingseal.co.th>

SECTION		PAGE	INDUSTRIAL KITS	MOBILE KITS	ASSORTMENT SEAL KITS & TOOLS	APPENDIX				
Introduction										
ii-iii	Product Index by Industry									
iv	Seal Kit Identification Code Conversion Chart	ii - iv								
Industrial Kits										
1	Index - Industrial Kits									
2	Material Used / Glossary of Terms									
3	Industrial Kits	1 - 76								
Mobile Kits										
77	Index - Mobile Kits									
78 - 503	Mobile Kits	77 - 503								
Assortment Kits and Tools										
505	Index - Assortment Kits and Tools									
506 - 522	Assortment Kits									
523 - 529	Tools	505 - 529								
Appendix										
531 - 543	Technical Information	531 - 543								



PRODUCT INDEX BY INDUSTRY

Repair Kits and Parts

CONSTRUCTION EQUIPMENT	PAGE #	LOGGING EQUIPMENT	PAGE #
Bobcat	83 - 89	Barko	81
Caterpillar	91 - 206	Bell.....	82
Champion Motor Graders	206	Caterpillar	91 - 206
Clark-Michigan (Volvo)	481 - 499	Clark-Michigan (Volvo)	481 - 499
Driltech	218	Eaton-Yale, Timberjack	219
Dynahoe	218	ESCO	219
Euclid Trucks.....	219	Franklin	236 - 237
Fiat-Allis.....	220	Husky Brute	273
Ford	221 - 236	Hydro-Ax.....	286
Furukawa.....	237	J.I. Case.....	301 - 342
Galion - Dresser	237	John Deere	343 - 394
Grove Crane	243 - 246	Log Hog	438
Hitachi.....	256 - 273	Morbark	445
Hyundai	287	Peerless.....	454
Ingersoll-Rand	288	Prentice	458 - 466
International Harvester	288	Ronen	467
JCB.....	289 - 298	Rotobec.....	467
J.I. Case.....	301 - 342	Tigercat.....	473
John Deere	343 - 394	Timber Jack	474 - 477
Kato	395	Young Grapple	501
Kobelco.....	396 - 404		
Koehring	404	FORK LIFTS	PAGE #
Komatsu	405 - 434	Allis-Chalmers	78
Kubota	435 - 436	Baker	79 - 80
Liebherr	437	Cascade	90
Link Belt.....	437	Champion	206
Massey Ferguson	441	Clark	208 - 209
Mitsubishi.....	442 - 445	Crown	212
Monarch Road Machinery	445	Gehl.....	238 - 239
Pettibone	456 - 457	Gradall.....	240 - 242
Reynolds Scraper	467	Hyster	286 - 287
Samsung	468	Kalmar	394
Takeuchi	469 - 470	Komatsu	429
TCM.....	471	Lull	439
Terex.....	472 - 473	Mitsubishi.....	442 - 445
Trojan Loader.....	479	Nissan.....	447
Volvo.....	481 - 499	Pettibone	456 - 457
Wabco	499	Raymond	467
Whiteman/Conspray	501	TCM.....	471
Yanmar	501	Towmotor-Caterpillar	206
Yutani.....	502 - 503	Toyota	477 - 479
		White	500
		Yale.....	501

PRODUCT INDEX BY INDUSTRY

Repair Kits and Parts

CRANES, LOADERS & PERSONNEL LIFTS

	PAGE #
Barko	81
Effer Cranes	219
Fassi-Crane	220
FMC	220
Grove Crane	243 - 246
Hiab	253 - 255
Hyundai	287
JLG Industries	299
Lorain	439
Lucky Loader	439
Mark Hi-Lift	441
New Holland	446
P & H Cranes	457
Prentice	458 - 466
Snorkel	468
Steelmaster	468

DUMP BODIES

	PAGE #
Fruehauf	237

REFUSE EQUIPMENT

	PAGE #
Dempster	218
Garwood	237
Heil	247 - 252
Leach	437
Loadmaster	438
Pak-Mor	449 - 450
Peabody-Galion	451 - 453

LIFT GATES PAGE

Venco	479
Waltco	499

INDUSTRIAL CYLINDERS

	PAGE #
Atlas	3 - 10
Hydroline	11 - 32
Miller	33 - 48
Ortman	448
Parker	49 - 68
Royal	69 - 72
Sheffer	73 - 76
Tompkins Johnson	477

TELESCOPIC CYLINDERS

	PAGE #
Anthony	78 - 79
Atlas	79
Commercial	210 - 211
Custom Hoists	213 - 217
Fontaine	220
Glencoe	239
Heil	247 - 252
Hycos	274 - 286
Johnson	394
Mailhot	439
Marion	440
Peabody-Galion	451 - 453
Perfection-Cobey	454 - 455
Ward	500

MISCELLANEOUS

	PAGE #
Cameco	90
Chief Cylinders	207
Cross	212
Densmore	218
Edbro Cylinders	219
Energy	219
Harsh Mfg.	246
Meyer Products	442
Pandrol Jackson	448
Prince	466
Red Lion Tie Rod Cylinders	467
Tamrock	468

PUMP & MOTOR PARTS

	PAGE #
Anthony	79
Charlynn Seal Kits	207
Peabody-Galion	453
Perfection-Cobey	455



SEAL KIT IDENTIFICATION CODE CONVERSION CHART

WIPERS

I = Insert
P = Press In
N = No Wiper

ROD SEALS

O = O-Ring
OB = O-Ring & B/U
U = U-Seal
UB = U-Seal & Buffer
V = Vee Set
N = None
TR = T Seal
SP = Special
UV = U-Seals &
Vee Sets

PISTON SEALS

1 = None
2 = O-Ring
3 = O-Ring & B/U
4 = 1 U-Seal
5 = 2 U-Seals
6 = 1 Piston Cup
7 = 2 Piston Cups
8 = "SA" Vee Set
9 = "DA" Vee Set
10 = Piston Seal
11 = T Seal
12 = Cast Iron Piston Ring
13 = Special
14 = 4 Piece Capped T-Seal
15 = 5 Piece Piston Seal

ROD X BORE SIZE

EXAMPLE

P - U - 5 2 X 4
Wiper Rod Piston Rod Bore
Seal Seal

NOTE:

These codes were developed as an aid for kit identification. Verification can be made by calling our sales department and comparing the parts to be replaced with those offered in our kit.

Industrial Kits

CONTENTS	PAGE
Materials Used / Glossary of Terms	2
Atlas Cylinder Repair Kits	3 - 10
Hydro-Line Cylinder Repair Kits	11 - 31
Miller Cylinder Repair Kits	33 - 47
Parker Cylinder Repair Kits	49 - 67
Royal Cylinder Repair Kits	69 - 72
Sheffer Cylinder Repair Kits	73 - 75



KINGSEAL CO., LTD. THAILAND

46/152-153 Moo 3 Sri Saman Road
Baan Mai Pakkret, Nonthaburi Thailand 11120

Tel: +662 9617534 to 6

Fax: +662 9617540

Email: intlsales@kingseal.co.th / kingsealmail@gmail.com

Website: <http://www.kingseal.co.th>

Materials Used

Urethane (URE)

Formulated of copolymers of ether or ester based urethanes, this material is used in a wide application of seals, wipers, back-up rings, cushions, bumpers, and a myriad of other uses. Highly resistant to oil swell, ozone, oxidation and abrasion, it also has excellent cut resistance. Highly resilient, urethanes also have high tensile strength and elongation properties. Urethanes remain an excellent choice in hydraulic systems using petroleum based fluids. Most urethane seals remain flexible and efficient in temperatures ranging from -65° F to +200° F with some able to withstand intermittent temperatures up to +300° F.

Nitrile (NBR) (XNBR)

Two common nitrile copolymer blends are Buna-N (NBR) and Carboxylated Nitrile (XNBR). Possessing very good resistance to petroleum based hydraulic oils, Buna-N also works well with fuels such as diesel or gasoline. XNBR compounds feature improved abrasion resistance and tensile strength. Nitrile seals have a good resistance to compression set, but their flexibility suffers somewhat in the lower temperature range. Seals made from this material have a low resistance to ozone and must be stored carefully in most environments. Working temperatures are -40° to +240°F.

Polytetrafluoroethylene (PTFE)

Most PTFE seals, in order to retain their toughness and flexibility, are fortified with short glass fiber, bronze flashes, carbon, graphite, or a combination of these fillers. Because of a lack of resilience (memory) in PTFE, an energizer is most often employed to obtain the desired fit. Benefits are chemical inertness, high heat resistance, low temperature flexibility, low running friction, and non-adhesive characteristics. Temperatures to +500° F are obtainable but are often reduced by the filler or energizer employed.

Fluorocarbon (FC)

Fluorocarbon combines high temperature resistance with excellent chemical resistance. Excellent for use with alcohol and aromatic fuels and is highly resistant to ultraviolet light and ozone. This material is not recommended for use in low temperatures or in aircraft hydraulic fluids. Temperature range is -20° to +400° F.

Glossary of Terms

Bearing/Wear Rings

Soft metal or plastic rings placed in grooves on the piston or in the head to prevent contact between hard metal surfaces.

Durometer

A generic term referring to the instrument and the scale used to measure the relative hardness of various elastomers. The lower the durometer rating, the softer the material.

Dynamic Seal

A sealing device used between mating surfaces that have relative motion.

Elastomer

A rubber-like material having the capacity for large deformation and rapid, complete recovery from the deforming force.

Gland

A rod bushing containing sealing devices fitted into the rod end cap. A groove or open area machined into the head or piston that houses the sealing device.

Static Seal

A sealing device used between mating surfaces that have no relative motion.

Wiper/Scraper

A device placed in the head of a cylinder for the purpose of excluding foreign matter from the inside of the cylinder.

ATLAS

Kit Type		Page
Series A & L	Rod Gland Kits	4
	Rod Seal Kits	5
	Piston Kits	6
	Head Seal Kits	7
Series H	Piston Seal Kits	8
	Head Seal Kits	9
Rod Kits	Hydraulic Cylinders	10
Piston Kits	Hydraulic & Pneumatic Cylinders	11



KINGSEAL CO., LTD. THAILAND

46/152-153 Moo 3 Sri Saman Road
Baan Mai Pakkret, Nonthaburi Thailand 11120

Tel: +662 9617534 to 6

Fax: +662 9617540

Email: intlsales@kingseal.co.th / kingsealmail@gmail.com

Website: <http://www.kingseal.co.th>

ATLAS

Series A & L Rod Gland Kits

Series A & L Cylinders Nitrile

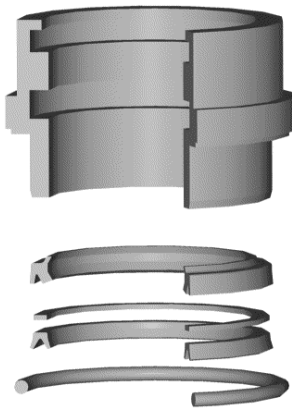

Kit Includes:

- 1 Bronze Gland
- 1 XNBR Wiper
- 1 PTFE Back-Up Ring
- 1 NBR U-Seal
- 1 NBR O-Ring

Series L Cylinders Urethane

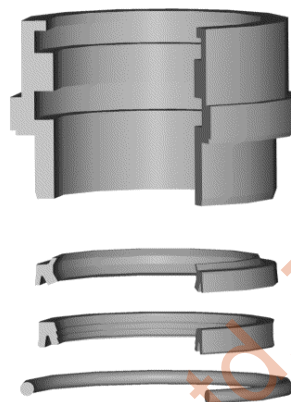

Kit Includes:

- 1 Bronze Gland
- 1 XNBR Wiper
- 1 Multi-lip Urethane U-Seal
- 1 NBR O-Ring

Series A & L Cylinders Fluorocarbon

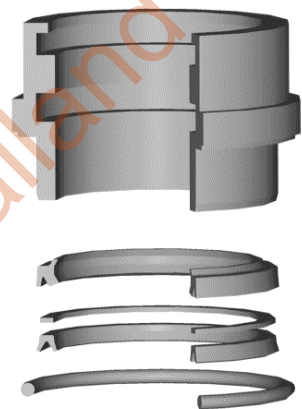

Kit Includes:

- 1 Bronze Gland
- 1 FC Wiper
- 1 PTFE Back-Up Ring
- 1 FC U-Seal
- 1 FC O-Ring

Bore Dia.	(NBR) Kit #	List Price	(URE) Kit #	List Price	(FC) Kit #	List Price
5/8"	ATL-4A06R000S	\$ 52.94	ATL-EA06R000S	\$ 55.15	ATL-4A06R000V	\$ 70.30
1"	ATL-4A10R000S	62.30	ATL-EA10R000S	61.67	ATL-4A10R000V	82.61
1-3/8"	ATL-4A13R000S	74.62	ATL-EA13R000S	70.88	ATL-4A13R000V	85.26
1-3/4"	ATL-4A17R000S	87.98	ATL-EA17R000S	83.70	ATL-4A17R000V	101.40
2"	ATL-4A20R000S	103.21	ATL-EA20R000S	102.70	ATL-4A20R000V	118.68
2-1/2"	ATL-4A25R000S	117.40	ATL-EA25R000S	115.42	ATL-4A25R000V	141.23
3"	ATL-4A30R000S	145.00	ATL-EA30R000S	153.70	ATL-4A30R000V	170.99

ATLAS

Series A & L Rod Seal Kits

Series A Cylinders Nitrile

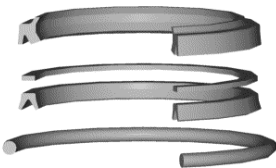

Kit Includes:

- 1 XNBR Wiper
- 1 PTFE Back-up Ring
- 1 NBR U-Seal
- 1 NBR O-Ring

Series L Cylinders Urethane

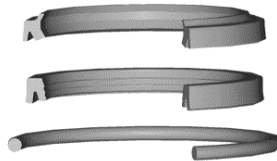

Kit Includes:

- 1 XNBR Wiper
- 1 Multi-lip Urethane U-Seal
- 1 NBR O-Ring

Series A & L Cylinders Fluorocarbon

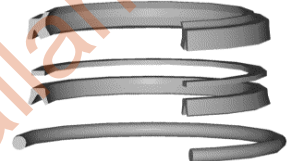

Kit Includes:

- 1 FC Wiper
- 1 PTFE Back-up Ring
- 1 FC U-Seal
- 1 FC O-Ring

Bore Dia.	(NBR) Kit #	List Price	(URE) Kit #	List Price	(FC) Kit #	List Price
5/8"	ATL-4A06S000S	\$ 6.64	ATL-EA06S000S	\$ 5.59	ATL-4A06S000V	\$ 18.44
3/4"	ATL-4A07S000S	8.95	ATL-4A07S000S	8.95	ATL-4A07S000V	26.45
1"	ATL-4A10S000S	6.65	ATL-EA10S000S	6.02	ATL-4A10S000V	19.01
1-3/8"	ATL-4A13S000S	6.81	ATL-EA13S000S	6.43	ATL-4A13S000V	20.00
1-3/4"	ATL-4A17S000S	8.58	ATL-EA17S000S	7.52	ATL-4A17S000V	22.41
2"	ATL-4A20S000S	9.59	ATL-EA20S000S	9.68	ATL-4A20S000V	23.34
2-1/2"	ATL-4A25S000S	13.05	ATL-EA25S000S	11.08	ATL-4A25S000V	29.51
3"	ATL-4A30S000S	18.64	ATL-EA30S000S	22.44	ATL-4A30S000V	34.64
3-1/2"	ATL-4A35S000S	20.39	ATL-EA35S000S	32.49	ATL-4A35S000V	43.08
4"	ATL-4A40S000S	21.89	ATL-EA40S000S	36.20	ATL-4A40S000V	65.93
4-1/2"	ATL-4A45S000S	26.73	ATL-EA45S000S	40.26	ATL-4A45S000V	74.35
5"	ATL-4A50S000S	31.16	ATL-EA50S000S	43.67	ATL-4A50S000V	100.00

ATLAS

Series A & L Piston Kits

Series A Cylinders Nitrile

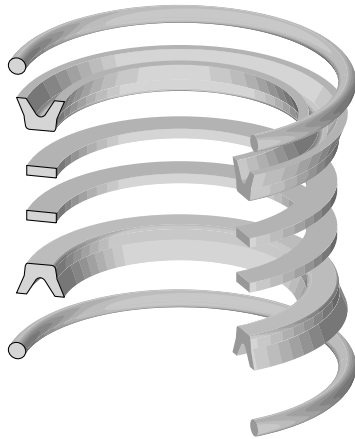

Kit Includes:

2 NBR U-Seals
2 HP URE Back-Up Rings
2 NBR O-Ring Head Seals

Series L Cylinders Nitrile

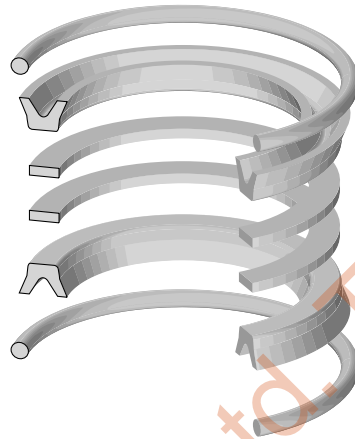

Kit Includes:

2 NBR U-Seals
2 HP URE Back-Up Rings
2 NBR O-Ring Head Seals

Series A & L Cylinders Fluorocarbon

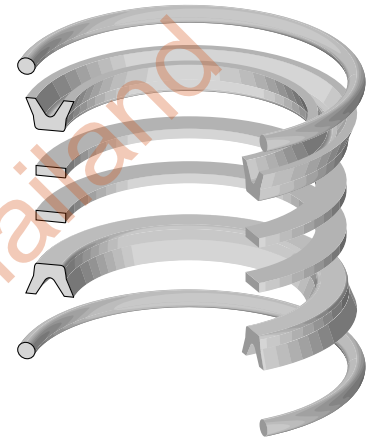

Kit Includes:

2 FC U-Seals
2 HP URE Back-Up Rings
2 FC O-Ring head Seals

Bore Dia.	(NBR) Kit #	List Price	(NBR) Kit #	List Price	(FC) Kit #	List Price
1-1/2"	ATL-4B00S015S	\$ 5.35	ATL-EB00S015S	\$ 5.35	ATL-4B00S015V	\$ 24.56
2"	ATL-4B00S020S	6.38	ATL-EB00S020S	6.38	ATL-4B00S020V	28.08
2-1/2"	ATL-4B00S025S	7.30	ATL-EB00S025S	7.30	ATL-4B00S025V	38.92
3-1/4"	ATL-4B00S032S	8.86	ATL-EB00S032S	8.86	ATL-4B00S032V	41.79
4"	ATL-4B00S040S	11.30	ATL-EB00S040S	11.30	ATL-4B00S040V	49.55
5"	ATL-4B00S050S	13.67	ATL-EB00S050S	13.67	ATL-4B00S050V	61.45
6"	ATL-4B00S060S	17.76	ATL-EB00S060S	17.76	ATL-4B00S060V	84.51
7"	ATL-4B00S070S	49.52	ATL-4B00S070S	49.52	ATL-4B00S070V	152.81
8"	ATL-4B00S080S	56.18	ATL-EB00S080S	56.18	ATL-4B00S080V	184.23
10"	ATL-4B00S100S	79.98	ATL-4B00S100S	79.98	ATL-4B00S100V	255.32
12"	ATL-4B00S120S	108.23	ATL-4B00S120S	108.23	ATL-4B00S120V	396.29
14"	ATL-4B00S140S	167.57	ATL-4B00S140S	167.57	ATL-4B00S140V	584.18

HP URE - High Performance Urethane

ATLAS

Series A & L Head Seal Kits

Series A & L Head Seal Kits

Nitrile

Fluorocarbon

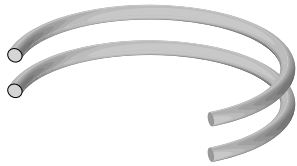

Kit Includes:
2 NBR O-Ring Head Seals

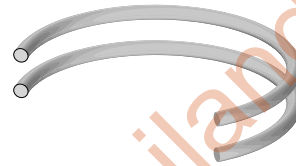

Kit Includes:
2 FC O-Ring Head Seals

Bore Dia.	(NBR) Kit #	List Price	(FC) Kit #	List Price
1-1/2"	ATL-4E00S015S	\$ 3.10	ATL-4E00S015V	\$ 4.46
2"	ATL-4E00S020S	3.29	ATL-4E00S020V	7.57
2-1/2"	ATL-4E00S025S	3.68	ATL-4E00S025V	9.93
3-1/4"	ATL-4E00S032S	3.72	ATL-4E00S032V	11.59
4"	ATL-4E00S040S	3.92	ATL-4E00S040V	14.93
5"	ATL-4E00S050S	4.56	ATL-4E00S050V	21.01
6"	ATL-4E00S060S	5.65	ATL-4E00S060V	22.16
7"	ATL-4E00S070S	5.73	ATL-4E00S070V	31.32
8"	ATL-4E00S080S	6.98	ATL-4E00S080V	31.42
10"	ATL-4E00S100S	8.09	ATL-4E00S100V	34.99
12"	ATL-4E00S120S	9.34	ATL-4E00S120V	42.20
14"	ATL-4E00S140S	47.24	ATL-4E00S140V	84.71

ATLAS

Series H Piston Seal Kits

Series H Piston Seal Kits

Nitrile



Kit Includes:

- * See notes below
- 2 NBR Loaded URE U-Seals
- 1 Nylon Wear Ring
- 2 NBR O-Ring Head Seals
- 2 PTFE Back-up Rings

Fluorocarbon

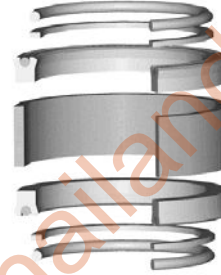

Kit Includes:

- * See notes below
- 2 FC Loaded FC U-Seals
- 1 Nylon Wear Ring
- 2 FC O-Ring Head Seals
- 2 PTFE Back-Up Rings

Bore Dia.	(NBR) Kit #	List Price	(FC) Kit #	List Price
1-1/2"	ATL-1B00S015S	\$ 11.12	ATL-1B00S015V	\$ 33.72
2"	ATL-1B00S020S	12.97	ATL-1B00S020V	37.53
2-1/2"	ATL-1B00S025S	13.84	ATL-1B00S025V	39.83
3-1/4"	ATL-1B00S032S	21.31	ATL-1B00S032V	56.90
4"	ATL-1B00S040S	27.34	ATL-1B00S040V	82.00
5"	ATL-1B00S050S	57.46	ATL-1B00S050V	123.47
6"	ATL-1B00S060S	98.45	ATL-1B00S060V	167.58
7"	ATL-1B00S070S	128.63	ATL-1B00S070V	257.37
8"	ATL-1B00S080S	136.54	ATL-1B00S080V	270.23
10"	ATL-1B00S100S	178.49	ATL-1B00S100V	358.13
12"	ATL-1B00S120S	226.81	ATL-1B00S120V	439.78

* Kit contents are size dependant:
 1-1/2" thru 4" - U-Seals and O-Rings
 5" - U-Seals, O-Rings and Wear Rings
 6" - Same as 5, also includes 2 PTFE U-Seal Back-Up Rings
 7" thru 12" - contain all parts listed

ATLAS

Series H Head Seal Kits

Nitrile

Series H Head Seal Kits

Fluorocarbon

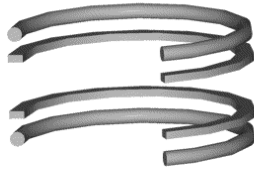

Kit Includes:
2 NBR O-Ring Head Seals
2 PTFE Back-up Rings*

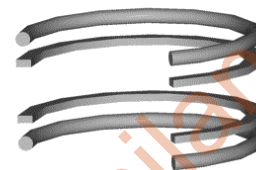

Kit Includes:
2 FC O-Ring Head Seals
2 PTFE Back-up Rings*

Bore Dia.	(NBR) Kit #	List Price	(FC) Kit #	List Price
1-1/2"	ATL-1E00S015S	\$ 2.71	ATL-1E00S015V	\$ 4.03
2"	ATL-1E00S020S	3.48	ATL-1E00S020V	4.79
2-1/2"	ATL-1E00S025S	4.66	ATL-1E00S025V	5.76
3-1/4"	ATL-1E00S032S	8.69	ATL-1E00S032V	11.37
4"	ATL-1E00S040S	10.52	ATL-1E00S040V	12.31
5"	ATL-1E00S050S	12.61	ATL-1E00S050V	19.14
6"	ATL-1E00S060S	19.80	ATL-1E00S060V	20.67
7"	ATL-1E00S070S	41.92	ATL-1E00S070V	48.75
8"	ATL-1E00S080S	44.59	ATL-1E00S080V	56.88
10"	ATL-1E00S100S	81.08	ATL-1E00S100V	91.32
12"	ATL-1E00S120S	92.14	ATL-1E00S120V	105.13

* Back-up Rings in 7", 8", 10" and 12" kits only

ATLAS

Rod Kits

Hydraulic Cylinders

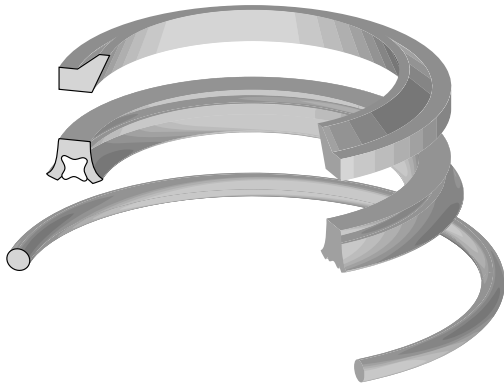

Rod Dia.	Kit #	List Price
5/8"	ATL-HRK62	\$ 5.76
1"	ATL-HRK100	6.90
1-3/8"	ATL-HRK137	8.01
1-3/8"	ATL-90030340-79	9.34
1-3/8"	ATL-90030370-79	7.66
1-3/4"	ATL-HRK175	8.84
1-3/4"	ATL-90030340-69	8.35
1-3/4"	ATL-90030370-69	8.28
2"	ATL-HRK200	9.47

Kit Includes:

- 1 URE Wiper
- 1 URE Loaded U-seal
- 1 NBR O-ring

Piston Kits

Pneumatic Cylinders

Hydraulic Cylinders

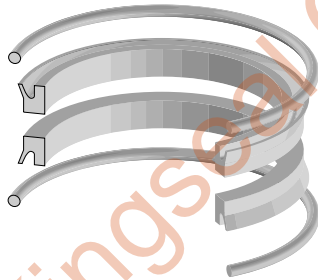
**Kit Includes:**

- 2 URE U-seals
- 2 NBR O-rings

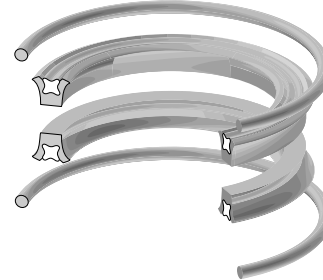
**Kit Includes:**

- 2 URE Loaded U-seals
- 2 NBR O-rings

Bore Dia.	Kit #	List Price	Kit #	List Price
1-1/2"	—		ATL-HPK15-000	\$ 10.21
2"	ATL-APK20-000	\$ 8.71	ATL-HPK20-000	11.44
2-1/2"	ATL-APK25-000	9.21	ATL-HPK25-000	12.43
3-1/4"	—		ATL-HPK35-000	18.61
4"	ATL-APK40-000	20.71	ATL-HPK40-000	22.45
5"	ATL-APK50-000	25.54	ATL-HPK50-000	27.89
6"	ATL-APK60-000	30.11	ATL-HPK60-000	33.33
8"	ATL-APK80-000	40.63	ATL-HPK80-000	67.83
10"	ATL-APK100-000	51.09	—	

HYDRO-LINE

Kit Type		Page
A5 Series	Rod Kits	12
	Piston Kits	13
	Tube End Seals	13
E2 Series	Rod Kits	14
	Piston Kits	14
	Tube End Seals	14
N2 Series	Rod Kits	15
	Piston Kits	16
	Tube End Seals	17
N5 Series	Rod Kits	18 - 19
	Piston Kits	20
	Tube End Seals	20
R2 Series	Rod Kits	21
	Piston Kits	22
	Tube End Seals	23
R5 Series	Rod Kits	24 - 25
	Piston Kits	26
	Tube End Seals	27
Universal Kits	Rod Kits	28
	Gland Kits	29
	Captive Cushion Adjustment Seal	30
	Piston Kits	31



KINGSEAL CO., LTD. THAILAND

46/152-153 Moo 3 Sri Saman Road
Baan Mai Pakkret, Nonthaburi Thailand 11120

Tel: +662 9617534 to 6

Fax: +662 9617540

Email: intlsales@kingseal.co.th / kingsealmail@gmail.com

Website: <http://www.kingseal.co.th>

HYDRO-LINE

A5 Series
Rod Kits

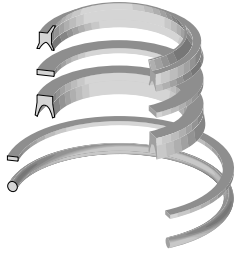
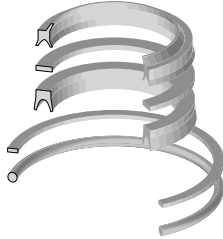
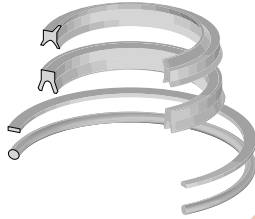
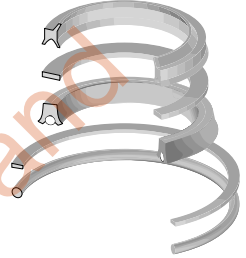
	A5 Cylinders		HA5 Cylinders					
	Nitrile	Fluorocarbon	Urethane	Fluorocarbon				
								
	Kit Includes: 1 XNBR Wiper 1 URE Back-up Ring 1 NBR U-seal 1 PTFE Back-up Ring 1 NBR O-ring	Kit Includes: 1 FC Wiper 1 PTFE Back-up Ring 1 FC U-seal 1 PTFE Back-up Ring 1 FC O-ring	Kit Includes: 1 XNBR Wiper 1 URE U-seal 1 PTFE Back-up Ring 1 NBR O-ring	Kit Includes: 1 FC Wiper 1 PTFE Back-up Ring 1 FC Loaded U-seal 1 PTFE Back-up Ring 1 FC O-ring				
Rod Dia.	(NBR) Kit #	List Price	(FC) Kit #	List Price	(URE) Kit #	List Price	(FC) Kit #	List Price
5/8"	HSKN5-660-05	\$ 6.33	HSKN5-660-05V	\$ 22.74	HSKN5-681-05	\$ 10.67	HSKN5-660-P-05V	\$ 38.26
1"	HSKN5-660-08	6.44	HSKN5-660-08V	23.90	HSKN5-681-08	11.71	HSKN5-660-P-08V	43.43
1-3/8"	HSKN5-660-11	8.07	HSKN5-660-11V	31.24	HSKN5-681-11	13.04	HSKN5-660-P-11V	53.21



KINGSEAL CO., LTD. THAILAND

46/152-153 Moo 3 Sri Saman Road
 Baan Mai Pakkret, Nonthaburi Thailand 11120

Tel: +662 9617534 to 6

Fax: +662 9617540

Email: intlsales@kingseal.co.th / kingsealmail@gmail.com

Website: <http://www.kingseal.co.th>

HYDRO-LINE

A5 Series Piston Kits

HYDRO-LINE

Nitrile

A5 Cylinders

Fluorocarbon

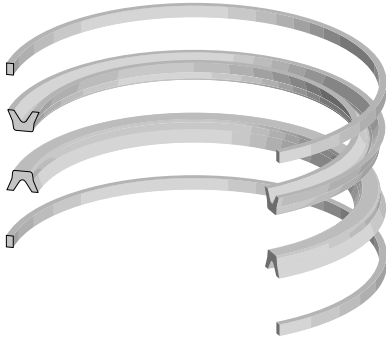

Kit Includes:
2 NBR U-seals
2 PTFE Tube End Seals



Kit Includes:
2 FC U-seals
2 PTFE Tube End Seals

Bore Dia.	(NBR) Kit #	List Price	(FC) Kit #	List Price
1-1/2"	HSKA5-512-03	\$ 16.66	HSKA5-512-03V	\$ 33.72
2"	HSKA5-512-04	17.76	HSKA5-512-04V	34.94
2-1/2"	HSKA5-512-05	19.13	HSKA5-512-05V	41.21
3-1/4"	HSKA5-512-065	20.64	HSKA5-512-065V	46.47
4"	HSKA5-512-08	24.02	HSKA5-512-08V	50.50
5"	HSKA5-512-10	30.02	HSKA5-512-10V	59.23
6"	HSKA5-512-12	35.35	HSKA5-512-12V	96.93

Tube End Seals

A5 Cylinders PTFE

Bore Dia.	Part #	List Price
1-1/2"	HS-C221-03	\$ 4.90
2"	HS-C221-04	5.33
2-1/2"	HS-C221-05	5.89
3-1/4"	HS-C221-065	6.35
4"	HS-C221-08	7.17
5"	HS-C221-10	9.70
6"	HS-C221-12	12.49

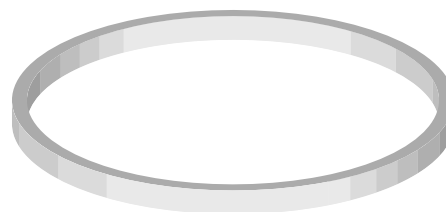

HYDRO-LINE

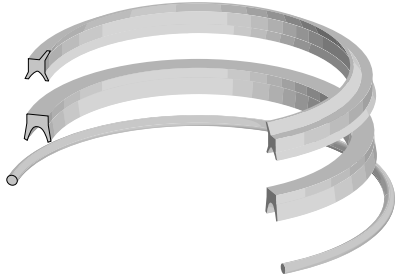
E2 Series
Rod KitsE2 Cylinders
Nitrile

Rod Dia.	(NBR) Kit #	List Price
5/8"	HSKE2-660-05	\$ 2.81
1"	HSKE2-660-08	3.13
1-3/8"	HSKE2-660-11	3.48

Kit Includes:

- 1 XNBR Wiper
- 1 NBR U-seal
- 1 NBR O-ring

Piston Kits

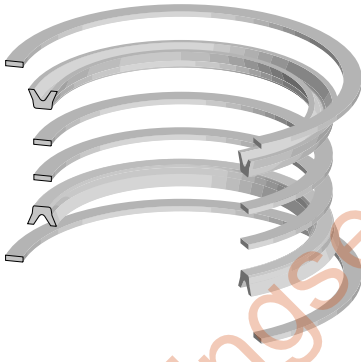
E2 Cylinders
Nitrile

Bore Dia.	(NBR) Kit #	List Price
1-1/2"	HSKE2-512-03	\$ 11.47
2"	HSKE2-512-04	16.92
3-1/4"	HSKE2-512-065	16.26
4"	HSKE2-512-08	28.36

Kit Includes:

- 2 NBR U-seals
- 2 PTFE Back-up Rings (found in 2" & 4" Bore Kits Only)
- 2 Fiber Gaskets

Tube End Seals

E2 Cylinders
Fiber

Bore Dia.	Part #	List Price
1-1/2"	HS-E304-03	\$ 1.64
2"	HS-E304-04	1.71
3-1/4"	HS-E304-065	1.90
4"	HS-E304-08	2.16

HYDRO-LINE

N2 Series Rod Kits

HYDRO-LINE

N2 Cylinders

Nitrile

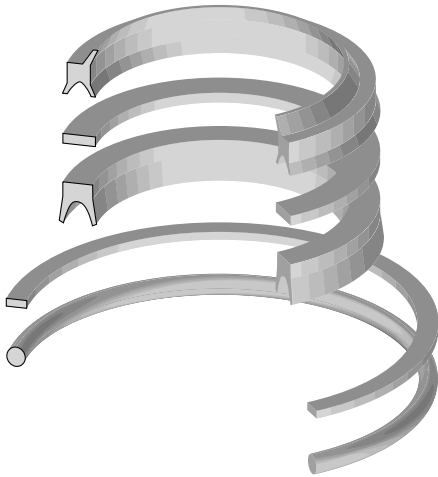

Kit Includes:

- 1 XNBR Wiper
- 1 URE Back-up Ring
- 1 NBR U-seal
- 1 PTFE Back-up Ring
- 1 NBR O-ring

Fluorocarbon

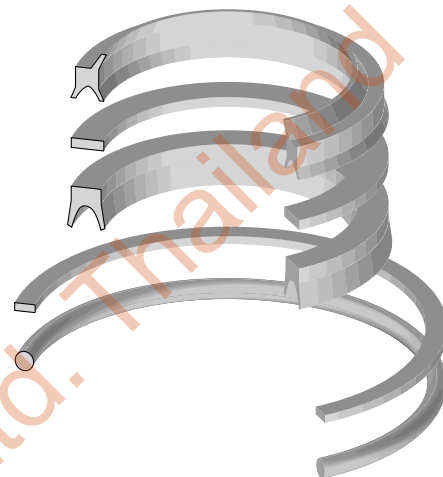

Kit Includes:

- 1 FC Wiper
- 1 PTFE Back-up Ring
- 1 FC U-seal
- 1 PTFE Back-up Ring
- 1 FC O-ring

Rod Dia.	(NBR) Kit #	List Price	(FC) Kit #	List Price
5/8"	HSKN2-661-05	\$ 6.36	HSKN2-661-05V	\$ 23.54
1"	HSKN2-661-08	6.31	HSKN2-661-08V	24.99
1-3/8"	HSKN2-661-11	7.71	HSKN2-661-11V	27.84
1-3/4"	HSKN2-661-14	9.04	HSKN2-661-14V	32.64
2"	HSKN2-661-16	10.02	HSKN2-661-16V	34.46
2-1/2"	HSKN2-661-20	10.85	HSKN2-661-20V	38.46
3"	HSKN5-660-24	13.04	HSKN5-660-24V	50.77
3-1/2"	HSKN5-660-28	14.31	HSKN5-660-28V	59.32
4"	HSKN5-660-32	17.95	HSKN5-660-32V	61.99
4-1/2"	HSKN5-660-36	19.35	HSKN5-660-36V	65.44
5"	HSKN5-660-40	28.63	HSKN5-660-40V	78.67
5-1/2"	HSKN5-660-44	39.04	HSKN5-660-44V	88.85

FOR N2 GLAND KITS SEE UNIVERSAL GLAND KITS, SEE PAGE 23

HYDRO-LINE

N2 Series
Piston Kits

Nitrile

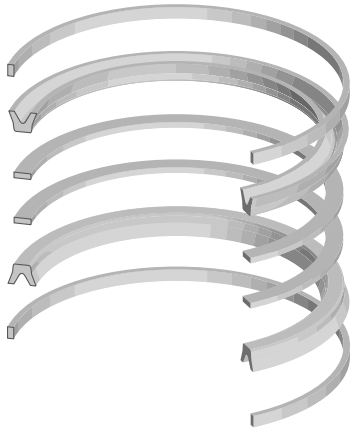
**Kit Includes:**

- 2 NBR U-seals
- 2 URE Back-up Rings
- 2 PTFE Tube End Seals

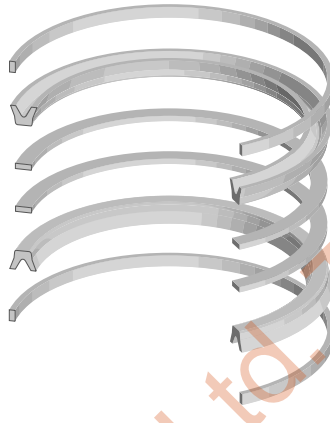
N2 Cylinders
Fluorocarbon**Kit Includes:**

- 2 FC U-seals
- 2 PTFE Back-up Rings
- 2 PTFE Tube End Seals

Piston Ring

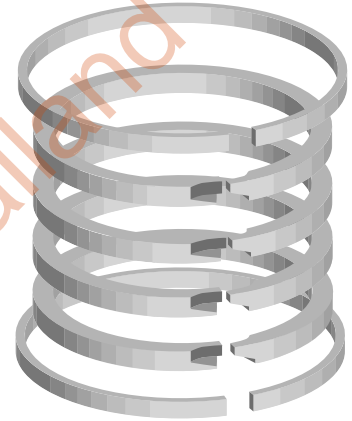
**Kit Includes:**

- 4 Cast-Iron Piston Rings
- 2 PTFE Tube End Seals

Bore Dia.	(NBR) Kit #	List Price	(FC) Kit #	List Price	(PR) Kit #	List Price
1-1/2"	HSKN2-512-03	\$ 21.28	HSKN2-512-03V	\$ 41.42	HSKN2-511-03	\$ 52.83
2"	HSKN2-512-04	25.78	HSKN2-512-04V	54.37	HSKN2-511-04	60.24
2-1/2"	HSKN2-512-05	27.84	HSKN2-512-05V	57.80	HSKN2-511-05	61.20
3-1/4"	HSKN2-512-065	26.75	HSKN2-512-065V	65.70	HSKN2-511-065	64.61
4"	HSKN2-512-08	32.14	HSKN2-512-08V	77.72	HSKN2-511-08	72.73
5"	HSKN2-512-10	41.30	HSKN2-512-10V	86.06	HSKN2-511-10	88.50
6"	HSKN2-512-12	46.41	HSKN2-512-12V	114.33	HSKN2-511-12	93.47
7"	HSKN2-512-14	70.87	HSKN2-512-14V	168.41	HSKN2-511-14	104.69
8"	HSKN2-512-16	89.75	HSKN2-512-16V	186.04	HSKN2-511-16	128.72
10"	HSKN2-512-20	100.92	HSKN2-512-20V	346.10	HSKN2-511-20	268.83
12"	HSKN2-512-24	158.63	HSKN2-512-24V	513.15	HSKN2-511-24	363.64

HYDRO-LINE

N2 Series Tube End Seals

N2 Cylinders PTFE

HYDRO-LINE

Bore Dia.	Part #	List Price
1-1/2"	HS-C124-03	\$ 6.02
2"	HS-C124-04	7.32
2-1/2"	HS-C124-05	8.48
3-1/4"	HS-C124-065	10.73
4"	HS-C124-08	11.53
5"	HS-C124-10	12.68
6"	HS-C124-12	13.10
7" & UP	HS-C124-STRIP (sold by the foot)	8.52/ft



KINGSEAL CO., LTD. THAILAND

46/152-153 Moo 3 Sri Saman Road
Baan Mai Pakkret, Nonthaburi Thailand 11120

Tel: +662 9617534 to 6

Fax: +662 9617540

Email: intlsales@kingseal.co.th / kingsealmail@gmail.com

Website: <http://www.kingseal.co.th>

HYDRO-LINE

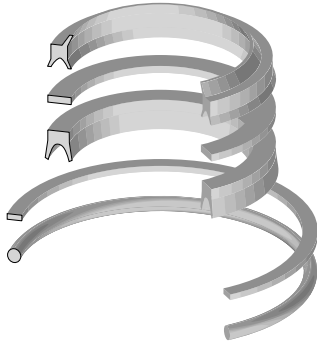
N5 Series
Rod KitsN5 & AN5 Cylinders
Nitrile**Kit Includes:**

- 1 XNBR Wiper
- 1 URE Back-up Ring
- 1 NBR U-seal
- 1 PTFE Back-up Ring
- 1 NBR O-ring

Rod Dia.	(NBR) Kit #	List Price
5/8"	HSKN5-660-05	\$ 6.33
1"	HSKN5-660-08	6.44
1-3/8"	HSKN5-660-11	8.07
1-3/4"	HSKN5-660-14	10.19
2"	HSKN5-660-16	11.40
2-1/2"	HSKN5-660-20	12.55
3"	HSKN5-660-24	13.04
3-1/2"	HSKN5-660-28	14.31
4"	HSKN5-660-32	17.95
4-1/2"	HSKN5-660-36	19.35
5"	HSKN5-660-40	28.63
5-1/2"	HSKN5-660-44	39.04

Rod Kits

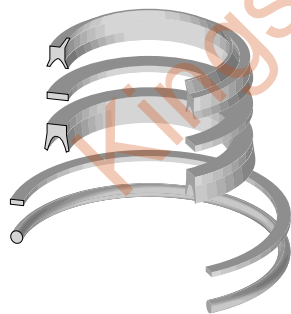
N5 Cylinders
Fluorocarbon**Kit Includes:**

- 1 FC Wiper
- 1 PTFE Back-up Ring
- 1 FC U-seal
- 1 PTFE Back-up Ring
- 1 FC O-ring

Rod Dia.	(FC) Kit #	List Price
5/8"	HSKN5-660-05V	\$ 22.74
1"	HSKN5-660-08V	23.90
1-3/8"	HSKN5-660-11V	31.24
1-3/4"	HSKN5-660-14V	32.39
2"	HSKN5-660-16V	34.51
2-1/2"	HSKN5-660-20V	38.94
3"	HSKN5-660-24V	50.77
3-1/2"	HSKN5-660-28V	59.32
4"	HSKN5-660-32V	61.99
4-1/2"	HSKN5-660-36V	65.44
5"	HSKN5-660-40V	78.67
5-1/2"	HSKN5-660-44V	88.85

HYDRO-LINE

N5 Series Rod Kits

HYDRO-LINE

Urethane

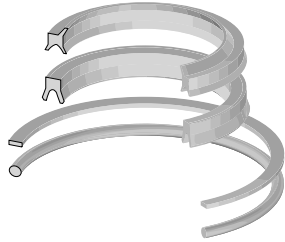

Kit Includes:

- 1 XNBR Wiper
- 1 URE U-seal
- 1 PTFE Back-up Ring
- 1 NBR O-ring

N5 Cylinders Urethane

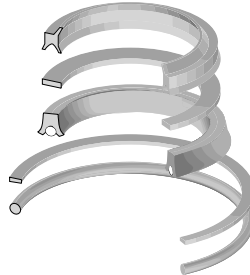

Kit Includes:

- 1 XNBR Wiper
- 1 Urethane Back-up Ring
- 1 Urethane Loaded U-seal
- 1 PTFE Back-up Ring
- 1 NBR O-ring

Fluorocarbon

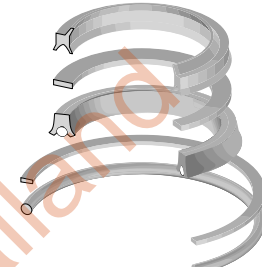

Kit Includes:

- 1 FC Wiper
- 1 PTFE Back-up Ring
- 1 FC Loaded U-seal
- 1 PTFE Back-up Ring
- 1 FC O-ring

Rod Dia.	(URE) Kit #	List Price	(URE) Kit #	List Price	(FC) Kit #	List Price
1/2"	—	—	HSKN5-660-P-04	\$ 8.98	—	—
5/8"	HSKN5-681-05	\$ 10.67	—	—	HSKN5-660-P-05V	\$ 38.26
1"	HSKN5-681-08	11.71	HSKN5-660-P-08	9.97	HSKN5-660-P-08V	43.43
1-3/8"	HSKN5-681-11	13.04	—	—	HSKN5-660-P-11V	53.21
1-3/4"	HSKN5-681-14	13.95	HSKN5-660-P-14	12.38	HSKN5-660-P-14V	58.64
2"	HSKN5-681-16	18.16	—	—	HSKN5-660-P-16V	61.07
2-1/2"	HSKN5-681-20	25.58	—	—	HSKN5-660-P-20V	89.05
3"	HSKN5-681-24	27.89	—	—	HSKN5-660-P-24V	102.56
3-1/2"	HSKN5-681-28	30.55	HSKN5-660-P-28	22.91	HSKN5-660-P-28V	114.52
4"	HSKN5-681-32	35.83	—	—	HSKN5-660-P-32V	138.30
4-1/2"	HSKN5-681-36	47.06	—	—	HSKN5-660-P-36V	148.33
5"	HSKN5-681-40	49.29	—	—	HSKN5-660-P-40V	152.05
5-1/2"	HSKN5-681-44	58.66	—	—	HSKN5-660-P-44V	155.46

FOR N5 GLAND KITS SEE UNIVERSAL GLAND KITS, SEE PAGE 23

HYDRO-LINE

N5 Series
Piston Kits

N5 Cylinders

Nitrile

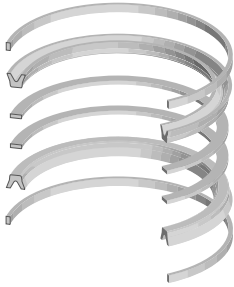
**Kit Includes:**

2 NBR U-seals
2 URE Back-up Rings
2 PTFE Tube End Seals

Fluorocarbon

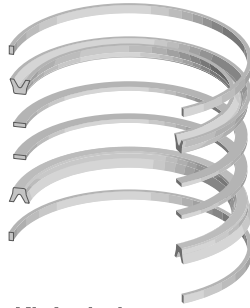
**Kit Includes:**

2 FC U-seals
2 PTFE Back-up Rings
2 PTFE Tube End Seals

Urethane

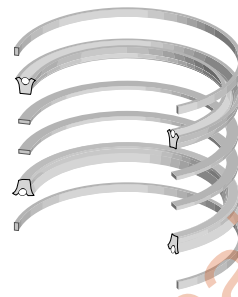
**Kit Includes:**

2 Urethane U-seals
2 URE Back-up Rings
2 PTFE Tube End Seals

Piston Ring

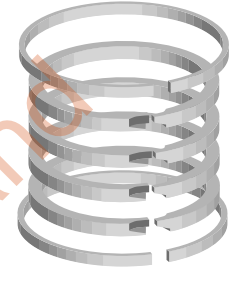
**Kit Includes:**

4 Cast-Iron Piston Rings
2 PTFE Tube End Seals

Bore Dia.	(NBR) Kit #	List Price	(FC) Kit #	List Price	(URE) Kit #	List Price	(PR) Kit #	List Price
1-1/2"	HSKN5-512-03	\$ 16.54	HSKN5-512-03V	\$ 41.06			HSKN5-511-03	\$ 52.47
2"	HSKN5-512-04	22.74	HSKN5-512-04V	56.84			HSKN5-511-04	57.20
2-1/2"	HSKN5-512-05	24.33	HSKN5-512-05V	57.80	HSKN5-512-P-05	\$ 27.71	HSKN5-511-05	57.67
3-1/4"	HSKN5-512-065	26.75	HSKN5-512-065V	60.36			HSKN5-511-065	59.43
4"	HSKN5-512-08	32.08	HSKN5-512-08V	78.13			HSKN5-511-08	68.12
5"	HSKN5-512-10	39.11	HSKN5-512-10V	91.76			HSKN5-511-10	82.91
6"	HSKN5-512-12	40.70	HSKN5-512-12V	108.63			HSKN5-511-12	93.47
7"	HSKN5-512-14	76.98	HSKN5-512-14V	155.04			HSKN5-511-14	110.46
8"	HSKN5-512-16	107.96	HSKN5-512-16V	174.57	HSKN5-512-P-16	138.72	HSKN5-511-16	140.17
10"	HSKN2-512-20	100.92	HSKN2-512-20V	346.10			HSKN2-511-20	268.83
12"	HSKN2-512-24	158.63	HSKN2-512-24V	513.15			HSKN2-511-24	363.64

Tube End Seals

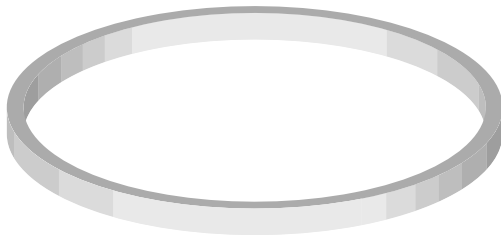
N5 Cylinders
PTFE

Bore Dia.	Part #	List Price
1-1/2"	HS-C255-03	\$ 6.47
2"	HS-C255-04	7.48
2-1/2"	HS-C255-05	7.89
3-1/4"	HS-C255-065	8.13
4"	HS-C255-08	9.22
5"	HS-C255-10	9.83
6"	HS-C255-12	10.25
7"	HS-C255-14	10.73
8"	HS-C255-16	12.48
10" & UP	HS-C124-STRIP (sold by the foot)	8.32/ft.

HYDRO-LINE

R2 Series Rod Kits

HYDRO-LINE

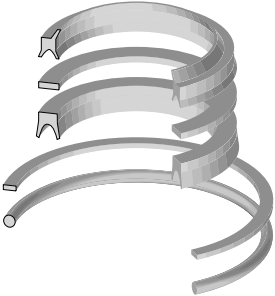
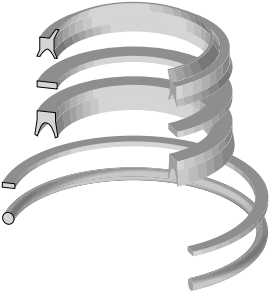
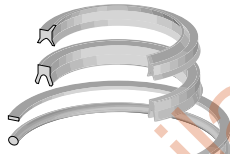
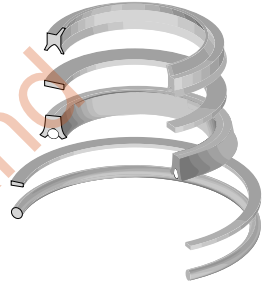
R2 & LR2 Cylinders									
		Nitrile		Fluorocarbon		Urethane		Fluorocarbon	
									
		Kit Includes: 1 XNBR Wiper 1 URE Back-up Ring 1 NBR U-seal 1 PTFE Back-up Ring 1 NBR O-ring		Kit Includes: 1 FC Wiper 1 PTFE Back-up Ring 1 FC U-seal 1 PTFE Back-up Ring 1 FC O-ring		Kit Includes: 1 XNBR Wiper 1 URE U-seal 1 PTFE Back-up Ring 1 NBR O-ring		Kit Includes: 1 FC Wiper 1 PTFE Back-up Ring 1 FC Loaded U-seal 1 PTFE Back-up Ring 1 FC O-ring	
Rod Dia.	Bore Dia.	(NBR) Kit #	List Price	(FC) Kit #	List Price	(URE) Kit #	List Price	(FC) Kit #	List Price
5/8"	1"	HSKR2-662-05A	\$ 5.58	HSKR2-662-05AV	\$ 23.47	HSKR2-681-05A	\$ 9.31	HSKR2-662-P-05AV	\$ 36.23
5/8"	1.5" & UP	HSKN2-661-05	6.36	HSKN2-661-05V	23.54	—	—	—	—
1"	1.5", 2.5"	HSKR2-662-08	6.07	HSKR2-662-08V	23.96	HSKR2-681-08	11.56	HSKR2-662-P-08V	43.79
1"	3.25" & UP	HSKN2-661-08	6.31	HSKN2-661-08V	24.99	—	—	—	—
1-3/8"	2", 2.5"	HSKR2-662-11	7.40	HSKR2-662-11V	30.88	HSKR2-681-11	11.71	HSKR2-662-P-11V	52.57
1-3/8"	3.25" & UP	HSKN2-661-11	7.71	HSKN2-661-11V	27.84	—	—	—	—
1-3/4"	2.5"	HSKR2-662-14	9.09	HSKR2-662-14V	31.73	HSKR2-681-14	12.22	HSKR2-662-P-14V	58.86
1-3/4"	3.25" & UP	HSKN2-661-14	9.04	HSKN2-661-14V	32.64	—	—	—	—
2"	ALL	HSKN2-661-16	10.02	HSKN2-661-16V	34.46	—	—	—	—
2-1/2"	ALL	HSKN2-661-20	10.85	HSKN2-661-20V	38.46	—	—	—	—
3"	ALL	HSKN5-660-24	13.04	HSKN5-660-24V	50.77	—	—	—	—
3-1/2"	ALL	HSKN5-660-28	14.31	HSKN5-660-28V	59.32	—	—	—	—
4"	ALL	HSKN5-660-32	17.95	HSKN5-660-32V	61.99	—	—	—	—
4-1/2"	ALL	HSKN5-660-36	19.35	HSKN5-660-36V	65.44	—	—	—	—
5"	ALL	HSKN5-660-40	28.63	HSKN5-660-40V	78.67	—	—	—	—
5-1/2"	ALL	HSKN5-660-44	39.04	HSKN5-660-44V	88.85	—	—	—	—

FOR R2 GLAND KITS SEE UNIVERSAL GLAND KITS, SEE PAGE 23

HYDRO-LINE

R2 Series
Piston Kits

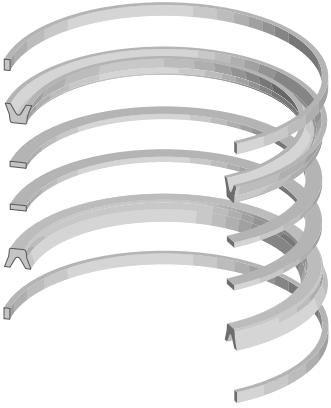
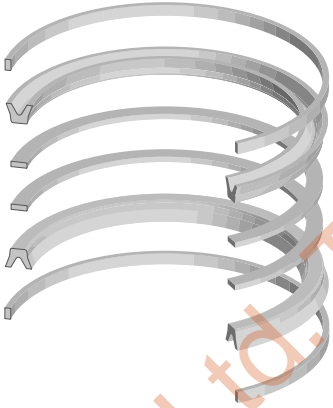
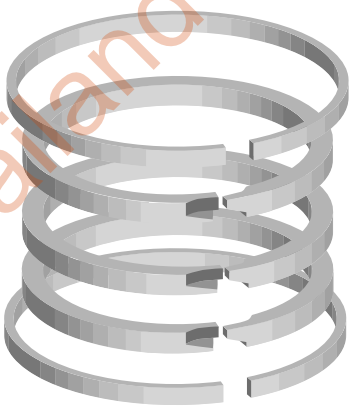
		R2 & LR2 Cylinders				
		Nitrile	Fluorocarbon	Piston Ring		
						
		<p>Kit Includes: 2 NBR U-seals 2 URE Back-up Rings 2 PTFE Tube End Seals</p>	<p>Kit Includes: 2 FC U-seals 2 PTFE Back-up Rings 2 PTFE Tube End Seals</p>	<p>Kit Includes: 3 Cast-Iron Piston Rings 2 PTFE Tube End Seals</p>		
Bore Dia.	(NBR) Kit #	List Price	(FC) Kit #	List Price	(PR) Kit #	List Price
1"	HSKR5-512-02	\$ 17.06	HSKR5-512-02V	\$ 36.44	HSKR5-511-02	\$ 56.86
1-1/2"	HSKR5-512-03	18.02	HSKR5-512-03V	38.15	HSKR5-511-03	38.15
2"	HSKR5-512-04	19.72	HSKR5-512-04V	53.81	HSKR5-511-04	39.28
2-1/2"	HSKR5-512-05	21.53	HSKR5-512-05V	55.01	HSKR5-511-05	39.93
3-1/4"	HSKR5-512-065	23.90	HSKR5-512-065V	57.56	HSKR5-511-065	46.22
4"	HSKR5-512-08	28.03	HSKR5-512-08V	74.00	HSKR5-511-08	52.10
5"	HSKR5-512-10	35.49	HSKR5-512-10V	82.43	HSKR5-511-10	67.38
6"	HSKR5-512-12	39.61	HSKR5-512-12V	107.55	HSKR5-511-12	74.67
8"	HSKR5-512-16	103.04	HSKR5-512-16V	204.17	HSKR5-511-16	87.90
10"	HSKR5-512-20	100.92	HSKR5-512-20V	346.10	HSKR5-511-20	250.38
12"	HSKR5-512-24	158.63	HSKR5-512-24V	513.15	HSKR5-511-24	348.35
14"	HSKR5-512-28	228.19	HSKR5-512-28V	559.87	—	—

HYDRO-LINE

R2 Series Tube End Seals

HYDRO-LINE

R2 & LR2 Cylinders PTFE

Bore Dia.	Part #	List Price
1"	HS-C221-02	\$ 4.57
1-1/2"	HS-C221-03	4.90
2"	HS-C221-04	5.33
2-1/2"	HS-C221-05	5.89
3-1/4"	HS-C221-065	6.35
4"	HS-C221-08	7.17
5"	HS-C221-10	9.70
6"	HS-C221-12	12.49
8" & UP	HS-C221-STRIP (sold by the foot)	5.48/ft



KINGSEAL CO., LTD. THAILAND

46/152-153 Moo 3 Sri Saman Road
Baan Mai Pakkret, Nonthaburi Thailand 11120

Tel: +662 9617534 to 6

Fax: +662 9617540

Email: intlsales@kingseal.co.th / kingsealmail@gmail.com

Website: <http://www.kingseal.co.th>

HYDRO-LINE

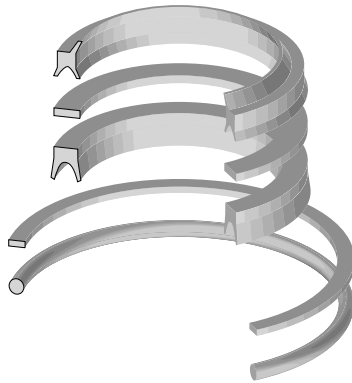
R5 Series
Rod KitsR5 & HR5 Cylinders
Nitrile**Kit Includes:**

- 1 XNBR Wiper
- 1 URE Back-up Ring
- 1 NBR U-seal
- 1 PTFE Back-up Ring
- 1 NBR O-ring

Rod Dia.	Bore Dia.	(NBR) Kit #	List Price
1/2"	1"	HSKN5-660-04	\$ 5.17
5/8"	1"	HSKR2-662-05A	5.58
5/8"	1.5" & UP	HSKN5-660-05	6.33
1"	2" & UP	HSKN5-660-08	6.44
1-3/8"	2.5" & UP	HSKN5-660-11	8.07
1-3/4"	ALL	HSKN5-660-14	10.19
2"	ALL	HSKN5-660-16	11.40
2-1/2"	ALL	HSKN5-660-20	12.55
3"	ALL	HSKN5-660-24	13.04
3-1/2"	ALL	HSKN5-660-28	14.31
4"	ALL	HSKN5-660-32	17.95
4-1/2"	ALL	HSKN5-660-36	19.35
5"	ALL	HSKN5-660-40	28.63
5-1/2"	ALL	HSKN5-660-44	39.04

**KINGSEAL CO., LTD. THAILAND**

46/152-153 Moo 3 Sri Saman Road
Baan Mai Pakkret, Nonthaburi Thailand 11120

Tel: +662 9617534 to 6

Fax: +662 9617540

Email: intlsales@kingseal.co.th / kingsealmail@gmail.com

Website: <http://www.kingseal.co.th>

HYDRO-LINE

R5 Series Rod Kits

HYDRO-LINE

HR5 Cylinders

Fluorocarbon

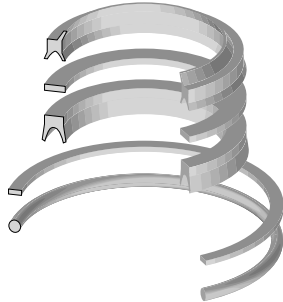

Kit Includes:

- 1 FC Wiper
- 1 PTFE Back-up Ring
- 1 FC U-seal
- 1 PTFE Back-up Ring
- 1 FC O-ring

Urethane

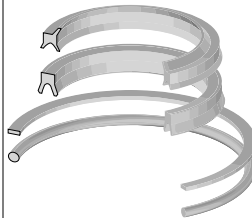

Kit Includes:

- 1 XNBR Wiper
- 1 URE U-seal
- 1 PTFE Back-up Ring
- 1 NBR O-ring

Urethane

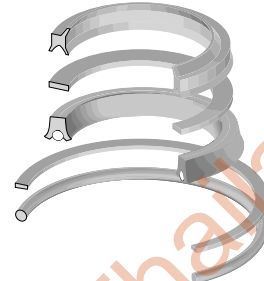

Kit Includes:

- 1 XNBR Wiper
- 1 Urethane Back-up Ring
- 1 Urethane Loaded U-seal
- 1 PTFE Back-up Ring
- 1 NBR O-ring

Fluorocarbon

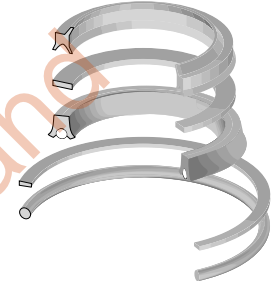

Kit Includes:

- 1 FC Wiper
- 1 PTFE Back-up Ring
- 1 FC Loaded U-seal
- 1 PTFE Back-up Ring
- 1 FC O-ring

Rod Dia.	Bore Dia.	(FC) Kit #	List Price	(URE) Kit #	List Price	(URE) Kit #	List Price	(FC) Kit #	List Price
1/2"	1"	HSKN5-660-04V	\$ 19.05	—	—	HSKN5-660-P-04	\$ 8.98	HSKN5-660-P-04V	\$ 35.99
5/8"	1"	HSKR2-662-05AV	23.48	HSKN5-681-05A	\$ 9.31	—	—	HSKN5-660-P-05AV	36.24
5/8"	1.5" & UP	HSKN5-660-05V	22.74	HSKN5-681-05	10.67	—	—	HSKN5-660-P-05V	38.26
1"	2" & UP	HSKN5-660-08V	23.90	HSKN5-681-08	11.71	HSKN5-660-P-08	9.97	HSKN5-660-P-08V	43.43
1-3/8"	2.5" & UP	HSKN5-660-11V	31.24	HSKN5-681-11	13.04	—	—	HSKN5-660-P-11V	53.21
1-3/4"	ALL	HSKN5-660-14V	32.39	HSKN5-681-14	13.95	HSKN5-660-P-14	12.38	HSKN5-660-P-14V	58.64
2"	ALL	HSKN5-660-16V	34.51	HSKN5-681-16	18.16	—	—	HSKN5-660-P-16V	61.07
2-1/2"	ALL	HSKN5-660-20V	38.94	HSKN5-681-20	25.58	—	—	HSKN5-660-P-20V	89.05
3"	ALL	HSKN5-660-24V	50.77	HSKN5-681-24	27.89	—	—	HSKN5-660-P-24V	102.56
3-1/2"	ALL	HSKN5-660-28V	59.32	HSKN5-681-28	30.55	HSKN5-660-P-28	22.91	HSKN5-660-P-28V	114.52
4"	ALL	HSKN5-660-32V	61.99	HSKN5-681-32	35.83	—	—	HSKN5-660-P-32V	138.30
4-1/2"	ALL	HSKN5-660-36V	65.44	HSKN5-681-36	47.06	—	—	HSKN5-660-P-36V	148.33
5"	ALL	HSKN5-660-40V	78.67	HSKN5-681-40	49.29	—	—	HSKN5-660-P-40V	152.05
5-1/2"	ALL	HSKN5-660-44V	88.85	HSKN5-681-44	58.66	—	—	HSKN5-660-P-44V	155.46

FOR R5 GLAND KITS SEE UNIVERSAL GLAND KITS, PAGE 23

HYDRO-LINE

R5 Series
Piston Kits

Nitrile

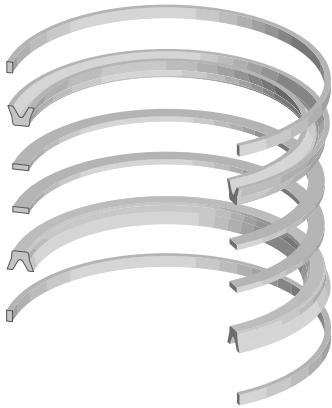
**Kit Includes:**

2 NBR U-seals
2 URE Back-up Rings
2 PTFE Tube End Seals

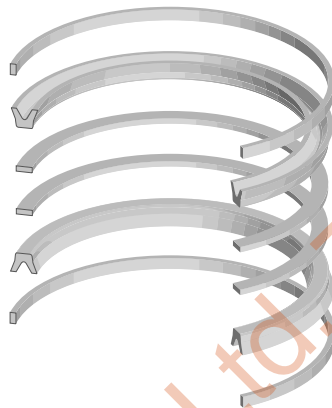
R5 Cylinders
Fluorocarbon**Kit Includes:**

2 FC U-seals
2 PTFE Back-up Rings
2 PTFE Tube End Seals

Piston Ring

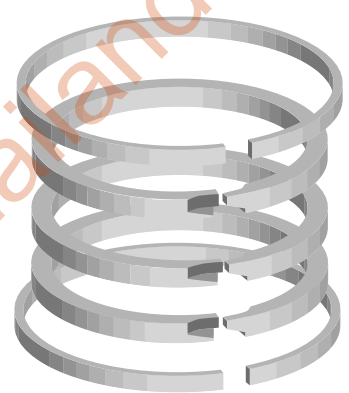
**Kit Includes:**

3 Cast-Iron Piston Rings
2 PTFE Tube End Seals

Bore Dia.	(NBR) Kit #	List Price	(FC) Kit #	List Price	(PR) Kit #	List Price
1"	HSKR5-512-02	\$ 17.06	HSKR5-512-02V	\$ 36.44	HSKR5-511-02	\$ 56.86
1-1/2"	HSKR5-512-03	18.02	HSKR5-512-03V	38.15	HSKR5-511-03	38.15
2"	HSKR5-512-04	19.72	HSKR5-512-04V	53.81	HSKR5-511-04	39.28
2-1/2"	HSKR5-512-05	21.53	HSKR5-512-05V	55.01	HSKR5-511-05	39.93
3-1/4"	HSKR5-512-065	23.90	HSKR5-512-065V	57.56	HSKR5-511-065	46.22
4"	HSKR5-512-08	28.03	HSKR5-512-08V	74.00	HSKR5-511-08	52.10
5"	HSKR5-512-10	35.49	HSKR5-512-10V	82.43	HSKR5-511-10	67.38
6"	HSKR5-512-12	39.61	HSKR5-512-12V	107.55	HSKR5-511-12	74.67
8"	HSKR5-512-16	103.04	HSKR5-512-16V	204.17	HSKR5-511-16	87.90
10"	HSKR5-512-20	100.92	HSKR5-512-20V	346.10	HSKR5-511-20	250.38
12"	HSKR5-512-24	158.63	HSKR5-512-24V	513.15	HSKR5-511-24	348.35
14"	HSKR5-512-28	228.19	HSKR5-512-28V	559.87	—	—

HYDRO-LINE

R5 Series Tube End Seals

R5 Cylinders PTFE

Bore Dia.	Part #	List Price
1"	HS-C221-02	\$ 4.57
1-1/2"	HS-C221-03	4.90
2"	HS-C221-04	5.33
2-1/2"	HS-C221-05	5.89
3-1/4"	HS-C221-065	6.35
4"	HS-C221-08	7.17
5"	HS-C221-10	9.70
6"	HS-C221-12	12.49
8" & UP	HS-C221-STRIP (sold by the foot)	5.48/ft



KINGSEAL CO., LTD. THAILAND

46/152-153 Moo 3 Sri Saman Road
Baan Mai Pakkret, Nonthaburi Thailand 11120

Tel: +662 9617534 to 6

Fax: +662 9617540

Email: intlsales@kingseal.co.th / kingsealmail@gmail.com

Website: <http://www.kingseal.co.th>

HYDRO-LINE

UNIVERSAL Rod Kits

A5, N2, N5, R2, & R5 Cylinders (see note)

Nitrile

Fluorocarbon

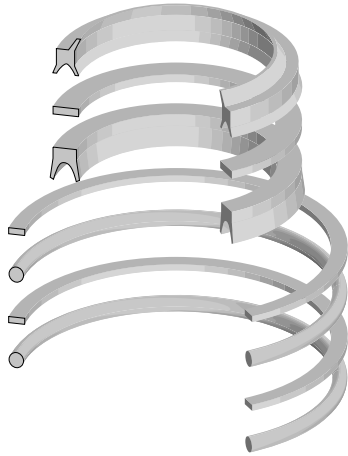

Kit Includes:

- 1 XNBR Wiper
- 1 URE Back-up Ring
- 1 NBR U-seal
- 2 NBR O-rings
- 2 PTFE BU Rings

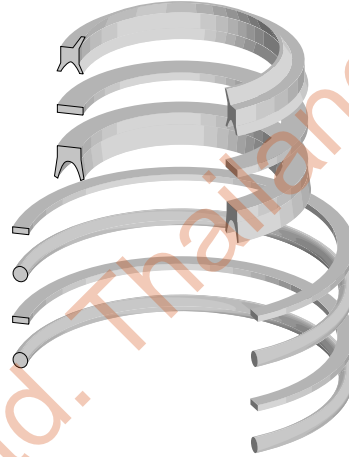

Kit Includes:

- 1 FC Wiper
- 1 PTFE BU Ring
- 1 FC U-seal
- 2 FC O-rings
- 2 PTFE BU Rings

Rod Dia.	(NBR) Kit #	List Price	(FC) Kit #	List Price
5/8"	HSKN25-665-05	\$ 7.34	HSKN25-665-05V	\$ 25.47
1"	HSKN25-665-08	7.64	HSKN25-665-08V	26.51
1-3/8"	HSKN25-665-11	9.76	HSKN25-665-11V	33.66
1-3/4"	HSKN25-665-14	12.32	HSKN25-665-14V	37.79
2"	HSKN25-665-16	13.77	HSKN25-665-16V	40.04
2-1/2"	HSKN25-665-20	15.34	HSKN25-665-20V	45.55

Note: Rod Seal Kits are good for all cylinders except R2/R5 1" Bore X All Rods, 1-1/2" Bore X 1" Rod, and 2" Bore X 1-3/8" Rod.

HYDRO-LINE

UNIVERSAL Gland Kits

HYDRO-LINE

A5, N2, N5, R2, & R5 Cylinders (see note)

Nitrile

Fluorocarbon

Bushing

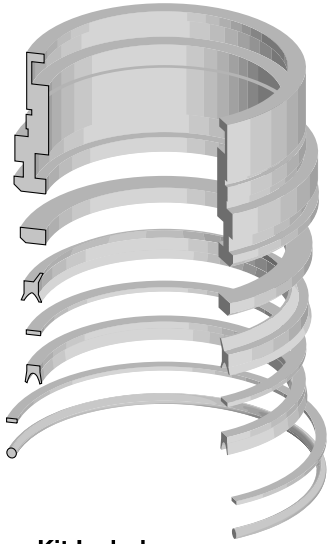

Kit Includes:

- 1 Iron Bushing
- 1 Spacer
- 1 XNBR Wiper
- 1 URE Back-up Ring
- 1 NBR U-seal
- 1 PTFE Back-up ring
- 1 NBR O-ring

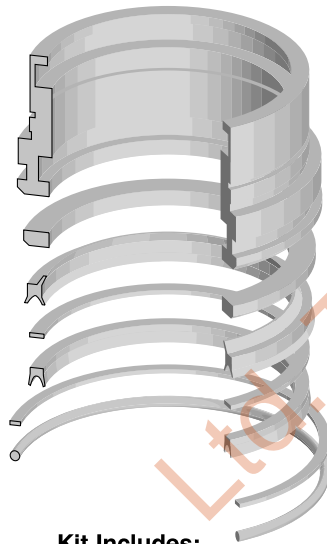

Kit Includes:

- 1 Iron Bushing
- 1 Spacer
- 1 FC Wiper
- 1 PTFE Back-up Ring
- 1 FC U-seal
- 1 PTFE Back-up ring
- 1 FC O-ring

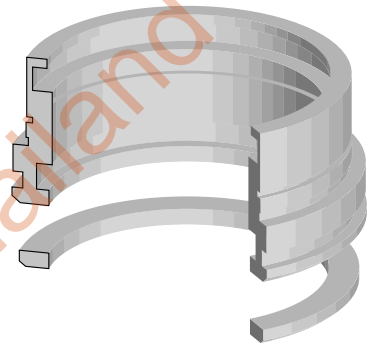

Kit Includes:

- 1 Iron Bushing
- 1 Spacer

Rod Dia.	(NBR) Kit #	List Price	(FC) Kit #	List Price	Part #	List Price
5/8"	HN5-665-05	\$ 85.16	HN5-665-05V	\$ 97.07	HN5-655-05	\$ 81.91
1"	HN5-665-08	105.71	HN5-665-08V	118.62	HN5-655-08	103.11
1-3/8"	HN5-665-11	113.08	HN5-665-11V	129.68	HN5-655-11	109.86
1-3/4"	HN5-665-14	131.48	HN5-665-14V	148.24	HN5-655-14	126.69
2"	HN5-665-16	136.90	HN5-665-16V	156.59	HN5-655-16	132.43
2-1/2"	HN5-665-20	148.58	HN5-665-20V	170.08	HN5-655-20	142.57
3"	HN5-665-24	223.82	HN5-665-24V	261.06	HN5-655-24	212.29
3-1/2"	HN5-665-28	262.03	HN5-665-28V	295.44	HN5-655-28	248.69
4"	HN5-665-32	290.42	HN5-665-32V	336.00	HN5-655-32	272.95
4-1/2"	HN5-665-36 (2.57" HGT)	411.07	HN5-665-36V (2.57" HGT)	459.33	HN5-655-36 (2.57" HGT)	388.20
4-1/2"	HN5-665-36A (1.88" HGT)	411.07	HN5-665-36AV (1.88" HGT)	459.33	HN5-655-36A (1.88" HGT)	388.20
5"	HN5-665-40	494.64	HN5-665-40V	555.94	HN5-655-40	473.11
5-1/2"	HN5-665-44	536.76	HN5-665-44V	616.51	HN5-655-44	509.51

Note: Gland Seal Kits are good for all cylinders with some exceptions.
Call with series, rod & bore size for more information.

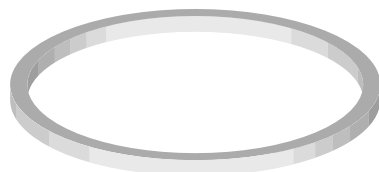
HYDRO-LINE**UNIVERSAL
Captive Cushion Adjustment Seal****A, N & R Cylinders**

Part #	I.D. X C.S.	List Price
HS-C408-1	.204 X .072	\$ 3.64
HS-C408-1V	.204 X .072	4.37
HS-C408-2	.298 X .072	3.64
HS-C408-2V	.298 X .072	4.37
HS-C408-3	.420 X .072	3.64
HS-C408-3V	.420 X .072	4.37
HS-C408-4	.542 X .072	3.64
HS-C408-4V	.542 X .072	4.37

Used on Captive Cushion Adjustment Valves for precise adjustment under pressure over a broad range of operating conditions. Available in both 90A material - Nitrile and Fluorocarbon.

**KINGSEAL CO., LTD. THAILAND**

46/152-153 Moo 3 Sri Saman Road
Baan Mai Pakkret, Nonthaburi Thailand 11120

Tel: +662 9617534 to 6

Fax: +662 9617540

Email: intlsales@kingseal.co.th / kingsealmail@gmail.com

Website: <http://www.kingseal.co.th>

HYDRO-LINE

UNIVERSAL Piston Kits

HYDRO-LINE

Nitrile

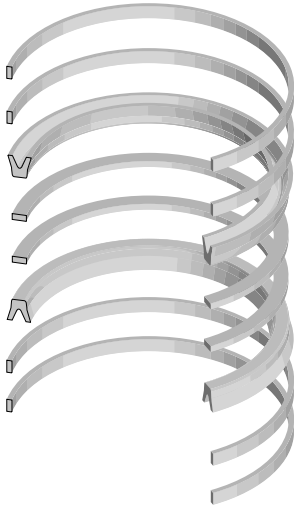

Kit Includes:

2 NBR U-seals
2 URE Back-up Rings
4 PTFE Tube End Seals

N2 & N5 Cylinders Fluorocarbon

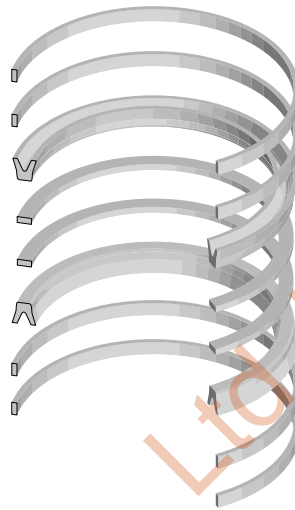

Kit Includes:

2 FC U-seals
2 PTFE Back-up Rings
4 PTFE Tube End Seals

Piston Ring

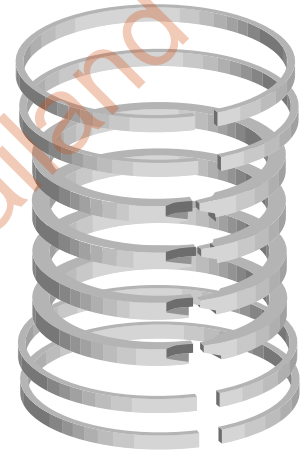

Kit Includes:

4 Cast Iron Piston Rings
4 PTFE Tube End Seals

Bore Dia.	(NBR) Kit #	List Price	(FC) Kit #	List Price	(PR) Kit #	List Price
1-1/2"	HSKN25-512-03	\$ 25.01	HSKN25-512-03V	\$ 49.24	HSKN25-511-03	\$ 67.50
2"	HSKN25-512-04	28.06	HSKN25-512-04V	71.52	HSKN25-511-04	75.53
2-1/2"	HSKN25-512-05	29.26	HSKN25-512-05V	77.09	HSKN25-511-05	76.98
3-1/4"	HSKN25-512-065	38.21	HSKN25-512-065V	81.95	HSKN25-511-065	80.86
4"	HSKN25-512-08	44.99	HSKN25-512-08V	101.18	HSKN25-511-08	91.17
5"	HSKN25-512-10	58.93	HSKN25-512-10V	111.42	HSKN25-511-10	108.28
6"	HSKN25-512-12	66.91	HSKN25-512-12V	165.17	HSKN25-511-12	119.67
7"	HSKN25-512-14	79.28	HSKN25-512-14V	198.35	HSKN25-511-14	119.56
8"	HSKN25-512-16	112.02	HSKN25-512-16V	164.36	HSKN25-511-16	145.58

MILLER

Kit Type		Page
Rod Kit, Iron Gland	Star Bushing - A, J, & H Cylinders	34
	Pneumatic - A & C Cylinders	35
	Hydraulic - AJ, J, M & H Cylinders	36
Star Rod Kits	A, J, & H Cylinders	37
Rod Seal Cage Assembly	Hydraulic	38
Hat Packing	PTFE & Nitrile	39
PTFE Wiper	"U" Style - A, C, J, M, & H Cylinders	39
Iron Gland	Star Bushing Style for A, J, & H Cylinders - Retainer Held & Bolted	40
	A, C, J, M, & H Cylinders - Retainer Held & Bolted	41
Retainer	A, C, J, M, & H Cylinders	42
Caged Assembly Components	Rod Seal Cage, Wave Spring, & Bronze Pressure Ring	42
Piston Kits	A, J, & H Series Cylinders	43
Piston Kits	HV Series Cylinders	44
Piston U-seals	All Current Style Cylinders	44
Wear Rings	Air & Hydraulic Service	45
PTFE Tube Seal Cord	A, C, J, M, & H Cylinders	45
PTFE Tube End Seals	Continuous	46
	Strip	46
Piston Cups	A, AJ, J, JW, H, & HW Cylinders	47
Follower Seals	PTFE	47
Various Kits		47



KINGSEAL CO., LTD. THAILAND

46/152-153 Moo 3 Sri Saman Road
Baan Mai Pakkret, Nonthaburi Thailand 11120

Tel: +662 9617534 to 6

Fax: +662 9617540

Email: intlsales@kingseal.co.th / kingsealmail@gmail.com

Website: <http://www.kingseal.co.th>

MILLER

Star Bushing Rod Kit, Iron Gland

A, J, & H Cylinders

1998 Style Retainer Held

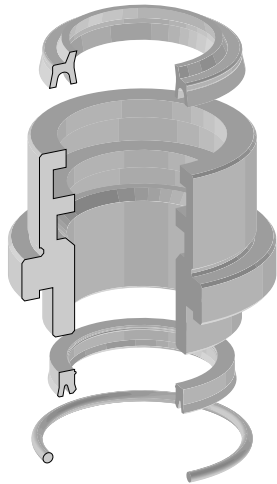
**Kit Includes:**

- 1 XNBR Wiper
- 1 Retainer Held Star Bushing
- 1 URE Rod Seal
- 1 NBR O-ring

1998 Style Bolted

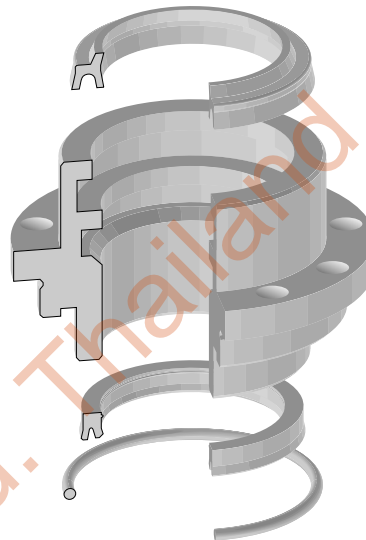
**Kit Includes:**

- 1 XNBR Wiper
- 1 Bolted Star Bushing
- 1 URE Rod Seal
- 1 NBR O-ring

Rod Dia.	Kit #	List Price	Kit #	List Price
5/8"	MLR-051-KR074-063	\$ 104.58	MLR-051-KR075-063	\$ 140.48
1"	MLR-051-KR074-100	130.13	MLR-051-KR075-100	169.43
1-3/8"	MLR-051-KR074-138	153.41	MLR-051-KR075-138	198.60
1-3/4"	—	—	MLR-051-KR075-175	215.22
2"	—	—	MLR-051-KR075-200	253.51
2-1/2"	—	—	MLR-051-KR075-250	348.07
3"	—	—	MLR-051-KR075-300	445.86
3-1/2"	—	—	MLR-051-KR075-350	597.99
4"	—	—	MLR-051-KR075-400	642.93
4-1/2"	—	—	MLR-051-KR075-450	691.96
5"	—	—	MLR-051-KR075-500	921.00
5-1/2"	—	—	MLR-051-KR075-550	1288.61

Bolted bushings from: 5/8" to 1-3/4" have 4 bolt holes
 2" to 4-1/2" have 8 bolt holes
 5" to 5-1/2" have 12 bolt holes

MILLER

Pneumatic Rod Kit, Iron Gland

A & C Cylinders

Retainer Held

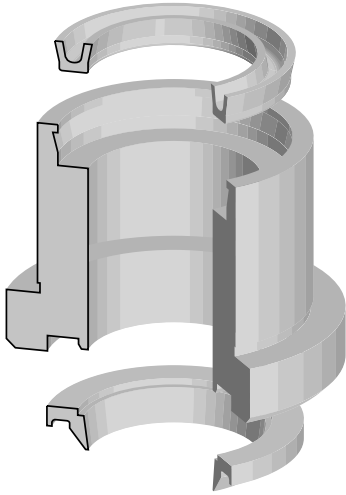

Kit Includes:

- 1 PTFE Wiper
- 1 Retainer Held Iron Gland
- 1 NBR Hat Packing

Bolted

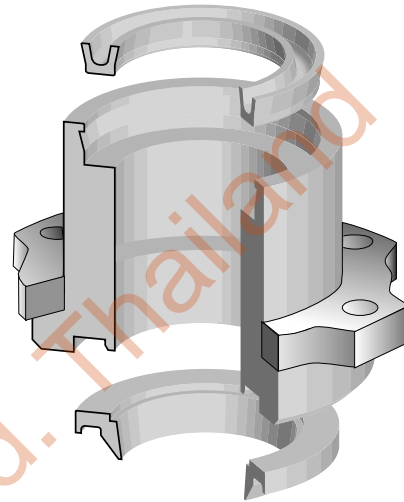

Kit Includes:

- 1 PTFE Wiper
- 1 Bolted Iron Gland
- 1 NBR Hat Packing

Rod Dia.	Kit #	List Price	Kit #	List Price
5/8"	MLR-051-KR010-063	\$ 45.96	MLR-051-KR011-063	\$ 65.04
1"	MLR-051-KR010-100	57.40	MLR-051-KR011-100	79.22
1-3/8"	MLR-051-KR010-138	70.26	MLR-051-KR011-138	97.75
1-3/4"	MLR-051-KR010-175	103.21	MLR-051-KR011-175	145.34
2"	MLR-051-KR010-200	120.72	MLR-051-KR011-200	155.34
2-1/2"	MLR-051-KR010-250	173.70	MLR-051-KR011-250	223.91
3"	MLR-051-KR010-300	226.71	MLR-051-KR011-300	268.73

Bolted bushings from: 5/8" to 1-3/4" have 4 bolt holes
 2" to 4-1/2" have 8 bolt holes
 5" to 5-1/2" have 12 bolt holes

MILLER

Hydraulic Rod Kit, Iron Gland

AJ, J, M, & H Cylinders

Retainer Held

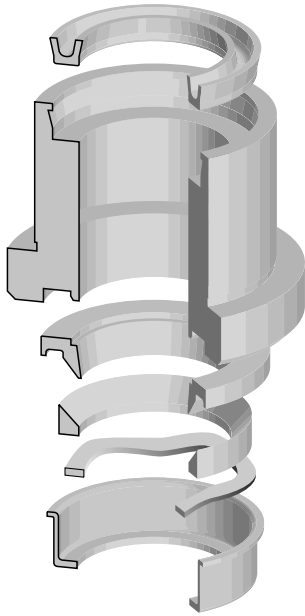
**Kit Includes:**

1 PTFE Wiper
 1 Retainer Held Iron Gland
 1 PTFE Hat Packing
 1 Bronze Pressure Ring
 1 Wave Spring
 1 Cage

Bolted

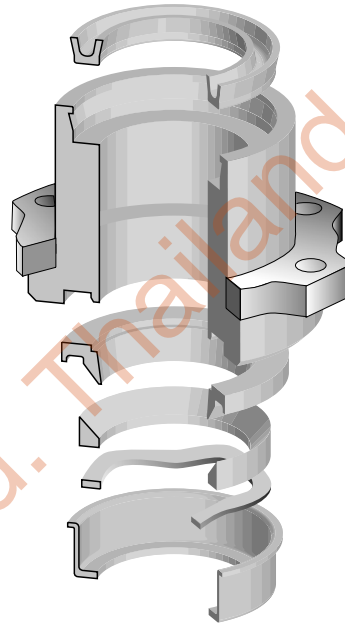
**Kit Includes:**

1 PTFE Wiper
 1 Bolted Iron Gland
 1 PTFE Hat Packing
 1 Bronze Pressure Ring
 1 Wave Spring
 1 Cage

Rod Dia.	Kit #	List Price	Kit #	List Price
5/8"	MLR-051-KR014-063	\$ 82.33	MLR-051-KR015-063	\$101.77
1"	MLR-051-KR014-100	101.48	MLR-051-KR015-100	122.51
1-3/8"	MLR-051-KR014-138	124.75	MLR-051-KR015-138	151.68
1-3/4"	MLR-051-KR014-175	169.00	MLR-051-KR015-175	193.06
2"	MLR-051-KR014-200	203.93	MLR-051-KR015-200	226.96
2-1/2"	MLR-051-KR014-250	251.30	MLR-051-KR015-250	293.46
3"	MLR-051-KR014-300	331.95	MLR-051-KR015-300	366.47

Bolted bushings from: 5/8" to 1-3/4" have 4 bolt holes
 2" to 4-1/2" have 8 bolt holes
 5" to 5-1/2" have 12 bolt holes

MILLER

Star Rod Kits

MILLER

A, J, & H Cylinders Star Kits

Rod Dia.	Kit #	List Price
5/8"	MLR-051-KR080-063	\$ 12.43
1"	MLR-051-KR080-100	21.95
1-3/8"	MLR-051-KR080-138	29.17
1-3/4"	MLR-051-KR080-175	36.15
2"	MLR-051-KR080-200	40.59
2-1/2"	MLR-051-KR080-250	48.46
3"	MLR-051-KR080-300	87.28
3-1/2"	MLR-051-KR080-350	93.53
4"	MLR-051-KR080-400	105.06
4-1/2"	MLR-051-KR080-450	118.76
5"	MLR-051-KR080-500	126.96
5-1/2"	MLR-051-KR080-550	198.40

Kit Includes:
 1 XNBR Wiper
 1 URE Rod Seal
 1 NBR O-ring

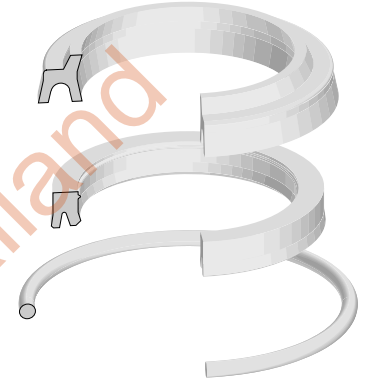

KINGSEAL CO., LTD. THAILAND

46/152-153 Moo 3 Sri Saman Road
 Baan Mai Pakkret, Nonthaburi Thailand 11120

Tel: +662 9617534 to 6

Fax: +662 9617540

Email: intlsales@kingseal.co.th / kingsealmail@gmail.com

Website: <http://www.kingseal.co.th>

MILLER

Hydraulic Rod Seal Cage Assembly

AJ, J, M, & H Cylinders

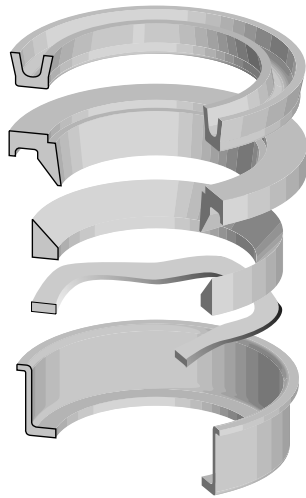
**Kit Includes:**

- 1 PTFE Wiper
- 1 PTFE Hat Packing
- 1 Bronze Pressure Ring
- 1 Wave Spring
- 1 Cage

Boosters & Tandems

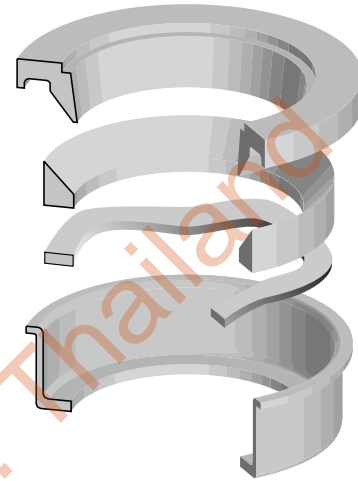
**Kit Includes:**

- 1 PTFE Hat Packing
- 1 Bronze Pressure Ring
- 1 Wave Spring
- 1 Cage
- No Wiper

Rod Dia.	Kit #	List Price	Kit #	List Price
5/8"	MLR-051-KR012-063	\$ 46.35	MLR-051-KR024-063	\$ 42.02
1"	MLR-051-KR012-100	55.48	MLR-051-KR024-100	50.34
1-3/8"	MLR-051-KR012-138	68.71	MLR-051-KR024-138	62.22
1-3/4"	MLR-051-KR012-175	83.44	MLR-051-KR024-175	75.56
2"	MLR-051-KR012-200	97.42	MLR-051-KR024-200	88.43
2-1/2"	MLR-051-KR012-250	121.29	MLR-051-KR024-250	105.63
3"	MLR-051-KR012-300	162.39	MLR-051-KR024-300	144.90

MILLER

Hat Packing

For Hydraulic Service
PTFE

For Air & Water Service
Nitrile

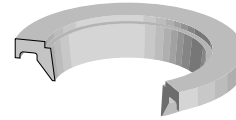
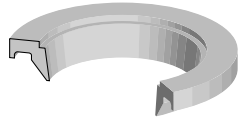

Rod Dia.	Part #	List Price	Part #	List Price
5/8"	MLR-051-RS007-063	\$ 6.01	MLR-051-RS014-063	\$ 4.74
1"	MLR-051-RS007-100	7.73	MLR-051-RS014-100	6.24
1-3/8"	MLR-051-RS007-138	9.09	MLR-051-RS014-138	7.73
1-3/4"	MLR-051-RS007-175	9.58	MLR-051-RS014-175	9.76
2"	MLR-051-RS007-200	9.91	MLR-051-RS014-200	12.06
2-1/2"	MLR-051-RS007-250	12.70	MLR-051-RS014-250	15.84
3"	MLR-051-RS007-300	17.69	MLR-051-RS014-300	17.47
3-1/2"	MLR-051-RS007-350	22.55	MLR-051-RS014-350	25.06
4"	MLR-051-RS007-400	24.26	MLR-051-RS014-400	29.80
4-1/2"	MLR-051-RS007-450	28.24	MLR-051-RS014-450	34.40
5"	MLR-051-RS007-500	30.38	MLR-051-RS014-500	39.07
5-1/2"	MLR-051-RS007-550	35.67	MLR-051-RS014-550	43.67

PTFE Wiper "U" Style

A, C, J, M, & H Cylinders

Rod Dia.	Part #	List Price
5/8"	MLR-051-WP001-063	\$ 4.34
1"	MLR-051-WP001-100	5.14
1-3/8"	MLR-051-WP001-138	6.49
1-3/4"	MLR-051-WP001-175	7.89
2"	MLR-051-WP001-200	9.00
2-1/2"	MLR-051-WP001-250	15.66
3"	MLR-051-WP001-300	17.48
3-1/2"	MLR-051-WP001-350	19.75
4"	MLR-051-WP001-400	22.43
4-1/2"	MLR-051-WP001-450	29.36
5"	MLR-051-WP001-500	31.63
5-1/2"	MLR-051-WP001-550	32.17

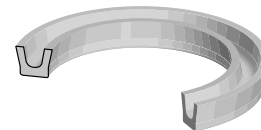

MILLER

Iron Gland

Star Bushing Style A, J, & H Cylinders

Retainer Held

Bolted

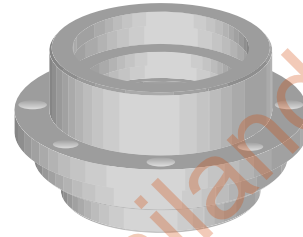
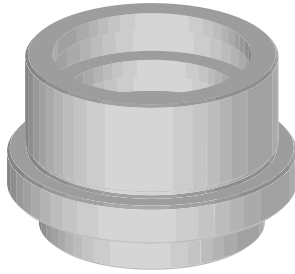

Rod Dia.	Part #	List Price	Part #	List Price
5/8"	MLR-050-BU100-063	\$ 43.82	MLR-050-BU101-063	\$ 95.21
1"	MLR-050-BU100-100	48.05	MLR-050-BU101-100	115.53
1-3/8"	MLR-050-BU100-138	62.08	MLR-050-BU101-138	137.13
1-3/4"	—		MLR-050-BU101-175	122.08
2"	—		MLR-050-BU101-200	170.45
2-1/2"	—		MLR-050-BU101-250	238.74
3"	—		MLR-050-BU101-300	265.08
3-1/2"	—		MLR-050-BU101-350	313.08
4"	—		MLR-050-BU101-400	458.87
4-1/2"	—		MLR-050-BU101-450	496.53
5"	—		MLR-050-BU101-500	564.20
5-1/2"	—		MLR-050-BU101-550	618.29

Bolted bushings from: 5/8" to 1-3/4" have 4 bolt holes
 2" to 4-1/2" have 8 bolt holes
 5" to 5-1/2" have 12 bolt holes

MILLER

Iron Gland

MILLER

A, C, J, M, & H Cylinders

Retainer Held



Bolted



Rod Dia.	Part #	List Price	Part #	List Price
5/8"	MLR-050-BU022-063	\$ 39.27	MLR-050-BU024-063	\$ 86.20
1"	MLR-050-BU022-100	49.23	MLR-050-BU024-100	103.84
1-3/8"	MLR-050-BU022-138	59.74	MLR-050-BU024-138	133.62
1-3/4"	MLR-050-BU022-175	85.55	MLR-050-BU024-175	135.14
2"	MLR-050-BU022-200	106.51	MLR-050-BU024-200	151.68
2-1/2"	MLR-050-BU022-250	132.48	MLR-050-BU024-250	175.06
3"	MLR-050-BU022-300	172.82	MLR-050-BU024-300	207.68

Bolted bushings from: 5/8" to 1-3/4" have 4 bolt holes
 2" to 4-1/2" have 8 bolt holes
 5" to 5-1/2" have 12 bolt holes

MILLER

Retainer

A, C, J, M, & H Cylinders

Rod Dia.	Part #	List Price
5/8"	MLR-050-RT005-063	\$ 26.40
1"	MLR-050-RT005-100	29.44
1-3/8"	MLR-050-RT005-138	37.60



Caged Assembly Components

Rod Seal Cage

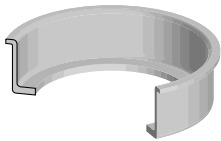

Wave Spring



Bronze Pressure Ring

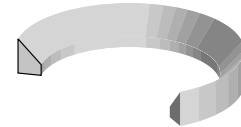

Rod Dia.	Part #	List Price	Part #	List Price	Part #	List Price
5/8"	MLR-051-CG001-063	\$ 12.87	MLR-051-WS004-063	\$ 11.19	MLR-051-PG001-063	\$ 15.30
1"	MLR-051-CG001-100	15.26	MLR-051-WS004-100	11.19	MLR-051-PG001-100	19.12
1-3/8"	MLR-051-CG001-138	17.09	MLR-051-WS004-138	11.19	MLR-051-PG001-138	28.40
1-3/4"	MLR-051-CG001-175	18.05	MLR-051-WS004-175	11.19	MLR-051-PG001-175	38.56
2"	MLR-051-CG001-200	19.79	MLR-051-WS003-200	13.62	MLR-051-PG001-200	45.08
2-1/2"	MLR-051-CG001-250	22.39	MLR-051-WS003-250	14.33	MLR-051-PG001-250	56.20
3"	MLR-051-CG001-300	31.23	MLR-051-WS003-300	17.17	MLR-051-PG001-300	78.71

MILLER

Piston Kits

A Series Cylinders

January '82 to Current

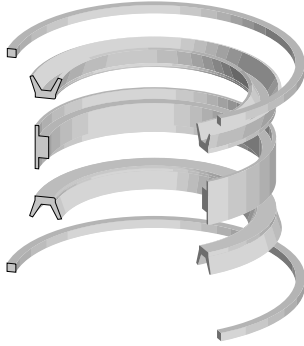
**Kit Includes:**

2 NBR U-seals
1 Wear Ring
2 PTFE Tube End Seals
(wear ring material and profile varies with size)

J Series Cylinders

January '81 to Current

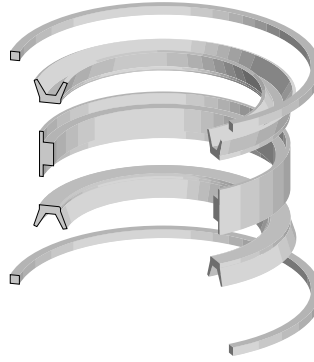
**Kit Includes:**

2 U-seals (1-PTFE up to 5",
1- NBR from 6" to 12")
1 Wear Ring
2 PTFE Tube End Seals
(wear ring and u-seal material and profile varies with size)

H Series Cylinders

January '82 to Current

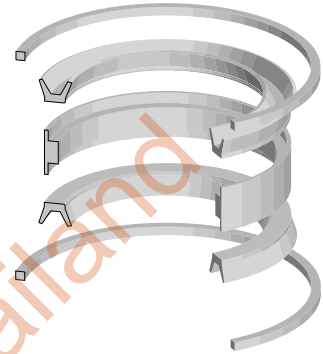
**Kit Includes:**

2 PTFE U-seals
1 T-Shape Wear Ring
2 PTFE Tube End Seals
(wear ring material varies with size)

Bore Dia.	Kit #	List Price	Kit #	List Price	Kit #	List Price
1-1/2"	MLR-090-KB001-150	\$ 49.06	MLR-091-KB001-150	\$ 56.47	MLR-171-KB001-150	\$ 77.38
2"	MLR-090-KB001-200	62.86	MLR-091-KB001-200	56.79	MLR-171-KB001-200	89.64
2-1/2"	MLR-090-KB001-250	68.19	MLR-091-KB001-250	66.13	MLR-171-KB001-250	107.75
3-1/4"	MLR-090-KB001-325	77.28	MLR-091-KB001-325	86.75	MLR-171-KB001-325	128.13
4"	MLR-090-KB001-400	89.39	MLR-091-KB001-400	95.44	MLR-171-KB001-400	176.91
5"	MLR-090-KB001-500	94.99	MLR-091-KB001-500	134.29	MLR-171-KB001-500	205.50
6"	MLR-090-KB001-600	114.40	MLR-091-KB001-600	143.50	MLR-171-KB001-600	228.71
7"	MLR-090-KB001-700	121.13	MLR-091-KB001-700	147.85	MLR-171-KB001-700	322.32
8"	MLR-090-KB001-800	124.55	MLR-091-KB001-800	159.27	MLR-171-KB001-800	402.39
10"	MLR-090-KB001-1000	139.72	MLR-091-KB001-1000	177.68	MLR-171-KB001-1000	471.51
12"	MLR-090-KB001-1200	160.10	MLR-091-KB001-1200	223.63	MLR-171-KB001-1200	533.71

MILLER

Piston Kits

HV Series Cylinders
Urethane

Bore Dia.	(URE) Kit #	List Price
1-1/2"	MLR-181-KB001-150	\$ 34.19
2"	MLR-181-KB001-200	35.64
2-1/2"	MLR-181-KB001-250	37.25
3-1/4"	MLR-181-KB001-325	41.26
4"	MLR-181-KB001-400	44.39
5"	MLR-181-KB001-500	52.55
6"	MLR-181-KB001-600	60.82
7"	MLR-181-KB001-700	61.60
8"	MLR-181-KB001-800	87.85

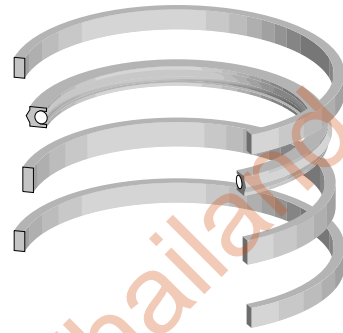
**Kit Includes:**

- 1 URE Piston Seal
- 1 Wear Ring
- 2 PTFE Tube End Seals

Piston U-seals

All Current Style Cylinders

Buna-N

PTFE

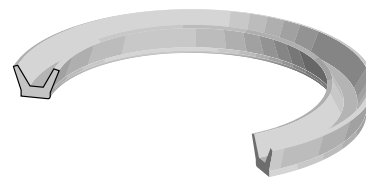
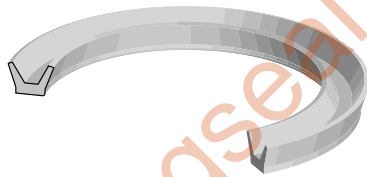

Bore Dia.	Part #	List Price	Part #	List Price
1-1/2"	MLR-052-PS025-150	\$ 6.93	MLR-052-PS017-150	\$ 9.88
2"	MLR-052-PS025-200	7.85	MLR-052-PS017-200	9.95
2-1/2"	MLR-052-PS025-250	8.36	MLR-052-PS017-250	11.74
3-1/4"	MLR-052-PS025-325	9.88	MLR-052-PS017-325	15.33
4"	MLR-052-PS025-400	13.82	MLR-052-PS017-400	20.32
5"	MLR-052-PS025-500	16.45	MLR-052-PS017-500	30.48
6"	MLR-052-PS025-600	21.07	MLR-052-PS017-600	34.85
7"	—	—	MLR-052-PS017-700	42.34
8"	—	—	MLR-052-PS017-800	49.32
10"	—	—	MLR-052-PS017-1000	77.88
12"	—	—	MLR-052-PS017-1200	104.45

MILLER

MILLER

Wear Rings

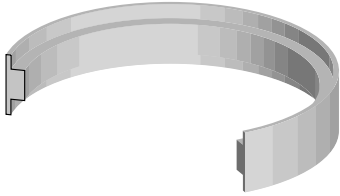
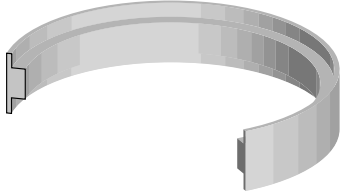
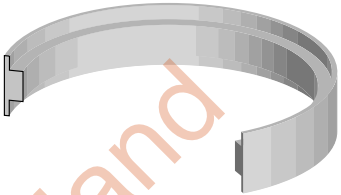
Air Service PTFE		Hydraulic Service Acetal		Hydraulic Service Bronze		
						
Bore Dia.	Part #	List Price	Part #	List Price	Part #	List Price
1-1/2"	—	—	MLR-052-WR009-150-25	\$ 15.09	—	—
2"	—	—	MLR-052-WR009-200-25	17.37	—	—
2"	—	—	MLR-052-WR009-200-31	17.64	—	—
2-1/2"	—	—	MLR-052-WR009-250-25	21.37	—	—
2-1/2"	—	—	MLR-052-WR009-250-38	22.69	—	—
3-1/4"	MLR-052-WR005-325-25	\$ 23.46	MLR-052-WR009-325-25	29.25	—	—
3-1/4"	—	—	MLR-052-WR009-325-50	32.46	—	—
4"	MLR-052-WR005-400-25	29.29	MLR-052-WR009-400-25	33.94	—	—
4"	—	—	MLR-052-WR009-400-63	45.88	—	—
5"	MLR-052-WR005-500-25	36.76	MLR-052-WR009-500-75	91.23	—	—
6"	MLR-052-WR005-600-25	43.94	MLR-052-WR009-600-75	118.16	—	—
7"	—	—	—	—	MLR-052-WR008-700-75	\$ 123.37
8"	—	—	—	—	MLR-052-WR008-800-125	165.17
10"	—	—	—	—	MLR-052-WR008-1000-125	192.71
12"	—	—	—	—	MLR-052-WR008-1200-125	210.96

PTFE Tube Seal Cord

A, C, J, M, & H Cylinders



Part #	Radial Wall	Width	List Price
MLR-008-SH001	.030	.070	\$ 55.77
Includes: 30' spool of PTFE Head Seal			
MLR-SH1-STRIP	.030	.070	4.42/ft

MILLER

Tube End Seals

Continuous PTFE

A, C, J, M, ER500, & ER3000

H & ER6000

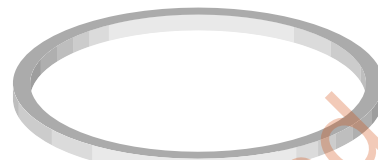
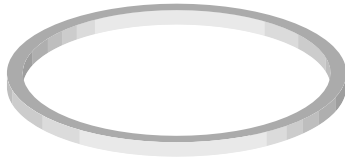

Bore Dia.	Part #	List Price	Part #	List Price
1-1/2"	MLR-090-ES009-150	\$ 5.22	MLR-170-ES010-150	\$ 8.02
2"	MLR-090-ES009-200	9.52	MLR-170-ES010-200	11.35
2-1/2"	MLR-090-ES009-250	9.56	MLR-170-ES010-250	14.72
3-1/4"	MLR-090-ES009-325	9.64	MLR-170-ES010-325	15.35
4"	MLR-090-ES009-400	14.26	MLR-170-ES010-400	18.36
5"	MLR-090-ES009-500	17.96	MLR-170-ES010-500	22.00
6"	MLR-090-ES009-600	22.37	MLR-170-ES010-600	25.46
7"	MLR-090-ES009-700	28.08	MLR-170-ES010-700	28.91
8"	MLR-090-ES009-800	34.96	MLR-170-ES010-800	36.19
10"	MLR-090-ES009-1000	41.70	MLR-170-ES010-1000	42.02
12"	MLR-090-ES009-1200	46.41	MLR-170-ES010-1200	46.82

Tube End Seals

Strip PTFE

A, C, J, M, ER500, & ER3000

H & ER6000



Bore Dia.	Part #	List Price	Part #	List Price
1-1/2"	MLR-090-ES006-150	\$ 4.22	MLR-170-ES006-150	\$ 4.14
2"	MLR-090-ES006-200	7.64	MLR-170-ES006-200	7.54
2-1/2"	MLR-090-ES006-250	7.73	MLR-170-ES006-250	7.64
3-1/4"	MLR-090-ES006-325	8.94	MLR-170-ES006-325	7.89
4"	MLR-090-ES006-400	11.08	MLR-170-ES006-400	11.24
5"	MLR-090-ES006-500	11.87	MLR-170-ES006-500	11.84
6"	MLR-090-ES006-600	14.66	—	—

MILLER

Piston Cups

A, JW, & HW Cylinders
From 1956-1977
Nitrile

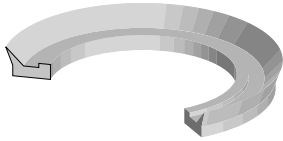

J & H Cylinders
From 1956-1977
Leather

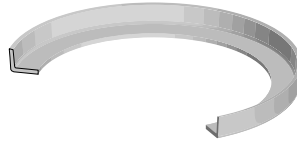

AJ, J, & H Cylinders
From 1956-1977
PTFE

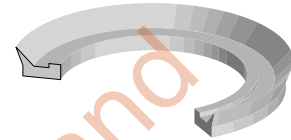

Bore Dia.	Part #	List Price	Part #	List Price	Part #	List Price
1-1/2"	MLR-052-PS001-150	\$ 7.85	MLR-052-PS003-150	\$ 12.59	MLR-052-PS006-150	\$ 11.35
2"	MLR-052-PS001-200	8.40	MLR-052-PS003-200	15.44	MLR-052-PS006-200	13.71
2-1/2"	MLR-052-PS001-250	11.48	MLR-052-PS003-250	20.68	MLR-052-PS006-250	20.39
3-1/4"	MLR-052-PS001-325	17.92	MLR-052-PS003-325	32.48	MLR-052-PS006-325	26.42
4"	MLR-052-PS001-400	20.90	MLR-052-PS003-400	39.99	MLR-052-PS006-400	32.63
5"	MLR-052-PS001-500	27.08	MLR-052-PS003-500	55.63	MLR-052-PS006-500	48.87
6"	MLR-052-PS001-600	30.79	MLR-052-PS003-600	75.41	MLR-052-PS006-600	59.06
8"	MLR-052-PS001-800	35.18	—	—	—	—
10"	MLR-052-PS001-1000	42.04	—	—	—	—

PTFE Follower Seals

J & H Cylinders
From 1956-1977

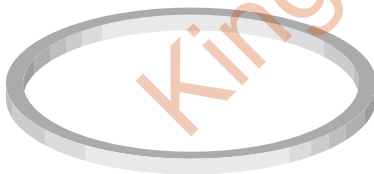

Part #	Rod Dia.	I.D.	Radial Wall	Width	List Price
MLR-052-FS001-44	5/8	7/16	.07	.07	\$ 3.98
MLR-052-FS001-75	1	3/4	.07	.07	5.42
MLR-052-FS001-100	1-3/8	1	.14	.14	8.40
MLR-052-FS001-125	1-3/4	1-1/4	.14	.14	9.33
MLR-052-FS001-150	2	1-1/2	.145	.14	11.80

Various Kits

Kit #	Rod x Bore	List Price
MLR-150-KB001-325	3-1/4	\$ 140.57
MLR-150-KB001-500	5	236.44

Kit Includes:

- 2 Leather Piston Cups
- 2 PTFE Tube End Seals
- 1 PTFE Follower Seal

PARKER

Kit Type		Page
Rod Gland Kits	A, 2A, H, 2H, VH, L, 2L, 3L, MA & 2MA Air Cylinders	50 - 53
Rod Kits	A, 2A, H, 2H, VH, L, 2L, 3L, & 2ML Cylinders	54 - 57
Gland Wrenches	For Parker Glands	57
Bronze Rod Glands	A, 2A, H, 2H, VH, L, 2L, 3L, MA, 2MA Air & Hydraulic Cylinders	58
Rod & Piston Seal Kits	MA Air Cylinders	59
Piston Kits	HL, 2HL, L, LL, 2LL, & 3LL Hydraulic Cylinders, 1A & 2A Air Cylinders, 2MA & 2ML Cylinders, L, 2L, 3L, H, 2H, HD & VH Cylinders,	60 - 65
Piston Ring Kits	H, 2H, L, 2L, & 3L Hydraulic Cylinders	66
Piston Head Seal Kits	2A, 2H, 3L, VH, 2MA & ML Cylinders	67
Various Kits		67



KINGSEAL CO., LTD. THAILAND

46/152-153 Moo 3 Sri Saman Road
Baan Mai Pakkret, Nonthaburi Thailand 11120

Tel: +662 9617534 to 6

Fax: +662 9617540

Email: intlsales@kingseal.co.th / kingsealmail@gmail.com

Website: <http://www.kingseal.co.th>

PARKER

Rod Gland Kits

A, 2A, H, 2H, VH, L, 2L, & 3L Cylinders

Nitrile

Fluorocarbon

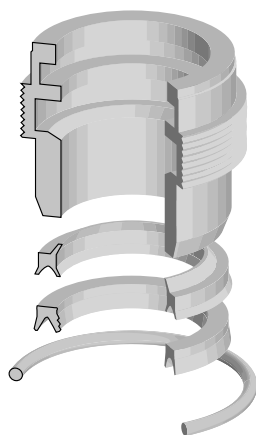
**1/2" - 3"****Kit Includes:**

- 1 Bronze Gland
- 1 XNBR Wiper
- 1 URE Back-up Ring
- 1 NBR U-seal
- 1 NBR O-ring

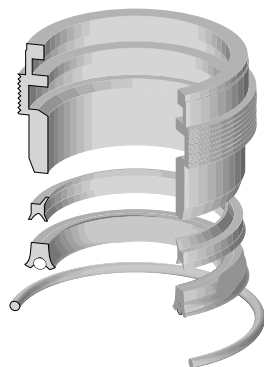
**3-1/2" - 5-1/2"****Kit Includes:**

- 1 Bronze Gland
- 1 XNBR Wiper
- 1 NBR Loaded U-seal
- 1 NBR O-ring

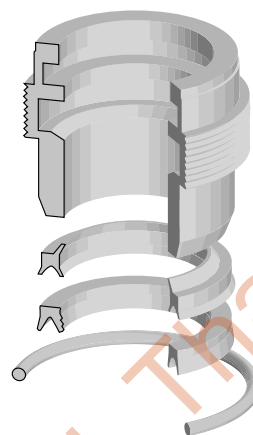
**1/2" - 3"****Kit Includes:**

- 1 Bronze Gland
- 1 FC Wiper
- 1 PTFE Back-up Ring
- 1 FC U-seal
- 1 FC O-ring

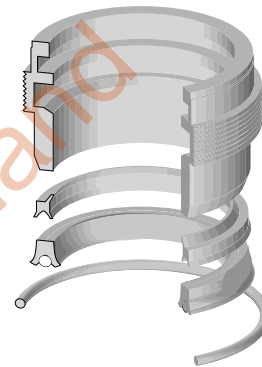
**3-1/2" - 5-1/2"****Kit Includes:**

- 1 Bronze Gland
- 1 FC Wiper
- 1 FC Loaded U-seal
- 1 FC O-ring

Rod Dia.	Kit #	List Price	Kit #	List Price
1/2"	PKH-RG2AHL0051	\$ 50.73	PKH-RG2AHL0055	\$ 63.58
5/8"	PKH-RG2AHL0061	31.02	PKH-RG2AHL0065	48.73
1"	PKH-RG2AHL0101	36.62	PKH-RG2AHL0105	55.16
1-3/8"	PKH-RG2AHL0131	44.65	PKH-RG2AHL0135	69.28
1-3/4"	PKH-RG2AHL0171	51.72	PKH-RG2AHL0175	75.66
2"	PKH-RG2AHL0201	64.51	PKH-RG2AHL0205	90.06
2-1/2"	PKH-RG2AHL0251	84.33	PKH-RG2AHL0255	112.03
3"	PKH-RG2AHL0301	97.76	PKH-RG2AHL0305	130.37
3-1/2"	PKH-RG2AHL0351	216.60	PKH-RG2AHL0355	249.03
4"	PKH-RG2AHL0401	286.31	PKH-RG2AHL0405	325.57
4-1/2"	PKH-RG2AHL0451	302.24	PKH-RG2AHL0455	341.62
5"	PKH-RG2AHL0501	335.99	PKH-RG2AHL0505	380.65
5-1/2"	PKH-RG2AHL0551	350.09	PKH-RG2AHL0555	419.44

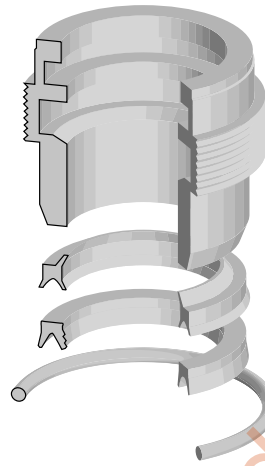
PARKER**Rod Gland Kits****2H & 3L Cylinders
Urethane****PARKER****1/2" - 5-1/2"****Kit Includes:**

- 1 Bronze Gland
- 1 XNBR Wiper
- 1 Multi-lip Urethane U-seal
- 1 NBR O-ring

Rod Dia.	Kit #	List Price
1/2"	PKH-RG2HLTS051	\$ 75.20
5/8"	PKH-RG2HLTS061	55.62
1"	PKH-RG2HLTS101	63.09
1-3/8"	PKH-RG2HLTS131	73.80
1-3/4"	PKH-RG2HLTS171	79.22
2"	PKH-RG2HLTS201	104.87
2-1/2"	PKH-RG2HLTS251	138.62
3"	PKH-RG2HLTS301	171.84
3-1/2"	PKH-RG2HLTS351	267.64
4"	PKH-RG2HLTS401	289.63
4-1/2"	PKH-RG2HLTS451	307.16
5"	PKH-RG2HLTS501	354.96
5-1/2"	PKH-RG2HLTS551	369.83

PARKER

Rod Gland Kits

MA Air Cylinders

Nitrile

Fluorocarbon

5/8" Rod Gland profile

1" & 1-3/8" Rod Gland profile

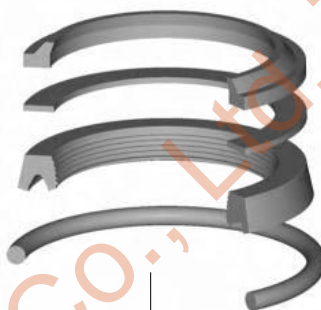
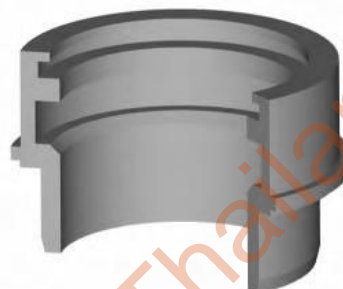

Kit Includes:

- 1 Bronze Gland
- 1 URE Wiper
- 1 PTFE Back-up Ring
- 1 NBR Multi-lip U-seal
- 1 NBR O-ring

Kit Includes:

- 1 Bronze Gland
- 1 FC Wiper
- 1 PTFE Back-up Ring
- 1 FC Multi-lip U-seal
- 1 FC O-ring

Rod Dia.	Kit #	List Price	Kit #	List Price
5/8"	PKH-RGL6948MA1	\$ 27.24	PKH-RGL6948MA5	\$ 35.78
1"	PKH-RGL6949MA1	30.05	PKH-RGL6949MA5	38.74
1-3/8"	PKH-RGL6950MA1	35.09	PKH-RGL6950MA5	49.18

PARKER

PARKER

Rod Gland Kits

2MA Air Cylinders

Nitrile



1/2" - 1-3/4"

Kit Includes:

- 1 Bronze Gland
- 1 XNBR Wiper/Seal
- 1 NBR O-ring
- 1 Tube Seal Lubricant

Fluorocarbon

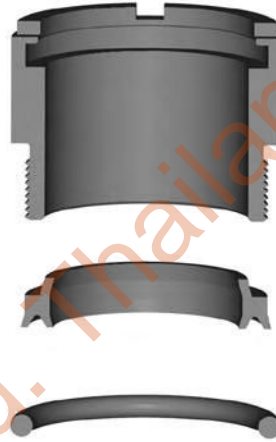

1/2" - 1-3/4"

Kit Includes:

- 1 Bronze Gland
- 1 FC Wiper/Seal
- 1 FC O-ring
- 1 Tube Seal Lubricant

Rod Dia.	Kit #	List Price	Kit #	List Price
1/2"	PKH-RG02MA0051	\$ 18.37	PKH-RG02MA0055	\$ 30.55
5/8"	PKH-RG02MA0061	19.12	PKH-RG02MA0065	32.60
1"	PKH-RG02MA0101	21.90	PKH-RG02MA0105	36.11
1-3/8"	PKH-RG02MA0131	29.98	PKH-RG02MA0135	43.81
1-3/4"	PKH-RG02MA0171	45.53	PKH-RG02MA0175	67.72

PARKER

Rod Kits

A, 2A, H, 2H, VH, L, 2L, & 3L Cylinders

Nitrile

Fluorocarbon

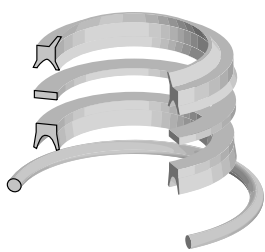
1/2" - 3"**Kit Includes:**

- 1 XNBR Wiper
- 1 URE Back-up Ring
- 1 NBR U-seal
- 1 NBR O-ring

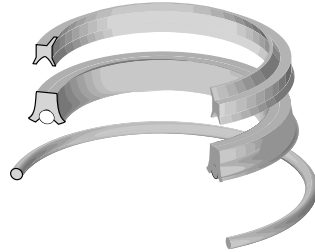
3-1/2" - 5-1/2"**Kit Includes:**

- 1 XNBR Wiper
- 1 NBR Loaded U-seal
- 1 NBR O-ring

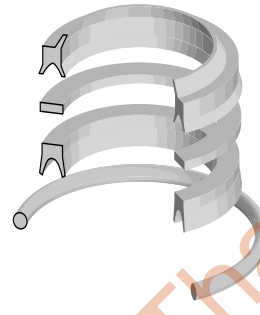
1/2" - 3"**Kit Includes:**

- 1 FC Wiper
- 1 PTFE Back-up Ring
- 1 FC U-seal
- 1 FC O-ring

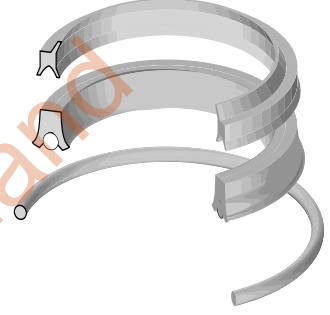
3-1/2" - 5-1/2"**Kit Includes:**

- 1 FC Wiper
- 1 FC Loaded U-seal
- 1 FC O-ring

Rod Dia.	Kit #	List Price	Kit #	List Price
1/2"	PKH-RK2AHL0051	\$ 4.69	PKH-RK2AHL0055	\$ 19.44
5/8"	PKH-RK2AHL0061	8.10	PKH-RK2AHL0065	21.36
1"	PKH-RK2AHL0101	5.85	PKH-RK2AHL0105	24.01
1-3/8"	PKH-RK2AHL0131	6.43	PKH-RK2AHL0135	31.08
1-3/4"	PKH-RK2AHL0171	7.45	PKH-RK2AHL0175	32.38
2"	PKH-RK2AHL0201	8.23	PKH-RK2AHL0205	33.75
2-1/2"	PKH-RK2AHL0251	9.23	PKH-RK2AHL0255	36.93
3"	PKH-RK2AHL0301	11.97	PKH-RK2AHL0305	44.57
3-1/2"	PKH-RK2AHL0351	56.02	PKH-RK2AHL0355	92.45
4"	PKH-RK2AHL0401	62.99	PKH-RK2AHL0405	107.13
4-1/2"	PKH-RK2AHL0451	81.60	PKH-RK2AHL0455	134.08
5"	PKH-RK2AHL0501	92.89	PKH-RK2AHL0505	156.66
5-1/2"	PKH-RK2AHL0551	113.45	PKH-RK2AHL0555	224.77

PARKER

Rod Kits

2H & 3L Cylinders Urethane

PARKER

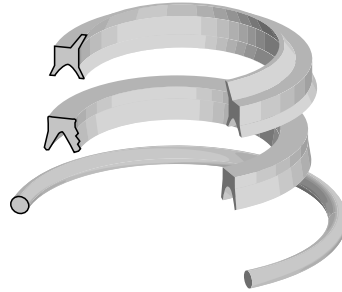

1/2" - 5-1/2"

Kit Includes:

- 1 XNBR Wiper
- 1 Multi-lip Urethane U-seal
- 1 NBR O-ring

Rod Dia.	Kit #	List Price
1/2"	PKH-RK2HLTS051	\$ 13.96
5/8"	PKH-RK2HLTS061	14.29
1"	PKH-RK2HLTS101	16.90
1-3/8"	PKH-RK2HLTS131	19.96
1-3/4"	PKH-RK2HLTS171	23.20
2"	PKH-RK2HLTS201	26.58
2-1/2"	PKH-RK2HLTS251	28.43
3"	PKH-RK2HLTS301	30.91
3-1/2"	PKH-RK2HLTS351	37.03
4"	PKH-RK2HLTS401	41.38
4-1/2"	PKH-RK2HLTS451	45.18
5"	PKH-RK2HLTS501	49.01
5-1/2"	PKH-RK2HLTS551	53.81

PARKER

Rod Kits

2MA Air Cylinders

Nitrile

Fluorocarbon



1/2" - 1-3/4"
Kit Includes:
 1 XNBR Wiper/Seal
 1 NBR O-ring
 1 Tube Seal Lubricant

1/2" - 1-3/4"
Kit Includes:
 1 FC Wiper/Seal
 1 FC O-ring
 1 Tube Seal Lubricant

Rod Dia.	Kit #	List Price	Kit #	List Price
1/2"	PKH-RK02MA0051	\$ 8.17	PKH-RK02MA0055	\$ 12.21
5/8"	PKH-RK02MA0061	8.42	PKH-RK02MA0065	12.53
1"	PKH-RK02MA0101	8.63	PKH-RK02MA0105	12.94
1-3/8"	PKH-RK02MA0131	9.23	PKH-RK02MA0135	16.22
1-3/4"	PKH-RK02MA0171	9.86	PKH-RK02MA0175	20.39

PARKER

Rod Kits

2MA Hydraulic Cylinders Urethane



1/2" - 5-1/2"

Kit Includes:

- 1 XNBR Wiper / Seal
- 1 Multi-lip Urethane U-seal
- 1 NBR O-ring

Rod Dia.	Kit #	List Price
5/8"	PKH-RK02ML0061	\$ 10.81
1"	PKH-RK02ML0101	11.16
1-3/8"	PKH-RK02ML0131	12.67
1-3/4"	PKH-RK02ML0171	14.47

Gland Wrenches

Parker Gland Wrenches

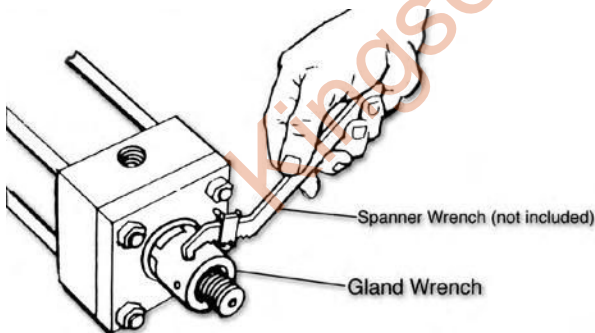

Rod Dia.	Kit #	ID X OD X HT	List Price
1/2, 5/8"	PKH-069590	11/16" X 1-1/8" X 1-3/8"	\$ 73.50
1"	PKH-069591	1-1/16" X 1-5/8" X 1-1/2"	74.72
1-3/8"	PKH-069592	1-7/16" X 1-7/8" X 1-5/8"	77.17
1-3/4"	PKH-069593	1-13/16" X 2-1/4" X 1-5/8"	78.39
2"	PKH-069594	2-1/16" X 2-1/2" X 2"	88.19
2-1/2"	PKH-069595	2-9/16" X 3" X 2-1/8"	84.51

PARKER

Bronze Rod Glands

A, 2A, H, 2H, VH, L, 2L, & 3L Air and Hydraulic Cylinders

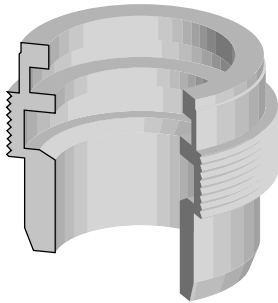

Rod Dia.	Part #	List Price
1/2"	PKH-RG-05	\$ 47.06
5/8"	PKH-RG-06	25.16
1"	PKH-RG-10	31.15
1-3/8"	PKH-RG-13	38.21
1-3/4"	PKH-RG-17	44.33
2"	PKH-RG-20	56.31
2-1/2"	PKH-RG-25	75.09
3"	PKH-RG-30	85.79
3-1/2"	PKH-RG-35	191.31
4"	PKH-RG-40	230.37
4-1/2"	PKH-RG-45	241.04
5"	PKH-RG-50	270.96
5-1/2"	PKH-RG-55	278.96

MA Air Cylinders

5/8" Rod Gland profile

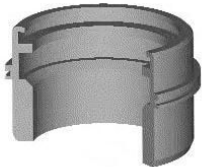

1" & 1-3/8" Rod Gland profile

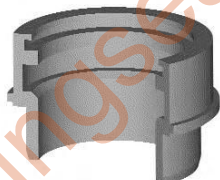

Rod Dia.	Part #	List Price
5/8"	PKH-RGMA-06	\$ 19.45
1"	PKH-RGMA-10	23.06
1-3/8"	PKH-RGMA-13	26.02

2MA Air Cylinders



Rod Dia.	Part #	List Price
1/2"	PKH-RG02MA-05	\$ 25.27
5/8"	PKH-RG02MA-06	26.29
1"	PKH-RG02MA-10	33.01
1-3/8"	PKH-RG02MA-13	40.65
1-3/4"	PKH-RG02MA-17	49.29

PARKER

PARKER

Rod & Piston Seal Kits

MA Air Cylinders

Nitrile



Kit Includes:

- 1 URE Wiper
- 1 PTFE Back-up Ring
- 1 NBR Multi-lip U-seal
- 2 NBR U-seals
- 2 URE Back-up Rings
- 3 NBR O-rings

Fluorocarbon

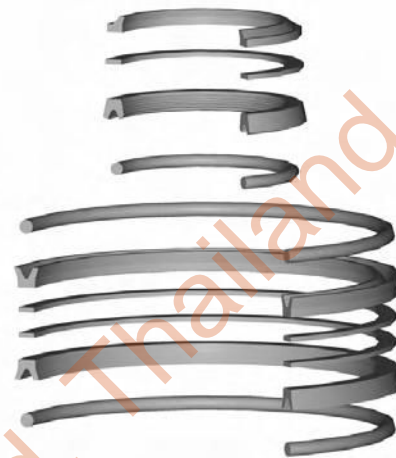

Kit Includes:

- 1 FC Wiper
- 1 FC Multi-lip U-seal
- 2 FC U-seals
- 3 PTFE Back-up Ring
- 3 FC O-rings

Rod Dia.	Bore Dia.	(NBR) Kit #	List Price	(FC) Kit #	List Price
5/8"	1-1/2"	PKH-SKL7000MA1	\$ 13.29	PKH-SKL7000MA5	\$ 37.38
5/8"	2"	PKH-SKL7001MA1	13.40	PKH-SKL7001MA5	39.10
1"	2"	PKH-SKL7002MA1	13.62	PKH-SKL7002MA5	40.83
5/8"	2-1/2"	PKH-SKL7003MA1	17.67	PKH-SKL7003MA5	47.80
1"	2-1/2"	PKH-SKL7004MA1	14.72	PKH-SKL7004MA5	49.52
1"	3-1/4"	PKH-SKL7005MA1	15.29	PKH-SKL7005MA5	52.40
1-3/8"	3-1/4"	PKH-SKL7006MA1	17.33	PKH-SKL7006MA5	59.78
1"	4"	PKH-SKL7007MA1	17.67	PKH-SKL7007MA5	62.14
1-3/8"	4"	PKH-SKL7008MA1	19.06	PKH-SKL7008MA5	69.57
1"	5"	PKH-SKL7009MA1	21.83	PKH-SKL7009MA5	75.75
1-3/8"	5"	PKH-SKL7010MA1	23.87	PKH-SKL7010MA5	83.18
1-3/8"	6"	PKH-SKL7098MA1	25.71	PKH-SKL7098MA5	102.65

PARKER

Piston Kits

HL, 2HL, L, LL, 2LL, & 3LL Hydraulic Cylinders

Nitrile

Fluorocarbon

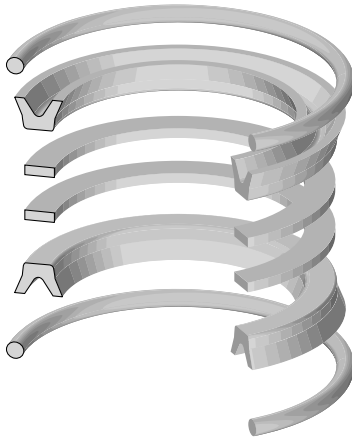
**Kit Includes:**

2 NBR U-seals
2 NBR O-ring Head Seals
2 URE Back-up Rings

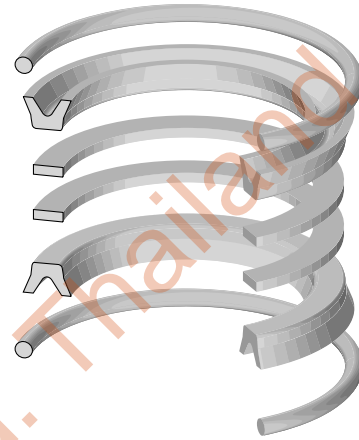
**Kit Includes:**

2 FC U-seals
2 FC O-ring Head Seals
2 PTFE Back-up Rings

Bore Dia.	(NBR) Kit #	List Price	(FC) Kit #	List Price
1"	PKH-PK102HLL01	\$ 5.80	PKH-PK102HLL05	\$ 29.87
1-1/2"	PKH-PK152HLL01	6.75	PKH-PK152HLL05	31.02
2"	PKH-PK202HLL01	8.02	PKH-PK202HLL05	48.35
2-1/2"	PKH-PK252HLL01	9.31	PKH-PK252HLL05	48.98
3-1/4"	PKH-PK322HLL01	11.53	PKH-PK322HLL05	52.80
4"	PKH-PK402HLL01	15.16	PKH-PK402HLL05	65.92
5"	PKH-PK502HLL01	17.64	PKH-PK502HLL05	78.78
6"	PKH-PK602HLL01	22.93	PKH-PK602HLL05	105.33
7"	PKH-PK702HLL01	60.93	PKH-PK702HLL05	166.99
8"	PKH-PK802HLL01	66.74	PKH-PK802HLL05	228.45
10"	PKH-PK902HLL01	119.01	PKH-PK902HLL05	357.02
12"	PKH-PK922HLL01	167.13	PKH-PK922HLL05	445.43

PARKER

Piston Kits

1A & 2A Air Cylinders

Nitrile

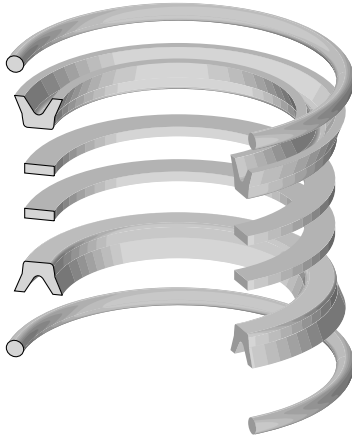

Kit Includes:

- 2 NBR O-ring Head Seals
- 2 NBR U-seals
- 2 URE Back-up Rings

Fluorocarbon

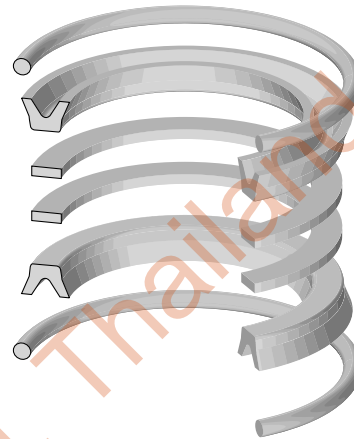

Kit Includes:

- 2 FC O-ring Head Seals
- 2 FC U-seals
- 2 PTFE Back-up Rings

Bore Dia.	(NBR) Kit #	List Price	(FC) Kit #	List Price
1"	PKH-PK1002A001	\$ 5.80	PKH-PK1002A005	\$ 22.01
1-1/2"	PKH-PK1502A001	6.82	PKH-PK1502A005	31.02
2"	PKH-PK2002A001	8.02	PKH-PK2002A005	35.40
2-1/2"	PKH-PK2502A001	9.31	PKH-PK2502A005	49.68
3-1/4"	PKH-PK3202A001	11.53	PKH-PK3202A005	57.96
4"	PKH-PK4002A001	15.16	PKH-PK4002A005	62.49
5"	PKH-PK5002A001	17.70	PKH-PK5002A005	79.30
6"	PKH-PK6002A001	22.99	PKH-PK6002A005	105.41
7"	PKH-PK7002A001	57.32	PKH-PK7002A005	167.06
8"	PKH-PK8002A001	66.74	PKH-PK8002A005	228.45
10"	PKH-PK9002A001	98.85	PKH-PK9002A005	289.97
12"	PKH-PK9202A001	134.29	PKH-PK9202A005	445.43
14"	PKH-PK9402A001	207.72	PKH-PK9402A005	727.75

PARKER

Piston Kits

2MA Cylinders

Nitrile

**Kit Includes:**

- 2 NBR O-ring Head Seals
- 2 NBR U-seals
- 2 URE Back-up Rings
- 1 Nylon Wear Ring
- 1 Tube Seal Lubricant

Fluorocarbon

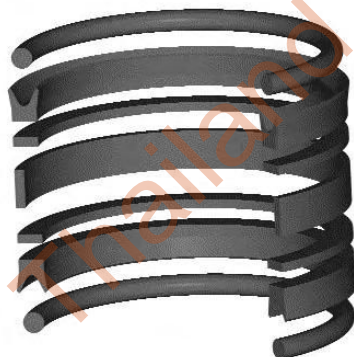
**Kit Includes:**

- 2 FC O-ring Head Seals
- 2 FC U-seals
- 2 PTFE Back-up Rings
- 1 Nylon Wear Ring
- 1 Tube Seal Lubricant

Bore Dia.	(NBR) Kit #	List Price	(FC) Kit #	List Price
1-1/2"	PKH-PK1502MA01	\$ 15.22	PKH-PK1502MA05	\$ 29.66
2"	PKH-PK2002MA01	15.43	PKH-PK2002MA05	31.75
2-1/2"	PKH-PK2502MA01	16.54	PKH-PK2502MA05	42.15
3-1/4"	PKH-PK3202MA01	19.88	PKH-PK3202MA05	52.10
4"	PKH-PK4002MA01	24.38	PKH-PK4002MA05	59.02
5"	PKH-PK5002MA01	31.55	PKH-PK5002MA05	89.32
6"	PKH-PK6002MA01	42.18	PKH-PK6002MA05	126.51
8"	PKH-PK8002MA01	74.47	PKH-PK8002MA05	211.55

PARKER

Piston Kits

2ML Cylinders Nitrile

PARKER



Kit Includes:

- 2 NBR O-ring Head Seals
- 2 NBR U-seals
- 2 URE Back-up Rings
- 1 Nylon Wear Ring

Rod Dia.	Kit #	List Price
1-1/2"	PKH-PK1502ML01	\$ 18.43
2"	PKH-PK2002ML01	13.95
2-1/2"	PKH-PK2502ML01	14.61
3-1/4"	PKH-PK3202ML01	17.39
4"	PKH-PK4002ML01	24.94
5"	PKH-PK5002ML01	41.36
6"	PKH-PK6002ML01	52.90
8"	PKH-PK8002ML01	90.15

PARKER

Piston Kits

Poly Pack kits for L, 2L, 3L, H, 2H, HD, & VH Cylinders

Urethane

Fluorocarbon

**Kit Includes:**

2 NBR O-ring Head Seals
2 NBR Loaded Urethane U-seals
2 PTFE Head Seals (1" Bore Only)

**Kit Includes:**

2 FC O-ring Head Seals
2 FC Loaded U-seals

Bore Dia.	(NBR) Kit #	List Price	(FC) Kit #	List Price
1"	PKH-PK102HLLP1	\$ 17.47	—	
1-1/2"	PKH-PK152HLLP1	12.05	PKH-PK152HLLP5	\$ 45.02
2"	PKH-PK202HLLP1	13.63	PKH-PK202HLLP5	51.05
2-1/2"	PKH-PK252HLLP1	14.31	PKH-PK252HLLP5	53.98
3-1/4"	PKH-PK322HLLP1	19.18	PKH-PK322HLLP5	99.60
4"	PKH-PK402HLLP1	22.28	PKH-PK402HLLP5	116.79
5"	PKH-PK502HLLP1	36.44	PKH-PK502HLLP5	138.86
6" *	PKH-PK602HLLP1	54.81	PKH-PK602HLLP5	279.91
6" **	PKH-PK602HLLP1-OLD	50.83	PKH-PK602HLLP5-OLD	198.79
8"	PKH-PK802HLLP1	66.88	PKH-PK802HLLP5	261.24

Note: These kits are used in the lipseal type piston for the models shown above.

* These 6" kits are for the current standard piston, Jan. 1992-current. U-seal cross section of .28".

** These 6" kits are for the pre-1992 reworked piston. U-seal cross section of 5/16".

PARKER

Piston Kits

High Load Kits for 2H, VH & HD

Nitrile

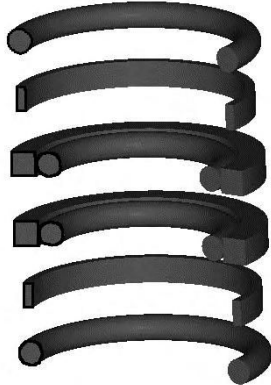

Kit Includes:

2 NBR O-ring Head Seals
 2 Nylon Wear Rings
 2 Bronze filled PTFE Piston Rings
 w/ 2 NBR Expanders

Fluorocarbon

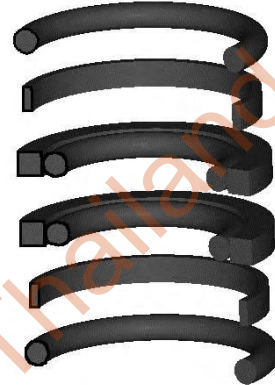

Kit Includes:

2 FC O-ring Head Seals
 2 Nylon Wear Rings
 2 Bronze filled PTFE Piston Rings
 w/ 2 FC Expanders

Bore Dia.	Kit #	List Price	Kit #	List Price
1-1/2"	PKH-PK152HK001	\$15.42	PKH-PK152HK005	\$ 21.36
2"	PKH-PK202HK001	20.01	PKH-PK202HK005	30.27
2-1/2"	PKH-PK252HK001	19.30	PKH-PK252HK005	32.55
3-1/4"	PKH-PK322HK001	25.48	PKH-PK322HK005	71.68
4"	PKH-PK402HK001	22.18	PKH-PK402HK005	79.32
5"	PKH-PK502HK001	24.90	PKH-PK502HK005	87.77
6"	PKH-PK602HK001	45.69	PKH-PK602HK005	136.85
7"	PKH-PK702HK001	100.66	PKH-PK702HK005	202.97
8"	PKH-PK802HK001	107.82	PKH-PK802HK005	296.87
10"	PKH-PK902HK001	201.99	PKH-PK902HK005	414.46
12"	PKH-PK922HK001	413.39	PKH-PK922HK005	710.17

PARKER

Piston Ring Kits

H, 2H, L, 2L, & 3L Hydraulic Cylinders

Nitrile

Fluorocarbon

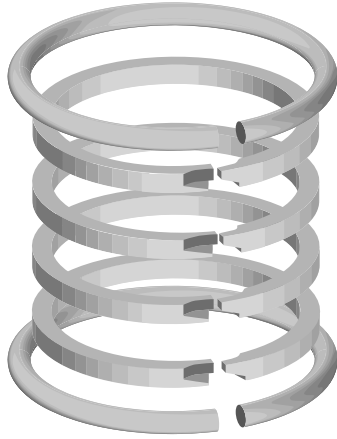
**Kit Includes:**

2 NBR O-ring Head Seals
 4 Cast Iron Piston Rings
 2 PTFE Head Seals (1" Bore Only)

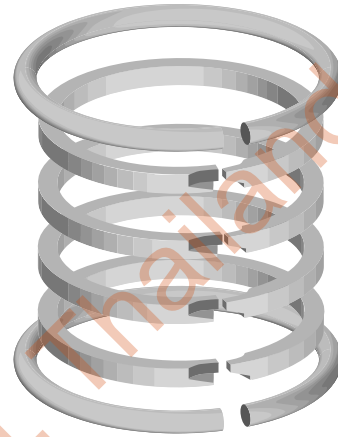
**Kit Includes:**

2 FC O-ring Head Seals
 4 Cast Iron Piston Rings
 2 PTFE Head Seals (1" Bore Only)

Bore Dia.	(NBR) Kit #	List Price	(FC) Kit #	List Price
1"	PKH-PR102H0001	\$ 50.54	PKH-PR102H0005	\$ 50.84
1-1/2"	PKH-PR152H0001	28.27	PKH-PR152H0005	32.74
2"	PKH-PR202H0001	30.16	PKH-PR202H0005	33.93
2-1/2"	PKH-PR252H0001	30.50	PKH-PR252H0005	34.40
3-1/4"	PKH-PR322H0001	32.97	PKH-PR322H0005	40.99
4"	PKH-PR402H0001	33.94	PKH-PR402H0005	41.77
5"	PKH-PR502H0001	44.70	PKH-PR502H0005	59.23
6"	PKH-PR602H0001	67.21	PKH-PR602H0005	71.68
7"	PKH-PR702H0001	75.11	PKH-PR702H0005	88.25
8"	PKH-PR802H0001	114.78	PKH-PR802H0005	122.44
10"	PKH-PR902H0001	313.59	PKH-PR902H0005	350.72
12"	PKH-PR922H0001	502.23	PKH-PR922H0005	586.18

PARKER

Piston Head Seal Kits

Nitrile

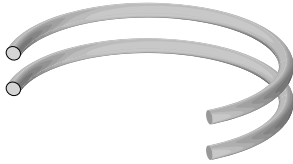

Kit Includes:
2 NBR O-ring Head Seals

Fluorocarbon

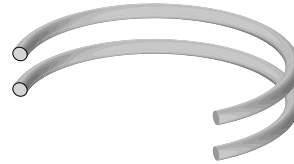

Kit Includes:
2 FC O-ring Head Seals

2A, 2H, 3L, & VH Cylinders

Bore Dia.	(NBR) Kit #	List Price	(FC) Kit #	List Price
1"	PKH-CB102HL001	\$ 4.12	PKH-CB102HL005	\$ 5.79
1-1/2"	PKH-CB152HL001	4.23	PKH-CB152HL005	6.68
2"	PKH-CB202HL001	4.45	PKH-CB202HL005	9.91
2-1/2"	PKH-CB252HL001	4.67	PKH-CB252HL005	12.47
3-1/4"	PKH-CB322HL001	4.90	PKH-CB322HL005	15.03
4"	PKH-CB402HL001	5.12	PKH-CB402HL005	18.82
5"	PKH-CB502HL001	5.90	PKH-CB502HL005	27.16
6"	PKH-CB602HL001	7.02	PKH-CB602HL005	28.39
7"	PKH-CB702HL001	7.57	PKH-CB702HL005	40.74
8"	PKH-CB802HL001	8.58	PKH-CB802HL005	41.46
9"	PKH-CB902HL001	10.46	PKH-CB902HL005	45.91

2MA & ML Cylinders

2MA Cylinders Only

Bore Dia.	(NBR) Kit #	List Price	(FC) Kit #	List Price
1-1/2"	PKH-CB1502MA01	\$ 4.03	PKH-CB1502MA05	\$ 4.20
2"	PKH-CB2002MA01	4.03	PKH-CB2002MA05	6.94
2-1/2"	PKH-CB2502MA01	4.13	PKH-CB2502MA05	6.94
3-1/4"	PKH-CB3202MA01	5.83	PKH-CB3202MA05	9.21
4"	PKH-CB4002MA01	8.90	PKH-CB4002MA05	10.11
5"	PKH-CB5002MA01	11.66	PKH-CB5002MA05	18.66
6"	PKH-CB6002MA01	15.51	PKH-CB6002MA05	30.34
8"	PKH-CB8002MA01	18.95	PKH-CB8002MA05	31.24

Various Kits

Kit #	Series	Code	Rod x Bore	List Price	
PKH-KT060VP101	VP	I-N-2	1" X 6"	\$ 15.33	Kit Includes: 1 XNBR H Style Wiper 2 NBR O-rings 1 NBR Quad Ring
PKH-KT070VP101	VP	I-N-2	1" X 7"	17.03	
PKH-KT080VP101	VP	I-N-2	1" X 8"	25.93	
PKH-KT100VP101	VP	I-N-2	1" X 10"	32.21	

NOTES

Kingseal Co., Ltd. Thailand

ROYAL

Kit Type		Page
Pneumatic Kits	A Series	70
Pneumatic Kits	M Series	71
Hydraulic Kits	H & S2 Series	72

**KINGSEAL CO., LTD. THAILAND**

46/152-153 Moo 3 Sri Saman Road
Baan Mai Pakkret, Nonthaburi Thailand 11120

Tel: +662 9617534 to 6

Fax: +662 9617540

Email: intlsales@kingseal.co.th / kingsealmail@gmail.com

Website: <http://www.kingseal.co.th>

ROYAL

A Series Pneumatic Kits

A Cylinders

Kit #	Code	Rod x Bore	List Price
RYL-KA207	N-U-5	3/4" X 2"	\$ 27.33
RYL-KA210	N-U-5	1" X 2"	27.38
RYL-KA310	I-U-5	1" X 3"	32.80
RYL-KA312	I-U-5	1-1/4" X 3"	33.16
RYL-KA412	I-U-5	1-1/4" X 4"	46.05
RYL-KA415	I-U-5	1-1/2" X 4"	46.46
RYL-KA512	I-U-5	1-1/4" X 5"	55.88
RYL-KA515	I-U-5	1-1/2" X 5"	56.30
RYL-KA615	I-U-5	1-1/2" X 6"	70.84
RYL-KA617	I-U-5	1-3/4" X 6"	71.14
RYL-KA620	I-U-5	2" X 6"	76.55
RYL-KA820	I-U-5	2" X 8"	78.44
RYL-KA1030	I-U-5	3" X 10"	86.16
RYL-KA1230	I-U-5	3" X 12"	90.22
RYL-KA1235	I-U-5	3-1/2" X 12"	92.34
RYL-KA1506	N-U-5	5/8" X 1-1/2"	5.07

Kit Composition Varies

Consult your Sales Representative.



KINGSEAL CO., LTD. THAILAND

46/152-153 Moo 3 Sri Saman Road
Baan Mai Pakkret, Nonthaburi Thailand 11120

Tel: +662 9617534 to 6

Fax: +662 9617540

Email: intlsales@kingseal.co.th / kingsealmail@gmail.com

Website: <http://www.kingseal.co.th>

ROYAL

ROYAL

M Series Pneumatic Kits

M Cylinders

Kit #	Code	Rod x Bore	List Price
RYL-KM415	N-V-7	1-1/2" X 4"	\$ 25.14
RYL-KM620	N-V-7	2" X 6"	38.46
RYL-KM820	N-V-7	2" X 8"	57.42
RYL-KM825	N-V-7	2-1/2" X 8"	58.67
RYL-KM1025	N-V-7	2-1/2" X 10"	76.38
RYL-KM1030	N-V-7	3" X 10"	81.03
RYL-KM1235	N-V-7	3-1/2" X 12"	117.31

Kit Includes:

- 1 Vee-Set
- 5 NBR O-rings
- 2 NBR Piston Cups

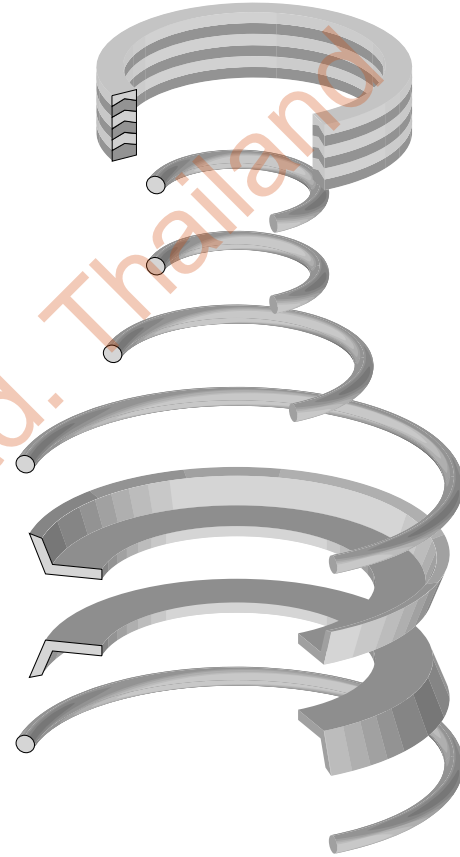

ROYAL

H Series Hydraulic Kits

H Cylinders

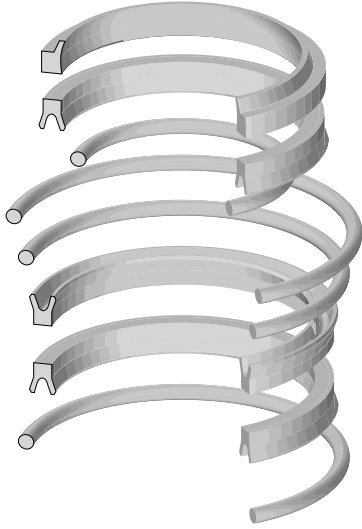

Kit #	Code	Rod x Bore	List Price
RYL-KH1510	I-U-5	1" X 1-1/2"	\$ 30.15
RYL-KH2510	I-U-5	1" X 2-1/2"	39.69
RYL-KH2517	I-U-5	1-3/4" X 2-1/2"	43.64
RYL-KH3217	I-U-5	1-3/4" X 3-1/4"	58.18
RYL-KH3220	I-U-5	2" X 3-1/4"	59.06
RYL-KH4017	I-U-5	1-3/4" X 4"	61.60
RYL-KH4025	I-U-5	2-1/2" X 4"	69.55
RYL-KH5020	I-U-5	2" X 5"	80.26
RYL-KH6025	I-U-5	2-1/2" X 6"	81.56

Kit Includes:

- 1 URE Wiper
- 3 URE U-seals
- 1 NBR O-ring
- 3 URE O-rings

S2 Series Hydraulic Kits

S2 Cylinders

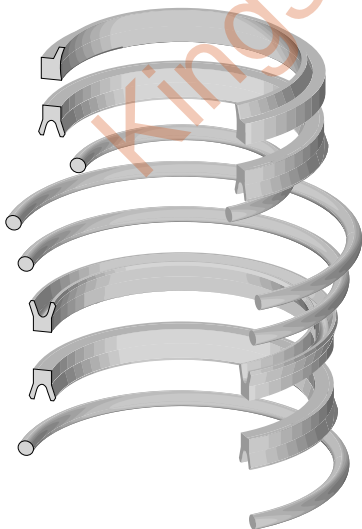

Kit #	Code	Rod x Bore	List Price
RYL-K2K212	I-U-5	1-1/4" X 2"	\$ 24.44
RYL-K2K2510	I-U-5	1" X 2-1/2"	29.80
RYL-K2K2512	I-U-5	1-1/4" X 2-1/2"	28.85
RYL-K2K312	I-U-5	1-1/4" X 3"	34.63

Kit Includes:

- 1 URE Wiper
- 3 URE U-seals
- 4 NBR O-rings

SHEFFER

Kit Type		Page
Pneumatic Kits	C20 Series	74
	A Series	75
Various Kits		75



KINGSEAL CO., LTD. THAILAND

46/152-153 Moo 3 Sri Saman Road
Baan Mai Pakkret, Nonthaburi Thailand 11120

Tel: +662 9617534 to 6

Fax: +662 9617540

Email: intlsales@kingseal.co.th / kingsealmail@gmail.com

Website: <http://www.kingseal.co.th>

SHEFFER

C20 SERIES

Pneumatic Kits

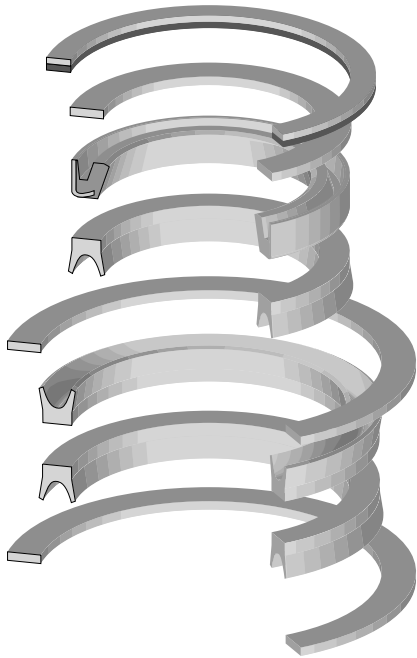

Kit #	Code	Rod x Bore	List Price
SHF-720-00150	P-U-5	1/2" X 1-1/2"	\$ 10.58
SHF-720-00200	P-U-5	1/2" X 2"	11.26
SHF-720-00250	P-U-5	5/8" X 2-1/2"	11.69
SHF-720-00300	P-U-5	3/4" X 3"	11.94
SHF-720-00350	P-U-5	3/4" X 3-1/2"	12.80
SHF-720-00400	P-U-5	1" X 4"	13.29
SHF-720-00500	P-U-5	1" X 5"	15.03
SHF-720-00600	P-U-5	1" X 6"	18.49
SHF-720-00700	P-U-5	1-3/8" X 7"	25.41
SHF-720-00800	P-U-5	1-3/8" X 8"	38.71

Kit Includes:

- 1 Metal-Clad Wiper
- 3 NBR U-seals
- 1 Steel Washer
- 2 Gaskets
- 1 Spiral Retainer Ring

(8" Bore also Includes:
 4 NBR O-rings
 2 NBR Cushion Seals)

Kingseal Co. Ltd. - Kingseal.com

SHEFFER

A SERIES

Pneumatic Kits

Kit #	Code	Rod x Bore	List Price
SHF-726-0167-0200-0062	I-U-5	5/8" X 2"	\$ 9.18
SHF-726-0167-0250-0062	I-U-5	5/8" X 2-1/2"	9.78
SHF-726-0167-0250-0100	I-U-5	1" X 2-1/2"	13.84
SHF-726-0167-0250-0137	I-U-5	1-3/8" X 2-1/2"	15.21
SHF-726-0167-0325-0100	I-U-5	1" X 3-1/4"	13.79
SHF-726-0167-0325-0137	I-U-5	1-3/8" X 3-1/4"	16.63
SHF-726-0167-0325-0175	I-U-5	1-3/4" X 3-1/4"	16.57
SHF-726-0167-0400-0100	I-U-5	1 X 4"	17.26
SHF-726-0167-0400-0137	I-U-5	1-3/8" X 4"	15.02
SHF-726-0167-0400-0175	I-U-5	1-3/4" X 4"	16.27
SHF-726-0167-0500-0100	I-U-5	1 X 5"	24.36
SHF-726-0167-0500-0137	I-U-5	1-3/8" X 5"	17.25
SHF-726-0167-0500-0175	I-U-5	1-3/4" X 5"	17.80
SHF-726-0167-0600-0137	I-U-5	1-3/8" X 6"	26.71
SHF-726-0167-0600-0175	I-U-5	1-3/4" X 6"	28.39
SHF-726-0167-0700-0137	I-U-5	1-3/8" X 7"	28.94
SHF-726-0167-0800-0137	I-U-5	1-3/8" X 8"	33.08
SHF-726-0167-0800-0175	I-U-5	1-3/4" X 8"	38.52
SHF-726-0167-1000-0175	I-U-5	1-3/4" X 10"	57.81

Kit Includes:

- 1 URE Wiper
- 5 NBR U-seals
- 4 NBR O-rings
- 2 Steel Washers
- 2 Spiral Retainer Rings

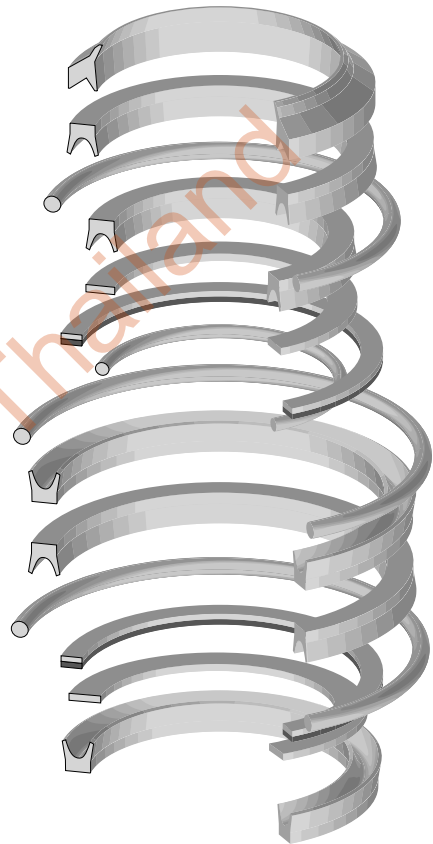

Various Kits

Kit #	Code	Rod x Bore	List Price
SHF-720-01-0600	P-U-4	1" X 6"	\$ 20.53
SHF-726-0107-0200-0100	I-U-5	1" X 2"	8.90
SHF-729-0200-K019	P-U-5	1-1/4" X 2"	19.88
SHF-729-0500-K003	P-U-5	2" X 5" Double Rod	33.59
SHF-757-01-0325-0137	I-U-10	1-3/8" X 3-1/4"	26.64
SHF-759-0100-0325-0137	I-U-5	1-3/8" X 3-1/4"	27.08
SHF-760-0100-0400-0175	I-U-10	1-3/4" X 4"	30.54
SHF-760-22-0600-0250	I-U-1	2-1/2" x 6"	66.07
SHF-761-01-0800-0350	I-U-10	3-1/2" X 8	122.20
SHF-795-S003	I-U-10	1-1/4 X 2-3/4	31.73

Kit Composition Varies

Consult your
Sales Representative.

Mobile Kits

CONTENTS		PAGE
A - B	Allis Chalmers, Anthony, Atlas, Baker, Barko, Bell, Bobcat	78 - 89
C - D	Cameco, Cascade, Caterpillar, Champion, Charlynn, Chief, Clark, Commercial, Cross, Crown, Custom Hoists, Dempster, Densmore, Drilteck, Dynahoe	90 - 218
E - F	Eaton - Yale, Edbro, Effer Crane, Energy, Esco, Euclid, Fassi-Crane, Fiat-Allis, FMC, Fontaine, Ford, Franklin, Fruehauf, Furukawa	219 - 237
G - H	Galbreath, Galion - Dresser, Garwood, Gehl, Glencoe, Gradall, Croove Crane, Harsh, Heil, Hiab, Hitachi, Husky Brute, Hyco, Hydro-Ax, Hyster, Hyundai	237 - 287
I - J	Ingersoll-Rand, International Harvester, JCB, JLG, J.I. Case, John Deere, Johnson	288 - 394
K - L	Kalmar, Kato, Kobelco, Koerhing, Komatsu, Kubota, Leach, Liebherr, Link Belt, Load Master, Log Hog, Lorain, Lucky Loader, Lull	394 - 439
M - N	Mailhot, Marion, Mark-Lift, Massey Ferguson, Meyer, Mitsubishi, Monarch Road, Morbark, New Holland, Nissan	439 - 447
O - P	Ortman, Pandrol-Jackson, Pak-Mor, Peabody Galion, Peerless, Perfection-Cobey, Pettibone, P & H Crane, Prentice, Prince	448 - 466
Q - R	Raymond, Red Lion, Reynolds, Ronen, Rotobec	467
S - T	Samsung, Skyjack, Snorkel, Steelmaster, Tamrock, Takeuchi, TMC, Terex, Tigercat, Timberjack, Tompkins-Johnson, Toyota, Trojan	468 - 479
U - V	Upright, Vanguard, Venco, Volvo	479 - 499
W - Z	Wabco, Waltco, Ward, White, Whiteman / Conspray, Yale, Yan Mar, Young Grapple, Yutani	499 - 503



KINGSEAL CO., LTD. THAILAND

46/152-153 Moo 3 Sri Saman Road
Baan Mai Pakkret, Nonthaburi Thailand 11120

Tel: +662 9617534 to 6

Fax: +662 9617540

Email: intlsales@kingseal.co.th / kingsealmail@gmail.com

Website: <http://www.kingseal.co.th>

All manufacturer's names, part numbers and descriptions are used for reference purposes only. We do not imply that any part shown is the product of these manufacturers. We also do not imply that the list price shown is exactly that of the manufacturer.

ALLIS-CHALMERS LIFT TRUCKS

Kit Number	Code (Pg. x)	Rod X Bore Size	List Price
AC-4751907	N-V-1	1-1/4 ROD KIT	\$19.82
AC-4787570	2 STAGE	1-7/8, 2-1/2	128.26
AC-4787619	9/16" SPOOL	VALVE KIT	7.07
AC-4901001	P-U-1	4-1/2 X 4-3/4	43.40
AC-4905170		3/4 SHAFT KIT	40.30
AC-4906087	I-U-4	3 X 3-1/2	41.53
AC-4906099	I-U-1	2-1/4 X 2-3/4	65.04
AC-4906100	I-U-1	2-1/4 X 2-3/4	25.26
AC-4906322	I-U-11	1-1/4 X 3	18.75
AC-4906332	I-U-11	1-1/4 X 3	20.70
AC-4906336	I-U-11	1-1/2 X 3-3/4	28.47
AC-4906380	I-U-1	1-3/4 X 2-1/4	15.72
AC-4906390	I-U-1	2-5/8 X 3-1/4	17.24
AC-4906391	I-U-4	3-3/4 X 4-1/4 W/FEEDTUBE	110.11
AC-4906392	I,P-U-1	3-3/4 X 4-1/4	48.29
AC-4906396	I-U-11	1-3/4 X 4-7/8	41.95
AC-4907400		PUMP KIT	8.59
AC-4907419	I-U-11	1-1/8 X 2-1/4	19.05
AC-4907474	P-U-1	4 X 4-1/2 W/FEEDTUBE	57.10
AC-4907475	P-U-1	3-1/2 X 4-1/4	40.15
AC-4908059	P-U-1	4-1/4 X 4-3/4	48.90
AC-4908297	I-O-3	1 X 2-1/2	10.81
AC-4908368		VALVE KIT	31.37
AC-4908540	P-U-1	5 X 5-1/2	61.49
AC-4908541	P-U-1	5 X 5-1/2 W/FEED TUBE	78.74
AC-4908555	I-O-3	3/4 X 1-1/2	5.60
AC-4908917	I-U-1	3-1/4 X 3-3/4	26.42
AC-4908980	7/8" SPOOL	VALVE KIT	8.07
AC-4909028	I-O-3	1-1/4 X 3-1/2	8.96
AC-4909035	I-O-11	1-1/2 X 2-1/2	27.35
AC-4910116	I-O-11	7/8 X 2	10.23
AC-4910977	9/16" SPOOL	VALVE KIT	5.84
AC-4911398	I-U-4	2 X 3 2 CYL'S	27.40
AC-4912036	I,P-U-1	1 X 2-1/4 X 3 MULTI-STAGE	71.23
AC-4912039	I-U-11	1-1/8 X 2-1/4	22.72
AC-4912322	I,P-U-1	1 X 1-3/4 X 2-3/8 MULTI-STAGE	71.08
AC-4912359	P-U-1	3 X 3-1/2	30.78
AC-4913028	P-U-11	7/8 X 2	26.38
AC-4913075	P-U-1	3-3/4 X 4-1/4 W/FEED TUBE	108.87
AC-4913486	P-U-1	2-1/2 X 3	35.32
AC-4914879	I-U-N	2-3/4 X 3-1/2	23.54
AC-4914917		1-7/8 X 2-5/8, 2 STAGES	65.08
AC-4917136	I-U-10	2-1/4 X 3	41.82
AC-4917655	I-U-4	1-3/4 X 2-1/4	23.39
AC-4918325	I-U-4	1 X 2	23.45
AC-4918585	I-U-1	1-1/2 X 2-1/4	18.09
AC-4932484	I-O-N	35 mm Rod Kit	9.29
AC-4942582	I-U-1	30 x 55 mm	19.90
AC-4991278	I-OB-3	1-1/8 X 2-1/4	11.26
AC-4992550	N-TR-1	7/8 Rod Only	2.83
AC-4992855	I-V-6	1-1/2 X 3-3/4	57.82
AC-4993273	I-V-6	1-1/4 X 3	25.23
AC-4993661	I-V-6	1-3/4 X 4-7/8	53.38
AC-4998712	I-N-V	3-5/8 X 4-1/4	56.31
AC-78762688	I-U-1	4-1/8 Rod Kit	45.33

ANTHONY TELESCOPIC CYLINDERS

PACKING: Vee packing - no top or bottom adaptors.
 WIPERS: Special wiper strip
 BEARINGS: Top is bronze and serves as top adaptor for vee packing and is machined on top edge o.d. to mate with retainer flange. Bottom is phenolic and serves as bottom adaptor and is machined on bottom o.d. edge to pilot over retainer ring.
 SPECIAL INFO. Unique bearing and packing retaining arrangement on each stage consisting of two external flanges which bolt together to retain top bearing. Internal stop is spiral retaining ring.
 STAGE O.D.'s: 2.475, 3.475, 4.475, 5.475, 6.475

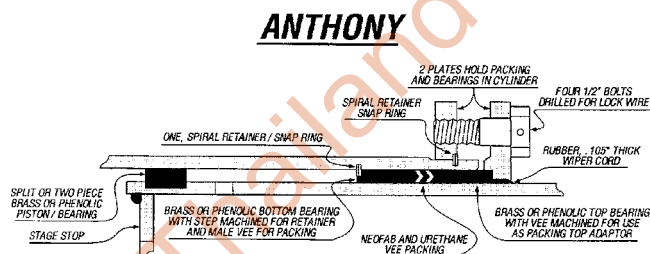

Part Number	Description	List Price
PACKING AND WIPERS		
ANY-S108002W	6-1/2" Vee Set & Wiper	\$ 36.69
ANY-S108003W	5-1/2" Vee Set & Wiper	24.72
ANY-S108004W	4-1/2" Vee Set & Wiper	21.88
ANY-S108005W	3-1/2" Vee Set & Wiper	21.37
ANY-S108006W	2-1/2" Vee Set & Wiper	19.29
BEARINGS		
ANY-S107022	6-1/2" Bottom Bearing	\$ 143.07
ANY-S107023	5-1/2" Bottom Bearing	137.80
ANY-S107024	4-1/2" Bottom Bearing	156.88
ANY-S107025	3-1/2" Bottom Bearing	72.55
ANY-S107073	5-1/2" Brass Top Bearing	166.92
ANY-S107074	4-1/2" Brass Top Bearing	150.75
ANY-S107075	3-1/2" Brass Top Bearing	83.73
ANY-S107076	2-1/2" Brass Top Bearing	36.74
INTERNAL RETAINERS		
ANY-S084005	Internal Spiral Retainer for 3" ID	\$ 4.13
ANY-S084017	Internal Spiral Retainer for 4" ID	38.16
ANY-S084018	Internal Spiral Retainer for 5" ID	38.16
ANY-S084019	Internal Spiral Retainer for 6" ID	38.63
ANY-S084020	Internal Spiral Retainer for 7" ID	48.06

ANTHONY TELESCOPIC CYLINDERS

Part Number	Description	List Price
EXTERNAL RETAINERS		
ANY-S084012	External Spiral Retainer for 3-1/2" OD	\$ 7.87
ANY-S084013	External Spiral Retainer for 4-1/2" OD	13.84
ANY-S084021	External Spiral Retainer for 6-1/2" OD	49.68
ANY-S084022	External Spiral Retainer for 5-1/2" OD	47.34
ANY-S084024	External Spiral Retainer for 7-1/2" OD	41.30
SPLIT BEARINGS		
ANY-H035098	3-1/2" Split Brass Bearing	\$ 70.62
ANY-H036212	5-1/2" Split Brass Bearing	94.04
ANY-H037062	2-1/2" Split Brass Bearing	52.02
ANY-H038099	6-1/2" Split Brass Bearing	84.61
ANTHONY REPLACEMENT CYLINDER KIT		
CH-57	Custom #73-81-114, 129, 149	\$ 59.83

ANTHONY PUMP PARTS

Part Number	Description	List Price
ANY-A143006	Wear Plate	\$ 51.04
ANY-A143031	Bearing	23.04
ANY-A143091	Packing & Nut	78.51
ANY-A91412D	Gasket - .001" Thick	1.83

ATLAS TELESCOPIC CYLINDERS

Kit Number	Description	List Price
ATL-15-517	6-1/2" Piston Bearing	\$ 3.95
ATL-15-572	4-1/2" Piston Bearing	3.01
ATL-15-573	5-1/2" Piston Bearing	3.01
ATL-15-614	3-1/2" Piston Bearing	2.81
ATL-15-616	3" Packing, Bearings, Wiper	52.14
ATL-15-617	4" Packing, Bearings, Wiper	54.70
ATL-15-618	5" Packing, Bearings, Wiper	60.01
ATL-15-619	6" Packing, Bearings, Wiper	69.08
ATL-15-620	7" Packing, Bearings, Wiper	78.87
ATL-15-621	8" Packing, Bearings, Wiper	88.63

BAKER LIFT TRUCKS

Kit Number	Code (Pg. x)	Rod X Bore Size	List Price
BAK-104840	MULTI-STAGE	3-1/2, 3-3/8, 4-7/16	\$ 111.37
BAK-105147	I-V-1	4.438 ROD	89.41
BAK-105235	I-V-1	2.9 50 ROD	24.96
BAK-105652	I-V-5	1-1/4 X 4	43.78
BAK-106390	I-U-5	1-3/4 X 4-1/2	47.69
BAK-106391	I-V-11	1-3/4 X 4	22.97
BAK-106393	I-V-11	1-1/4 X 4	24.72
BAK-106399	I-V-11	1-1/4 X 3	16.75
BAK-106657	I-V-1	3.950 ROD	45.55
BAK-106663	MULTI-STAGE	2-1/4, 2-3/8, 3-1/4	39.53
BAK-109009	I-U-4	2-1/2 X 3	29.75
BAK-109010	I-V-1	2-1/2 ROD	53.24
BAK-138727	P-U-10	22 X 60 mm	54.49
BAK-3001Y10	I-V-11	1-3/4 X 4	22.84
BAK-3001Y14	MULTI-STAGE	2-3/8, 3-1/16, 4-15/16	143.82
BAK-3001Y16	I-V-11	1-1/4 X 3	29.83
BAK-3001Y17	I-V-1	3.450 ROD	49.59
BAK-3001Y20	I-V-1	3.950 ROD	30.01
BAK-3001Y22	P-OB-10	3/4 X 2	13.93
BAK-3001Y28	I-V-5	1-1/4 X 3	41.65

BAKER LIFT TRUCKS KIT APPLICATIONS - TILT CYLINDERS

Cylinder Assembly	Repair Kit	Cylinder Assembly	Repair Kit
233HR7774ZC	3001Y10	9025FP	106391
270HR7774ZC	106399	9025FT	3001Y10
9025AT	106399	A9025GK	106393
9025AX	106399	A9025GN	106393
9025BE	3001Y10	9025GN	106393
9025BF	3001Y10	9025HC	106393
9025BL	3001Y10	9025JA	106393
9025BM	106391	9025JJ	106393
9025BN	106391	9025JM	106393
9025CH	106399	9025JS	105652
9025EG	3001Y16	9025JT	105652
9025EP	3001Y16	9025JV	105652
9025EW	3001Y10	9025JW	105652
9025FB	3001Y16	9025JX	3001Y28
9025FF	106391	9025JY	3001Y28
9025FH	3001Y10	9025KA	105652
9025FN	3001Y16	A9025KA	105652

BAKER LIFT TRUCKS KIT APPLICATIONS - TILT CYLINDERS

Cylinder Assembly	Repair Kit	Cylinder Assembly	Repair Kit
9025KB	105652	103904-05	105652
9025KC	105652	104183-86	3001Y28
100072-75	3001Y28	104639-40	105652
100472-477	105652	105840-41	105652
100503-508	105652	106058-59	105652
100516-519	105652	108259-60	105652
100742-743	105652	109351-52	105652
100960-963	105652	110872-73	106390
102793-94	3001Y28	113352-53	106390
102961-62	3001Y28		

BAKER LIFT TRUCKS KIT APPLICATIONS - HOIST CYLINDERS

Cylinder Assembly	Repair Kit	Cylinder Assembly	Repair Kit
122R7774Z	3001Y14	103583	3001Y20
160R7774XC	3001Y14	103589	3001Y20
230HR7774ZC	3001Y14	103598	3001Y20
270HR7774XC	106399	103635	3001Y20
294U7774XC	106657	103662	105147
295HR7774XC	3001Y17	103775	106663
298U7774XC	3001Y14	103855	106663
9025AD	3001Y14	103894-95	106663
9025AF	3001Y14	104100	104840
9025CN	106657	104131	3001Y14
9025D	106657	104178	105147
9025EH	3001Y17	104244	3001Y14
C9025GB	104840	104278	106663
A9025GC	3001Y20	104349	3001Y20
9025GW	105235	104377	105147
9025HH	3001Y20	104431	104840
9025HX	3001Y20	104438	104840
9025JK	106393	104441	106663
100227-230	105235	104516	105147
102019-20	105235	104529	104840
102064-67	105235	104548	3001Y20
102068-72 & 79	3001Y17	104604	105147
102506-08	105235	104617	105147
102556-559	3001Y17	104705-07	3001Y20
102569-79	106663	104745	104840
102671-79	3001Y14	104794-96	3001Y20
102695-102708	104840	104878	3001Y20
102813-16	3001Y20	104998	104840
102898-900	3001Y20	105104	3001Y20
103102	105147	105163	105147

BAKER LIFT TRUCKS KIT APPLICATIONS - HOIST CYLINDERS

Cylinder Assembly	Repair Kit	Cylinder Assembly	Repair Kit
105387-89	109010	111549-562	109010
105727	106663	111843	105235
105730	3001Y14	112006	104840
105842	104840	112037	3001Y20
105845	104840	112061	109009
105855	3001Y20	112111	104840
105933	106663	112213	104840
105962	3001Y20	112419	105235
105970	3001Y20	112562-63	109009
106138	3001Y20	112600	105147
106228	3001Y20	112658	109009
106474-76	109009	112832	105235
106477	109009	112904	104840
106647	104840	112962	109009
106672	106663	113111	105147
106733	104840	113194	109009
107695-96	105147	113228	3001Y20
107794-96	109009	113251	105235
108051	104840	113388	109009
108625	109009	113434	109009
108656	109009	113638	105147
108971-974	105235	114040	109009
109631-641	109009	114141	109009
109788	3001Y20	114283	109009
109823	105147	114392	105147
109879	109010	114889	109009
110095	109009	114954	109009
110506	109010	115237	105147
110648-657	105235	115247	3001Y20
110756	3001Y20	115656	105147
110899	105235	115956	109009
110947-949	109009	116318	109009
111059-61	109009	116740	3001Y20
111124	109010	G7328-3	104840



BARKO

Kit Number	Code (Pg. x)	Rod X Bore Size	List Price
BK-65489	6" PISTON KIT		\$ 49.41
BK-65490	I-U-3	2-1/2 X 6	29.55
BK-65500K	P-OB-12	1-3/4 X 5	24.54
BK-65501	P-OB-12	2 X 5	45.88
BK-65512	P-OB-12	1-1/2 X 3-1/2	16.51
BK-65514	P-OB-10, 12	2 X 5	48.78
BK-65515	P-OB-10, 12	2-1/2 X 6	30.86
BK-65523	I-U-5	3 X 7	75.74
BK-65524	I, P-U-5	2-1/2 X 6	71.57
BK-65525	I, P-U-5	2 X 5	61.42
BK-65531	I, P-U-5	2 X 3-1/2	34.52
BK-65532	4-1/2" SWIVEL KIT		52.78
BK-65533	I-P-U-5	2 X 3-1/2	28.70
BK-65536	I-U-5	3 X 6	77.96
BK-65537	I, P-U-5	3 X 6	68.42
BK-65576	3-1/2" SWIVEL KIT		8.26
BK-65578	6" SWIVEL KIT		24.54
BK-65583	I-U-5	4 X 7	82.67
BK-65586	I-U-5	2-1/2 X 5	48.42
BK-65588	5" SWIVEL KIT		34.82
BK-55200013	O-RING KIT		4.45
BK-55200099	1-7/8" SWIVEL KIT		36.29
BK-55200277	I-U-10	2 X 3-1/2	20.84
BK-55200418	I-U-10	2 X 3-1/2	26.22
BK-55200420	I-U-10	2-1/2 X 4-1/2	44.65
BK-55200492	O-RING KIT		3.19
BK-55200499	I-U-14	2 X 4	79.51
BK-55200616	P-UB-14	2-1/2 X 6	131.67
BK-55200617	P-UB-14	3 X 7	131.72
BK-55200636	P-UB-3	3 X 7	47.05
BK-55200637	P-UB-3	2-1/2 X 6	52.12
BK-55200641	P-UB-14	3 X 6	125.53
BK-55200659	P-UB-10	3 X 6	74.76
BK-55200660	P-UB-10	3 X 7	88.91
BK-55200668	P-U-10	2 X 3-1/2	33.15
BK-55200689	P-UB-10	2-1/2 X 6	80.01
BK-55200738		MOTOR SEAL KIT	69.54
BK-55200796	P-UB-10	2-1/2 X 4-1/2	64.34
BK-55200810	P-U-10	2-1/2 X 4-1/2	44.59
BK-55600600	8" SWIVEL KIT		235.77
BK-55600673	O-RING KIT		2.29

BARKO

Kit Number	Code (Pg. x)	Rod X Bore Size	List Price
BK-55600711	N-U-10	3 X 3-1/2	\$ 32.03
BK-55600721	N-U-10	3 X 6	61.15
BK-56500242	7" SWIVEL KIT	7	197.31
BK-565002435	3 1/2" SWIVEL KIT	3-1/2	39.63
BK-56500489	N-N-7	6 PISTON KIT	49.41
BK-56500490	I-U-3	2-1/2 X 6	29.55
BK-56500500	P-OB-12	1-3/4 X 5	24.54
BK-56500501	P-OB-12	2 X 5	45.88
BK-56500512	P-OB-12	1-1/2 X 3-1/2	16.51
BK-56500514	P-OB-10,12	2 X 5	48.78
BK-56500515	P-OB-10,12	2-1/2 X 6	30.86
BK-56500523	I-U-5	3 X 7	75.74
BK-56500524	I-U-5	2-1/2 X 6	71.57
BK-56500525	I, P-U-5	2 X 5	61.42
BK-56500531	I, P-U-5	2 X 3-1/2	34.52
BK-56500532	4-1/2" SWIVEL KIT		52.78
BK-56500533	I, P-U-5	2 X 3-1/2	28.70
BK-56500536	I-U-5	3 X 6	77.96
BK-56500537	I, P-U-5	3 X 6	68.42
BK-56500541	N-N-10	6" SWIVEL KIT	79.83
BK-56500576	3-1/2" SWIVEL KIT		8.26
BK-56500578	6" SWIVEL KIT		24.54
BK-56500583	I-U-5	4 X 7	82.67
BK-56500586	I-U-5	2-1/2 X 5	48.42
BK-56500588	5" SWIVEL KIT		34.82



Replacement Kits For

BELL

Tree Harvesters						
APPLICATION	CYL #	CODE	ROD	BORE	KIT #	List \$
MODEL SUPER T,ULTRA T						
BOOM	230057	P-U-15	50 mm	100 mm	BELL-140575	54.74
GRAB	230058	P-U-15	50 mm	100 mm	BELL-140575	54.74
SAW FEED	230105	P-U-15	1-1/4	63 mm	BELL-140311	52.99
SHEARHEAD ACCUMULATOR	230093	P-U-15	1-1/4	63 mm	BELL-140311	52.99
SHEARHEAD CUT--6"	230134	P-U-10	70 mm	150 mm	BELL-140309	106.17
SHEARHEAD GRAB	230093	P-U-15	1-1/4	63 mm	BELL-140311	52.99
SKIDDING	230106	P-U-15	50 mm	100 mm	BELL-140575	54.74
TILT	230104	P-U-15	1-1/4	63 mm	BELL-140311	52.99

BELL

Kit Number	Code (Pg. x)	Rod X Bore Size	List Price
BELL-140138	P-U-13	50 X 100 mm	\$ 54.74
BELL-140309	P-U-10	70 X 150 mm	106.17
BELL-140311	P-U-13	1-1/4 X 63 mm	52.99
BELL-140575	P-U-15	50 X 100 mm	54.74



KINGSEAL CO., LTD. THAILAND

46/152-153 Moo 3 Sri Saman Road
Baan Mai Pakkret, Nonthaburi Thailand 11120

Tel: +662 9617534 to 6

Fax: +662 9617540

Email: intlsales@kingseal.co.th / kingsealmail@gmail.com

Website: <http://www.kingseal.co.th>

Replacement Kits For

BOBCAT

BOBCAT

Articulated Loaders							
APPLICATION	CYL #	SERIAL #	CODE	ROD	BORE	KIT #	List \$
MODEL 2400, 2410							
LOADER LIFT			I-U-10	1-3/4	3	BCK-6587990	21.96
LOADER TILT			1-U-10	1-1/2	2-3/4	BCK-6589796	11.35
STEERING			I-U-10	1-1/4	2-3/4	BCK-6661296	9.11
Backhoe Attachments							
APPLICATION	CYL #	SERIAL #	CODE	ROD	BORE	KIT #	List \$
MODEL 607							
BOOM			I-U-10	1-1/2	3	BCK-6587989	18.47
DIPPER			I-U-10	1-1/2	3	BCK-6587989	18.47
TILT			I-U-10	1-1/2	3	BCK-6587989	18.47
MODEL 709							
BOOM			I-U-10	1-1/2	3-1/4	BCK-6661308	13.02
STABILIZER			I-U-10	1-1/2	3-1/4	BCK-6661308	13.02
TILT			I-U-10	1-1/2	3	BCK-6587989	18.47
MODEL 811							
DIPPER			I-U-10	1-3/4	3-1/2	BCK-6596126	17.60
TILT			I-U-10	1-1/2	3	BCK-6587989	18.47
MODEL 905							
STABILIZER			I-U-10	1	2	BCK-6587790	9.48
TILT			I-U-10	1-1/2	3	BCK-6587989	18.47
MODEL 907							
BUCKET			I-U-10	1-1/2	3	BCK-6587989	18.47
DIPPER			I-U-10	1-1/2	3	BCK-6587989	18.47
STABILIZER			P-OB-3	1	2	BCK-6598343	8.36
TILT			I-U-10	1-1/2	3	BCK-6587989	18.47
MODEL 908A							
STABILIZER			P-OB-3	1	2	BCK-6598343	8.36
TILT			I-U-10	1-1/2	3	BCK-6587989	18.47
MODEL 908B							
STABILIZER			P-OB-3	1	2	BCK-6598343	8.36
TILT			I-U-10	1-1/2	3	BCK-6587989	18.47
MODEL 909							
BOOM			I-U-10	1-1/2	3-1/4	BCK-6661297	10.60
DIPPER			P-OB-3	1	2	BCK-6598343	8.36
TILT			I-U-10	1-1/2	3	BCK-6587989	18.47
MODEL 910							
TILT			I-U-10	1-1/2	3	BCK-6587989	18.47
MODEL 911							
TILT			I-U-10	1-1/2	3	BCK-6587989	18.47
MODEL 913							
DIPPER			I-U-10	1-1/2	3	BCK-6803272	15.70
STABILIZER			I-U-10	1-1/2	3-1/4	BCK-6661298	22.43
TILT			I-U-10	1-1/2	3	BCK-6587989	18.47
MODEL 914							
TILT			I-U-10	1-1/2	3	BCK-6587989	18.47
MODEL 914A							
SWING			P-UB-9	2	4	BCK-6519428	33.67
TILT			I-U-10	1-1/2	3	BCK-6587989	18.47

Replacement Kits For

BOBCAT

BOBCAT

Backhoe Attachments							
APPLICATION	CYL #	SERIAL #	CODE	ROD	BORE	KIT #	List \$
MODEL 914B							
BUCKET			I-U-10	2	3-1/2	BCK-6588059	25.63
TILT			I-U-10	1-1/2	3	BCK-6587989	18.47
Excavators							
APPLICATION	CYL #	SERIAL #	CODE	ROD	BORE	KIT #	List \$
MODEL 220							
ARM			I-U-10	1-3/4	2-3/8	BCK-6661047	13.43
BLADE			I-U-10	1-3/4	2-3/8	BCK-6661047	13.43
BOOM			I-U-10	1-3/4	2-3/8	BCK-6661047	13.43
BUCKET			I-U-10	1-3/4	2-3/8	BCK-6661047	13.43
SWING			I-U-10, 12	1-3/8	2-3/8	BCK-6661046	43.44
VALVE-3 SPOOL						BCK-6661328	11.01
VALVE-6 SPOOL						BCK-6656283	2.47
MODEL 231							
ARM			I-U-10	1-3/4	3	BCK-6587990	21.96
BLADE			I-U-10	1-3/4	3-1/2	BCK-6661052	13.60
BOOM			I-U-10	1-3/4	3-1/4	BCK-6661051	12.96
BUCKET			I-U-10	2	3-1/4	BCK-6588083	26.38
SWING			I-U-10	1-1/2	3	BCK-6661053	13.31
VALVE						BCK-6660750	2.53
MODEL X-225							
ARM	6586724	508312001-UP	1-U-10	1-1/2	2-3/4	BCK-6589796	11.35
BLADE		508312001-UP	1-U-10	1-1/2	2-3/4	BCK-6589796	11.35
	6596045	508312001-UP	1-U-10	1-1/2	2-3/4	BCK-6589786	15.60
BOOM	6586726	508312001-UP	1-U-10	1-1/2	2-3/4	BCK-6589796	11.35
BUCKET	6538977	508312001-UP	1-U-10	1-1/2	2-3/4	BCK-6589796	11.35
SWING	6536372	508312001-UP	I-U-10	1-3/4	2-3/8	BCK-6661047	13.43
MODEL X-320							
ARM	6588297	511720001-..1115	1-U-10	1-3/8	2-3/8	BCK-6803281	21.22
	6589582	511721116 - UP	1-U-10	1-1/2	2-3/8	BCK-6589807	16.45
	6803040	562313001 - UP	1-U-10	1-1/2	2-3/8	BCK-6589807	16.45
BLADE	6587000	511720001 - UP	1-U-10	1-3/8	2-3/8	BCK-6803281	21.22
	6587000	562313001 - UP	1-U-10	1-3/8	2-3/8	BCK-6803281	21.22
	6802713		1-U-10	1-3/8	2-3/8	BCK-6803281	21.22
BOOM	6587019	511720001-..1115	1-U-10	1-3/8	2-3/8	BCK-6803281	21.22
	6589360	511721116 - UP	1-U-10	1-3/8	2-3/8	BCK-6803281	21.22
	6803045	562313001 - UP	1-U-10	1-3/8	2-3/8	BCK-6803281	21.22
BUCKET	6588658	511720001-..1115	1-U-10	1-1/2	2-1/4	BCK-6589794	15.32
	6589414	511721116 - UP	1-U-10	1-1/2	2-1/4	BCK-6589794	15.32
	6803038	562313001 - UP	1-U-10	1-1/2	2-1/4	BCK-6589794	15.32
SWING	6587963	511720001 - UP	1-U-10	1-1/4	2-3/8	BCK-6589868	11.69
	6803043	562313001 - UP	1-U-10	1-1/4	3-1/4	BCK-6801183	10.19
MODEL X-325							
ARM	6586724	511820001 - UP	1-U-10	1-1/2	2-3/4	BCK-6589796	11.35
	6595678	514011001-..012999	1-U-10	1-1/2	2-3/4	BCK-6803268	19.81
BLADE	6538976	511820001 - UP	1-U-10	1-1/2	2-3/4	BCK-6589796	11.35
	6596045	514011001-..012999	1-U-10	1-1/2	2-3/4	BCK-6589786	15.60
	6596045	511820001 - UP	1-U-10	1-1/2	2-3/4	BCK-6589786	15.60
BOOM	6586726	511820001 - UP	1-U-10	1-1/2	2-3/4	BCK-6589796	11.35

Replacement Kits For

BOBCAT

BOBCAT

Excavators							
APPLICATION	CYL #	SERIAL #	CODE	ROD	BORE	KIT #	List \$
MODEL X-325							
BOOM	6803696	514011001-..012999	1-U-10	1-1/2	2-3/4	BCK-6803268	19.81
BUCKET	6538977	511820001 - UP	1-U-10	1-1/2	2-3/4	BCK-6589796	11.35
	6803693	514011001-..012999	1-U-10	1-1/2	2-3/4	BCK-6803268	19.81
LIFTING CYLINDER	6802235	514011001-..012999	1-U-10	1-1/2	2-3/4	BCK-6803268	19.81
SWING	6536372	511820001 - UP	I-U-10	1-3/4	2-3/8	BCK-6661047	13.43
	6536372	514011001-..012999	I-U-10	1-3/4	2-3/8	BCK-6661047	13.43
MODEL X-331							
ARM	6537325	512920001 - UP	1-U-10	1-3/4	3	BCK-6588079	15.94
	6589397	512920001 - UP	I-U-10	1-3/4	3	BCK-6587990	21.96
	6589397	512911001-..999	I-U-10	1-3/4	3	BCK-6587990	21.96
	6595863	512912000 - UP	I-U-10	1-3/4	3	BCK-6587990	21.96
BLADE	6537564	512920001 - UP	I-U-10	1-3/4	3-1/2	BCK-6596126	17.60
	6537564	512911001 - UP	I-U-10	1-3/4	3-1/2	BCK-6596126	17.60
	6595987	512911001-..2001	I-U-10	1-3/4	3-1/2	BCK-6596126	17.60
	6595987	512920001 - UP	I-U-10	1-3/4	3-1/2	BCK-6596126	17.60
BOOM	6597350	512913001 - UP	I-U-10	1-3/4	3-1/2	BCK-6596126	17.60
	6587571	512911001-..999	1-U-10	1-3/4	3-1/4	BCK-6587991	17.12
	6587571	512920001 - UP	1-U-10	1-3/4	3-1/4	BCK-6587991	17.12
	6587575	512920001 - UP	1-U-10	1-3/4	3-1/4	BCK-6587991	17.12
BUCKET	6596575	512912000 - UP	1-U-10	1-3/4	3-1/4	BCK-6587991	17.12
	6537289	512911001-..999	I-U-10	2	3-1/4	BCK-6588083	26.38
	6537289	512920001 - UP	I-U-10	2	3-1/4	BCK-6588083	26.38
	6595865	512912000 - UP	I-U-10	2	3-1/4	BCK-6588083	26.38
SWING	6537577	512920001 - UP	1-U-10	1-1/2	3	BCK-6589797	12.64
	6537577	512911001 - UP	1-U-10	1-1/2	3	BCK-6589797	12.64
	6589756	512920001 - UP	I-U-10	1-1/2	3	BCK-6803272	15.70
	6589756	512911001 - UP	I-U-10	1-1/2	3	BCK-6803272	15.70
Skid Steer Loaders							
APPLICATION	CYL #	SERIAL #	CODE	ROD	BORE	KIT #	List \$
MODEL 310, 313, 371							
LIFT			I-U-10	1	2	BCK-6587790	9.48
TILT			I-U-10	1	2	BCK-6587790	9.48
MODEL 440							
LIFT			I-U-10	1	2	BCK-6587790	9.48
MODEL 440B							
LIFT	6587789	505214001	I-U-10	1	2	BCK-6587790	9.48
	6592983	505214001	I-U-10	1	2	BCK-6587790	9.48
TILT	6589196	505214001	I-U-10	1-1/4	3	BCK-6803334	16.59
	6592700	505214001	I-U-10	1-1/4	3	BCK-6803334	16.59
MODEL 443							
LIFT			I-U-10	1	2	BCK-6504960	6.40
TILT			I-U-10	1-1/4	3	BCK-6661329	11.66
MODEL 444, 500							
LIFT			I-U-10	1-1/4	2	BCK-6504959	7.04
TILT			I-U-10	1	2	BCK-6504960	6.40
MODEL 450, 453							
LIFT			I-U-10	1	2	BCK-6587790	9.48

Replacement Kits For

BOBCAT

BOBCAT

Skid Steer Loaders							
APPLICATION	CYL #	SERIAL #	CODE	ROD	BORE	KIT #	List \$
MODEL 520, 530, 533, 540, 542B, 543							
LIFT			I-U-10	1-1/4	2	BCK-6504959	7.04
TILT			I-U-10	1-1/2	3	BCK-6551271	7.53
			I-U-10	1-1/2	3	BCK-6803272	15.70
MODEL 543B							
TILT			I-U-10	1-1/2	3	BCK-6803272	15.70
MODEL 553							
LIFT			I-U-10	1-1/4	2	BCK-6586298	12.72
TILT			I-U-10	1-1/2	3	BCK-6803272	15.70
MODEL 600							
LIFT	6501103	4958MA17001	I-U-10	1-1/4	2	BCK-6803329	13.65
TILT			I-U-10	1	2	BCK-6504960	6.40
	6531681	4958MA17001	I-U-10	1	2	BCK-6587790	9.48
MODEL 610, 620							
LIFT			I-U-10	1-1/4	2	BCK-6803329	13.65
TILT			I-U-10	1	2	BCK-6587790	9.48
			I-U-10	1	2	BCK-6504960	6.40
MODEL 630							
LIFT			I-U-10	1-1/4	2	BCK-6803329	13.65
TILT		UP TO 12999	I-U-10	1-1/2	3	BCK-6587989	18.47
			I-U-10	1-1/2	3-1/4	BCK-6661308	13.02
MODEL 640							
TILT			I-U-10	1-1/2	3-1/4	BCK-6661308	13.02
			I-U-10	1-1/2	3-1/4	BCK-6661297	10.60
MODEL 642							
LIFT	6586671	5014-M-11001	I-U-10	1-1/4	2	BCK-6803329	13.65
TILT w/ Replaceable Tube		5014-M-11001	I-U-10	1-1/2	3-1/4	BCK-6591885	12.36
	6539810	5014-M-11001	I-U-10	1-1/2	3-1/4	BCK-6661308	13.02
TILT w/ Welded Tube		5014-M-11001	I-U-10	1-1/2	3-1/4	BCK-6529691	12.12
MODEL 642B							
LIFT	6586671	504025001	I-U-10	1-1/4	2	BCK-6586298	12.72
TILT	6539810	504025001	I-U-10	1-1/2	3-1/4	BCK-6661308	13.02
MODEL 643							
LIFT w/ Replaceable Tube	6586671	5015-M-13001	I-U-10	1-1/4	2	BCK-6803329	13.65
TILT w/ Replaceable Tube		5015-M-13001	I-U-10	1-1/2	3-1/4	BCK-6591885	12.36
	6539810	5015-M-13001	I-U-10	1-1/2	3-1/4	BCK-6661308	13.02
TILT w/ Welded Tube		5015-M-13001	I-U-10	1-1/2	3-1/4	BCK-6661308	13.02
MODEL 653							
TILT			I-U-10	1-1/2	3-1/4	BCK-6589792	19.00
MODEL 700, 720, 721, 722							
LIFT			I-U-10	1-1/4	2	BCK-6504959	7.04
TILT			I-U-10	1	2	BCK-6504960	6.40
			I-U-10	1	2	BCK-6587790	9.48
MODEL 730, 731, 732							
LIFT			I-U-10	1-1/4	2	BCK-6803329	13.65
			I-U-10	1-1/2	3-1/4	BCK-6661308	13.02
TILT			P-U-10	1-1/2	3-1/4	BCK-6514736	13.55
			I-U-10	1-1/2	3-1/4	BCK-6661308	13.02

Replacement Kits For

BOBCAT

BOBCAT

Skid Steer Loaders							
APPLICATION	CYL #	SERIAL #	CODE	ROD	BORE	KIT #	List \$
MODEL 733							
TILT			P-U-10	1-1/2	3-1/4	BCK-6514736	13.55
MODEL 741							
LIFT			I-U-10	1-1/4	2	BCK-6586298	12.72
LIFT w/ Replaceable Tube			I-U-10	1-1/4	2	BCK-6803329	13.65
TILT			I-U-10	1-1/2	3-1/4	BCK-6661308	13.02
			P-U-10	1-1/2	3-1/4	BCK-6514736	13.55
TILT(CESSNA)			P-U-10	1-1/2	3-1/4	BCK-6514736	13.55
TILT(MELROE)		<=12999	I-U-10	1-1/2	3-1/4	BCK-6661297	10.60
MODEL 742, 743							
LIFT			I-U-10	1-1/4	2	BCK-6586298	12.72
LIFT w/ Replaceable Tube			I-U-10	1-1/4	2	BCK-6803329	13.65
TILT			P-U-10	1-1/2	3-1/4	BCK-6514736	13.55
			I-U-10	1-1/2	3-1/4	BCK-6661308	13.02
TILT(CESSNA)			P-U-10	1-1/2	3-1/4	BCK-6514736	13.55
MODEL 742B							
LIFT	6586671	18001 & ABOVE	I-U-10	1-1/4	2	BCK-6803329	13.65
TILT	6539810	18001 & ABOVE	I-U-10	1-1/2	3-1/4	BCK-6661308	13.02
MODEL 743B							
LIFT w/ Replaceable Tube	6586671		I-U-10	1-1/4	2	BCK-6803329	13.65
TILT(MELROE)	6539810		I-U-10	1-1/2	3-1/4	BCK-6661308	13.02
MODEL 743DS							
LIFT			I-U-10	1-1/4	2	BCK-6803329	13.65
TILT			I-U-10	1-1/2	3-1/4	BCK-6661297	10.60
MODEL 751							
LIFT	6586575	514711001	I-U-10	1-1/4	2	BCK-6803329	13.65
TILT	6586905	514711001	I-U-10	1-1/2	3-1/4	BCK-6589792	19.00
MODEL 753							
LIFT			I-U-10	1-1/4	2	BCK-6586298	12.72
TILT			I-U-10	1-1/2	3-1/4	BCK-6538144	15.72
			I-U-10	1-1/2	3-1/4	BCK-6589792	19.00
MODEL 763							
LIFT	6589259	512212001 & UP	I-U-10	1-1/2	2-1/4	BCK-6803325	17.01
TILT w/ Rod Eye Grease	6804630	512212001 & UP	I-U-10	1-1/2	3-1/2	BCK-6804606	19.75
MODEL 773							
LIFT	6537254	509635001	I-U-10	1-1/2	2-1/4	BCK-6803325	17.01
TILT	6539931	509635001	I-U-10	1-1/2	3-1/2	BCK-6803274	15.47
MODEL 825							
LIFT			I-U-10	1-1/2	2-1/4	BCK-6555117	7.28
			I-U-10	1-1/2	2-1/4	BCK-6589793	11.29
TILT			I-U-10	1	2-1/4	BCK-6544447	7.32
TILT w/ Replaceable Tube			I-U-10	1-1/2	3-1/4	BCK-6661297	10.60
MODEL 843							
LIFT			I-U-10	1-1/2	2-1/4	BCK-6589793	11.29
			I-U-10	1-1/2	2-1/4	BCK-6587974	11.66
TILT			I-U-10	1-1/2	3-1/4	BCK-6538144	15.72
			I-U-10	1-1/2	3-1/4	BCK-6661308	13.02
MODEL 843B							
LIFT	6529692	503760001	I-U-10	1-1/2	2-1/4	BCK-6589793	11.29

Replacement Kits For

BOBCAT

BOBCAT

Skid Steer Loaders							
APPLICATION	CYL #	SERIAL #	CODE	ROD	BORE	KIT #	List \$
MODEL 843B							
TILT	6539808	503760001	I-U-10	1-1/2	3-1/4	BCK-6661308	13.02
MODEL 853							
LIFT		512811001-15999	I-U-10	1-1/2	2-1/4	BCK-6587974	11.66
	6587125	512811001-15999	I-U-10	1-1/2	2-1/4	BCK-6586915	11.32
TILT		512811001-15999	I-U-10	1-1/2	3-1/4	BCK-6661308	13.02
	6586991	512811001-15999	I-U-10	1-1/2	3-1/4	BCK-6589792	19.00
MODEL 863							
LIFT	6800973	514411001 & UP	I-U-10	1-3/4	2-1/2	BCK-6803312	18.60
TILT		514411001 & UP	I-U-10	1-1/2	3-1/2	BCK-6803274	15.47
	6800466	514411001 & UP	I-U-10	1-5/8	3-1/2	BCK-6804615	20.06
MODEL 873							
LIFT	6589198	514111001 & UP	I-U-10	1-1/2	2-3/4	BCK-6804609	25.90
TILT - LH	6597376	514111574-15042	I-U-10	1-1/4	2-1/2	BCK-6595177	11.11
	6597387	514111001-514111573	I-U-10	1-1/4	2-1/2	BCK-6595177	11.11
	6800683	514115043 & UP	I-U-10	1-5/8	2-3/4	BCK-6804616	27.00
TILT - RH	6597377	514111574-15042	I-U-10	1-1/4	2-1/2	BCK-6595177	11.11
	6597388	514111001-514111573	I-U-10	1-1/4	2-1/2	BCK-6595177	11.11
	6800682	514115043 & UP	I-U-10	1-5/8	2-3/4	BCK-6804616	27.00
MODEL 943							
LIFT			I-U-10	1-1/2	3	BCK-6661053	13.31
			I-U-10	1-3/4	3	BCK-6587990	21.96
TILT			I-U-10	1-1/2	3	BCK-6551271	7.53
MODEL 953							
TILT			I-U-10	1-1/2	3	BCK-6803272	15.70
MODEL 970							
LIFT			I-U-10	2	3-1/2	BCK-6588059	25.63
		Prior to 110418	I-V-10	2	3-1/2	BCK-6509053	12.27
TILT			I-U-10	1-1/2	3	BCK-6803272	15.70
MODEL 974, 975							
LIFT			I-U-10	2	3-1/2	BCK-6588059	25.63
TILT			I-U-10	1-1/2	3	BCK-6803272	15.70
			I-U-10	1-1/2	3	BCK-6551271	7.53
MODEL 980							
LIFT			I-U-10	2	3-1/2	BCK-6588059	25.63
TILT			I-U-10	1-1/2	3	BCK-6587989	18.47
MODEL 1213							
LIFT			I-U-10	1-1/2	2-1/4	BCK-6589793	11.29
MODEL 1600							
LIFT			I-U-10	2	3-1/2	BCK-6588059	25.63



BOBCAT (MELROE)

Kit Number	Code (Pg. x)	Rod X Bore Size	List Price
BCK-6504945	P-O-2	1 X 1-7/8	\$ 3.19
BCK-6504959	I-U-10	1-1/4 X 2	7.04
BCK-6504960	I-U-10	1 X 2	6.40
BCK-6504961	P-O-2	1 X 2	3.23
BCK-6505849	P-V-8	1-1/8 X 2	17.03
BCK-6505850	P-V-8	1 X 2	11.76
BCK-6509052	I-U-10	1-1/2 X 3	12.90
BCK-6509053	I-V-10	2 X 3-1/2	12.27
BCK-6509122	I-U-10,12	2 X 4	30.18
BCK-6509123	I-U-10,12	2-1/2 X 4	32.76
BCK-6509124	I-U-10,12	2 X 3-1/2	20.78
BCK-6511216	I-U-10	2-1/2 X 5	20.11
BCK-6511620	# 174 ACCUMULATOR		6.63
BCK-6512049	P-U-10	1-1/4 X 2-1/2	20.11
BCK-6512891	I-U-10	1-1/2 X 3	9.89
BCK-6514736	P-U-10	1-1/2 X 3-1/4	13.55
BCK-6515452	P-OB-3	1-1/2 X 3	7.10
BCK-6515459	P-O-1	2-3/4 ROD	10.79
BCK-6518500	O-RINGS		3.12
BCK-6519428	P-UB-9	2 X 4	33.67
BCK-6529691	I-U-10	1-1/2 X 3-1/4	12.12
BCK-6538144	I-U-10	1-1/2 X 3-1/4	15.72
BCK-6544447	I-U-10	1 X 2-1/4	7.32
BCK-6544448	I-U-10	1-1/4 X 2-1/4	6.74
BCK-6548178	I-U-10	2 X 3-1/2	9.61
BCK-6551271	I-U-10	1-1/2 X 3	7.53
BCK-6555117	I-U-10	1-1/2 X 2-1/4	7.28
BCK-6555851	I-U-10	1-1/2 X 3-1/2	10.70
BCK-6557718	I-U-10	1-1/2 X 3	7.06
BCK-6557719	I-U-10	1-1/4 X 2	6.78
BCK-6558847	I-U-10	1-1/2 X 3-1/4	8.05
BCK-6573437	I-OB-3	1-1/2 X 2	1.24
BCK-6586298	I-U-10	1-1/4 X 2	12.72
BCK-6586915	I-U-10	1-1/2 X 2-1/4	11.32
BCK-6587790	I-U-10	1 X 2	9.48
BCK-6587974	I-U-10	1-1/2 X 2-1/4	11.66
BCK-6587985	I-U-10	1-1/2 X 2-1/4	20.08
BCK-6587987	I-U-10	1-1/2 X 2-3/4	9.15
BCK-6587989	I-U-10	1-1/2 X 3	18.47
BCK-6587990	I-U-10	1-3/4 X 3	21.96
BCK-6587991	I-U-10	1-3/4 X 3-1/4	17.12
BCK-6588059	I-U-10	2 X 3-1/2	25.63
BCK-6588079	I-U-10	1-3/4 X 3	15.94
BCK-6588083	I-U-10	2 X 3-1/4	26.38
BCK-6589064	I-U-10	1 X 2	22.67
BCK-6589786	I-U-10	1-1/2 X 2-3/4	15.60
BCK-6589792	I-U-10	1-1/2 X 3-1/4	19.00
BCK-6589793	I-U-10	1-1/2 X 2-1/4	11.29
BCK-6589794	I-U-10	1-1/2 X 2-1/4	15.32
BCK-6589796	I-U-10	1-1/2 X 2-3/4	11.35

Kit Number	Code (Pg. x)	Rod X Bore Size	List Price
BCK-6589797	I-U-10	1-1/2 X 3	\$ 12.64
BCK-6589798	I-U-10	1-1/2 X 3	17.76
BCK-6589807	I-U-10	1-1/2 X 2-3/8	16.45
BCK-6589868	I-U-10	1-1/4 X 2-3/8	11.69
BCK-6590898	I-U-10	2 X 3	12.68
BCK-6591031	P-U-10	2-1/2 X 5-1/2	26.80
BCK-6591885	I-U-10	1-1/2 X 3-1/4	12.36
BCK-6592010	I-U-10	1-1/2 X 3	10.18
BCK-6592276	I-U-3	1 X 2-1/4	9.61
BCK-6592780	I-U-10	1-3/4 X 3	11.32
BCK-6593287	I-U-10	2 X 3-3/4	13.80
BCK-6595177	I-U-10	1-1/4 X 2-1/2	11.11
BCK-6596126	I-U-10	1-3/4 X 3-12	17.66
BCK-6598220	O-RING KIT		3.00
BCK-6598343	P-OB-3	1 X 2	8.36
BCK-6634687	I-U-5	1-1/4 X 2-1/2	15.67
BCK-6635405	I-OB-3	1-1/8 X 2-1/2	5.17
BCK-6651242	MOTOR SEAL KIT		46.09
BCK-6656283	O-RING KIT		2.47
BCK-6660750	O-RING KIT		2.53
BCK-6661046	P-U-10,12	1-3/8 X 2-3/8	43.44
BCK-6661047	I-U-10	1-3/4 X 2-3/8	13.43
BCK-6661051	I-U-10	1-3/4 X 3-1/4	12.96
BCK-6661052	I-U-10	1-3/4 X 3-1/2	13.60
BCK-6661053	I-U-10	1-1/2 X 3	13.31
BCK-6661288	I-U-10	1 X 2	8.05
BCK-6661296	I-U-10	1-1/4 X 2-3/4	9.11
BCK-6661297	I-U-10	1-1/2 X 3-1/4	10.60
BCK-6661298	I-U-10	1-1/2 X 3-1/4	22.43
BCK-6661308	I-U-10	1-1/2 X 3-1/4	13.02
BCK-6661317	I-U-10	1-1/4 X 2-1/4	10.07
BCK-6661328	VALVE KIT		11.01
BCK-6661329	I-U-10	1-1/4 X 3	11.66
BCK-6801183	I-U-10	1-1/4 X 3-1/4	10.19
BCK-6803268	I-U-10	1-1/2 X 2-3/4	19.81
BCK-6803272	I-U-10	1-1/2 X 3	15.70
BCK-6803274	I-U-10	1-1/2 X 3-1/2	15.47
BCK-6803281	I-U-10	1-3/8 X 2-3/8	21.22
BCK-6803312	I-U-10	1-3/4 X 2-1/2	18.60
BCK-6803325	I-U-10	1-1/2 X 2-1/4	17.01
BCK-6803329	I-U-10	1-1/4 X 2-3/8	13.65
BCK-6803334	I-U-10	1-1/4 X 3-1/4	16.59
BCK-6804605	I-U-10	1-1/2 X 3-1/4	26.25
BCK-6804606	I-U-10	1-1/2 X 3-1/2	19.75
BCK-6804609	I-U-10	1-1/2 X 2-3/4	25.90
BCK-6804615	I-U-10	1-5/8 X 3-1/2	20.06
BCK-6804616	I-U-10	1-5/8 X 2-3/4	27.00
BCK-749049	I-OB-3	1-1/2 X 2	7.55
BCK-M610	P-O-2	1-1/8 X 1-7/8	2.97

CAMECO

Kit Number	Cylinder	Code (Pg. x)	Rod X Bore Size	List Price
CAM-061-0007820		P-U-3	1-1/2 X 3-1/2	\$ 10.74
CAM-061-0021481		I-U-4	2-1/2 X 5	146.22
CAM-061-05021	001-05007	P-U-5	1-1/4 X 3	52.94
CAM-061-05835		P-U-3	1-1/4 X 2-1/2	9.75
CAM-061-06067	001-06063	P-OB-3	1-1/16 X 2-1/2	7.55
CAM-061-07221		I-V-5	2-1/2 X 7	94.79
CAM-061-08458	001-08459	I-U-5	2-1/2 X 4	55.65
CAM-061-08913		I-U-5	2-1/2 X 5	49.98
CAM-061-09619		P-U-3	2 X 4	19.89
CAM-061-1309627		P-U-10	4 X 7	183.00
CAM-061-21693		I-U-9	2-1/2 X 4	49.17
CAM-061-21699	001-21359	I-U-9	1-1/4 X 3	40.00
CAM-061-50139		P-V-3	1-1/4 X 3	19.23
CAM-061-53511		P-UB-10	2-1/2 X 4	40.56
CAM-061-53967	001-37224		1-1/4 ROD KIT	22.20
CAM-061-53968		P-U-1	1-1/2 ROD KIT	18.59
CAM-061-53970	001-89599		2-1/2 ROD KIT	23.16
CAM-061-53972	001-89576		3" PISTON KIT	21.63
CAM-061-53973	001-89599		4" PISTON KIT	24.24
CAM-061-53974		N-N-10	5" BORE	110.83
CAM-062-05672			VALVE KIT	2.52
CAM-062-22730			MOTOR KIT	7.84

CASCADE

Kit Number	Code (Pg. x)	Rod X Bore Size	List Price
CAS-552715	I-U-1	2-1/4 X 2-3/4	\$ 27.66
CAS-554289	4, 5	MULTI-STAGE	94.65
CAS-560349	I-U-4	2" X 75 mm	59.75
CAS-562591	I-U-4	2" X 60 mm	47.75
CAS-615939	O-RING KIT		4.24
CAS-615940	O-RING KIT		5.60
CAS-628080	I-V-8	1-1/4 X 3	37.44
CAS-630033	I-U-3	1-1/2 X 4-3/4	19.11
CAS-630038	I-U-3	1-1/2 X 4-3/4	17.70
CAS-630445	I-V-8	1-1/4 X 2-1/2	32.86
CAS-631277	P-V-9	2 X 4-3/4	112.36
CAS-638884	4-1/4, 5-7/16	MULTI-STAGE	59.19
CAS-639695	I-U-4	3/4 X 1-3/4	29.32
CAS-640371	I-O-4	4 X 4-1/2	49.16
CAS-641956	4,5	MULTI-STAGE	80.73

CASCADE

Kit Number	Code (Pg. x)	Rod X Bore Size	List Price
CAS-643280	I-U-4	3 X 3-1/2	\$ 30.91
CAS-644690	I-U-5	1-3/4 X 4	59.13
CAS-646339	SWIVEL KIT		3.82
CAS-647626	I-U-4	1 X 2-1/4	15.56
CAS-647892	I-V-8	1-3/4 X 4.520	43.70
CAS-650018	I-U-5	3-1/2 X 7	68.65
CAS-651847	I-N-4	2 X 2-1/2	23.20
CAS-654519	P-V-1	2 X 4-3/4	29.78
CAS-656167	4-1/4, 5-7/16	MULTI-STAGE	114.11
CAS-658717	2-3/4, 3-3/4	MULTI-STAGE	55.79
CAS-660954	I-U-4	1-5/8 X 3-1/2	33.01
CAS-660955	I-U-4	3 X 4	38.92
CAS-664814	N-U-4	3/4 X 1-3/4	16.19
CAS-667622	2-1/2, 3-1/4, 4-1/2	MULTI-STAGE	109.20

45C VIEWMAST II

CAS-T555286	P-U-10	2-1/8 X 3	46.33
-------------	--------	-----------	-------



REPLACEMENT SEAL KITS FOR CATERPILLAR® EQUIPMENT*

CATERPILLAR®

Replacement Seal Kits By Machine Type

Table of Contents

Machine Type		Page
Agricultural Tractors	65, 65B, 75, 65C, 65D, 70C, 65E, 69D, 73D, 75C, 75D, 75E, 75G, 85C	92
Articulated Dump Trucks	D250B, D250D, D250E, D25C, D25D, D300B, D300B AG, D300B CANE H, D30C, D30D, D350B, D350C, D350D, D350E, D35C, D35HP, D35HPC, D400, D400D, D400E, D40D	92 - 94
Backhoe-Loaders	416, 416B, 416C, 426, 426B, 426C, 428, 428B, 428C, 436, 436B, 436C, 438, 438B, 438C, 446, 446B	94 - 105
Bulldozers	3P, 3S, 4S, 5A, 5S, 6, 6S, 7A, 7S, 7U, 7SU, 8A, 8B, 8D, 8R, 8S, 8U, 9B, 9R, 9S, 9U	105 - 106
Excavators	215, 215C, 219, 215B, 215D, 219D, 225, 225B, 225D, 227, 229, 229D, 231D, 235, 235 FS, 235B, 235C, 235C, FS, 235D, 245 FS, 245, 245B, 245B FS, 245D, 307, 307B, 308B, 311, 311B, 312, 312B, 312BL, 313B, 315, 317, 315B, 315BL, 317B, 317BL, 315L, 317N, 318B, 18BL, 320, 320B, 320BL, 320L, 320N, 320S, 321B, 322, 322B, 322BL, 322L, 322N, 325, 325B, 325BL, 325L, 325N, 330, 330B, 330BL, 330L, 345B, 345BL, 350, 350L, 365, 365B, 375, 375L, E110, E110B, E120, E120B, E180, EL180, E200B, EL200B, E240, EL240, E240B, EL240B, E300, EL300, E300B, EL300B, M320	106 - 120
Front-Shovel Excavators	5080, 5110, 5230, 5230B	120 - 121
Integrated Toolcarriers	IT12, IT12B, IT12F, IT14B, IT14C, IT14F, IT14G, IT18, IT18B, IT18F, IT24F, IT28, IT28B, IT28F, IT28G, IT38F, IT38G, IT62G	121 - 125
Landfill Compactors	816, 816B, 816F, 826B, 826C, 826G, 836, 836C	125 - 126
Motor Graders	12, 12E, 12F, 112, 112E, 112F, 120, 120B, 120G, 120H, 12G, 12H, 130G, 135H, 14, 140B, 140G, 140H, 143H, 14D, 140, 14E, 14G, 14H, 16, 160G, 160H, 163H, 16G, 16H, 24H	126 - 134
Off-Highway Trucks	768, 768B, 768C, 769, 769B, 769C, 769D, 771D, 771C, 773, 773B, 773D, 775D, 775, 776B, 776C, 776D, 777, 777B, 777C, 777D, 783B, 785, 785B, 785C, 784B, 784C, 786, 789, 789B, 789C, 793, 793B, 793C	134 - 137
Pipelayers	561B, 561C, 561D, 571A, 571F, 571G, 572C, 572D, 572E, 572F, 572G, 578, 583H, 583K, 583R, 589, 591, 594, 594H, MD7, MD8, MDW8	137 - 138
Scrapers	611, 613, 613B, 613C, 613SC, 615, 615C, 615SC, 621, 621B, 621E, 621F, 621G, 621R, 621S, 621SC, 623, 623B, 623E, 623F, 623G, 623SC, 623SCG, 627, 627B, 627E, 627F, 627SC, 630, 630B, 630SC, 631, 631B, 631C, 631D, 631E, 631SC, 632, 633, 633B, 633C, 633D, 633SC, 637, 637B, 637D, 637E, 637SC, 639D, 639SC, 641, 641B, 641SC, 650, 650B, 651, 651B, 651C, 651E, 651SC, 657, 657B, 657E, 657SC, 660, 666B, 660B, 666, 660SC, 666SC, J621	138 - 150
Skidders	508, 515, 525, 517, 518, 518C, 520D, 522C, 520C, 525B, 527, 528, 528B, 530B, 535B, 545, FB508, FB518	150 - 151
Soil Compactors	815, 815B, 815F, 815S, 825, 825B, 825C, 825G, 835	151 - 152
Telehandlers	TH62, TH63, TH82, TH83	152
Track-Type Loaders	931, 931B, 931C, 933, 933C, 933E, 933F, 933G, 935B, 935C, 939, 939C, 941, 941B, 943, 943B, 951, 951B, 951C, 953, 953B, 953C, 955, 955C, 955E, 955F, 955H, 955K, 955L, 963, 963B, 963C, 973, 973C, 977, 977D, 977H, 977K, 977L, 983, 983B	153 - 161
Track-Type Tractors	D2, D3, D3 LGP, D3B, D3C, D4B, D4C, D4D, D4E, D4H, D4L, D4TSKH, D5, D5B, D5C, D5E, D5H, D5M, D5TSKH, D6, D6 LGP, D6B, D6C, D6D, D6E, D6G, D6H, D6M, D6R, D7, D7 LGP, D7A, D7B, D7C, D7D, 7E, D7F, D7G, D7H, D7R, D8, D8H, D8K, D8L, D8N, D8R, D9D, D9G, D9H, D9L, D9N, D9R, D10, D10N, D10R, D11N, D11R	161 - 175
Tractors	772, 772B, 776, 784C	175
Tree Harvesters	518	175
Wheel Loaders	902, 904, 906, 908, 910, 910E, 910F, 914, 914G, 916, 918F, 924F, 920, 924, 924G, 926, 926E, 928F, 928G, 930, 930R, 930T, 936, 936E, 936F, 938F, 938G, 944, 944A, 950, 950B, 950E, 950F, 950B, 950E, 950F, 950G, 960F, 960G, 962G, 966, 966A, 966B, 966C, 966D, 966E, 966F, 966G, 972G, 966R, 970F, 980, 980B, 980C, 980F, 980G, 988, 988B, 988F, 990, 992, 992B, 992C, 992D, G910, G916, G926, G936	175 - 185
Wheel Tractors	814, 814B, 814F, 814S, 824, 824B, 824C, 824S, 834S, 834U, 830M, 834, 834B, 834C	185 - 187
Alpha-Numeric Kit Listing		188 - 192
Caterpillar Individual Parts		193 - 206

All manufacturer's names, part numbers and descriptions are used for reference purposes only. We do not imply that any part shown is the product of these manufacturers. We also do not imply that the list price shown is exactly that of the manufacturer.

REPLACEMENT KITS FOR CATERPILLAR® EQUIPMENT

Agricultural Tractors							
APPLICATION	CYL #	CODE	ROD	BORE	KIT #	Misc-Serial #'s, Parts, etc.	List \$
MODEL 65, 65B, 75							
LIFT	9T2230	P-UB-10	2	4	CTC-1328816		60.48
	9T9517	P-UB-10	2	4	CTC-1328816		60.48
MODEL 65C, 65D, 70C							
LIFT	9T9517	P-UB-10	2	4	CTC-1328816		60.48
TENSIONER	1504382	P-U-10	2-3/4	9-1/4	CTC-1939271		152.61
	6E1428	P-U-10	2-3/4	9-1/4	CTC-1939271		152.61
MODEL 65E							
LIFT	9T9517	P-UB-10	2	4	CTC-1328816		60.48
TENSIONER	1483031	P-U-10	2-3/4	9-1/4	CTC-1939271		152.61
MODEL 69D							
STEERING	1100532	P-UB-10	2	3	CTC-7X2760		41.93
	9J1287	P-UB-10	2-3/8	3-3/4	CTC-7X2808		52.57
TENSIONER	4T4168	I-SP-10	4,6-1/2	5-3/4	CTC-8T4772		205.11
	9J4149	I-SP-10	4,6-1/2	5-3/4	CTC-8T4772		205.11
MODEL 73D							
STEERING RH	7J7686	P-UB-10	2-3/8	4	CTC-8T1389		31.03
TENSIONER	1455155	I-SP-10	5,7-1/2	8-1/4	CTC-8T9042		296.80
	9J2017	I-SP-10	5,7-1/2	8-1/4	CTC-8T9042		296.80
	9T3122	I-SP-10	5,7-1/2	8-1/4	CTC-8T9042		296.80
MODEL 75C							
LIFT	9T9517	P-UB-10	2	4	CTC-1328816		60.48
TENSIONER	1504382	P-U-10	2-3/4	9-1/4	CTC-1939271		152.61
	6E1428	P-U-10	2-3/4	9-1/4	CTC-1939271		152.61
MODEL 75D, 75E, 75G, 85C							
LIFT	9T9517	P-UB-10	2	4	CTC-1328816		60.48
Articulated Dump Trucks							
APPLICATION	CYL #	CODE	ROD	BORE	KIT #	Misc-Serial #'s, Parts, etc.	List \$
MODEL D25C							
HOIST	5U7777	I-U-3	3-1/2	5-1/2	CTC-5U7775		209.88
	6U6821	I-U-3	3-1/2	5-1/2	CTC-5U7775		209.88
N/A	7U9508	I-U-10	4	4-1/2	CTC-1045008		181.53
STEERING	6U1040	I-U-5	2	4-1/2	CTC-6U9552		102.61
	7U2910	I-U-5	2	4-1/2	CTC-6U9552		102.61
SUSPENSION FRONT	6U4161	I-U-10	4	4-1/2	CTC-1045008		181.53
MODEL D25D							
N/A	1511179	P-UB-10	3-1/2	4-1/2	CTC-1944399		159.42
	5U7777	I-U-3	3-1/2	5-1/2	CTC-5U7775		209.88
STEERING	1433299	I-UB-10	2	4-1/2	CTC-1857699		140.35
	1453620	P-UB-10	2	4-1/2	CTC-1857700		63.33
	7U2910	I-U-5	2	4-1/2	CTC-6U9552		102.61
SUSPENSION	1049660	P-UB-10	3-1/2	4-1/2	CTC-1942756		215.78
SUSPENSION REAR	7U9538	I-UB-10	2	4-1/2	CTC-7U9545		201.48
MODEL D30C							
HOIST	5U7777	I-U-3	3-1/2	5-1/2	CTC-5U7775		209.88
N/A	7U9508	I-U-10	4	4-1/2	CTC-1045008		181.53
STEERING	6U1040	I-U-5	2	4-1/2	CTC-6U9552		102.61
	7U2910	I-U-5	2	4-1/2	CTC-6U9552		102.61
SUSPENSION FRONT	6U4161	I-U-10	4	4-1/2	CTC-1045008		181.53

REPLACEMENT KITS FOR CATERPILLAR® EQUIPMENT

Articulated Dump Trucks							
APPLICATION	CYL #	CODE	ROD	BORE	KIT #	Misc-Serial #'s, Parts, etc.	List \$
MODEL D30D							
N/A	5U7777	I-U-3	3-1/2	5-1/2	CTC-5U7775		209.88
	7U9508	I-U-10	4	4-1/2	CTC-1045008		181.53
STEERING	7U2910	I-U-5	2	4-1/2	CTC-6U9552		102.61
SUSPENSION	2U9448	I-U-10	4	4-1/2	CTC-1045008		181.53
SUSPENSION REAR	7U9538	I-UB-10	2	4-1/2	CTC-7U9545		201.48
MODEL D35C							
HOIST	5U7777	I-U-3	3-1/2	5-1/2	CTC-5U7775		209.88
STEERING	6U1040	I-U-5	2	4-1/2	CTC-6U9552		102.61
	7U2910	I-U-5	2	4-1/2	CTC-6U9552		102.61
SUSPENSION FRONT	6U4161	I-U-10	4	4-1/2	CTC-1045008		181.53
MODEL D35HP							
HOIST	5U7777	I-U-3	3-1/2	5-1/2	CTC-5U7775		209.88
STEERING	6U1040	I-U-5	2	4-1/2	CTC-6U9552		102.61
MODEL D35HPC							
N/A	5U7777	I-U-3	3-1/2	5-1/2	CTC-5U7775		209.88
	6U4161	I-U-10	4	4-1/2	CTC-1045008		181.53
	7U2910	I-U-5	2	4-1/2	CTC-6U9552		102.61
STEERING	7U2910	I-U-5	2	4-1/2	CTC-6U9552		102.61
MODEL D40D							
STEERING	7U2910	I-U-5	2	4-1/2	CTC-6U9552		102.61
SUSPENSION REAR	7U9538	I-UB-10	2	4-1/2	CTC-7U9545		201.48
MODEL D250B							
HOIST	5U7773	I-U-3	3-1/2	5-1/2	CTC-5U7775		209.88
STEERING	5U9000	I-U-5	2	4-1/2	CTC-6U9552		102.61
MODEL D250D							
HOIST	1478507	P-UB-10	2-3/4	4	CTC-1944397		107.84
	7U6405	I-U-10	2-3/4	4	CTC-7U8075		166.98
N/A	1340006	P-UB-10	4	4-1/2	CTC-1944396		159.09
	1512611	P-UB-10	2	3	CTC-1857667		55.21
SUSPENSION	7U7230	P-UB-10	4	4-1/2	CTC-1944396		159.09
MODEL D250E							
HOIST	1218785	I-U-10	2-3/4	4	CTC-1915027		76.57
	1256187	P-U-10	3	4	CTC-1315423		138.79
	1478507	P-UB-10	2-3/4	4	CTC-1944397		107.84
N/A	1340006	P-UB-10	4	4-1/2	CTC-1944396		159.09
	1447657	P-UB-10	4	4-1/2	CTC-1944396		159.09
	1512611	P-UB-10	2	3	CTC-1857667		55.21
	7U7230	P-UB-10	4	4-1/2	CTC-1944396		159.09
STEERING	1185432	N-UB-10	2	4	CTC-1857687		97.17
	1466651	N-UB-10	2	4	CTC-1857687		97.17
SUSPENSION	1185432	N-UB-10	2	4	CTC-1857687		97.17
MODEL D300B							
HOIST	5U7773	I-U-3	3-1/2	5-1/2	CTC-5U7775		209.88
STEERING	5U9000	I-U-5	2	4-1/2	CTC-6U9552		102.61
MODEL D300B AG, D300B CANE H							
STEERING	5U9000	I-U-5	2	4-1/2	CTC-6U9552		102.61
MODEL D350B							
HOIST	5U7773	I-U-3	3-1/2	5-1/2	CTC-5U7775		209.88

REPLACEMENT KITS FOR CATERPILLAR® EQUIPMENT

Articulated Dump Trucks							
APPLICATION	CYL #	CODE	ROD	BORE	KIT #	Misc-Serial #'s, Parts, etc.	List \$
MODEL D350C							
HOIST	5U7773	I-U-3	3-1/2	5-1/2	CTC-5U7775		209.88
N/A	7U2476	I-U-10	4	4-1/2	CTC-7U2486		210.53
STEERING	6U1040	I-U-5	2	4-1/2	CTC-6U9552		102.61
	7U2910	I-U-5	2	4-1/2	CTC-6U9552		102.61
SUSPENSION	6U4161	I-U-10	4	4-1/2	CTC-1045008	Application requires 2 kits.	181.53
MODEL D350D, D350E							
N/A	5U7773	I-U-3	3-1/2	5-1/2	CTC-5U7775		209.88
	7U2476	I-U-10	4	4-1/2	CTC-7U2486		210.53
STEERING	7U2910	I-U-5	2	4-1/2	CTC-6U9552		102.61
SUSPENSION	2U8060	I-U-10	4	4-1/2	CTC-1045008		181.53
	7U7198	I-U-10	4	4-1/2	CTC-1045008		181.53
SUSPENSION REAR	7U9538	I-UB-10	2	4-1/2	CTC-7U9545		201.48
MODEL D400							
HOIST	5U7773	I-U-3	3-1/2	5-1/2	CTC-5U7775		209.88
STEERING	6U1040	I-U-5	2	4-1/2	CTC-6U9552		102.61
	7U2910	I-U-5	2	4-1/2	CTC-6U9552		102.61
MODEL D400D							
STEERING	7U2910	I-U-5	2	4-1/2	CTC-6U9552		102.61
SUSPENSION	1049660	P-UB-10	3-1/2	4-1/2	CTC-1942756		215.78
	2U8060	I-U-10	4	4-1/2	CTC-1045008		181.53
	7U7198	I-U-10	4	4-1/2	CTC-1045008		181.53
SUSPENSION REAR	7U9538	I-UB-10	2	4-1/2	CTC-7U9545		201.48
MODEL D400E							
HOIST	1434850	P-UB-10	3-1/2	5-1/2	CTC-1890263		160.33
N/A	1331584	P-UB-10	4	4-1/2	CTC-1944398		149.69
	1511179	P-UB-10	3-1/2	4-1/2	CTC-1944399		159.42
	1512611	P-UB-10	2	3	CTC-1857667		55.21
	5U7773	I-U-3	3-1/2	5-1/2	CTC-5U7775		209.88
	7U2476	I-U-10	4	4-1/2	CTC-7U2486		210.53
STEERING	1433299	I-UB-10	2	4-1/2	CTC-1857699		140.35
	1453620	P-UB-10	2	4-1/2	CTC-1857700		63.33
	7U2910	I-U-5	2	4-1/2	CTC-6U9552		102.61
SUSPENSION	1049660	P-UB-10	3-1/2	4-1/2	CTC-1942756		215.78
	2U8060	I-U-10	4	4-1/2	CTC-1045008		181.53
	7U7198	I-U-10	4	4-1/2	CTC-1045008		181.53
SUSPENSION REAR	7U9538	I-UB-10	2	4-1/2	CTC-1857699		140.35
Backhoe-Loaders							
APPLICATION	CYL #	CODE	ROD	BORE	KIT #	Misc-Serial #'s, Parts, etc.	List \$
MODEL 416							
BACKHOE BOOM	4T6878	P-UB-10	1-7/8	3-1/4	CTC-8T3589		52.70
	6E0087	P-UB-10	1-7/8	3-1/4	CTC-3E3297		64.26
	9T5219	P-UB-10	1-7/8	3-1/4	CTC-3E3297		64.26
BACKHOE BUCKET	4T5601	P-UB-10	2	3-1/4	CTC-7X2821		91.36
	6E0091	I-UB-10	2-1/2	3-1/2	CTC-3E3299		87.43
	9T2751	P-UB-10	2	3-1/4	CTC-7X2821		91.36
	9T7287	I-UB-10	2-1/2	3-1/2	CTC-3E3299		87.43
	9T7893	P-UB-10	2	3-1/4	CTC-7X2821		91.36
	9T7894	P-UB-10	2	3-1/4	CTC-7X2821		91.36

REPLACEMENT KITS FOR CATERPILLAR® EQUIPMENT

Backhoe-Loaders							
APPLICATION	CYL #	CODE	ROD	BORE	KIT #	Misc-Serial #'s, Parts, etc.	List \$
MODEL 416							
BACKHOE E-STICK	9T2215	P-UB-10	1-1/2	3	CTC-7X2745		70.81
	9T4809	P-UB-10	1-1/2	3	CTC-7X2737		70.81
	9T7893	P-UB-10	2	3-1/4	CTC-7X2821		91.36
LOAD	6E0103	P-UB-10	1-7/8	3-1/4	CTC-3E3297		64.26
	9T0415	P-UB-10	1-7/8	3-1/4	CTC-3E3297		64.26
LOADER BUCKET MP	9T4006	P-UB-10	1-1/2	3	CTC-7X2737		70.81
LOADER LIFT	9T0415	P-UB-10	1-7/8	3-1/4	CTC-8T3589		52.70
N/A	1070624	P-UB-10	1-7/8	3-1/4	CTC-3E3297		64.26
	1070625	P-UB-10	1-7/8	3-1/4	CTC-3E3297		64.26
STABILIZER	9T7391	P-UB-10	2-1/8	4	CTC-1305923		103.38
	9T7392	P-UB-10	2-1/8	4	CTC-1305923		103.38
STABILIZER LH	4T9911	P-UB-10	2-1/8	4	CTC-1305923		103.38
	6E0097	P-UB-10	2-1/8	4	CTC-1305923		103.38
	9T7070	P-UB-10	2-1/8	4	CTC-1305923		103.38
STABILIZER RH	4T6880	P-UB-10	2-1/8	4	CTC-1305923		103.38
	6E0099	P-UB-10	2-1/8	4	CTC-1305923		103.38
	9T7069	P-UB-10	2-1/8	4	CTC-1305923		103.38
STEERING	6E5190	P-UB-10	1-7/8	3	CTC-1113301		85.43
	9T1493	P-UB-10	1-7/8	3	CTC-8T3852		125.79
STICK	4T6877	P-UB-10	2-1/8	4	CTC-1305923		103.38
	6E0089	P-UB-10	2-1/2	4-1/4	CTC-3E3300		70.07
	9T2215	P-UB-10	1-1/2	3	CTC-7X2737		70.81
	9T5216	P-UB-10	2-1/8	4	CTC-1305923		103.38
	9T7063	P-UB-10	2-1/8	4	CTC-1305923		103.38
	9T7291	P-UB-10	2-1/2	4-1/4	CTC-3E3300		70.07
SWING	4T6879	P-UB-10	2-1/8	4	CTC-1305923		103.38
	6E0093	P-UB-10	2-1/8	4	CTC-1305923		103.38
SWING LH	4T6879	P-UB-10	2-1/8	4	CTC-8T3593		46.29
SWING RH	9T0529	P-UB-10	2-1/8	4	CTC-1305923		103.38
TILT	6E0105	P-UB-10	1-7/8	3-1/4	CTC-3E3297		64.26
	9T0414	P-UB-10	1-7/8	3-1/4	CTC-8T3589		52.70
	9T4005	P-UB-10	1-7/8	3-1/4	CTC-3E3297		64.26
	9T5370	P-UB-10	1-7/8	3-1/4	CTC-3E3297		64.26
MODEL 416B							
BOOM	6E0274	P-UB-10	2-3/8	4-1/2	CTC-3E8877		115.86
BUCKET	1268308	I-UB-10	2-1/2	3-1/2	CTC-3E3299		87.43
	6E0275	I-UB-10	2-1/2	3-1/2	CTC-3E3299		87.43
	6E1964	I-UB-10	2-1/2	3-1/2	CTC-3E3299		87.43
LOAD	9T0415	P-UB-10	1-7/8	3-1/4	CTC-3E3297		64.26
LOADER BUCKET MP	9T4006	P-UB-10	1-1/2	3	CTC-7X2737		70.81
N/A	1070624	P-UB-10	1-7/8	3-1/4	CTC-3E3297		64.26
	1070625	P-UB-10	1-7/8	3-1/4	CTC-3E3297		64.26
	1165354	P-UB-10	2-1/8	4	CTC-1305923		103.38
STABILIZER	1052323	P-UB-10	2-1/8	4	CTC-1305923		103.38
	1052358	P-UB-10	2-1/8	4	CTC-1305923		103.38
	9T2993	P-UB-10	2-1/8	4	CTC-9X2400		77.70
	9T2994	P-UB-10	2-1/8	4	CTC-9X2400		77.70
STABILIZER LH	1165354	P-UB-10	2-1/8	4	CTC-8T3593		46.29

REPLACEMENT KITS FOR CATERPILLAR® EQUIPMENT

Backhoe-Loaders							
APPLICATION	CYL #	CODE	ROD	BORE	KIT #	Misc-Serial #'s, Parts, etc.	List \$
MODEL 416B							
STABILIZER LH	1302364	P-UB-10	2-1/8	4	CTC-1305923		103.38
	6E0097	P-UB-10	2-1/8	4	CTC-1305923		103.38
STABILIZER RH	1165353	P-UB-10	2-1/8	4	CTC-1305923		103.38
	1302365	P-UB-10	2-1/8	4	CTC-1305923		103.38
STEERING STICK	6E0099	P-UB-10	2-1/8	4	CTC-1305923		103.38
	6E5190	P-UB-10	1-7/8	3	CTC-1113301		85.43
SWING	1065694	P-UB-10	2-1/2	4-1/2	CTC-1469860	Rod Bearing width - 1.250"	105.16
	1097020	P-UB-10	2-1/2	4-1/2	CTC-1113300		89.05
	1097021	P-UB-10	2-1/2	4-1/2	CTC-1113300		89.05
	6E0290	P-UB-10	2-1/2	4-1/2	CTC-1469860	Rod Bearing width - 1.250"	105.16
TILT	6E0404	P-UB-10	1-1/2	3	CTC-7X2737		70.81
	1166861	P-UB-10	2	4	CTC-1113302		77.57
	6E0288	P-UB-10	2	4	CTC-1113302		77.57
BOOM	6E1864	P-UB-10	2	4	CTC-1328816		60.48
	9T5490	P-UB-10	1-7/8	3-1/4	CTC-3E3297		64.26
MODEL 416C							
BUCKET	6E0274	P-UB-10	2-3/8	4-1/2	CTC-3E8877		115.86
	1268308	I-UB-10	2-1/2	3-1/2	CTC-3E3299		87.43
N/A	6E1964	I-UB-10	2-1/2	3-1/2	CTC-3E3299		87.43
	9T4006	P-UB-10	1-1/2	3	CTC-7X2737		70.81
	1070624	P-UB-10	1-7/8	3-1/4	CTC-3E3297		64.26
	1070625	P-UB-10	1-7/8	3-1/4	CTC-3E3297		64.26
	1235087	P-UB-10	2	3-1/2	CTC-7X2783		67.15
STABILIZER LH	1235091	P-UB-10	2	3	CTC-7X2760		41.93
	9T8823	I-O-3	1	2	CTC-9T0418		54.12
	1311846	P-UB-10	2-1/8	4	CTC-1305923		103.38
STABILIZER RH	1521806	P-UB-10	2-1/8	4	CTC-1305923		103.38
	1311847	P-UB-10	2-1/8	4	CTC-1305923		103.38
STEERING STICK	1521796	P-UB-10	2-1/8	4	CTC-1305923		103.38
	1156437	P-UB-10	1-3/4	2-1/2	CTC-1539054		94.09
SWING	1097020	P-UB-10	2-1/2	4-1/2	CTC-1113300		89.05
	6E0404	P-UB-10	1-1/2	3	CTC-7X2737		70.81
MODEL 426							
BACKHOE BUCKET	1166857	P-UB-10	2	4	CTC-1113302		77.57
	4T5601	P-UB-10	2	3-1/4	CTC-7X2821		91.36
	6E0091	I-UB-10	2-1/2	3-1/2	CTC-3E3299		87.43
	9T0735	P-UB-10	2	3-1/2	CTC-7X2822		62.30
	9T2751	P-UB-10	2	3-1/4	CTC-7X2821		91.36
	9T7287	I-UB-10	2-1/2	3-1/2	CTC-3E3299		87.43
BACKHOE E-STICK	9T7894	P-UB-10	2	3-1/4	CTC-7X2821		91.36
	9T2215	P-UB-10	1-1/2	3	CTC-7X2745		70.81
BACKHOE STICK	9T5220	P-UB-10	2-1/8	4	CTC-1305923		103.38
BOOM	4T6969	P-UB-10	2-1/8	3-1/2	CTC-8T3591		68.41
	6E0109	P-UB-10	2	3-1/2	CTC-7X2783		67.15
	9T5222	P-UB-10	2	3-1/2	CTC-7X2822		62.30
EXTENDABLE STICK	9T2215	P-UB-10	1-1/2	3	CTC-7X2737		70.81
	9T2215	P-UB-10	1-1/2	3	CTC-7X2745		70.81
	9T4809	P-UB-10	1-1/2	3	CTC-7X2737		70.81

REPLACEMENT KITS FOR CATERPILLAR® EQUIPMENT

Backhoe-Loaders							
APPLICATION	CYL #	CODE	ROD	BORE	KIT #	Misc-Serial #'s, Parts, etc.	List \$
MODEL 426							
EXTENDABLE STICK	9T7893	P-UB-10	2	3-1/4	CTC-7X2821		91.36
LOAD	6E0103	P-UB-10	1-7/8	3-1/4	CTC-3E3297		64.26
	9T0415	P-UB-10	1-7/8	3-1/4	CTC-3E3297		64.26
LOADER BUCKET MP	9T4006	P-UB-10	1-1/2	3	CTC-7X2737		70.81
LOADER LIFT	9T0415	P-UB-10	1-7/8	3-1/4	CTC-8T3589		52.70
LOADER TILT	9T5370	P-UB-10	1-7/8	3-1/4	CTC-8T3589		52.70
	9T5371	P-UB-10	2	3-1/2	CTC-7X2822		62.30
N/A	1070624	P-UB-10	1-7/8	3-1/4	CTC-3E3297		64.26
STABILIZER	9T7391	P-UB-10	2-1/8	4	CTC-1305923		103.38
	9T7392	P-UB-10	2-1/8	4	CTC-1305923		103.38
STABILIZER LH	4T9911	P-UB-10	2-1/8	4	CTC-1305923		103.38
	6E0097	P-UB-10	2-1/8	4	CTC-1305923		103.38
	9T7070	P-UB-10	2-1/8	4	CTC-1305923		103.38
STABILIZER RH	4T6880	P-UB-10	2-1/8	4	CTC-1305923		103.38
	6E0099	P-UB-10	2-1/8	4	CTC-1305923		103.38
	9T7069	P-UB-10	2-1/8	4	CTC-1305923		103.38
STEERING	6E5190	P-UB-10	1-7/8	3	CTC-1113301		85.43
	9T1493	P-UB-10	1-7/8	3	CTC-8T3852		125.79
STICK	4T6968	P-UB-10	2-1/8	4	CTC-1305923		103.38
	6E0111	P-UB-10	2-1/2	4-1/4	CTC-3E3300		70.07
	9T2215	P-UB-10	1-1/2	3	CTC-7X2737		70.81
	9T7066	P-UB-10	2-1/8	4	CTC-1305923		103.38
	9T7289	P-UB-10	2-1/2	4-1/4	CTC-3E3300		70.07
SWING	6E0093	P-UB-10	2-1/8	4	CTC-1305923		103.38
SWING LH	4T6879	P-UB-10	2-1/8	4	CTC-1305923		103.38
SWING RH	9T0529	P-UB-10	2-1/8	4	CTC-1305923		103.38
TILT	6E0113	P-UB-10	2	3-1/2	CTC-7X2783		67.15
	9T0735	P-UB-10	2	3-1/2	CTC-7X2822		62.30
	9T5371	P-UB-10	2	3-1/2	CTC-7X2783		67.15
MODEL 426B							
BOOM	6E1948	P-UB-10	2-1/2	5	CTC-1361967		126.36
BUCKET	1268316	I-UB-10	2-3/4	3-3/4	CTC-9X2020		70.97
	6E1809	I-UB-10	2-3/4	3-3/4	CTC-9X2020		70.97
	6E3692	I-UB-10	2-3/4	3-3/4	CTC-9X2020		70.97
LOADER BUCKET MP	9T4006	P-UB-10	1-1/2	3	CTC-7X2737		70.81
LOADER LIFT	9T0415	P-UB-10	1-7/8	3-1/4	CTC-3E3297		64.26
N/A	1070624	P-UB-10	1-7/8	3-1/4	CTC-3E3297		64.26
STABILIZER	1052323	P-UB-10	2-1/8	4	CTC-1305923		103.38
	1052358	P-UB-10	2-1/8	4	CTC-1305923		103.38
STABILIZER LH	1165354	P-UB-10	2-1/8	4	CTC-1305923		103.38
	1302364	P-UB-10	2-1/8	4	CTC-1305923		103.38
	6E0098	P-UB-10	2-1/8	4	CTC-1305923		103.38
STABILIZER RH	1165353	P-UB-10	2-1/8	4	CTC-1305923		103.38
	1302365	P-UB-10	2-1/8	4	CTC-1305923		103.38
	6E0099	P-UB-10	2-1/8	4	CTC-1305923		103.38
STEERING	6E5190	P-UB-10	1-7/8	3	CTC-1113301		85.43
STICK	6E1935	P-UB-10	2-3/4	5	CTC-3E8878		118.76
	6E3662	P-UB-10	1-1/2	3	CTC-7X2737		70.81

REPLACEMENT KITS FOR CATERPILLAR® EQUIPMENT

Backhoe-Loaders							
APPLICATION	CYL #	CODE	ROD	BORE	KIT #	Misc-Serial #'s, Parts, etc.	List \$
MODEL 426B							
SWING	1166861	P-UB-10	2	4	CTC-1113302		77.57
	6E0288	P-UB-10	2	4	CTC-1113302		77.57
	6E1864	P-UB-10	2	4	CTC-1328816		60.48
TILT	1071855	P-UB-10	2	3-1/2	CTC-7X2783		67.15
	6E0113	P-UB-10	2	3-1/2	CTC-7X2783		67.15
MODEL 426C							
BOOM	6E1948	P-UB-10	2-1/2	5	CTC-1361967		126.36
BUCKET	1268316	I-UB-10	2-3/4	3-3/4	CTC-9X2020		70.97
	6E3692	I-UB-10	2-3/4	3-3/4	CTC-9X2020		70.97
	9T4006	P-UB-10	1-1/2	3	CTC-7X2737		70.81
LIFT	1108688	P-UB-10	2	3-1/2	CTC-7X2783		67.15
	1216764	P-UB-10	2	3-1/2	CTC-7X2783		67.15
N/A	1235087	P-UB-10	2	3-1/2	CTC-7X2783		67.15
	1235091	P-UB-10	2	3	CTC-7X2760		41.93
	9T8823	I-O-3	1	2	CTC-9T0418		54.12
STABILIZER LH	1311846	P-UB-10	2-1/8	4	CTC-1305923		103.38
	1521806	P-UB-10	2-1/8	4	CTC-1305923		103.38
STABILIZER RH	1311847	P-UB-10	2-1/8	4	CTC-1305923		103.38
	1521796	P-UB-10	2-1/8	4	CTC-1305923		103.38
STEERING	1156437	P-UB-10	1-3/4	2-1/2	CTC-1539054		94.09
STICK	1535735	P-UB-10	1-1/2	3	CTC-7X2737		70.81
	6E1935	P-UB-10	2-3/4	5	CTC-3E8878		118.76
	6E3662	P-UB-10	1-1/2	3	CTC-7X2737		70.81
	1166861	P-UB-10	2	4	CTC-1113302		77.57
TILT	1071855	P-UB-10	2	3-1/2	CTC-7X2783		67.15
MODEL 428							
BACKHOE BOOM	4T6878	P-UB-10	1-7/8	3-1/4	CTC-8T3589		52.70
	4T6969	P-UB-10	2-1/8	3-1/2	CTC-8T3591		68.41
	9T5219	P-UB-10	1-7/8	3-1/4	CTC-8T3589		52.70
BACKHOE BUCKET	4T5601	P-UB-10	2	3-1/4	CTC-7X2821		91.36
	6E0091	I-UB-10	2-1/2	3-1/2	CTC-3E3299		87.43
	9T2751	P-UB-10	2	3-1/4	CTC-7X2821		91.36
	9T7287	I-UB-10	2-1/2	3-1/2	CTC-3E3299		87.43
	9T7893	P-UB-10	2	3-1/4	CTC-7X2821		91.36
	9T7894	P-UB-10	2	3-1/4	CTC-7X2821		91.36
BACKHOE E-STICK	9T2215	P-UB-10	1-1/2	3	CTC-7X2745		70.81
	9T4809	P-UB-10	1-1/2	3	CTC-7X2737		70.81
	9T7893	P-UB-10	2	3-1/4	CTC-7X2821		91.36
BACKHOE STICK	4T6877	P-UB-10	2-1/8	4	CTC-8T3593		46.29
	9T2762	P-UB-10	2-1/8	4	CTC-8T3593		46.29
	9T5216	P-UB-10	2-1/8	4	CTC-8T3593		46.29
BOOM	6E0087	P-UB-10	1-7/8	3-1/4	CTC-3E3297		64.26
	9T5219	P-UB-10	1-7/8	3-1/4	CTC-3E3297		64.26
LOAD	6E0103	P-UB-10	1-7/8	3-1/4	CTC-3E3297		64.26
	9T0415	P-UB-10	1-7/8	3-1/4	CTC-3E3297		64.26
	9T4006	P-UB-10	1-1/2	3	CTC-7X2737		70.81
LOADER BUCKET MP	9T4006	P-UB-10	1-1/2	3	CTC-7X2737		70.81
LOADER LIFT	9T0415	P-UB-10	1-7/8	3-1/4	CTC-8T3589		52.70
LOADER TILT	9T0735	P-UB-10	2	3-1/2	CTC-7X2822		62.30

REPLACEMENT KITS FOR CATERPILLAR® EQUIPMENT

Backhoe-Loaders							
APPLICATION	CYL #	CODE	ROD	BORE	KIT #	Misc-Serial #'s, Parts, etc.	List \$
MODEL 428							
LOADER TILT	9T5370	P-UB-10	1-7/8	3-1/4	CTC-8T3589		52.70
	9T5371	P-UB-10	2	3-1/2	CTC-7X2822		62.30
N/A	1070624	P-UB-10	1-7/8	3-1/4	CTC-3E3297		64.26
STABILIZER	6E0119	P-UB-10	1-3/4	2-3/4	CTC-1539053		98.31
	9T0527	P-UB-10	1-3/4	2-3/4	CTC-7X2820		51.60
	9T9709	P-UB-10	1-3/4	2-3/4	CTC-7X2820		51.60
STEERING	9T1493	P-UB-10	1-7/8	3	CTC-8T3852		125.79
STICK	4T6893	P-UB-10	2-1/8	4	CTC-1305923		103.38
	6E0089	P-UB-10	2-1/2	4-1/4	CTC-3E3300		70.07
	9T2214	P-UB-10	1-1/2	3	CTC-7X2737		70.81
	9T5215	P-UB-10	2-1/8	4	CTC-1305923		103.38
	9T5216	P-UB-10	2-1/8	4	CTC-8T3593		46.29
	9T7063	P-UB-10	2-1/8	4	CTC-1305923		103.38
	9T7291	P-UB-10	2-1/2	4-1/4	CTC-3E3300		70.07
SWING	9T0420	P-UB-10	2-1/8	4	CTC-8T3593		46.29
	9T0421	P-UB-10	2-1/8	4	CTC-8T3593		46.29
SWING LH	9T0421	P-UB-10	2-1/8	4	CTC-1305923		103.38
SWING RH	9T0420	P-UB-10	2-1/8	4	CTC-1305923		103.38
TILT	6E0113	P-UB-10	2	3-1/2	CTC-7X2783		67.15
	9T0770	P-UB-10	2	3-1/2	CTC-7X2783		67.15
	9T5371	P-UB-10	2	3-1/2	CTC-7X2783		67.15
MODEL 428B							
BOOM	6E0274	P-UB-10	2-3/8	4-1/2	CTC-3E8877		115.86
BUCKET	1268308	I-UB-10	2-1/2	3-1/2	CTC-3E3299		87.43
	6E0275	I-UB-10	2-1/2	3-1/2	CTC-3E3299		87.43
	6E1964	I-UB-10	2-1/2	3-1/2	CTC-3E3299		87.43
	6E2421	I-UB-10	2-3/4	3-3/4	CTC-9X2020		70.97
LOAD	9T0415	P-UB-10	1-7/8	3-1/4	CTC-3E3297		64.26
LOADER BUCKET MP	9T4006	P-UB-10	1-1/2	3	CTC-7X2737		70.81
N/A	1070624	P-UB-10	1-7/8	3-1/4	CTC-3E3297		64.26
SIDESHIFT	1166858	P-UB-10	2	4	CTC-1113302		77.57
SIDESHIFT RH	1166858	P-UB-10	2	4	CTC-1113302		77.57
STABILIZER	1266950	P-UB-10	1-3/4	2-3/4	CTC-1539053		98.31
	6E3483	P-UB-10	1-3/4	2-3/4	CTC-1539053		98.31
STEERING	6E5190	P-UB-10	1-7/8	3	CTC-1113301		85.43
STICK	1097021	P-UB-10	2-1/2	4-1/2	CTC-1113300		89.05
	6E0290	P-UB-10	2-1/2	4-1/2	CTC-1113300		89.05
	6E0290	P-UB-10	2-1/2	4-1/2	CTC-1469860	Rod Bearing width - 1.250"	105.16
	6E0404	P-UB-10	1-1/2	3	CTC-7X2737		70.81
SWING	1166861	P-UB-10	2	4	CTC-1113302		77.57
	6E0288	P-UB-10	2	4	CTC-1113302		77.57
SWING LH	1166858	P-UB-10	2	4	CTC-1113302		77.57
	6E1864	P-UB-10	2	4	CTC-1113302		77.57
TILT	1071855	P-UB-10	2	3-1/2	CTC-7X2783		67.15
	6E0113	P-UB-10	2	3-1/2	CTC-7X2783		67.15
MODEL 428C							
BOOM	6E0274	P-UB-10	2-3/8	4-1/2	CTC-3E8877		115.86
BUCKET	1268308	I-UB-10	2-1/2	3-1/2	CTC-3E3299		87.43

REPLACEMENT KITS FOR CATERPILLAR® EQUIPMENT

Backhoe-Loaders								
APPLICATION	CYL #	CODE	ROD	BORE	KIT #	Misc-Serial #'s, Parts, etc.	List \$	
MODEL 428C								
BUCKET N/A	1268312	I-UB-10	2-3/4	3-3/4	CTC-1361990		113.38	
	6E0275	I-UB-10	2-1/2	3-1/2	CTC-3E3299		87.43	
	6E1964	I-UB-10	2-1/2	3-1/2	CTC-3E3299		87.43	
	9T4006	P-UB-10	1-1/2	3	CTC-7X2737		70.81	
	1070624	P-UB-10	1-7/8	3-1/4	CTC-3E3297		64.26	
	1235087	P-UB-10	2	3-1/2	CTC-7X2783		67.15	
	1235091	P-UB-10	2	3	CTC-7X2760		41.93	
	9T8823	I-O-3	1	2	CTC-9T0418		54.12	
	SIDESHIFT	1166858	P-UB-10	2	4	CTC-1113302		77.57
	SIDESHIFT RH	1166858	P-UB-10	2	4	CTC-1113302		77.57
STABILIZER	1266950	P-UB-10	1-3/4	2-3/4	CTC-1539053		98.31	
STEERING	1156437	P-UB-10	1-3/4	2-1/2	CTC-1539054		94.09	
STICK	1097021	P-UB-10	2-1/2	4-1/2	CTC-1113300		89.05	
	6E0404	P-UB-10	1-1/2	3	CTC-7X2737		70.81	
SWING	1166861	P-UB-10	2	4	CTC-1113302		77.57	
TILT	1071855	P-UB-10	2	3-1/2	CTC-7X2783		67.15	
MODEL 436								
BACKHOE E-STICK	9T4809	P-UB-10	1-1/2	3	CTC-7X2737		70.81	
BOOM	6E0109	P-UB-10	2	3-1/2	CTC-7X2783		67.15	
	9T5222	P-UB-10	2	3-1/2	CTC-7X2783		67.15	
	9T5222	P-UB-10	2	3-1/2	CTC-7X2822		62.30	
LOAD	6E0103	P-UB-10	1-7/8	3-1/4	CTC-3E3297		64.26	
	9T0415	P-UB-10	1-7/8	3-1/4	CTC-3E3297		64.26	
LOADER BUCKET MP	9T4006	P-UB-10	1-1/2	3	CTC-7X2737		70.81	
LOADER LIFT	9T0415	P-UB-10	1-7/8	3-1/4	CTC-8T3589		52.70	
N/A	1070624	P-UB-10	1-7/8	3-1/4	CTC-3E3297		64.26	
STABILIZER	9T7391	P-UB-10	2-1/8	4	CTC-1305923		103.38	
	9T7392	P-UB-10	2-1/8	4	CTC-1305923		103.38	
STABILIZER LH	6E0097	P-UB-10	2-1/8	4	CTC-1305923		103.38	
	9T7070	P-UB-10	2-1/8	4	CTC-1305923		103.38	
STABILIZER RH	6E0099	P-UB-10	2-1/8	4	CTC-1305923		103.38	
	9T7069	P-UB-10	2-1/8	4	CTC-1305923		103.38	
STEERING	6E5190	P-UB-10	1-7/8	3	CTC-1113301		85.43	
	9T1493	P-UB-10	1-7/8	3	CTC-8T3852		125.79	
SWING	4T6879	P-UB-10	2-1/8	4	CTC-1305923		103.38	
	6E0093	P-UB-10	2-1/8	4	CTC-1305923		103.38	
SWING LH	4T6879	P-UB-10	2-1/8	4	CTC-8T3593		46.29	
SWING RH	9T0529	P-UB-10	2-1/8	4	CTC-1305923		103.38	
TILT	6E0113	P-UB-10	2	3-1/2	CTC-7X2783		67.15	
	9T5371	P-UB-10	2	3-1/2	CTC-7X2783		67.15	
	9T5371	P-UB-10	2	3-1/2	CTC-7X2822		62.30	
MODEL 436B								
BOOM	6E0274	P-UB-10	2-3/8	4-1/2	CTC-3E8877		115.86	
	6E1948	P-UB-10	2-1/2	5	CTC-1361967		126.36	
BUCKET	1268316	I-UB-10	2-3/4	3-3/4	CTC-9X2020		70.97	
	6E0275	I-UB-10	2-1/2	3-1/2	CTC-3E3299		87.43	
	6E1809	I-UB-10	2-3/4	3-3/4	CTC-9X2020		70.97	
	6E3692	I-UB-10	2-3/4	3-3/4	CTC-9X2020		70.97	

REPLACEMENT KITS FOR CATERPILLAR® EQUIPMENT

Backhoe-Loaders							
APPLICATION	CYL #	CODE	ROD	BORE	KIT #	Misc-Serial #'s, Parts, etc.	List \$
MODEL 436B							
LOAD	9T0415	P-UB-10	1-7/8	3-1/4	CTC-3E3297		64.26
LOADER BUCKET MP	9T4006	P-UB-10	1-1/2	3	CTC-7X2737		70.81
N/A	1070624	P-UB-10	1-7/8	3-1/4	CTC-3E3297		64.26
STABILIZER	1052323	P-UB-10	2-1/8	4	CTC-1305923		103.38
	1052358	P-UB-10	2-1/8	4	CTC-1305923		103.38
	9T2993	P-UB-10	2-1/8	4	CTC-9X2400		77.70
	9T2994	P-UB-10	2-1/8	4	CTC-9X2400		77.70
STABILIZER LH	1165354	P-UB-10	2-1/8	4	CTC-1305923		103.38
	1302364	P-UB-10	2-1/8	4	CTC-1305923		103.38
	6E0097	P-UB-10	2-1/8	4	CTC-1305923		103.38
STABILIZER RH	1165353	P-UB-10	2-1/8	4	CTC-1305923		103.38
	1302365	P-UB-10	2-1/8	4	CTC-1305923		103.38
	6E0099	P-UB-10	2-1/8	4	CTC-1305923		103.38
	9T7069	P-UB-10	2-1/8	4	CTC-8T3593		46.29
STEERING	6E5190	P-UB-10	1-7/8	3	CTC-1113301		85.43
STICK	6E1935	P-UB-10	2-3/4	5	CTC-3E8878		118.76
	6E3662	P-UB-10	1-1/2	3	CTC-7X2737		70.81
SWING	1166861	P-UB-10	2	4	CTC-1113302		77.57
	6E0288	P-UB-10	2	4	CTC-1113302		77.57
	6E1864	P-UB-10	2	4	CTC-1328816		60.48
TILT	1071855	P-UB-10	2	3-1/2	CTC-7X2783		67.15
	6E0113	P-UB-10	2	3-1/2	CTC-7X2783		67.15
MODEL 436C							
BOOM	1118211	P-UB-10	2-5/8	5-1/4	CTC-1361908		115.30
	6E1948	P-UB-10	2-1/2	5	CTC-1361967		126.36
BUCKET	1118216	I-UB-10	2-3/4	3-3/4	CTC-9X2020		70.97
	1144828	I-UB-10	2-3/4	3-3/4	CTC-9X2020		70.97
	1268316	I-UB-10	2-3/4	3-3/4	CTC-9X2020		70.97
	6E3692	I-UB-10	2-3/4	3-3/4	CTC-9X2020		70.97
	9T4006	P-UB-10	1-1/2	3	CTC-7X2737		70.81
	9T4760	I-UB-10	2-3/4	3-3/4	CTC-9X2020		70.97
	9T6305	I-UB-10	2-3/4	3-3/4	CTC-9X2020		70.97
EXTENDABLE STICK	6E5383	P-UB-10	1-3/4	3	CTC-7X2825		32.51
LIFT	1108688	P-UB-10	2	3-1/2	CTC-7X2783		67.15
	1117712	P-UB-10	2-1/4	3-3/4	CTC-1361897		103.79
	1216764	P-UB-10	2	3-1/2	CTC-7X2783		67.15
	1257895	P-UB-10	2-1/4	3-3/4	CTC-1361897		103.79
	9T2997	P-UB-10	2	3-3/4	CTC-7X7938		68.22
N/A	1235087	P-UB-10	2	3-1/2	CTC-7X2783		67.15
	1235091	P-UB-10	2	3	CTC-7X2760		41.93
STABILIZER LH	1311846	P-UB-10	2-1/8	4	CTC-1305923		103.38
	1329701	P-UB-10	2-1/8	4	CTC-1305923		103.38
	1521806	P-UB-10	2-1/8	4	CTC-1305923		103.38
	9T2994	P-UB-10	2-1/8	4	CTC-1305923		103.38
STABILIZER RH	1311847	P-UB-10	2-1/8	4	CTC-1305923		103.38
	1329700	P-UB-10	2-1/8	4	CTC-1305923		103.38
	1521796	P-UB-10	2-1/8	4	CTC-1305923		103.38
	9T2993	P-UB-10	2-1/8	4	CTC-1305923		103.38

REPLACEMENT KITS FOR CATERPILLAR® EQUIPMENT

Backhoe-Loaders							
APPLICATION	CYL #	CODE	ROD	BORE	KIT #	Misc-Serial #'s, Parts, etc.	List \$
MODEL 436C							
STEERING	1156437	P-UB-10	1-3/4	2-1/2	CTC-1539054		94.09
STICK	1118213	P-UB-10	3	5-1/4	CTC-3E3293		115.90
	1239707	P-UB-10	1-3/4	3	CTC-7X2825		32.51
	1535735	P-UB-10	1-1/2	3	CTC-7X2737		70.81
	6E1936	P-UB-10	2-3/4	5	CTC-3E8878		118.76
	6E3062	P-UB-10	3	5-1/4	CTC-3E3293		115.90
	6E3314	P-UB-10	3	5-1/4	CTC-3E3293		115.90
	6E3662	P-UB-10	1-1/2	3	CTC-7X2737		70.81
	9T8823	I-O-3	1	2	CTC-9T0418		54.12
	9T9186	P-UB-10	3	5-1/4	CTC-3E3293		115.90
SWING	1121765	P-UB-10	2	4	CTC-1113302		77.57
	1166861	P-UB-10	2	4	CTC-1113302		77.57
	6E5219	P-UB-10	2	4	CTC-1113302		77.57
SWING LH	9T1701	P-UB-10	2-1/8	4	CTC-9X2400		77.70
SWING RH	9T1230	P-UB-10	2-1/8	4	CTC-9X2400		77.70
TILT	1007844	P-UB-10	2	4	CTC-1328816		60.48
	1071855	P-UB-10	2	3-1/2	CTC-7X2783		67.15
	9T2995	P-UB-10	2	4	CTC-1328816		60.48
MODEL 438							
BACKHOE BUCKET	4T5601	P-UB-10	2	3-1/4	CTC-7X2821		91.36
	9T2751	P-UB-10	2	3-1/4	CTC-7X2821		91.36
	9T7893	P-UB-10	2	3-1/4	CTC-7X2821		91.36
	9T7894	P-UB-10	2	3-1/4	CTC-7X2821		91.36
BACKHOE E-STICK	9T2215	P-UB-10	1-1/2	3	CTC-7X2745		70.81
	9T4809	P-UB-10	1-1/2	3	CTC-7X2737		70.81
BOOM	6E0087	P-UB-10	1-7/8	3-1/4	CTC-3E3297		64.26
	9T5219	P-UB-10	1-7/8	3-1/4	CTC-3E3297		64.26
	9T5219	P-UB-10	1-7/8	3-1/4	CTC-8T3589		52.70
EXTENDABLE STICK	9T2215	P-UB-10	1-1/2	3	CTC-7X2737		70.81
	9T2215	P-UB-10	1-1/2	3	CTC-7X2745		70.81
	9T4809	P-UB-10	1-1/2	3	CTC-7X2737		70.81
	9T7893	P-UB-10	2	3-1/4	CTC-7X2821		91.36
LOAD	6E0103	P-UB-10	1-7/8	3-1/4	CTC-3E3297		64.26
	9T0415	P-UB-10	1-7/8	3-1/4	CTC-3E3297		64.26
LOADER BUCKET MP	9T4006	P-UB-10	1-1/2	3	CTC-7X2737		70.81
LOADER LIFT	9T0415	P-UB-10	1-7/8	3-1/4	CTC-8T3589		52.70
N/A	1070624	P-UB-10	1-7/8	3-1/4	CTC-3E3297		64.26
STABILIZER	6E0119	P-UB-10	1-3/4	2-3/4	CTC-1539053		98.31
	9T0527	P-UB-10	1-3/4	2-3/4	CTC-7X2820		51.60
	9T9709	P-UB-10	1-3/4	2-3/4	CTC-7X2820		51.60
STEERING	9T1493	P-UB-10	1-7/8	3	CTC-8T3852		125.79
STICK	6E0089	P-UB-10	2-1/2	4-1/4	CTC-3E3300		70.07
	9T2215	P-UB-10	1-1/2	3	CTC-7X2737		70.81
	9T7291	P-UB-10	2-1/2	4-1/4	CTC-3E3300		70.07
SWING	9T0420	P-UB-10	2-1/8	4	CTC-8T3593		46.29
	9T0421	P-UB-10	2-1/8	4	CTC-8T3593		46.29
SWING LH	9T0421	P-UB-10	2-1/8	4	CTC-1305923		103.38
SWING RH	9T0420	P-UB-10	2-1/8	4	CTC-1305923		103.38

REPLACEMENT KITS FOR CATERPILLAR® EQUIPMENT

Backhoe-Loaders							
APPLICATION	CYL #	CODE	ROD	BORE	KIT #	Misc-Serial #'s, Parts, etc.	List \$
MODEL 438							
TILT	6E0113	P-UB-10	2	3-1/2	CTC-7X2783		67.15
	9T5371	P-UB-10	2	3-1/2	CTC-7X2783		67.15
	9T5371	P-UB-10	2	3-1/2	CTC-7X2822		62.30
MODEL 438B							
BOOM	6E0274	P-UB-10	2-3/8	4-1/2	CTC-3E8877		115.86
BUCKET	1268308	I-UB-10	2-1/2	3-1/2	CTC-3E3299		87.43
	1268312	I-UB-10	2-3/4	3-3/4	CTC-1361990		113.38
	6E0275	I-UB-10	2-1/2	3-1/2	CTC-3E3299		87.43
	6E1964	I-UB-10	2-1/2	3-1/2	CTC-3E3299		87.43
	6E2421	I-UB-10	2-3/4	3-3/4	CTC-9X2020		70.97
	6E3693	I-UB-10	2-3/4	3-3/4	CTC-1361990		113.38
	9T4006	P-UB-10	1-1/2	3	CTC-7X2737		70.81
LOADER BUCKET MP	9T0415	P-UB-10	1-7/8	3-1/4	CTC-3E3297		64.26
N/A	1070624	P-UB-10	1-7/8	3-1/4	CTC-3E3297		64.26
SIDESHIFT	1166858	P-UB-10	2	4	CTC-1113302		77.57
SIDESHIFT RH	1166858	P-UB-10	2	4	CTC-1113302		77.57
STABILIZER	1266950	P-UB-10	1-3/4	2-3/4	CTC-1539053		98.31
	6E3483	P-UB-10	1-3/4	2-3/4	CTC-1539053		98.31
STICK	1097021	P-UB-10	2-1/2	4-1/2	CTC-1113300		89.05
	6E0290	P-UB-10	2-1/2	4-1/2	CTC-1113300		89.05
	6E0290	P-UB-10	2-1/2	4-1/2	CTC-1469860	Rod Bearing width - 1.250"	105.16
SWING	6E0404	P-UB-10	1-1/2	3	CTC-7X2737		70.81
	1166861	P-UB-10	2	4	CTC-1113302		77.57
SWING LH	6E0288	P-UB-10	2	4	CTC-1113302		77.57
	6E1864	P-UB-10	2	4	CTC-1113302		77.57
TILT	1071855	P-UB-10	2	3-1/2	CTC-7X2783		67.15
	6E0113	P-UB-10	2	3-1/2	CTC-7X2783		67.15
MODEL 438C							
BOOM	6E0274	P-UB-10	2-3/8	4-1/2	CTC-3E8877		115.86
BUCKET	1268312	I-UB-10	2-3/4	3-3/4	CTC-1361990		113.38
	6E1964	I-UB-10	2-1/2	3-1/2	CTC-3E3299		87.43
	6E2421	I-UB-10	2-3/4	3-3/4	CTC-9X2020		70.97
	6E3693	I-UB-10	2-3/4	3-3/4	CTC-1361990		113.38
	9T4006	P-UB-10	1-1/2	3	CTC-7X2737		70.81
N/A	1070624	P-UB-10	1-7/8	3-1/4	CTC-3E3297		64.26
	1235087	P-UB-10	2	3-1/2	CTC-7X2783		67.15
	1235091	P-UB-10	2	3	CTC-7X2760		41.93
	9T8823	I-O-3	1	2	CTC-9T0418		54.12
SIDESHIFT	1166858	P-UB-10	2	4	CTC-1113302		77.57
SIDESHIFT RH	1166858	P-UB-10	2	4	CTC-1113302		77.57
STABILIZER	1266950	P-UB-10	1-3/4	2-3/4	CTC-1539053		98.31
STICK	1097021	P-UB-10	2-1/2	4-1/2	CTC-1113300		89.05
	6E0404	P-UB-10	1-1/2	3	CTC-7X2737		70.81
SWING	1166861	P-UB-10	2	4	CTC-1113302		77.57
TILT	1071855	P-UB-10	2	3-1/2	CTC-7X2783		67.15
MODEL 446							
BACKHOE BUCKET	9T6305	I-UB-10	2-3/4	3-3/4	CTC-9X2020		70.97
BOOM	1118211	P-UB-10	2-5/8	5-1/4	CTC-1361908		115.30

REPLACEMENT KITS FOR CATERPILLAR® EQUIPMENT

CATERPILLAR®

Backhoe-Loaders							
APPLICATION	CYL #	CODE	ROD	BORE	KIT #	Misc-Serial #'s, Parts, etc.	List \$
MODEL 446							
BUCKET	1144828	I-UB-10	2-3/4	3-3/4	CTC-9X2020		70.97
EXTENDABLE STICK	6E5383	P-UB-10	1-3/4	3	CTC-7X2825		32.51
	9T2107	P-UB-10	1-3/4	3	CTC-7X2825		32.51
LIFT	1117712	P-UB-10	2-1/4	3-3/4	CTC-1361897		103.79
	1257895	P-UB-10	2-1/4	3-3/4	CTC-1361897		103.79
	9T2997	P-UB-10	2	3-3/4	CTC-7X7938		68.22
STABILIZER	9T2993	P-UB-10	2-1/8	4	CTC-9X2400		77.70
	9T2994	P-UB-10	2-1/8	4	CTC-9X2400		77.70
STABILIZER LH	1329701	P-UB-10	2-1/8	4	CTC-1305923		103.38
	9T2994	P-UB-10	2-1/8	4	CTC-1305923		103.38
STABILIZER RH	1329700	P-UB-10	2-1/8	4	CTC-1305923		103.38
	9T2993	P-UB-10	2-1/8	4	CTC-1305923		103.38
STICK	1118213	P-UB-10	3	5-1/4	CTC-3E3293		115.90
	6E3062	P-UB-10	3	5-1/4	CTC-3E3293		115.90
	6E3314	P-UB-10	3	5-1/4	CTC-3E3293		115.90
	9T9186	P-UB-10	3	5-1/4	CTC-3E3293		115.90
SWING	1121765	P-UB-10	2	4	CTC-1113302		77.57
	6E5219	P-UB-10	2	4	CTC-1113302		77.57
SWING LH	9T1701	P-UB-10	2-1/8	4	CTC-9X2400		77.70
SWING RH	9T1230	P-UB-10	2-1/8	4	CTC-9X2400		77.70
TILT	1007844	P-UB-10	2	4	CTC-1113302		77.57
	1007844	P-UB-10	2	4	CTC-1328816		60.48
	9T2995	P-UB-10	2	4	CTC-1113302		77.57
	9T2995	P-UB-10	2	4	CTC-1328816		60.48
MODEL 446B							
BOOM	1118211	P-UB-10	2-5/8	5-1/4	CTC-1361908		115.30
BUCKET	1118217	I-UB-10	2-3/4	3-3/4	CTC-9X2020		70.97
	1144828	I-UB-10	2-3/4	3-3/4	CTC-9X2020		70.97
	9T4760	I-UB-10	2-3/4	3-3/4	CTC-9X2020		70.97
	9T6305	I-UB-10	2-3/4	3-3/4	CTC-9X2020		70.97
	6E5383	P-UB-10	1-3/4	3	CTC-7X2825		32.51
EXTENDABLE STICK	1117712	P-UB-10	2-1/4	3-3/4	CTC-1361897		103.79
LIFT	1257895	P-UB-10	2-1/4	3-3/4	CTC-1361897		103.79
	9T2997	P-UB-10	2	3-3/4	CTC-7X7938		68.22
SIDESHIFT	1121765	P-UB-10	2	4	CTC-1113302		77.57
STABILIZER LH	1329701	P-UB-10	2-1/8	4	CTC-1305923		103.38
	9T2994	P-UB-10	2-1/8	4	CTC-1305923		103.38
STABILIZER RH	1329700	P-UB-10	2-1/8	4	CTC-1305923		103.38
	9T2993	P-UB-10	2-1/8	4	CTC-1305923		103.38
STICK	1118213	P-UB-10	3	5-1/4	CTC-3E3293		115.90
	1239707	P-UB-10	1-3/4	3	CTC-7X2825		32.51
	6E3062	P-UB-10	3	5-1/4	CTC-3E3293		115.90
	6E3314	P-UB-10	3	5-1/4	CTC-3E3293		115.90
	9T9186	P-UB-10	3	5-1/4	CTC-3E3293		115.90
	9T9186	P-UB-10	3	5-1/4	CTC-3E3293		115.90
SWING	1121765	P-UB-10	2	4	CTC-1113302		77.57
	6E5219	P-UB-10	2	4	CTC-1113302		77.57
SWING LH	9T1701	P-UB-10	2-1/8	4	CTC-9X2400		77.70
SWING RH	9T1230	P-UB-10	2-1/8	4	CTC-9X2400		77.70

REPLACEMENT KITS FOR CATERPILLAR® EQUIPMENT

Backhoe-Loaders							
APPLICATION	CYL #	CODE	ROD	BORE	KIT #	Misc-Serial #'s, Parts, etc.	List \$
MODEL 446B							
TILT	1007844	P-UB-10	2	4	CTC-1113302		77.57
	1007844	P-UB-10	2	4	CTC-1328816		60.48
	9T2995	P-UB-10	2	4	CTC-1328816		60.48
Bulldozers							
APPLICATION	CYL #	CODE	ROD	BORE	KIT #	Misc-Serial #'s, Parts, etc.	List \$
MODEL 3P							
TILT	9J8674	P-UB-10	1-1/2	3-1/2	CTC-7X2752		62.21
MODEL 3S							
TILT	8J6893	P-UB-10	2	4	CTC-7X2789		66.51
	9J8674	P-UB-10	1-1/2	3-1/2	CTC-7X2752		62.21
MODEL 4S							
DOZER TILT	5J1603	P-V-10	2	4-3/4	CTC-7X2677		76.32
MODEL 5A							
LIFT	7J8299	P-UB-10	2-1/2	4	CTC-7X2659		102.22
MODEL 5S							
LIFT	7J8302	P-UB-10	2-1/2	4	CTC-7X2659		102.22
TILT	2J1402	P-UB-10	3	6-1/2	CTC-7X2694		103.59
MODEL 6							
LIFT	7J7974	P-UB-10	1-1/2	4	CTC-7X2738		57.03
RIPPER	2K3663	P-UB-10	2-1/2	7-1/4	CTC-7X2661		117.98
MODEL 6S							
TILT	2J1402	P-UB-10	3	6-1/2	CTC-7X2694		103.59
MODEL 7A							
TILT	5J7929	P-UB-10	2-1/2	6	CTC-7X2692		107.12
MODEL 7S, 7U							
DOZER TILT	3G4533	P-UB-10	3	6-1/2	CTC-1126550		115.57
	3J9694	P-U-10	3-1/2	8-1/4	CTC-7X2720		117.81
	6J9752	P-UB-10	3	6-1/2	CTC-1126550		115.57
	9J8748	P-UB-10	3	6-1/2	CTC-1126550		115.57
MODEL 7SU							
DOZER TILT	3G4533	P-UB-10	3	6-1/2	CTC-1126550		115.57
MODEL 8A							
DOZER LIFT	9J8802	P-UB-10	3-1/2	7-1/2	CTC-7X2722		121.12
MODEL 8B							
PIN PULLER	4J5057	P-V-10	1-1/4	4	CTC-8T1480		53.94
MODEL 8D							
PIN PULLER RIPPER	8J2071	P-UB-10	1-1/2	4	CTC-7X2738		57.03
MODEL 8R							
TILT	7J0192	P-UB-10	3-1/2	8-1/4	CTC-7X2721		189.85
MODEL 8S							
DOZER TILT	2J3894	P-U-10	3-1/2	8-1/4	CTC-7X2720		117.81
	3G5707	P-UB-10	3-1/2	8-1/4	CTC-7X2721		189.85
LIFT LH	5J9378	P-UB-10	2-1/2	5	CTC-7X2675		81.02
LIFT RH	5J9708	P-UB-10	2-1/2	5	CTC-7X2675		81.02
TILT	6J2472	P-UB-10	3-1/2	8-1/4	CTC-7X2728		114.08
	7J0192	P-UB-10	3-1/2	8-1/4	CTC-7X2721		189.85
	8J8682	P-UB-10	3-1/2	8-1/4	CTC-7X2721		189.85

REPLACEMENT KITS FOR CATERPILLAR® EQUIPMENT

Bulldozers								
APPLICATION	CYL #	CODE	ROD	BORE	KIT #	Misc-Serial #'s, Parts, etc.	List \$	
MODEL 8U								
DOZER TILT	6J2472	P-UB-10	3-1/2	8-1/4	CTC-7X2728		114.08	
	2J3894	P-U-10	3-1/2	8-1/4	CTC-7X2720		117.81	
	3G5707	P-UB-10	3-1/2	8-1/4	CTC-7X2721		189.85	
TILT	7J0192	P-UB-10	3-1/2	8-1/4	CTC-7X2721		189.85	
	8J8682	P-UB-10	3-1/2	8-1/4	CTC-7X2721		189.85	
MODEL 9B								
PIN PULLER	4J5057	P-V-10	1-1/4	4	CTC-8T1480		53.94	
MODEL 9R								
TILT	6J1570	P-UB-10	3-1/2	8-1/4	CTC-7X2721		189.85	
MODEL 9S, 9U								
DOZER TILT	2J6705	P-U-10	3-1/2	8-1/4	CTC-7X2720		117.81	
	3G8661	P-UB-10	4	9-1/4	CTC-7X2799		233.31	
TILT	6J1570	P-UB-10	3-1/2	8-1/4	CTC-7X2721		189.85	
Excavators								
APPLICATION	CYL #	CODE	ROD	BORE	KIT #	Misc-Serial #'s, Parts, etc.	List \$	
MODEL 215, 215C, 219								
BOOM	8J8613	P-UB-14	2-3/4	4-1/2	CTC-7X2683		119.14	
BUCKET	8J8612	P-UB-14	2-3/4	4-1/2	CTC-7X2685		107.10	
CLAMSHELL	9J5832	P-UB-14	3-1/4	6-1/2	CTC-7X2713	215 Only	87.15	
STICK	8J8611	P-UB-14	3-1/2	5-1/2	CTC-7X2726		98.05	
TRACK ADJUSTER		TRK ADJ			CTC-FIG3400		39.00	
		TRK ADJ			CTC-FIG3404		81.99	
MODEL 215B								
BOOM	3G2996	P-UB-10	3-1/4	5-1/2	CTC-7X2705		168.24	
	8J8613	P-UB-14	2-3/4	4-1/2	CTC-7X2683		119.14	
BUCKET	8J8612	P-UB-14	2-3/4	4-1/2	CTC-7X2685		107.10	
CLAMSHELL	9J5832	P-UB-14	3-1/4	6-1/2	CTC-7X2713		87.15	
STICK	8J8611	P-UB-14	3-1/2	5-1/2	CTC-7X2726		98.05	
TRACK ADJUSTER		TRK ADJ			CTC-FIG3400		39.00	
MODEL 215D								
BOOM	8J8613	P-UB-14	2-3/4	4-1/2	CTC-7X2683		119.14	
STICK	9T9280	P-UB-14	3-1/2	5-1/2	CTC-7X2726		98.05	
TRACK ADJUSTER		TRK ADJ			CTC-FIG3400		39.00	
		TRK ADJ			CTC-FIG3404		81.99	
MODEL 219D								
STICK	9T9280	P-UB-14	3-1/2	5-1/2	CTC-7X2726		98.05	
TRACK ADJUSTER		TRK ADJ			CTC-FIG3400		39.00	
		TRK ADJ			CTC-FIG3404		81.99	
MODEL 225								
BOOM	3G2996	P-UB-10	3-1/4	5-1/2	CTC-7X2705		168.24	
	3G7384	P-UB-10	3-1/4	5-1/2	CTC-7X2705		168.24	
	6E3833	P-UB-10	3-1/4	5-1/2	CTC-7X2705		168.24	
	6E3836	P-UB-10	3-1/4	5-1/2	CTC-7X2705		168.24	
	8J1698	P-UB-10	3-1/4	5-1/2	CTC-7X2705		168.24	
	8J1698	P-UB-10	3-1/4	5-1/2	CTC-7X2823		154.60	
	BUCKET	6E6007	P-UB-10	3-1/4	5-1/2	CTC-7X2705		168.24
		8J2566	P-UB-10	3-1/4	5-1/2	CTC-7X2705		168.24
8J8612		P-UB-14	2-3/4	4-1/2	CTC-7X2685		107.10	

REPLACEMENT KITS FOR CATERPILLAR® EQUIPMENT

Excavators							
APPLICATION	CYL #	CODE	ROD	BORE	KIT #	Misc-Serial #'s, Parts, etc.	List \$
MODEL 225							
BUCKET	9J7006	P-UB-10	3-1/4	5-1/2	CTC-1002931		258.51
CLAMSHELL	9J5153	P-UB-14	3-1/2	8-1/4	CTC-7X2727		224.53
CONVEYOR SWING	9J5153	P-UB-14	3-1/2	8-1/4	CTC-7X2727		224.53
STICK	8J1719	P-UB-10	3-3/4	6	CTC-7X2794		252.04
	9J1755	P-UB-10	3-3/4	6	CTC-1002939		319.47
	9T9744	P-UB-10	3-3/4	6	CTC-3E8888		206.44
MODEL 225B							
BOOM	3G2996	P-UB-10	3-1/4	5-1/2	CTC-7X2705		168.24
	6E3833	P-UB-10	3-1/4	5-1/2	CTC-7X2705		168.24
	8J1698	P-UB-10	3-1/4	5-1/2	CTC-7X2705		168.24
	8J1698	P-UB-10	3-1/4	5-1/2	CTC-7X2823		154.60
	9T5230	P-UB-10	3-1/2	6	CTC-7X7735		143.63
BUCKET	6E6007	P-UB-10	3-1/4	5-1/2	CTC-7X2705		168.24
	8J8612	P-UB-14	2-3/4	4-1/2	CTC-7X2685		107.10
	9J7006	P-UB-10	3-1/4	5-1/2	CTC-1002931		258.51
	9J7006	P-UB-10	3-1/4	5-1/2	CTC-1002932		258.82
	9J7006	P-UB-14	3-1/4	5-1/2	CTC-7X2709		105.34
STICK	9J1755	P-UB-10	3-3/4	6	CTC-1002939		319.47
	9J1755	P-UB-10	3-3/4	6	CTC-7X2794		252.04
	9T9744	P-UB-10	3-3/4	6	CTC-3E8888		206.44
TRACK ADJUSTER		TRK ADJ			CTC-FIG3400		39.00
MODEL 225D							
BOOM	3G2996	P-UB-10	3-1/4	5-1/2	CTC-7X2705		168.24
	9T5230	P-UB-10	3-1/2	6	CTC-7X7735		143.63
BUCKET	6E6007	P-UB-10	3-1/4	5-1/2	CTC-7X2705		168.24
	8J8612	P-UB-14	2-3/4	4-1/2	CTC-7X2685		107.10
	9J7006	P-UB-10	3-1/4	5-1/2	CTC-1002931		258.51
	9J7006	P-UB-10	3-1/4	5-1/2	CTC-1002932		258.82
	9J7006	P-UB-14	3-1/4	5-1/2	CTC-7X2709		105.34
STICK	6E6009	P-UB-10	3-3/4	6	CTC-1002939		319.47
	9J1755	P-UB-10	3-3/4	6	CTC-1002939		319.47
	9J1755	P-UB-10	3-3/4	6	CTC-7X2794		252.04
	9T9744	P-UB-10	3-3/4	6	CTC-1002939		319.47
	9T9744	P-UB-10	3-3/4	6	CTC-3E8888		206.44
TRACK ADJUSTER		TRK ADJ			CTC-FIG3400		39.00
MODEL 227							
ARM	1U4732	P-UB-14	3-3/4	6	CTC-7X2814		129.48
BOOM	3G2996	P-UB-10	3-1/4	5-1/2	CTC-7X2705		168.24
	3G7264	P-UB-10	3-1/4	5-1/2	CTC-7X2705		168.24
	6E3833	P-UB-10	3-1/4	5-1/2	CTC-7X2705		168.24
	8J1698	P-UB-10	3-1/4	5-1/2	CTC-7X2705		168.24
	8J1698	P-UB-10	3-1/4	5-1/2	CTC-7X2823		154.60
BUCKET	6E6007	P-UB-10	3-1/4	5-1/2	CTC-7X2705		168.24
	9J7006	P-UB-10	3-1/4	5-1/2	CTC-1002931		258.51
	9J7006	P-UB-10	3-1/4	5-1/2	CTC-1002932		258.82
	9J7006	P-UB-14	3-1/4	5-1/2	CTC-7X2709		105.34
GRAPPLE	3G5672	P-UB-10	1-3/4	3	CTC-7X2791		57.77
SHEAR	3G2656	P-UB-14	3-1/4	6-1/2	CTC-7X2713		87.15

REPLACEMENT KITS FOR CATERPILLAR® EQUIPMENT

Excavators							
APPLICATION	CYL #	CODE	ROD	BORE	KIT #	Misc-Serial #'s, Parts, etc.	List \$
MODEL 227							
STICK	1U4731	P-UB-10	3-3/4	6	CTC-1002939		319.47
	9J1755	P-UB-10	3-3/4	6	CTC-1002939		319.47
	9J1755	P-UB-10	3-3/4	6	CTC-7X2794		252.04
	9T9744	P-UB-10	3-3/4	6	CTC-3E8888		206.44
TILT	3G9241	P-UB-10	2-1/2	4-1/2	CTC-7X2668		110.88
MODEL 229							
ARM	1U4732	P-UB-14	3-3/4	6	CTC-7X2814		129.48
BOOM	3G2996	P-UB-10	3-1/4	5-1/2	CTC-7X2705		168.24
	3G7264	P-UB-10	3-1/4	5-1/2	CTC-7X2705		168.24
	6E3833	P-UB-10	3-1/4	5-1/2	CTC-7X2705		168.24
	8J1698	P-UB-10	3-1/4	5-1/2	CTC-7X2705		168.24
	8J1698	P-UB-10	3-1/4	5-1/2	CTC-7X2823		154.60
	9T5230	P-UB-10	3-1/2	6	CTC-7X7735		143.63
BUCKET	6E6007	P-UB-10	3-1/4	5-1/2	CTC-7X2705		168.24
	9J7006	P-UB-10	3-1/4	5-1/2	CTC-1002931		258.51
	9J7006	P-UB-10	3-1/4	5-1/2	CTC-1002932		258.82
	9J7006	P-UB-14	3-1/4	5-1/2	CTC-7X2709		105.34
STICK	9J1755	P-UB-10	3-3/4	6	CTC-1002939		319.47
	9J1755	P-UB-10	3-3/4	6	CTC-7X2794		252.04
	9T9744	P-UB-10	3-3/4	6	CTC-3E8888		206.44
TRACK ADJUSTER		TRK ADJ			CTC-FIG3400		39.00
MODEL 229D							
BOOM	9T9371	P-UB-10	4	6	CTC-9X6261		185.19
	9T9371	P-UB-10	4	6	CTC-9X6263		152.57
BUCKET	6E6007	P-UB-10	3-1/4	5-1/2	CTC-7X2705		168.24
	9J7006	P-UB-10	3-1/4	5-1/2	CTC-1002931		258.51
	9J7006	P-UB-10	3-1/4	5-1/2	CTC-1002932		258.82
	9J7006	P-UB-14	3-1/4	5-1/2	CTC-7X2709		105.34
STICK	6E6009	P-UB-10	3-3/4	6	CTC-1002939		319.47
	9T9744	P-UB-10	3-3/4	6	CTC-1002939		319.47
	9T9744	P-UB-10	3-3/4	6	CTC-3E8888		206.44
MODEL 231D							
BOOM	1052921	P-UB-10	4	6	CTC-9X6261		185.19
	6E3473	P-UB-10	4-1/4	6-1/2	CTC-8T1461		148.40
	8J4589	P-UB-10	4-1/4	6-1/2	CTC-1002934		262.07
	8J4589	P-UB-10	4-1/4	6-1/2	CTC-1002935		266.77
	8J4589	P-UB-10	4-1/4	6-1/2	CTC-8T1461		148.40
	9T9371	P-UB-10	4	6	CTC-9X6261		185.19
	9T9371	P-UB-10	4	6	CTC-9X6263		152.57
BUCKET	6E5021	P-UB-10	4	6	CTC-9X6261		185.19
	9T9514	P-UB-10	4	6	CTC-9X6261		185.19
MODEL 235							
BOOM	1024210	P-UB-10	4-1/4	6-1/2	CTC-8T1461		148.40
	3G3524	P-UB-14	4-3/4	7-1/4	CTC-8T1545		188.44
	4T1689	P-UB-10	4-1/4	6-1/2	CTC-8T1461		148.40
	4T1921	P-UB-10	4-1/4	6-1/2	CTC-8T1461		148.40
	6C5856	P-UB-10	4-1/4	6-1/2	CTC-8T1461		148.40
	6C5857	P-UB-10	4-1/4	6-1/2	CTC-8T1461		148.40

REPLACEMENT KITS FOR CATERPILLAR® EQUIPMENT

Excavators							
APPLICATION	CYL #	CODE	ROD	BORE	KIT #	Misc-Serial #'s, Parts, etc.	List \$
MODEL 235							
BOOM	8J4589	P-UB-10	4-1/4	6-1/2	CTC-1002934		262.07
	8J4589	P-UB-10	4-1/4	6-1/2	CTC-1002935		266.77
	8J4589	P-UB-10	4-1/4	6-1/2	CTC-8T1461		148.40
	9J2153	P-UB-10	4-1/4	6-1/2	CTC-8T1461		148.40
	9T9995	P-UB-10	4-1/4	6-1/2	CTC-8T1461		148.40
	9T9995	P-UB-10	4-1/4	6-1/2	CTC-9X6379		206.99
BOTTOM DUMP	1024216	P-UB-14	4-3/4	6-1/2	CTC-8T1462		131.90
	4T0483	P-UB-14	3	7-1/4	CTC-7X2699		140.39
BUCKET	1024216	P-UB-14	4-3/4	6-1/2	CTC-8T1462		131.90
	4T2536	P-UB-14	4-3/4	6-1/2	CTC-8T1462		131.90
	8J8918	P-UB-10	4-3/4	6-1/2	CTC-7X7719		173.24
	9J4100	P-UB-14	4-3/4	6-1/2	CTC-8T1462		131.90
	9J8153	P-UB-14	4-3/4	6	CTC-8T1908		142.04
	1U2813	P-UB-10	2-1/2	4	CTC-7X2665		108.85
PIN PULLER	9J4882	P-UB-10	4	5	CTC-7X2816		164.89
SLAVE	3G5646	P-UB-10	5	7-3/4	CTC-8T1479		235.32
STICK	6E5096	P-UB-10	5	7-3/4	CTC-3E8887		292.85
	8J5603	P-UB-10	5	7-3/4	CTC-8T1479		235.32
	9J1755	P-UB-10	3-3/4	6	CTC-1002939		319.47
	9J7850	P-UB-10	5	7-3/4	CTC-8T1479		235.32
	9T1387	P-UB-10	5	7-3/4	CTC-8T1479		235.32
	9T9354	P-UB-10	5	7-3/4	CTC-3E8887		292.85
	9T9744	P-UB-10	3-3/4	6	CTC-3E8888		206.44
	MODEL 235 FS						
BOOM	4T1921	P-UB-10	4-1/4	6-1/2	CTC-8T1461		148.40
	8J4589	P-UB-10	4-1/4	6-1/2	CTC-1002934		262.07
	8J4589	P-UB-10	4-1/4	6-1/2	CTC-1002935		266.77
	8J4589	P-UB-10	4-1/4	6-1/2	CTC-8T1461		148.40
	9J2153	P-UB-10	4-1/4	6-1/2	CTC-8T1461		148.40
	9T9995	P-UB-10	4-1/4	6-1/2	CTC-8T1461		148.40
BOTTOM DUMP	4T0483	P-UB-14	3	7-1/4	CTC-7X2699		140.39
	9J4697	P-UB-14	3	7-1/4	CTC-7X2699		140.39
BUCKET	4T2536	P-UB-14	4-3/4	6-1/2	CTC-8T1462		131.90
	9J4100	P-UB-10	4-3/4	6-1/2	CTC-7X7718		163.83
	9J4100	P-UB-10	4-3/4	6-1/2	CTC-7X7719		173.24
	9J4100	P-UB-14	4-3/4	6-1/2	CTC-8T1462		131.90
	9J8153	P-UB-14	4-3/4	6	CTC-8T1908		142.04
	9J4882	P-UB-10	4	5	CTC-7X2816		164.89
SLAVE	3G5646	P-UB-10	5	7-3/4	CTC-8T1479		235.32
STICK							
MODEL 235B							
BOOM	1024210	P-UB-10	4-1/4	6-1/2	CTC-8T1461		148.40
	4T1689	P-UB-10	4-1/4	6-1/2	CTC-8T1461		148.40
	4T1921	P-UB-10	4-1/4	6-1/2	CTC-8T1461		148.40
	6C5856	P-UB-10	4-1/4	6-1/2	CTC-8T1461		148.40
	6C5857	P-UB-10	4-1/4	6-1/2	CTC-8T1461		148.40
	9T9995	P-UB-10	4-1/4	6-1/2	CTC-8T1461		148.40
	9T9995	P-UB-10	4-1/4	6-1/2	CTC-9X6379		206.99
	9T9995	P-UB-10	4-1/4	6-1/2	CTC-9X6379		206.99
BOTTOM DUMP	4T0483	P-UB-14	3	7-1/4	CTC-7X2699		140.39
BUCKET	1024217	P-UB-14	4-3/4	6-1/2	CTC-8T1462		131.90

REPLACEMENT KITS FOR CATERPILLAR® EQUIPMENT

Excavators								
APPLICATION	CYL #	CODE	ROD	BORE	KIT #	Misc-Serial #'s, Parts, etc.	List \$	
MODEL 235B								
BUCKET	4T2536	P-UB-14	4-3/4	6-1/2	CTC-8T1462		131.90	
	9J8153	P-UB-14	4-3/4	6	CTC-8T1908		142.04	
SLAVE STICK	9J4882	P-UB-10	4	5	CTC-7X2816		164.89	
	3G5646	P-UB-10	5	7-3/4	CTC-8T1479		235.32	
	6E5096	P-UB-10	5	7-3/4	CTC-3E8887		292.85	
	9T1387	P-UB-10	5	7-3/4	CTC-8T1479		235.32	
	9T9354	P-UB-10	5	7-3/4	CTC-3E8887		292.85	
MODEL 235C								
BOOM	1024211	P-UB-10	4-1/4	6-1/2	CTC-8T1461		148.40	
	4T1689	P-UB-10	4-1/4	6-1/2	CTC-8T1461		148.40	
	4T1921	P-UB-10	4-1/4	6-1/2	CTC-8T1461		148.40	
	6C5856	P-UB-10	4-1/4	6-1/2	CTC-8T1461		148.40	
	6C5857	P-UB-10	4-1/4	6-1/2	CTC-8T1461		148.40	
	6E1643	P-UB-14	4-3/4	7	CTC-8T1567		155.47	
	9T6615	P-UB-10	4-3/4	7	CTC-7X7734		282.69	
	9T6615	P-UB-14	4-3/4	7	CTC-8T1567		155.47	
	9T9360	P-UB-14	4-3/4	7	CTC-8T1567		155.47	
	9T9995	P-UB-10	4-1/4	6-1/2	CTC-8T1461		148.40	
	9T9995	P-UB-10	4-1/4	6-1/2	CTC-9X6379		206.99	
	BOTTOM DUMP BUCKET	4T0483	P-UB-14	3	7-1/4	CTC-7X2699		140.39
		1024216	P-UB-14	4-3/4	6-1/2	CTC-8T1462		131.90
SLAVE STICK	4T2536	P-UB-14	4-3/4	6-1/2	CTC-8T1462		131.90	
	9J8153	P-UB-14	4-3/4	6	CTC-8T1908		142.04	
	9J4882	P-UB-10	4	5	CTC-7X2816		164.89	
	3G5646	P-UB-10	5	7-3/4	CTC-8T1479		235.32	
	6E5096	P-UB-10	5	7-3/4	CTC-3E8887		292.85	
	9T1387	P-UB-10	5	7-3/4	CTC-8T1479		235.32	
	9T9354	P-UB-10	5	7-3/4	CTC-3E8887		292.85	
MODEL 235C FS								
BOOM	4T1689	P-UB-10	4-1/4	6-1/2	CTC-8T1461		148.40	
	9T6615	P-UB-10	4-3/4	7	CTC-7X7734		282.69	
BOTTOM DUMP BUCKET	4T0483	P-UB-14	3	7-1/4	CTC-7X2699		140.39	
	4T2536	P-UB-14	4-3/4	6-1/2	CTC-8T1462		131.90	
MASTER STICK	9J8153	P-UB-14	4-3/4	6	CTC-8T1908		142.04	
	9J4882	P-UB-10	4	5	CTC-7X2816		164.89	
	9T1387	P-UB-10	5	7-3/4	CTC-8T1479		235.32	
MODEL 235D								
BOOM	1024210	P-UB-10	4-1/4	6-1/2	CTC-8T1461		148.40	
	4T1689	P-UB-10	4-1/4	6-1/2	CTC-8T1461		148.40	
	6C5856	P-UB-10	4-1/4	6-1/2	CTC-8T1461		148.40	
	6C5857	P-UB-10	4-1/4	6-1/2	CTC-8T1461		148.40	
	6E1643	P-UB-14	4-3/4	7	CTC-8T1567		155.47	
	9T9995	P-UB-10	4-1/4	6-1/2	CTC-8T1461		148.40	
	9T9995	P-UB-10	4-1/4	6-1/2	CTC-9X6379		206.99	
BOTTOM DUMP BUCKET	4T0483	P-UB-14	3	7-1/4	CTC-7X2699		140.39	
	1024216	P-UB-14	4-3/4	6-1/2	CTC-8T1462		131.90	
SLAVE	4T2536	P-UB-14	4-3/4	6-1/2	CTC-8T1462		131.90	
	9J4882	P-UB-10	4	5	CTC-7X2816		164.89	

REPLACEMENT KITS FOR CATERPILLAR® EQUIPMENT

Excavators								
APPLICATION	CYL #	CODE	ROD	BORE	KIT #	Misc-Serial #'s, Parts, etc.	List \$	
MODEL 235D								
STICK	6E5096	P-UB-10	5	7-3/4	CTC-3E8887		292.85	
	9T9354	P-UB-10	5	7-3/4	CTC-3E8887		292.85	
TRACK ADJUSTER		TRK ADJ			CTC-FIG0405		64.64	
MODEL 245 FS								
BOOM	3G4615	P-UB-10	5	6	CTC-8T1909		220.24	
	9J5379	P-UB-14	4-3/4	7	CTC-8T1567		155.47	
BUCKET	1U1646	P-UB-14	4-3/4	7	CTC-8T1565		160.06	
	8J8721	P-UB-14	4-3/4	7	CTC-8T1565		160.06	
STICK	3G2778	P-UB-10	5-3/4	8-1/4	CTC-8T1558		403.06	
MODEL 245, 245B								
BOOM	1024212	P-UB-14	4-3/4	7	CTC-8T1567		155.47	
	3G3524	P-UB-14	4-3/4	7-1/4	CTC-8T1545		188.44	
	3G4615	P-UB-10	5	6	CTC-8T1909		220.24	
	8J3720	P-UB-14	4-3/4	7	CTC-8T1567		155.47	
	9J5379	P-UB-14	4-3/4	7	CTC-8T1567		155.47	
	9T9358	P-UB-14	4-3/4	7-1/4	CTC-8T1545		188.44	
BOTTOM DUMP BUCKET	1U1659	P-UB-10	3-1/2	7-3/4	CTC-9X2644		151.15	
	1U1646	P-UB-14	4-3/4	7	CTC-8T1565		160.06	
	1U1646	P-UB-14	4-3/4	7	CTC-8T1567		155.47	
	1U1659	P-UB-10	3-1/2	7-3/4	CTC-9X2644		151.15	
COUNTERWEIGHT LIFT	8J8721	P-U-10	4-3/4	7	CTC-1371946		238.73	
	8J8721	P-UB-14	4-3/4	7	CTC-8T1565		160.06	
	9J7755	P-UB-10	5-3/4	7	CTC-8C4398		232.69	
	9J9398	P-UB-10	5-3/4	7	CTC-8C4398		232.69	
	8J6167	P-UB-10	2-1/2	5	CTC-7X2658		113.62	
	8J6167	P-UB-10	2-1/2	5	CTC-1315118		116.00	
	8J6167	P-UB-10	2-1/2	5	CTC-7X2658		113.62	
	STICK	1011908	P-UB-10	5-3/4	8-1/4	CTC-3E8880		467.42
		3G2778	P-UB-10	5-3/4	8-1/4	CTC-3E8880		467.42
		3G2778	P-UB-10	5-3/4	8-1/4	CTC-8T1558		403.06
6E5093		P-UB-10	5-3/4	8-1/4	CTC-3E8880		467.42	
9T1388		P-UB-10	5-3/4	8-1/4	CTC-3E8880		467.42	
9T1388		P-UB-10	5-3/4	8-1/4	CTC-8T1558		403.06	
9T9356		P-UB-10	5-3/4	8-1/4	CTC-3E8880		467.42	
TRACK ADJUSTER		TRK ADJ			CTC-FIG0405		64.64	
MODEL 245B FS								
BOOM	3G3524	P-UB-14	4-3/4	7-1/4	CTC-8T1545		188.44	
	3G4615	P-UB-10	5	6	CTC-8T1909		220.24	
	9J5379	P-UB-14	4-3/4	7	CTC-8T1567		155.47	
BUCKET	1U1646	P-UB-14	4-3/4	7	CTC-8T1565		160.06	
	8J8721	P-UB-14	4-3/4	7	CTC-8T1565		160.06	
STICK	3G2778	P-UB-10	5-3/4	8-1/4	CTC-8T1558		403.06	
MODEL 245D								
BOOM	1024212	P-UB-14	4-3/4	7	CTC-8T1567		155.47	
	3G3524	P-UB-14	4-3/4	7-1/4	CTC-8T1545		188.44	
	8J3720	P-UB-14	4-3/4	7	CTC-8T1567		155.47	
	9J5379	P-UB-14	4-3/4	7	CTC-8T1567		155.47	
	9T9358	P-UB-14	4-3/4	7-1/4	CTC-8T1545		188.44	

REPLACEMENT KITS FOR CATERPILLAR® EQUIPMENT

Excavators							
APPLICATION	CYL #	CODE	ROD	BORE	KIT #	Misc-Serial #'s, Parts, etc.	List \$
MODEL 245D							
BOTTOM DUMP BUCKET	1U1659	P-UB-10	3-1/2	7-3/4	CTC-9X2644		151.15
	1U1646	P-UB-14	4-3/4	7	CTC-8T1565		160.06
LIFT	1U1646	P-UB-14	4-3/4	7	CTC-8T1567		155.47
	8J8721	P-U-10	4-3/4	7	CTC-1371946		238.73
	9J9398	P-UB-10	5-3/4	7	CTC-8C4398		232.69
	8J6167	P-UB-10	2-1/2	5	CTC-1315118		116.00
	8J6167	P-UB-10	2-1/2	5	CTC-7X2658		113.62
STICK	1011908	P-UB-10	5-3/4	8-1/4	CTC-3E8880		467.42
	3G2778	P-UB-10	5-3/4	8-1/4	CTC-3E8880		467.42
	6E5093	P-UB-10	5-3/4	8-1/4	CTC-3E8880		467.42
	9T1388	P-UB-10	5-3/4	8-1/4	CTC-3E8880		467.42
	9T1388	P-UB-10	5-3/4	8-1/4	CTC-8T1558		403.06
	9T9356	P-UB-10	5-3/4	8-1/4	CTC-3E8880		467.42
TRACK ADJUSTER		TRK ADJ			CTC-FIG0405		64.64
MODEL 307							
BLADE LH	1076377	P-UB-15	50 mm	90 mm	CTC-933045		188.47
	1148378	P-UB-15	50 mm	90 mm	CTC-933045		188.47
BLADE RH	1076472	P-UB-15	50 mm	90 mm	CTC-933045		188.47
	1148377	P-UB-15	50 mm	90 mm	CTC-933045		188.47
BOOM	1038195	P-UB-14	75 mm	110 mm	CTC-1057255		177.44
	1057468	P-UB-14	55 mm	100 mm	CTC-1057480		137.75
	1239937	P-UB-14	55 mm	100 mm	CTC-1057480		137.75
BUCKET	1057238	P-UB-14	55 mm	80 mm	CTC-1057253		120.44
OFFSET	1057468	P-UB-14	55 mm	100 mm	CTC-1057480		137.75
STICK	1239937	P-UB-14	55 mm	100 mm	CTC-1057480		137.75
	1038320	P-UB-14	60 mm	90 mm	CTC-1038333		161.60
	1057437	P-UB-14	60 mm	90 mm	CTC-1038333		161.60
	1251494	P-UB-14	60 mm	90 mm	CTC-1038333		161.60
MODEL 307B							
BLADE	1231627	P-UB-10	80 mm	120 mm	CTC-1697835		140.99
	1624835	P-UB-10	80 mm	120 mm	CTC-1697835		140.99
BUCKET	1057238	P-UB-14	55 mm	80 mm	CTC-1057253		120.44
OFFSET	1239937	P-UB-14	55 mm	100 mm	CTC-1057480		137.75
STICK	1038320	P-UB-14	60 mm	90 mm	CTC-1038333		161.60
MODEL 308B							
BLADE	1231627	P-UB-10	80 mm	120 mm	CTC-1697835		140.99
	1624835	P-UB-10	80 mm	120 mm	CTC-1697835		140.99
BUCKET	1057238	P-UB-14	55 mm	80 mm	CTC-1057253		120.44
STICK	1038320	P-UB-14	60 mm	90 mm	CTC-1038333		161.60
MODEL 311							
BUCKET	1251547	P-UB-10	65 mm	100 mm	CTC-418914		133.28
	1346987	P-UB-10	65 mm	100 mm	CTC-1764935		144.29
	418840	P-UB-10	65 mm	100 mm	CTC-418914		133.28
STICK	1251549	P-UB-10	75 mm	110 mm	CTC-418913		189.76
	418842	P-UB-10	75 mm	110 mm	CTC-418913		189.76
MODEL 311B							
BLADE LH	1298009	P-UB-10	80 mm	120 mm	CTC-1697835		140.99
BLADE RH	1298010	P-UB-10	80 mm	120 mm	CTC-1697835		140.99

REPLACEMENT KITS FOR CATERPILLAR® EQUIPMENT

Excavators							
APPLICATION	CYL #	CODE	ROD	BORE	KIT #	Misc-Serial #'s, Parts, etc.	List \$
MODEL 311B							
BUCKET	1195447	P-UB-10	65 mm	100 mm	CTC-1195457		139.88
	1438158	P-UB-10	65 mm	100 mm	CTC-1697839		142.83
STICK	1211406	P-UB-10	75 mm	110 mm	CTC-1195435		192.65
	1438160	P-UB-10	75 mm	110 mm	CTC-1697837		169.37
MODEL 312							
BOOM	1148519	P-UB-10	75 mm	110 mm	CTC-1148526		156.37
	1251545	P-UB-10	75 mm	110 mm	CTC-418913		189.76
	418838	P-UB-10	75 mm	110 mm	CTC-418913		189.76
BUCKET	1195447	P-UB-10	65 mm	100 mm	CTC-1195457		139.88
	1251547	P-UB-10	65 mm	100 mm	CTC-418914		133.28
	1346987	P-UB-10	65 mm	100 mm	CTC-1764935		144.29
	418840	P-UB-10	65 mm	100 mm	CTC-418914		133.28
OFFSET STICK	1239906	P-UB-10	70 mm	130 mm	CTC-1697843		191.64
	1211406	P-UB-10	75 mm	110 mm	CTC-1195435		192.65
	1239943	P-UB-10	80 mm	120 mm	CTC-1148290		132.33
	1251546	P-UB-10	80 mm	120 mm	CTC-513047		159.66
	1251940	P-UB-10	80 mm	120 mm	CTC-1148290		132.33
418839	P-UB-10	80 mm	120 mm	CTC-513047		159.66	
MODEL 312B, 312BL							
BLADE LH	1298009	P-UB-10	80 mm	120 mm	CTC-1697835		140.99
BLADE RH	1298010	P-UB-10	80 mm	120 mm	CTC-1697835		140.99
BOOM	1195425	P-UB-10	75 mm	110 mm	CTC-1195435		192.65
	1438156	P-UB-10	75 mm	110 mm	CTC-1697837		169.37
BUCKET	1195447	P-UB-10	65 mm	100 mm	CTC-1195457		139.88
	1438158	P-UB-10	65 mm	100 mm	CTC-1697839		142.83
STICK	1195436	P-UB-10	80 mm	120 mm	CTC-1195446		175.75
	1438157	P-UB-10	80 mm	120 mm	CTC-1697838		176.92
MODEL 313B							
BLADE LH	1298009	P-UB-10	80 mm	120 mm	CTC-1697835		140.99
BLADE RH	1298010	P-UB-10	80 mm	120 mm	CTC-1697835		140.99
BOOM	1624758	P-UB-10	75 mm	110 mm	CTC-1697837		169.37
BUCKET	1346987	P-UB-10	65 mm	100 mm	CTC-1764935		144.29
	1438158	P-UB-10	65 mm	100 mm	CTC-1697839		142.83
OFFSET STICK	1239906	P-UB-10	70 mm	130 mm	CTC-1697843		191.64
STICK	1195436	P-UB-10	80 mm	120 mm	CTC-1195446		175.75
	1211406	P-UB-10	75 mm	110 mm	CTC-1195435		192.65
	1438157	P-UB-10	80 mm	120 mm	CTC-1697838		176.92
	1438160	P-UB-10	75 mm	110 mm	CTC-1697837		169.37
MODEL 315, 317							
BOOM	1057336	P-UB-10	80 mm	110 mm	CTC-1057359		159.85
	1276046	P-UB-10	80 mm	110 mm	CTC-1057359		159.85
BUCKET	1057381	P-UB-10	70 mm	100 mm	CTC-1057397		132.22
	1076640	P-UB-10	80 mm	110 mm	CTC-1057359		159.85
	1276056	P-UB-10	70 mm	100 mm	CTC-1057397		132.22
	1276060	P-UB-10	80 mm	110 mm	CTC-1057359		159.85
STICK	1057362	P-UB-10	85 mm	120 mm	CTC-1057379		169.01
	1276051	P-UB-10	85 mm	120 mm	CTC-1057379		169.01

REPLACEMENT KITS FOR CATERPILLAR® EQUIPMENT

Excavators								
APPLICATION	CYL #	CODE	ROD	BORE	KIT #	Misc-Serial #'s, Parts, etc.	List \$	
MODEL 315B, 315BL, 317B, 317BL								
BOOM	1336630	P-UB-10	80 mm	110 mm	CTC-1336646		120.78	
BUCKET	1336636	P-UB-10	70 mm	100 mm	CTC-1336691		140.26	
	1336639	P-UB-10	80 mm	110 mm	CTC-1336646		120.78	
STICK	1336633	P-UB-10	85 mm	120 mm	CTC-1184131		162.94	
MODEL 315L, 317N								
BOOM	1057336	P-UB-10	80 mm	110 mm	CTC-1057359		159.85	
BUCKET	1057381	P-UB-10	70 mm	100 mm	CTC-1057397		132.22	
	1076640	P-UB-10	80 mm	110 mm	CTC-1057359		159.85	
STICK	1057362	P-UB-10	85 mm	120 mm	CTC-1057379		169.01	
MODEL 318B, 318BL								
BOOM	1475755	P-UB-10	85 mm	120 mm	CTC-1373763		241.13	
BUCKET	1183967	P-UB-10	85 mm	120 mm	CTC-1261947		225.71	
	1184134	P-UB-10	85 mm	120 mm	CTC-1184131		162.94	
MODEL 320								
BOOM	0874898	P-UB-10	100 mm	140 mm	CTC-1270630		221.81	
	0875491	P-UB-10	85 mm	120 mm	CTC-413665		204.12	
	0875496	P-UB-10	85 mm	120 mm	CTC-0875394		168.75	
	0875496	P-UB-10	85 mm	120 mm	CTC-1184131		162.94	
BOOM VA	1069596	P-UB-10	95 mm	160 mm	CTC-6C6091		219.64	
	6C6085	P-UB-10	95 mm	160 mm	CTC-6C6091		219.64	
BUCKET	0874899	P-UB-10	85 mm	120 mm	CTC-1186023		173.68	
	0875633	P-UB-10	85 mm	120 mm	CTC-0875394		168.75	
	0875633	P-UB-10	85 mm	120 mm	CTC-1184131		162.94	
	1185931	P-UB-10	85 mm	120 mm	CTC-1186023		173.68	
	1251547	P-UB-10	65 mm	100 mm	CTC-418914		133.28	
	1346987	P-UB-10	65 mm	100 mm	CTC-1764935		144.29	
	417652	P-UB-10	65 mm	100 mm	CTC-417664		133.33	
	418840	P-UB-10	65 mm	100 mm	CTC-418914		133.28	
	717291	P-UB-10	85 mm	130 mm	CTC-7Y5145		174.28	
	7Y5100	P-UB-10	85 mm	130 mm	CTC-7Y5145		174.28	
	STICK	0875422	P-UB-10	100 mm	140 mm	CTC-0875387		222.80
		0875493	P-UB-10	100 mm	140 mm	CTC-1270630		221.81
		0876638	P-UB-10	100 mm	140 mm	CTC-0875387		222.80
7Y4650		P-UB-10	105 mm	150 mm	CTC-1163612		196.76	
MODEL 320B, 320BL								
BOOM	1183953	P-UB-10	100 mm	140 mm	CTC-1373764		210.45	
	1183955	P-UB-10	100 mm	140 mm	CTC-1373764		210.45	
	1184023	P-UB-10	85 mm	120 mm	CTC-1373763		241.13	
	1184128	P-UB-10	85 mm	120 mm	CTC-1184131		162.94	
	1195425	P-UB-10	75 mm	110 mm	CTC-1195435		192.65	
	1232081	P-UB-10	105 mm	150 mm	CTC-1373767		273.11	
	1336770	P-UB-10	100 mm	140 mm	CTC-1336823		209.41	
BUCKET	1183967	P-UB-10	85 mm	120 mm	CTC-1261947		225.71	
	1184134	P-UB-10	85 mm	120 mm	CTC-1184131		162.94	
	1195447	P-UB-10	65 mm	100 mm	CTC-1195457		139.88	
	1232044	P-UB-10	90 mm	130 mm	CTC-1184175		192.54	
	1232084	P-UB-10	90 mm	130 mm	CTC-1373768		287.23	
	1251547	P-UB-10	65 mm	100 mm	CTC-418914		133.28	

REPLACEMENT KITS FOR CATERPILLAR® EQUIPMENT

Excavators							
APPLICATION	CYL #	CODE	ROD	BORE	KIT #	Misc-Serial #'s, Parts, etc.	List \$
MODEL 320B, 320BL							
BUCKET N/A	1346987	P-UB-10	65 mm	100 mm	CTC-1764935		144.29
	1475780	P-UB-10	85 mm	125 mm	CTC-1475781		187.55
	1540756	P-UB-10	90 mm	130 mm	CTC-1540757		292.39
	4I7652	P-UB-10	65 mm	100 mm	CTC-4I7664		133.33
	4I8840	P-UB-10	65 mm	100 mm	CTC-4I8914		133.28
	1336771	P-UB-10	105 mm	150 mm	CTC-1373767		273.11
	1336812	P-UB-10	90 mm	130 mm	CTC-1373768		287.23
	1540727	P-UB-10	85mm	120mm	CTC-1540728		318.06
	1540743	P-UB-10	85mm	120mm	CTC-1540744		305.88
	1540772	P-UB-10	90 mm	130 mm	CTC-1540773		292.19
STICK	1184000	P-UB-10	105 mm	150 mm	CTC-1680758		227.58
	1232081	P-UB-10	105 mm	150 mm	CTC-1373767		273.11
TILT CAB	N/A	P-UB-10	2-1/4	5	CTC-9X6392		104.34
MODEL 320L							
BOOM	874898	P-UB-10	100 mm	140 mm	CTC-1270630		221.81
BUCKET	1251547	P-UB-10	65 mm	100 mm	CTC-4I8914		133.28
	4I7652	P-UB-10	65 mm	100 mm	CTC-4I7664		133.33
	4I8840	P-UB-10	65 mm	100 mm	CTC-4I8914		133.28
	7I7291	P-UB-10	85 mm	130 mm	CTC-7Y5145		174.28
	7Y5100	P-UB-10	85 mm	130 mm	CTC-7Y5145		174.28
STICK	7Y4650	P-UB-10	105 mm	150 mm	CTC-1163612		196.76
	875493	P-UB-10	100 mm	140 mm	CTC-1270630		221.81
MODEL 320N							
BOOM	874898	P-UB-10	100 mm	140 mm	CTC-1270630		221.81
BUCKET	7Y5100	P-UB-10	85 mm	130 mm	CTC-7Y5145		174.28
STICK	875493	P-UB-10	100 mm	140 mm	CTC-1270630		221.81
MODEL 320S							
BOOM	0875496	P-UB-10	85 mm	120 mm	CTC-1184131		162.94
	1069596	P-UB-10	95 mm	160 mm	CTC-6C6091		219.64
BUCKET	0875633	P-UB-10	85 mm	120 mm	CTC-1184131		162.94
	7Y5100	P-UB-10	85 mm	130 mm	CTC-7Y5145		174.28
N/A	6C6085	P-UB-10	95 mm	160 mm	CTC-6C6091		219.64
STICK	0875422	P-UB-10	100 mm	140 mm	CTC-0875387		222.80
	0876638	P-UB-10	100 mm	140 mm	CTC-0875387		222.80
MODEL 321B							
BUCKET	1232084	P-UB-10	90 mm	130 mm	CTC-1373768		287.23
N/A	1183967	P-UB-10	85 mm	120 mm	CTC-1261947		225.71
MODEL 322							
BOOM	1052571	P-UB-10	90 mm	130 mm	CTC-1052585		315.66
	1052588	P-UB-10	100 mm	140 mm	CTC-1270630		221.81
BUCKET	7I1345	P-UB-10	90 mm	130 mm	CTC-7I1360		193.43
	0875633	P-UB-10	85 mm	120 mm	CTC-0875394		168.75
	0875633	P-UB-10	85 mm	120 mm	CTC-1184131		162.94
	1052597	P-UB-10	85 mm	130 mm	CTC-1052601		282.60
	1185931	P-UB-10	85 mm	120 mm	CTC-1186023		173.68
	4I8840	P-UB-10	65 mm	100 mm	CTC-4I8914		133.28
	7I7291	P-UB-10	85 mm	130 mm	CTC-7Y5145		174.28
	7Y5100	P-UB-10	85 mm	130 mm	CTC-7Y5145		174.28

REPLACEMENT KITS FOR CATERPILLAR® EQUIPMENT

CATERPILLAR®

Excavators							
APPLICATION	CYL #	CODE	ROD	BORE	KIT #	Misc-Serial #'s, Parts, etc.	List \$
MODEL 322							
BUCKET	7Y5150	P-UB-10	105 mm	150 mm	CTC-1163612		196.76
STICK	7I7341	P-UB-10	100 mm	140 mm	CTC-0875387		222.80
MODEL 322B, 322BL							
BOOM	1140636	P-UB-10	100 mm	140 mm	CTC-1184024		212.25
	1184069	P-UB-10	90 mm	130 mm	CTC-1373765		310.39
	1184070	P-UB-10	100 mm	140 mm	CTC-1373764		210.45
	1184166	P-UB-10	90 mm	130 mm	CTC-1184175		192.54
	1336869	P-UB-10	90 mm	130 mm	CTC-1540748		187.87
BUCKET	1183921	P-UB-10	105 mm	150 mm	CTC-1163612		196.76
	1183921	P-UB-10	105 mm	150 mm	CTC-1680758		227.58
	1184008	P-UB-10	90 mm	130 mm	CTC-1184175		192.54
	1184134	P-UB-10	85 mm	120 mm	CTC-1184131		162.94
	1232044	P-UB-10	90 mm	130 mm	CTC-1184175		192.54
	1232084	P-UB-10	90 mm	130 mm	CTC-1373768		287.23
	1232091	P-UB-10	90 mm	130 mm	CTC-1261887		278.89
	1251547	P-UB-10	65 mm	100 mm	CTC-418914		133.28
	1336810	P-UB-10	105 mm	150 mm	CTC-1289277		239.94
	1346987	P-UB-10	65 mm	100 mm	CTC-1764935		144.29
	1540756	P-UB-10	90 mm	130 mm	CTC-1540757		292.39
	4I1726	P-UB-10	110 mm	160 mm	CTC-0876654		209.30
	4I8840	P-UB-10	65 mm	100 mm	CTC-418914		133.28
N/A	1183967	P-UB-10	85 mm	120 mm	CTC-1261947		225.71
	1540743	P-UB-10	85mm	120mm	CTC-1540744		305.88
	1540747	P-UB-10	90 mm	130 mm	CTC-1540748		187.87
STICK	1163638	P-UB-10	110 mm	170 mm	CTC-1163649		245.59
	1163638	P-UB-10	110 mm	170 mm	CTC-1680759		261.31
	1183953	P-UB-10	100 mm	140 mm	CTC-1373764		210.45
	1184000	P-UB-10	105 mm	150 mm	CTC-1163612		196.76
	1184000	P-UB-10	105 mm	150 mm	CTC-1680758		227.58
	1184176	P-UB-10	100 mm	140 mm	CTC-1184024		212.25
	1336771	P-UB-10	105 mm	150 mm	CTC-1373767		273.11
	7Y4650	P-UB-10	105 mm	150 mm	CTC-7Y4698		219.26
TILT CAB	N/A	P-UB-10	2-1/4	5	CTC-9X6392		104.34
MODEL 322L							
BOOM	1052571	P-UB-10	90 mm	130 mm	CTC-1052585		315.66
	1052588	P-UB-10	100 mm	140 mm	CTC-1270630		221.81
	7I1345	P-UB-10	90 mm	130 mm	CTC-7I1360		193.43
BUCKET	1052597	P-UB-10	85 mm	130 mm	CTC-1052601		282.60
	7I7291	P-UB-10	85 mm	130 mm	CTC-7Y5145		174.28
	7Y5100	P-UB-10	85 mm	130 mm	CTC-7Y5145		174.28
	7Y5150	P-UB-10	105 mm	150 mm	CTC-1163612		196.76
	875633	P-UB-10	85 mm	120 mm	CTC-0875394		168.75
STICK	7I7341	P-UB-10	100 mm	140 mm	CTC-0875387		222.80
MODEL 322N							
BOOM	7I1345	P-UB-10	90 mm	130 mm	CTC-7I1360		193.43
BUCKET	7I7291	P-UB-10	85 mm	130 mm	CTC-7Y5145		174.28
	7Y5100	P-UB-10	85 mm	130 mm	CTC-7Y5145		174.28
	7Y5150	P-UB-10	105 mm	150 mm	CTC-1163612		196.76

REPLACEMENT KITS FOR CATERPILLAR® EQUIPMENT

Excavators								
APPLICATION	CYL #	CODE	ROD	BORE	KIT #	Misc-Serial #'s, Parts, etc.	List \$	
MODEL 322N								
STICK	717341	P-UB-10	100 mm	140 mm	CTC-0875387		222.80	
MODEL 325								
BOOM	7Y4601	P-UB-10	95 mm	130 mm	CTC-7Y5147		194.91	
BUCKET	0875491	P-UB-10	85 mm	120 mm	CTC-4I3665		204.12	
	0875633	P-UB-10	85 mm	120 mm	CTC-0875394		168.75	
	0875633	P-UB-10	85 mm	120 mm	CTC-1184131		162.94	
	1072614	P-UB-10	85 mm	130 mm	CTC-7Y5145		174.28	
	1346987	P-UB-10	65 mm	100 mm	CTC-1764935		144.29	
	4I7652	P-UB-10	65 mm	100 mm	CTC-4I7664		133.33	
	4I8840	P-UB-10	65 mm	100 mm	CTC-4I8914		133.28	
	7I7291	P-UB-10	85 mm	130 mm	CTC-7Y5145		174.28	
	7Y5100	P-UB-10	85 mm	130 mm	CTC-7Y5145		174.28	
	7Y5150	P-UB-10	105 mm	150 mm	CTC-1163612		196.76	
STICK	7Y4650	P-UB-10	105 mm	150 mm	CTC-1163612		196.76	
	7Y4926	P-UB-10	110 mm	170 mm	CTC-1163649		245.59	
MODEL 325B, 325BL								
BOOM	1077040	P-UB-10	100 mm	140 mm	CTC-1373766		202.02	
	1140636	P-UB-10	100 mm	140 mm	CTC-1184024		212.25	
	1169123	P-UB-10	105 mm	150 mm	CTC-1163612		196.76	
	1232081	P-UB-10	105 mm	150 mm	CTC-1373767		273.11	
	1540760	P-UB-10	100 mm	140 mm	CTC-1540761		249.26	
BUCKET	1183921	P-UB-10	105 mm	150 mm	CTC-1163612		196.76	
	1183921	P-UB-10	105 mm	150 mm	CTC-1680758		227.58	
	1184134	P-UB-10	85 mm	120 mm	CTC-1184131		162.94	
	1232044	P-UB-10	90 mm	130 mm	CTC-1184175		192.54	
	1232084	P-UB-10	90 mm	130 mm	CTC-1373768		287.23	
	1336810	P-UB-10	105 mm	150 mm	CTC-1289277		239.94	
	1497610	P-UB-10	90 mm	130 mm	CTC-1184175		192.54	
	1540756	P-UB-10	90 mm	130 mm	CTC-1540757		292.39	
	1540772	P-UB-10	90 mm	130 mm	CTC-1540773		292.19	
	4I1726	P-UB-10	110 mm	160 mm	CTC-0876654		209.30	
	4I7652	P-UB-10	65 mm	100 mm	CTC-4I7664		133.33	
	4I8840	P-UB-10	65 mm	100 mm	CTC-4I8914		133.28	
	STICK	0875375	P-UB-10	130 mm	180 mm	CTC-0875407		259.62
		1163638	P-UB-10	110 mm	170 mm	CTC-1163649		245.59
		1184000	P-UB-10	105 mm	150 mm	CTC-1163612		196.76
1184000		P-UB-10	105 mm	150 mm	CTC-1680758		227.58	
1232081		P-UB-10	105 mm	150 mm	CTC-1373767		273.11	
1479427		P-UB-10	105 mm	150 mm	CTC-1680758		227.58	
1540765		P-UB-10	105 mm	150 mm	CTC-1540766		255.91	
7Y4650		P-UB-10	105 mm	150 mm	CTC-7Y4698		219.26	
MODEL 325L								
BOOM		7Y4601	P-UB-10	95 mm	130 mm	CTC-7Y5147		194.91
BUCKET	1251547	P-UB-10	65 mm	100 mm	CTC-4I8914		133.28	
	4I7652	P-UB-10	65 mm	100 mm	CTC-4I7664		133.33	
	4I8840	P-UB-10	65 mm	100 mm	CTC-4I8914		133.28	
	7I7291	P-UB-10	85 mm	130 mm	CTC-7Y5145		174.28	
	7Y5100	P-UB-10	85 mm	130 mm	CTC-7Y5145		174.28	

REPLACEMENT KITS FOR CATERPILLAR® EQUIPMENT

Excavators							
APPLICATION	CYL #	CODE	ROD	BORE	KIT #	Misc-Serial #'s, Parts, etc.	List \$
MODEL 325L							
BUCKET	7Y5150	P-UB-10	105 mm	150 mm	CTC-1163612		196.76
	875633	P-UB-10	85 mm	120 mm	CTC-0875394		168.75
STICK	1169123	P-UB-10	105 mm	150 mm	CTC-1163612		196.76
	7Y4650	P-UB-10	105 mm	150 mm	CTC-1163612		196.76
MODEL 325N							
BOOM	7Y4601	P-UB-10	95 mm	130 mm	CTC-7Y5147		194.91
BUCKET	7Y5100	P-UB-10	85 mm	130 mm	CTC-7Y5145		174.28
	7Y5150	P-UB-10	105 mm	150 mm	CTC-1163612		196.76
	875633	P-UB-10	85 mm	120 mm	CTC-0875394		168.75
STICK	7Y4650	P-UB-10	105 mm	150 mm	CTC-1163612		196.76
MODEL 330							
BOOM	7Y4906	P-UB-10	105 mm	150 mm	CTC-1163612		196.76
BUCKET	0875531	P-UB-10	110 mm	160 mm	CTC-0876654		209.30
	0875633	P-UB-10	85 mm	120 mm	CTC-0875394		168.75
	7Y5100	P-UB-10	85 mm	130 mm	CTC-7Y5145		174.28
	7Y5150	P-UB-10	105 mm	150 mm	CTC-1163612		196.76
	7Y4926	P-UB-10	110 mm	170 mm	CTC-1163649		245.59
STICK	7Y4926	P-UB-10	110 mm	170 mm	CTC-1163649		245.59
MODEL 330B, 330BL							
BOOM	1163578	P-UB-10	105 mm	150 mm	CTC-1680758		227.58
	1336808	P-UB-10	105 mm	150 mm	CTC-1289277		239.94
BUCKET	1183921	P-UB-10	105 mm	150 mm	CTC-1680758		227.58
	1183935	P-UB-10	110	160	CTC-1680760		253.48
	1184134	P-UB-10	85 mm	120 mm	CTC-1184131		162.94
	1336810	P-UB-10	105 mm	150 mm	CTC-1289277		239.94
	1336811	P-UB-10	110 mm	160 mm	CTC-1289280		251.28
STICK	0875375	P-UB-10	130 mm	180 mm	CTC-0875407		259.62
	1163638	P-UB-10	110 mm	170 mm	CTC-1680759		261.31
	1336809	P-UB-10	110 mm	170 mm	CTC-1289278		259.07
MODEL 330L							
BOOM	7Y4906	P-UB-10	105 mm	150 mm	CTC-1163612		196.76
BUCKET	1183921	P-UB-10	105 mm	150 mm	CTC-1163612		196.76
	1183935	P-UB-10	110 mm	160 mm	CTC-1183946		237.82
	411726	P-UB-10	110 mm	160 mm	CTC-0876654		209.30
	7Y5100	P-UB-10	85 mm	130 mm	CTC-7Y5145		174.28
	7Y5150	P-UB-10	105 mm	150 mm	CTC-1163612		196.76
	875531	P-UB-10	110 mm	160 mm	CTC-0876654		209.30
STICK	1163638	P-UB-10	110 mm	170 mm	CTC-1163649		245.59
	7Y4926	P-UB-10	110 mm	170 mm	CTC-1163649		245.59
TILT	1163578	P-UB-10	105 mm	150 mm	CTC-1163612		196.76
MODEL 345B, 345BL							
BOOM	1297829	P-UB-10	110	160	CTC-1680760		253.48
	1553737	P-UB-10	110	160	CTC-1680760		253.48
BUCKET	1183935	P-UB-10	110	160	CTC-1680760		253.48
	1184134	P-UB-10	85 mm	120 mm	CTC-1184131		162.94
	1232044	P-UB-10	90 mm	130 mm	CTC-1184175		192.54
	1297835	P-UB-10	110 mm	170 mm	CTC-1680759		261.31
	COUNTERWEIGHT	1231078	P-UB-10	3	4-3/4	CTC-1570288	
MATERIAL HANDLER	1504125	P-UB-10	110 mm	170 mm	CTC-1680759		261.31

REPLACEMENT KITS FOR CATERPILLAR® EQUIPMENT

Excavators							
APPLICATION	CYL #	CODE	ROD	BORE	KIT #	Misc-Serial #'s, Parts, etc.	List \$
MODEL 345B, 345BL							
STEERING	1151371	P-UB-10	2-1/4	4	CTC-1546526		98.29
STICK	1163638	P-UB-10	110 mm	170 mm	CTC-1680759		261.31
	1297832	P-UB-10	130 mm	190 mm	CTC-1261979		191.93
MODEL 350, 350L							
BOOM	411515	P-UB-10	110 mm	170 mm	CTC-1163649		245.59
	411515	P-UB-10	110 mm	170 mm	CTC-1680759		261.31
BUCKET	411726	P-UB-10	110 mm	160 mm	CTC-0876654		209.30
	413792	P-UB-10	130 mm	180 mm	CTC-0875407		259.62
	7Y5100	P-UB-10	85 mm	130 mm	CTC-7Y5145		174.28
LIFT	6E3529	P-UB-10	2-1/2	4	CTC-710968		94.28
STICK	0875375	P-UB-10	130 mm	180 mm	CTC-0875407		259.62
MODEL 365, 365B							
COUNTERWEIGHT	1505913	P-UB-10	90 mm	130 mm	CTC-1184175		192.54
MODEL 375							
BOOM	1140596	P-UB-10	140 mm	200 mm	CTC-1560626		334.71
	6E0018	P-UB-10	140 mm	200 mm	CTC-1560626		334.71
BUCKET	6E0020	P-UB-10	150 mm	220 mm	CTC-518893		521.05
	6E0021	P-UB-10	140 mm	200 mm	CTC-1560626		334.71
LIFT	6E3529	P-UB-10	2-1/2	4	CTC-710968		94.28
STICK	6E0019	P-UB-10	150 mm	220 mm	CTC-518893		521.05
MODEL 375L							
BOOM	6E0018	P-UB-10	140 mm	200 mm	CTC-1560626		334.71
BUCKET	411726	P-UB-10	110 mm	160 mm	CTC-0876654		209.30
LIFT	6E3529	P-UB-10	2-1/2	4	CTC-710968		94.28
STICK	6E0019	P-UB-10	150 mm	220 mm	CTC-518893		521.05
MODEL E110							
BOOM	0936151	P-UB-15	70 mm	110 mm	CTC-938385		138.51
BUCKET	0936181	P-UB-15	65 mm	110 mm	CTC-938390		220.68
STICK	0936167	P-UB-15	80 mm	120 mm	CTC-938388		225.04
MODEL E110B							
BOOM	0995402	P-UB-14	70 mm	100 mm	CTC-0995401		151.39
	0995403	P-UB-14	70 mm	100 mm	CTC-0995401		151.39
STICK	0855801	P-UB-14	75 mm	110 mm	CTC-995310		177.28
	0856657	P-UB-14	75 mm	100 mm	CTC-0860174		176.25
	0861937	P-UB-14	75 mm	110 mm	CTC-995310		177.28
	0995369	P-UB-14	75 mm	110 mm	CTC-995310		177.28
MODEL E120							
BOOM LH	0958487	P-UB-10	75 mm	110 mm	CTC-0967786		230.29
BOOM RH	0958486	P-UB-10	75 mm	110 mm	CTC-0967786		230.29
BUCKET	0938997	P-UB-10	65 mm	100 mm	CTC-0967625		219.85
STICK	0938966	P-UB-10	80 mm	120 mm	CTC-967799		221.94
MODEL E120B							
BOOM LH	0990662	P-UB-14	75 mm	110 mm	CTC-995310		177.28
BOOM RH	0990663	P-UB-14	75 mm	110 mm	CTC-995310		177.28
BUCKET	0990701	P-UB-14	65 mm	100 mm	CTC-995312		192.16
STICK	0855740	P-UB-14	80 mm	120 mm	CTC-995311	7NF03530-	189.21
	0861868	P-UB-14	80 mm	120 mm	CTC-995311	7NF01890-03529	189.21
	0990682	P-UB-14	80 mm	120 mm	CTC-995311	7NF1-01889	189.21

REPLACEMENT KITS FOR CATERPILLAR® EQUIPMENT

CATERPILLAR®

Excavators							
APPLICATION	CYL #	CODE	ROD	BORE	KIT #	Misc-Serial #'s, Parts, etc.	List \$
MODEL E120B							
TELESCOPIC STICK	0856657	P-UB-14	75 mm	100 mm	CTC-0860174		176.25
MODEL E180, EL180							
BOOM LH	0941911	P-UB-10	85 mm	125 mm	CTC-940691		210.47
BOOM RH	0941926	P-UB-10	85 mm	125 mm	CTC-940691		210.47
BUCKET	0941946	P-UB-10	85 mm	125 mm	CTC-940691		210.47
STICK	0941929	P-UB-10	100 mm	140 mm	CTC-941910		251.22
MODEL E200B, EL200B							
BOOM LH	0967907	P-UB-10	85 mm	120 mm	CTC-964395		253.63
BOOM RH	0967908	P-UB-10	85 mm	120 mm	CTC-964395		253.63
BUCKET	0967909	P-UB-10	75 mm	115 mm	CTC-966457		235.21
BUCKET LONG REACH	0993713	P-UB-14	65 mm	100 mm	CTC-995312		192.16
STICK	0967910	P-UB-10	95 mm	130 mm	CTC-965606		279.84
STICK LONG REACH	0993688	P-UB-10	95 mm	130 mm	CTC-965606		279.84
MODEL E240, EL240							
BOOM LH	0941549	P-UB-14	90 mm	140 mm	CTC-939941		199.62
BOOM RH	0941550	P-UB-14	90 mm	140 mm	CTC-939941		199.62
BUCKET	0962391	P-UB-14	90 mm	140 mm	CTC-939941		199.62
STICK	0941406	P-UB-14	100 mm	150 mm	CTC-942697		166.95
MODEL E240B, EL240B							
BOOM	1R8082	P-UB-14	90 mm	140 mm	CTC-939941		199.62
BOOM LH	0996240	P-UB-14	90 mm	140 mm	CTC-939941		199.62
BOOM RH	0996241	P-UB-14	90 mm	140 mm	CTC-939941		199.62
BUCKET	0996233	P-UB-14	90 mm	140 mm	CTC-939941		199.62
	1R5580	P-UB-14	65 mm	100 mm	CTC-995312		192.16
STICK	0996237	P-UB-14	100 mm	150 mm	CTC-942697		166.95
MODEL E300, EL300							
BOOM LH	0946493	P-UB-14	100 mm	150 mm	CTC-942697		166.95
BOOM RH	0946494	P-UB-14	100 mm	150 mm	CTC-942697		166.95
BUCKET	0962932	P-UB-14	100 mm	150 mm	CTC-942697		166.95
STICK	0962920	P-UB-14	110 mm	160 mm	CTC-942698		254.16
MODEL E300B, EL300B							
BOOM	1R7823	P-UB-10	95 mm	130 mm	CTC-965606		279.84
BOOM LH	0995577	P-UB-10	95 mm	130 mm	CTC-965606		279.84
BOOM RH	0995578	P-UB-10	95 mm	130 mm	CTC-965606		279.84
MODEL M320							
BOOM	1283203	P-UB-10	95 mm	130 mm	CTC-7Y5147		194.91
BUCKET	0875633	P-UB-10	85 mm	120 mm	CTC-0875394		168.75
	0875633	P-UB-10	85 mm	120 mm	CTC-1184131		162.94
STICK	1279242	P-UB-10	100 mm	140 mm	CTC-0875387		222.80
	1386696	P-UB-10	85 mm	120 mm	CTC-1184131		162.94
Front-Shovel Excavators							
APPLICATION	CYL #	CODE	ROD	BORE	KIT #	Misc-Serial #'s, Parts, etc.	List \$
MODEL 5080							
BOOM	4I3915	P-UB-10	130 mm	180 mm	CTC-0875407		259.62
STICK	6E4272	P-UB-10	150 mm	220 mm	CTC-518893		521.05
MODEL 5110							
BUCKET	6E0020	P-UB-10	150 mm	220 mm	CTC-518893		521.05

REPLACEMENT KITS FOR CATERPILLAR® EQUIPMENT

Front-Shovel Excavators							
APPLICATION	CYL #	CODE	ROD	BORE	KIT #	Misc-Serial #'s, Parts, etc.	List \$
MODEL 5230, 5230B							
BUCKET	6E6435	P-UB-10	3-1/2	7-1/4	CTC-1309483		189.24
Integrated Toolcarriers							
APPLICATION	CYL #	CODE	ROD	BORE	KIT #	Misc-Serial #'s, Parts, etc.	List \$
MODEL IT12							
LIFT	4T8579	I-U-3	3/4	1-1/4	CTC-1791715		9.84
	4T8580	P-UB-10	2	3-3/4	CTC-7X2787		58.89
M.P. BUCKET	8J5391	P-UB-10	1-1/2	3-1/2	CTC-7X2752		62.21
STEERING	1U4666	P-UB-10	1-1/2	2-3/4	CTC-7X2736		82.41
	9T5153	P-UB-10	1-1/2	2-3/4	CTC-7X2736		82.41
	9T5729	I-O-3	3/4	1-1/4	CTC-1791749		3.50
TILT	4T8581	P-UB-10	1-3/4	3-1/4	CTC-7X2764		41.63
	9T5151	P-UB-10	2	3-1/2	CTC-7X2783		67.15
	9T5489	P-UB-10	1-3/4	3-1/4	CTC-7X2764		41.63
MODEL IT12B							
LIFT	6E6398	P-UB-10	2-1/4	3-1/2	CTC-1859503		89.68
	9T5152	P-UB-10	2-1/4	4	CTC-1859527		74.75
PIN PULLER	9T5729	I-O-3	3/4	1-1/4	CTC-1791749		3.50
STEERING	4T8579	I-U-3	3/4	1-1/4	CTC-1791715		9.84
	9T5729	I-O-3	3/4	1-1/4	CTC-1791749		3.50
	9T7209	P-UB-10	1-1/2	2-3/4	CTC-1361599	HEAD# 6E4940	69.45
	9T7209	P-UB-10	1-1/2	2-3/4	CTC-7X2736	HEAD# 9T2542	82.41
	9T7210	P-UB-10	1-1/2	2-3/4	CTC-1361599	HEAD# 6E4940	69.45
	9T7210	P-UB-10	1-1/2	2-3/4	CTC-7X2736	HEAD# 9T2542	82.41
STEERING LH	6E5900	P-UB-10	1-3/4	2-3/4	CTC-1539053	HEAD# 1515349	98.31
	6E5900	P-UB-10	1-3/4	2-3/4	CTC-1857024	HEAD# 6E4941	35.89
	6E5973	P-UB-10	1-1/2	2-3/4	CTC-1361599		69.45
	9T7209	P-UB-10	1-1/2	2-3/4	CTC-1361599	HEAD# 6E4940	69.45
	9T7209	P-UB-10	1-1/2	2-3/4	CTC-7X2736	HEAD# 9T2542	82.41
STEERING RH	6E5972	P-UB-10	1-3/4	2-3/4	CTC-1539053	HEAD# 1515349	98.31
	6E5972	P-UB-10	1-3/4	2-3/4	CTC-1857024	HEAD# 6E4941	35.89
	6E5985	P-UB-10	1-1/2	2-3/4	CTC-1361599		69.45
TILT	9T5151	P-UB-10	2	3-1/2	CTC-1857674		75.33
MODEL IT12F							
LIFT	6E6398	P-UB-10	2-1/4	3-1/2	CTC-1859503		89.68
	9T5152	P-UB-10	2-1/4	4	CTC-1859527		74.75
STEERING	4T8579	I-U-3	3/4	1-1/4	CTC-1791715		9.84
	9T5729	I-O-3	3/4	1-1/4	CTC-1791749		3.50
	9T7209	P-UB-10	1-1/2	2-3/4	CTC-1361599	HEAD# 6E4940	69.45
	9T7209	P-UB-10	1-1/2	2-3/4	CTC-7X2736	HEAD# 9T2542	82.41
	9T7210	P-UB-10	1-1/2	2-3/4	CTC-1361599	HEAD# 6E4940	69.45
	9T7210	P-UB-10	1-1/2	2-3/4	CTC-7X2736	HEAD# 9T2542	82.41
STEERING LH	6E5900	P-UB-10	1-3/4	2-3/4	CTC-1539053	HEAD# 1515349	98.31
	6E5900	P-UB-10	1-3/4	2-3/4	CTC-1857024	HEAD# 6E4941	35.89
	6E5973	P-UB-10	1-1/2	2-3/4	CTC-1361599		69.45
	6E5972	P-UB-10	1-3/4	2-3/4	CTC-1539053	HEAD# 1515349	98.31
	6E5972	P-UB-10	1-3/4	2-3/4	CTC-1857024	HEAD# 6E4941	35.89
STEERING RH	6E5985	P-UB-10	1-1/2	2-3/4	CTC-1361599		69.45
TILT	9T5151	P-UB-10	2	3-1/2	CTC-1857674		75.33

REPLACEMENT KITS FOR CATERPILLAR® EQUIPMENT

CATERPILLAR®

Integrated Toolcarriers							
APPLICATION	CYL #	CODE	ROD	BORE	KIT #	Misc-Serial #'s, Parts, etc.	List \$
MODEL IT14B							
LIFT	9T5152	P-UB-10	2-1/4	4	CTC-1859527		74.75
PIN PULLER	9T5729	I-O-3	3/4	1-1/4	CTC-1791749		3.50
STEERING	4T8579	I-U-3	3/4	1-1/4	CTC-1791715		9.84
	9T5729	I-O-3	3/4	1-1/4	CTC-1791749		3.50
STEERING LH	9T7209	P-UB-10	1-1/2	2-3/4	CTC-1361599	HEAD# 6E4940	69.45
	9T7209	P-UB-10	1-1/2	2-3/4	CTC-7X2736	HEAD# 9T2542	82.41
	9T7210	P-UB-10	1-1/2	2-3/4	CTC-1361599	HEAD# 6E4940	69.45
	9T7210	P-UB-10	1-1/2	2-3/4	CTC-7X2736	HEAD# 9T2542	82.41
	6E5973	P-UB-10	1-1/2	2-3/4	CTC-1361599		69.45
	9T7209	P-UB-10	1-1/2	2-3/4	CTC-1361599	HEAD# 6E4940	69.45
STEERING RH	9T7209	P-UB-10	1-1/2	2-3/4	CTC-7X2736	HEAD# 9T2542	82.41
	6E5985	P-UB-10	1-1/2	2-3/4	CTC-1361599		69.45
TILT	9T5151	P-UB-10	2	3-1/2	CTC-1857674		75.33
MODEL IT14C							
TILT	9T5151	P-UB-10	2	3-1/2	CTC-7X2783		67.15
MODEL IT14F							
LIFT	6E6398	P-UB-10	2-1/4	3-1/2	CTC-1859503		89.68
STEERING	4T8579	I-U-3	3/4	1-1/4	CTC-1791715		9.84
	9T5729	I-O-3	3/4	1-1/4	CTC-1791749		3.50
STEERING LH	6E5900	P-UB-10	1-3/4	2-3/4	CTC-1539053	HEAD# 1515349	98.31
	6E5900	P-UB-10	1-3/4	2-3/4	CTC-1857024	HEAD# 6E4941	35.89
STEERING RH	6E5972	P-UB-10	1-3/4	2-3/4	CTC-1539053	HEAD# 1515349	98.31
	6E5972	P-UB-10	1-3/4	2-3/4	CTC-1857024	HEAD# 6E4941	35.89
MODEL IT14G							
FK	1491381	P-UB-10	2	3-1/2	CTC-1857674		75.33
LIFT	1116244	P-UB-10	2-1/4	3-1/2	CTC-1859503		89.68
	1314401	P-UB-10	2-1/4	3-1/2	CTC-1859503		89.68
	1314402	P-UB-10	2-1/4	3-1/2	CTC-1859503		89.68
	1044187	P-UB-10	1-1/2	2-1/2	CTC-1856601		33.77
STEERING	4T8579	I-U-3	3/4	1-1/4	CTC-1791715		9.84
	9T8823	I-O-3	1	2	CTC-9T0418		54.12
MODEL IT18							
LIFT	4T5544	I-O-3	1	2	CTC-9T0418		54.12
	4T8648	P-UB-10	2-1/4	4-1/4	CTC-1859507	HEAD# 3G2956	72.45
	4T8648	P-UB-10	2-1/4	4-1/4	CTC-1859517	HEAD# 9T7349	87.04
M.P. BUCKET TILT	4T4666	P-UB-10	2-1/2	4	CTC-1864338		53.22
PIN COUPLER	9T2352	I-O-3	1	2	CTC-9T0418		54.12
PIN PULLER	6E5392	I-O-3	1	2	CTC-9T0418		54.12
	6E5393	I-O-3	1	2	CTC-9T0418		54.12
SPECIAL APPLICATION	6E0906	I-O-3	1	2	CTC-9T0418		54.12
STEERING	1U3322	P-UB-10	1-1/2	3	CTC-1856587		39.61
	4T9981	I-O-3	1	2	CTC-9T0418		54.12
	6E0906	I-O-3	1	2	CTC-9T0418		54.12
	6E5392	I-O-3	1	2	CTC-9T0418		54.12
	9T2352	I-O-3	1	2	CTC-9T0418		54.12
TILT	4T4666	P-UB-10	2-1/2	4	CTC-1864338		53.22
MODEL IT18B							
LIFT	4T5544	I-O-3	1	2	CTC-9T0418		54.12

REPLACEMENT KITS FOR CATERPILLAR® EQUIPMENT

Integrated Toolcarriers							
APPLICATION	CYL #	CODE	ROD	BORE	KIT #	Misc-Serial #'s, Parts, etc.	List \$
MODEL IT18B							
LIFT	4T9981	I-O-3	1	2	CTC-9T0418		54.12
	6E0906	I-O-3	1	2	CTC-9T0418		54.12
	6E5392	I-O-3	1	2	CTC-9T0418		54.12
	6E5393	I-O-3	1	2	CTC-9T0418		54.12
	9T2352	I-O-3	1	2	CTC-9T0418		54.12
	9T5030	P-UB-10	2-1/2	4-3/4	CTC-1328811	HEAD# 9T5031	105.26
PIN COUPLER	4T9981	I-O-3	1	2	CTC-9T0418		54.12
	6E5392	I-O-3	1	2	CTC-9T0418		54.12
	6E5393	I-O-3	1	2	CTC-9T0418		54.12
	9T2352	I-O-3	1	2	CTC-9T0418		54.12
	9T8485	I-O-3	1	2	CTC-9T0418		54.12
SPECIAL APPLICATION	4T5544	I-O-3	1	2	CTC-9T0418		54.12
	6E0906	I-O-3	1	2	CTC-9T0418		54.12
STEERING	1U3322	P-UB-10	1-1/2	3	CTC-1856587		39.61
	9T8485	I-O-3	1	2	CTC-9T0418		54.12
TILT	9T5267	P-UB-10	2	4	CTC-1857688		45.41
MODEL IT18F							
LIFT	1007020	P-UB-10	2-1/2	4-3/4	CTC-1361131	HEAD# 1206679	107.38
	1007020	P-UB-10	2-1/2	4-3/4	CTC-1864381	HEAD# 9T3609	101.31
	1341379	P-UB-10	2-1/2	4-3/4	CTC-1361131		107.38
	9T7044	P-UB-10	2-1/2	4-3/4	CTC-1864381		101.31
PIN PULLER	9T8823	I-O-3	1	2	CTC-9T0418		54.12
	6E5393	I-O-3	1	2	CTC-9T0418		54.12
STEERING	6E1114	I-O-3	1	2	CTC-9T0418		54.12
TILT	9T2637	P-UB-10	1-1/2	2-3/4	CTC-1361599		69.45
	1341380	P-UB-10	2	4	CTC-1857688		45.41
	9T7026	P-UB-10	2	4	CTC-1857688		45.41
MODEL IT24F							
LIFT	1007020	P-UB-10	2-1/2	4-3/4	CTC-1361131	HEAD# 1206679	107.38
	1007020	P-UB-10	2-1/2	4-3/4	CTC-1864381	HEAD# 9T3609	101.31
	1341379	P-UB-10	2-1/2	4-3/4	CTC-1361131		107.38
	1342327	P-UB-10	2-1/4	4	CTC-1546526		98.29
	9T3937	P-UB-10	2-1/4	4	CTC-1546526		98.29
	9T8823	I-O-3	1	2	CTC-9T0418		54.12
STEERING	9T2637	P-UB-10	1-1/2	2-3/4	CTC-1361599		69.45
TILT	1107845	P-UB-10	2-1/2	4-1/2	CTC-1113300	HEAD# 1206679	89.05
	1107845	P-UB-10	2-1/2	4-1/2	CTC-1469860	HEAD# 9T3609	105.16
	1262492	P-UB-10	2	4	CTC-1113302		77.57
	1262492	P-UB-10	2	4	CTC-1857688		45.41
	1341380	P-UB-10	2	4	CTC-1857688		45.41
	1341381	P-UB-10	2	4	CTC-1857688		45.41
	1342671	P-UB-10	2-1/2	4-1/2	CTC-1113300		89.05
	6E1114	I-O-3	1	2	CTC-9T0418		54.12
	6E4651	P-UB-10	2-1/2	4-1/2	CTC-1113300	HEAD# 1206679	89.05
	6E4651	P-UB-10	2-1/2	4-1/2	CTC-1469860	HEAD# 9T3609	105.16
	9T7026	P-UB-10	2	4	CTC-1857688		45.41
MODEL IT28							
LIFT	3G2991	P-UB-10	2-1/2	4-3/4	CTC-1328811		105.26

REPLACEMENT KITS FOR CATERPILLAR® EQUIPMENT

CATERPILLAR®

Integrated Toolcarriers							
APPLICATION	CYL #	CODE	ROD	BORE	KIT #	Misc-Serial #'s, Parts, etc.	List \$
MODEL IT28							
PIN PULLER	6E5392	I-O-3	1	2	CTC-9T0418		54.12
	6E5393	I-O-3	1	2	CTC-9T0418		54.12
	9T2352	I-O-3	1	2	CTC-9T0418		54.12
SPECIAL APPLICATION	4T5544	I-O-3	1	2	CTC-9T0418		54.12
	6E0906	I-O-3	1	2	CTC-9T0418		54.12
STEERING	3G3501	P-UB-10	1-1/2	3	CTC-1372530		58.90
	4T9981	I-O-3	1	2	CTC-9T0418		54.12
	6E0906	I-O-3	1	2	CTC-9T0418		54.12
	6E5392	I-O-3	1	2	CTC-9T0418		54.12
TILT	9T2352	I-O-3	1	2	CTC-9T0418		54.12
	4T5544	I-O-3	1	2	CTC-9T0418		54.12
	4T5545	P-UB-10	2-1/2	4-1/4	CTC-1864336	HEAD# 8J8431	59.09
TILT MP, BUCKET	4T5545	P-UB-10	2-1/2	4-1/4	CTC-1864373	HEAD# 9T6548	66.90
	4T5545	P-UB-10	2-1/2	4-1/4	CTC-1864336	HEAD# 8J8431	59.09
4T5545	P-UB-10	2-1/2	4-1/4	CTC-1864373	HEAD# 9T6548	66.90	
MODEL IT28B							
LIFT	3G2991	P-UB-10	2-1/2	4-3/4	CTC-1328811		105.26
	4T8648	P-UB-10	2-1/4	4-1/4	CTC-1859507	HEAD# 3G2956	72.45
	4T8648	P-UB-10	2-1/4	4-1/4	CTC-1859517	HEAD# 9T7349	87.04
PIN COUPLER	4T9981	I-O-3	1	2	CTC-9T0418		54.12
	6E5392	I-O-3	1	2	CTC-9T0418		54.12
	9T2352	I-O-3	1	2	CTC-9T0418		54.12
	9T8485	I-O-3	1	2	CTC-9T0418		54.12
SPECIAL APPLICATION	4T5544	I-O-3	1	2	CTC-9T0418		54.12
	6E0906	I-O-3	1	2	CTC-9T0418		54.12
STEERING	1U3322	P-UB-10	1-1/2	3	CTC-1856587		39.61
	3G3501	P-UB-10	1-1/2	3	CTC-7X2751		41.76
	3G5110	P-UB-10	1-3/4	3-1/2	CTC-7X2762		65.25
	3G5110	P-UB-10	1-3/4	3-1/2	CTC-7X2784		36.73
	4T9981	I-O-3	1	2	CTC-9T0418		54.12
	6E0906	I-O-3	1	2	CTC-9T0418		54.12
	6E5392	I-O-3	1	2	CTC-9T0418		54.12
	6E5393	I-O-3	1	2	CTC-9T0418		54.12
	9T2352	I-O-3	1	2	CTC-9T0418		54.12
	9T8485	I-O-3	1	2	CTC-9T0418		54.12
TILT	3G6571	P-UB-10	2-1/2	4-3/4	CTC-1328811		105.26
	4T5544	I-O-3	1	2	CTC-9T0418		54.12
	4T5545	P-UB-10	2-1/2	4-1/4	CTC-1864336	HEAD# 8J8431	59.09
	4T5545	P-UB-10	2-1/2	4-1/4	CTC-1864373	HEAD# 9T6548	66.90
TILT MP, BUCKET	4T5545	P-UB-10	2-1/2	4-1/4	CTC-1864336	HEAD# 8J8431	59.09
	4T5545	P-UB-10	2-1/2	4-1/4	CTC-1864373	HEAD# 9T6548	66.90
MODEL IT28F							
LIFT	1341384	P-UB-10	2-1/2	4-3/4	CTC-1361131		107.38
	9T6788	P-UB-10	2-1/2	4-3/4	CTC-1361131	HEAD# 1206679	107.38
	9T6788	P-UB-10	2-1/2	4-3/4	CTC-1864381	HEAD# 9T3609	101.31
	9T8823	I-O-3	1	2	CTC-9T0418		54.12
PIN PULLER	6E5393	I-O-3	1	2	CTC-9T0418		54.12
STEERING	6E1114	I-O-3	1	2	CTC-9T0418		54.12

REPLACEMENT KITS FOR CATERPILLAR® EQUIPMENT

CATERPILLAR®

Integrated Toolcarriers							
APPLICATION	CYL #	CODE	ROD	BORE	KIT #	Misc-Serial #'s, Parts, etc.	List \$
MODEL IT28F							
STEERING	9T6646	P-UB-10	1-1/2	2-3/4	CTC-1361599		69.45
TILT	1341385	P-UB-10	2	4	CTC-1857688		45.41
	9T6929	P-UB-10	2	4	CTC-1857688		45.41
MODEL IT28G							
LIFT	1191060	P-UB-10	2-1/2	4-3/4	CTC-1361131		107.38
	6E1114	I-O-3	1	2	CTC-9T0418		54.12
	9T8823	I-O-3	1	2	CTC-9T0418		54.12
STEERING LH	1250374	P-UB-10	1-1/2	2-3/4	CTC-1361599		69.45
STEERING RH	1250373	P-UB-10	1-1/2	2-3/4	CTC-1361599		69.45
TILT	1191852	P-UB-10	2	4	CTC-1857688		45.41
	1273020	P-UB-10	2	4	CTC-1857688		45.41
MODEL IT38F							
LIFT	1148131	P-UB-10	3	4-3/4	CTC-1915030		105.55
STEERING	1050094	P-UB-10	1-3/4	3	CTC-1857025		30.26
TILT	1156963	P-UB-10	2-3/4	4-1/2	CTC-1933117		72.74
MODEL IT38G							
LIFT	1148131	P-UB-10	3	4-3/4	CTC-1570288		112.41
STEERING	1050094	P-UB-10	1-3/4	3	CTC-7X2825		32.51
	1393312	P-UB-10	1-3/4	3	CTC-7X2825		32.51
MODEL IT62G							
LIFT RH	1188296	P-UB-10	3	6	CTC-7X2698		121.48
	1250024	P-UB-10	3	6	CTC-7X2698		121.48
STEERING	1188288	P-UB-10	1-3/4	3-1/2	CTC-7X2784		36.73
TILT	1349397	P-UB-10	3	5-1/4	CTC-3E3293		115.90
Landfill Compactors							
APPLICATION	CYL #	CODE	ROD	BORE	KIT #	Misc-Serial #'s, Parts, etc.	List \$
MODEL 816							
LIFT	1U2088	P-UB-10	2-1/2	4-3/4	CTC-7X2660		117.13
	4J9233	P-V-10	2	4-1/2	CTC-7X2770		63.86
STEERING	4T1574	P-UB-10	2	4	CTC-7X2789		66.51
STEERING LH	7J9356	P-UB-10	2	4	CTC-7X2755		89.10
STEERING RH	7J9355	P-UB-10	2	4	CTC-7X2755		89.10
MODEL 816B							
DOZER	1U2088	P-UB-10	2-1/2	4-3/4	CTC-1328811		105.26
DOZER LIFT	1U2088	P-UB-10	2-1/2	4-3/4	CTC-7X2660		117.13
STEERING	4T1574	P-UB-10	2	4	CTC-1328816		60.48
	6E5024	P-UB-10	2	4	CTC-1113302		77.57
STEERING LH	7J9356	P-UB-10	2	4	CTC-7X2755		89.10
MODEL 816F							
DOZER	1U2088	P-UB-10	2-1/2	4-3/4	CTC-1328811		105.26
STEERING	4T1574	P-UB-10	2	4	CTC-1328816		60.48
	6E5024	P-UB-10	2	4	CTC-1113302		77.57
MODEL 826B							
LIFT	7K9401	P-UB-10	2-1/4	5	CTC-7X2729		105.87
	8J2650	P-UB-10	2	4-1/2	CTC-7X2768		57.83
	9J7111	P-UB-10	2-1/2	5-1/2	CTC-7X2653		105.93
STEERING	7J9718	P-UB-10	2-1/4	5	CTC-7X2729		105.87
STEERING LH	9J7087	P-UB-10	2-1/4	5	CTC-7X2729		105.87

REPLACEMENT KITS FOR CATERPILLAR® EQUIPMENT

CATERPILLAR®

Landfill Compactors							
APPLICATION	CYL #	CODE	ROD	BORE	KIT #	Misc-Serial #'s, Parts, etc.	List \$
MODEL 826B							
STEERING RH	9J7086	P-UB-10	2-1/4	5	CTC-7X2729		105.87
MODEL 826C							
LIFT	8J2650	P-UB-10	2	4-1/2	CTC-7X2768		57.83
	9J7111	P-UB-10	2-1/2	5-1/2	CTC-7X2653		105.93
STEERING	9J7086	P-UB-10	2-1/4	5	CTC-9X6392		104.34
	9J7087	P-UB-10	2-1/4	5	CTC-9X6392		104.34
MODEL 826G							
DOZER	1164842	P-UB-10	3	4-3/4	CTC-1570288		112.41
STEERING	1175151	P-UB-10	2-1/2	4-1/2	CTC-1113300		89.05
MODEL 836, 836C							
LIFT	6J1272	P-V-10	2-1/2	6-1/2	CTC-7X2676		71.34
STEERING	9J8165	P-UB-10	2-1/4	5	CTC-9X6392		104.34
Motor Graders							
APPLICATION	CYL #	CODE	ROD	BORE	KIT #	Misc-Serial #'s, Parts, etc.	List \$
MODEL 12, 12E, 12F, 112, 112E, 112F, 120, 120B							
STEERING	4J4115	P-UB-10	1-1/2	4	CTC-7X2738		57.03
MODEL 12G							
ARTICULATION	8J0546	P-UB-10	1-3/4	3	CTC-7X2791		57.77
	9T2453	P-UB-10	1-3/4	3	CTC-7X2825		32.51
	9T8784	P-UB-10	1-3/4	3	CTC-7X2825		32.51
BACKHOE STICK / BLADE SHIFT	8J0028	P-UB-10	1-3/4	3	CTC-7X2791		57.77
BLADE	3G5223	P-UB-10	2	3-1/4	CTC-7X2767		41.87
	8J6380	P-UB-10	2	3-1/4	CTC-7X2767		41.87
	9T2472	P-UB-10	2	3	CTC-7X2753		38.58
	9T2472	P-UB-10	2	3	CTC-7X2760		41.93
BLADE TIP	6E1549	P-UB-10	1-1/2	2-3/4	CTC-1361599		69.45
	8J0024	P-UB-10	1-1/2	2-3/4	CTC-7X2749		38.50
	8J0024	P-UB-10	1-1/2	2-3/4	CTC-8T1402		32.69
	9J3466	P-UB-10	1-1/2	2-3/4	CTC-7X2749		38.50
	9T2461	P-UB-10	1-1/2	2-3/4	CTC-1361599		69.45
CENTER SHIFT	3G5224	P-UB-10	2	3-1/4	CTC-7X2767		41.87
	9T2549	P-UB-10	2	3	CTC-7X2760		41.93
CONVEYOR SWING	3G5224	P-UB-10	2	3-1/4	CTC-7X2767		41.87
	8J6367	P-UB-10	2	3-1/4	CTC-7X2767		41.87
	9T2549	P-UB-10	2	3	CTC-7X2760		41.93
RIPPER	1137754	P-UB-10	2	4	CTC-1328816		60.48
	8J1658	P-UB-10	2	4	CTC-1328816		60.48
SCARIFIER	3G1853	P-UB-10	1-3/4	3	CTC-7X2791		57.77
	8J7321	P-UB-10	1-1/2	3	CTC-7X2751		41.76
	9T2554	P-UB-10	1-3/4	3	CTC-7X2825		32.51
	9T6951	P-UB-10	1-3/4	3	CTC-7X2825		32.51
SIDESHIFT	1052094	P-UB-10	1-3/4	3	CTC-7X2825		32.51
	9T2483	P-UB-10	1-3/4	3	CTC-7X2825		32.51
STEERING LH	3G8070	P-UB-10	1-1/2	2-1/2	CTC-7X2739		36.86
	8J8820	P-UB-10	1-1/2	2-1/2	CTC-7X2739		36.86
	9T2395	P-UB-10	1-1/2	2-1/4	CTC-7X2826		26.56
STEERING RH	3G8069	P-UB-10	1-1/2	2-1/2	CTC-7X2739		36.86

REPLACEMENT KITS FOR CATERPILLAR® EQUIPMENT



Motor Graders							
APPLICATION	CYL #	CODE	ROD	BORE	KIT #	Misc-Serial #'s, Parts, etc.	List \$
MODEL 12G							
STEERING RH	8J5538	P-UB-10	1-1/2	2-1/2	CTC-7X2739		36.86
	9T2393	P-UB-10	1-1/2	2-1/4	CTC-7X2826		26.56
WHEEL LEAN	1219242	P-UB-10	2	3-1/2	CTC-7X2783		67.15
	3G4752	P-UB-10	1-1/2	3-1/2	CTC-7X2752		62.21
	8J5539	P-UB-10	1-1/2	3-1/2	CTC-7X2752		62.21
	9T2520	P-UB-10	1-1/2	3-1/2	CTC-1327058		67.73
MODEL 12H							
ARTICULATION	6E1560	P-UB-10	1-3/4	3	CTC-7X2825		32.51
	9T8784	P-UB-10	1-3/4	3	CTC-7X2825		32.51
BLADE	1324929	P-UB-10	2	3	CTC-7X2760		41.93
BLADE TIP	6E1549	P-UB-10	1-1/2	2-3/4	CTC-1361599		69.45
CONVEYOR SWING	6E1343	P-UB-10	2	3	CTC-7X2760		41.93
RIPPER	1137754	P-UB-10	2	4	CTC-1328816		60.48
SCARIFIER	9T2554	P-UB-10	1-3/4	3	CTC-7X2825		32.51
	9T6951	P-UB-10	1-3/4	3	CTC-7X2825		32.51
SIDESHIFT	1125575	P-UB-10	1-3/4	3	CTC-7X2825		32.51
STEERING LH	9T2395	P-UB-10	1-1/2	2-1/4	CTC-7X2826		26.56
STEERING RH	9T2393	P-UB-10	1-1/2	2-1/4	CTC-7X2826		26.56
WHEEL LEAN	1219242	P-UB-10	2	3-1/2	CTC-7X2783		67.15
	9T2520	P-UB-10	1-1/2	3-1/2	CTC-1327058		67.73
MODEL 14							
LIFT	3G5227	P-UB-10	2-1/4	3-3/4	CTC-7X2798		49.49
STEERING	4J4115	P-UB-10	1-1/2	4	CTC-7X2738		57.03
STEERING LH	3G7644	P-UB-10	1-1/2	2-3/4	CTC-7X2749		38.50
STEERING RH	3G7643	P-UB-10	1-1/2	2-3/4	CTC-7X2749		38.50
MODEL 14D, 140							
STEERING	4J4115	P-UB-10	1-1/2	4	CTC-7X2738		57.03
MODEL 14E							
ARTICULATION	8J6269	P-UB-10	2	3-1/2	CTC-7X2792		57.24
	9T2879	P-UB-10	2	3-1/2	CTC-7X2783		67.15
BLADE SHIFT	4T0340	P-UB-10	2-1/2	4	CTC-7X2665		108.85
	8J6359	P-UB-10	2-1/4	3-3/4	CTC-7X2798		49.49
BLADE TIP	4T0379	P-UB-10	2	4	CTC-7X2789		66.51
CENTER SHIFT	3G5228	P-UB-10	2-1/4	3-3/4	CTC-7X2798		49.49
DRAWBAR TIP	8J6256	P-UB-10	1-1/2	3	CTC-7X2751		41.76
LIFT	3G5227	P-UB-10	2-1/4	3-3/4	CTC-7X2798		49.49
	8J6010	P-UB-10	2-1/4	3-3/4	CTC-7X2798		49.49
LIFT RH	6J5843	P-UB-10	2-1/2	5	CTC-7X2675		81.02
LIFT RIPPER	3G1762	P-UB-10	2-1/2	5	CTC-7X2658		113.62
	3G5189	P-UB-10	2-1/2	5	CTC-7X2658		113.62
RIPPER	5J7686	P-UB-10	2-1/2	6-1/2	CTC-7X2666		110.77
STEERING	1U2704	P-UB-10	2	3-1/2	CTC-7X2792		57.24
	4J4115	P-UB-10	1-1/2	4	CTC-7X2738		57.03
	8J5386	P-UB-10	1-1/2	2-3/4	CTC-7X2749		38.50
	9J0541	P-UB-10	1-1/2	2-3/4	CTC-7X2749		38.50
STEERING LH	3G7644	P-UB-10	1-1/2	2-3/4	CTC-7X2749		38.50
STEERING RH	3G7643	P-UB-10	1-1/2	2-3/4	CTC-7X2749		38.50
WHEEL LEAN	3G4751	P-UB-10	1-1/2	3-1/2	CTC-7X2752		62.21

REPLACEMENT KITS FOR CATERPILLAR® EQUIPMENT

CATERPILLAR®

Motor Graders							
APPLICATION	CYL #	CODE	ROD	BORE	KIT #	Misc-Serial #'s, Parts, etc.	List \$
MODEL 14E							
WHEEL LEAN	8J5385	P-UB-10	1-1/2	3-1/2	CTC-7X2752		62.21
	9T3219	P-UB-10	1-1/2	3-1/2	CTC-1327058		67.73
MODEL 14G							
ARTICULATION	1U2704	P-UB-10	2	3-1/2	CTC-7X2792		57.24
	6E2446	P-UB-10	2	3-1/2	CTC-7X2783		67.15
	6E4724	P-UB-10	2	3-1/2	CTC-7X2783		67.15
	9T2879	P-UB-10	2	3-1/2	CTC-7X2783		67.15
BACKHOE STICK / BLADE SHIFT	8J6359	P-UB-10	2-1/4	3-3/4	CTC-7X2798		49.49
BLADE	8J6010	P-UB-10	2-1/4	3-3/4	CTC-7X2798		49.49
BLADE LIFT	3G5227	P-UB-10	2-1/4	3-3/4	CTC-7X2798		49.49
BLADE TIP	9T3198	P-UB-10	2	4	CTC-1328816		60.48
	9T8944	P-UB-10	2	4	CTC-1328816		60.48
CENTER SHIFT	3G5228	P-UB-10	2-1/4	3-3/4	CTC-7X2798		49.49
CONVEYOR SWING	3G5228	P-UB-10	2-1/4	3-3/4	CTC-7X2798		49.49
	8J6250	P-UB-10	2-1/4	3-3/4	CTC-7X2798		49.49
DRAWBAR TIP	8J6256	P-UB-10	1-3/4	3	CTC-7X2791		57.77
LIFT RH	6J5843	P-UB-10	2-1/2	5	CTC-7X2675		81.02
RIPPER	1135264	P-UB-10	2-1/2	5	CTC-1361967		126.36
	3G1762	P-UB-10	2-1/2	5	CTC-1315106		110.14
	3G5189	P-UB-10	2-1/2	5	CTC-7X2658		113.62
SIDESHIFT	4T0340	P-UB-10	2-1/2	4	CTC-7X2665		108.85
	9T3206	P-UB-10	2-1/2	4	CTC-1542501		98.74
STEERING LH	3G7644	P-UB-10	1-1/2	2-3/4	CTC-7X2749		38.50
	9J0541	P-UB-10	1-1/2	2-3/4	CTC-7X2749		38.50
	9T1721	P-UB-10	1-3/4	2-1/2	CTC-1539054		94.09
STEERING RH	3G7643	P-UB-10	1-1/2	2-3/4	CTC-7X2749		38.50
	8J5386	P-UB-10	1-1/2	2-3/4	CTC-7X2749		38.50
	9T1301	P-UB-10	1-3/4	2-1/2	CTC-1539054		94.09
TIP	4T0379	P-UB-10	2	4	CTC-1328816		60.48
WHEEL LEAN	1219243	P-UB-10	2	3-1/2	CTC-7X2783		67.15
	3G4751	P-UB-10	1-1/2	3-1/2	CTC-7X2752		62.21
	8J5385	P-UB-10	1-1/2	3-1/2	CTC-7X2752		62.21
	9T3219	P-UB-10	1-1/2	3-1/2	CTC-1327058		67.73
MODEL 14H							
ARTICULATION	6E2446	P-UB-10	2	3-1/2	CTC-7X2783		67.15
	6E4724	P-UB-10	2	3-1/2	CTC-7X2783		67.15
	9T2879	P-UB-10	2	3-1/2	CTC-7X2783		67.15
BLADE TIP	9T3198	P-UB-10	2	4	CTC-1328816		60.48
	9T8944	P-UB-10	2	4	CTC-1328816		60.48
RIPPER	1135264	P-UB-10	2-1/2	5	CTC-1361967		126.36
SIDESHIFT	9T3206	P-UB-10	2-1/2	4	CTC-1542501		98.74
STEERING LH	9T1721	P-UB-10	1-3/4	2-1/2	CTC-1539054		94.09
STEERING RH	9T1301	P-UB-10	1-3/4	2-1/2	CTC-1539054		94.09
WHEEL LEAN	1219243	P-UB-10	2	3-1/2	CTC-7X2783		67.15
	9T3219	P-UB-10	1-1/2	3-1/2	CTC-1327058		67.73
MODEL 16							
BLADE LH	6J5844	P-UB-10	2-1/2	5	CTC-7X2675		81.02

REPLACEMENT KITS FOR CATERPILLAR® EQUIPMENT

Motor Graders							
APPLICATION	CYL #	CODE	ROD	BORE	KIT #	Misc-Serial #'s, Parts, etc.	List \$
MODEL 16							
BLADE RH	6J5843	P-UB-10	2-1/2	5	CTC-7X2675		81.02
LIFT	3G5229	P-UB-10	2-1/2	4-1/4	CTC-7X2663		32.21
STEERING	5J1931	P-V-10	2	5	CTC-7X2797		46.23
TIP	6J9731	P-UB-10	1-1/2	4	CTC-7X2738		57.03
	6J9732	P-UB-10	1-1/2	4	CTC-7X2738		57.03
MODEL 16G							
ARTICULATION	1U1649	P-UB-10	2-1/2	4	CTC-7X2665		108.85
	9T3050	P-UB-10	2-1/2	4	CTC-1542501		98.74
BLADE	9T3106	P-UB-10	2-1/2	4	CTC-1542501		98.74
BLADE LIFT	3G5229	P-UB-10	2-1/2	4-1/4	CTC-7X2663		32.21
	8J5568	P-UB-10	2-1/2	4-1/4	CTC-7X2663		32.21
BLADE TIP	6J9731	P-UB-10	1-1/2	4	CTC-7X2738		57.03
	6J9732	P-UB-10	1-1/2	4	CTC-7X2738		57.03
	9T3198	P-UB-10	2	4	CTC-1328816		60.48
	9T8944	P-UB-10	2	4	CTC-1328816		60.48
CENTER SHIFT	3G5230	P-UB-10	2-1/2	4-1/4	CTC-7X2663		32.21
CONVEYOR SWING	9T3312	P-UB-10	2-1/2	4	CTC-1542501		98.74
DRAWBAR TIP	8J3761	P-UB-10	1-3/4	3	CTC-7X2791		57.77
LIFT	8J5827	P-UB-10	2-1/2	4-1/4	CTC-7X2663		32.21
LIFT LH	6J5844	P-UB-10	2-1/2	5	CTC-7X2675		81.02
LIFT RH	6J5843	P-UB-10	2-1/2	5	CTC-7X2675		81.02
RIPPER	1135264	P-UB-10	2-1/2	5	CTC-1361967		126.36
	3G1762	P-UB-10	2-1/2	5	CTC-1315106		110.14
	3G5189	P-UB-10	2-1/2	5	CTC-7X2658		113.62
SIDESHIFT	4T0340	P-UB-10	2-1/2	4	CTC-7X2665		108.85
	9T3206	P-UB-10	2-1/2	4	CTC-1542501		98.74
STEERING	1U2704	P-UB-10	2	3-1/2	CTC-7X2792		57.24
STEERING LH	3G7599	P-UB-10	1-3/4	3	CTC-7X2791		57.77
	8J3612	P-UB-10	1-3/4	3	CTC-7X2791		57.77
	9T2854	P-UB-10	1-3/4	2-3/4	CTC-1539053		98.31
STEERING RH	3G7600	P-UB-10	1-3/4	3	CTC-7X2791		57.77
	8J8411	P-UB-10	1-3/4	3	CTC-7X2791		57.77
	9T2853	P-UB-10	1-3/4	2-3/4	CTC-1539053		98.31
	9T2853	P-UB-10	1-3/4	2-3/4	CTC-7X2820		51.60
TIP	4T0379	P-UB-10	2	4	CTC-1328816		60.48
WHEEL LEAN	3G4750	P-UB-10	1-3/4	4	CTC-7X2790		60.62
	8J3613	P-UB-10	1-3/4	4	CTC-1316108		70.83
	9T3492	P-UB-10	1-3/4	4	CTC-1316108		70.83
MODEL 16H							
ARTICULATION	9T3050	P-UB-10	2-1/2	4	CTC-1542501		98.74
BLADE	9T3106	P-UB-10	2-1/2	4	CTC-1542501		98.74
BLADE TIP	9T3198	P-UB-10	2	4	CTC-1328816		60.48
	9T8944	P-UB-10	2	4	CTC-1328816		60.48
CONVEYOR SWING	9T3312	P-UB-10	2-1/2	4	CTC-1542501		98.74
RIPPER	1135264	P-UB-10	2-1/2	5	CTC-1361967		126.36
SIDESHIFT	9T3206	P-UB-10	2-1/2	4	CTC-1542501		98.74
STEERING LH	9T2854	P-UB-10	1-3/4	2-3/4	CTC-1539053		98.31
STEERING RH	9T2853	P-UB-10	1-3/4	2-3/4	CTC-1539053		98.31

REPLACEMENT KITS FOR CATERPILLAR® EQUIPMENT

Motor Graders							
APPLICATION	CYL #	CODE	ROD	BORE	KIT #	Misc-Serial #'s, Parts, etc.	List \$
MODEL 16H							
WHEEL LEAN	9T3492	P-UB-10	1-3/4	4	CTC-1316108		70.83
MODEL 24H							
ARTICULATION	1170837	P-UB-10	3	4-3/4	CTC-1570288		112.41
BLADE	1170832	P-UB-10	3	5-1/4	CTC-3E3293		115.90
RIPPER	1137754	P-UB-10	2	4	CTC-1328816		60.48
STEERING	1170833	I-UB-10	2-1/2	3-1/2	CTC-3E3299		87.43
TIP	1435988	P-UB-10	2-1/2	4-3/4	CTC-1361131	Rod Bearing width - 0.980"	107.38
WHEEL LEAN	1170836	P-UB-10	2-1/2	4-3/4	CTC-1361131	Rod Bearing width - 0.980"	107.38
MODEL 120G							
ARTICULATION	8J8590	P-UB-10	1-3/4	3	CTC-7X2791		57.77
	9T2447	P-UB-10	1-3/4	3	CTC-7X2825		32.51
	9T8785	P-UB-10	1-3/4	3	CTC-7X2825		32.51
BACKHOE STICK / BLADE SHIFT	8J0028	P-UB-10	1-3/4	3	CTC-7X2791		57.77
	9T2483	P-UB-10	1-3/4	3	CTC-7X2825		32.51
BLADE	3G5225	P-UB-10	1-3/4	3	CTC-7X2791		57.77
	8J8589	P-UB-10	1-3/4	3	CTC-7X2791		57.77
	9T2471	P-UB-10	1-3/4	3	CTC-7X2825		32.51
BLADE LIFT	3G5225	P-UB-10	1-3/4	3	CTC-7X2791		57.77
BLADE RH	6J5843	P-UB-10	2-1/2	5	CTC-7X2675		81.02
BLADE TIP	6E1549	P-UB-10	1-1/2	2-3/4	CTC-1361599		69.45
	8J0024	P-UB-10	1-1/2	2-3/4	CTC-7X2749		38.50
	9J3466	P-UB-10	1-1/2	2-3/4	CTC-7X2749		38.50
	9T2461	P-UB-10	1-1/2	2-3/4	CTC-1361599		69.45
	3G5226	P-UB-10	1-3/4	3	CTC-7X2791		57.77
CENTER SHIFT	8J6367	P-UB-10	2	3-1/4	CTC-7X2767		41.87
	9T2374	P-UB-10	1-3/4	3	CTC-7X2825		32.51
	3G5226	P-UB-10	1-3/4	3	CTC-7X2791		57.77
CONVEYOR SWING	8J8777	P-UB-10	1-3/4	3	CTC-7X2791		57.77
	9T2374	P-UB-10	1-3/4	3	CTC-7X2825		32.51
	3G1853	P-UB-10	1-3/4	3	CTC-7X2791		57.77
SCARIFIER	8J7321	P-UB-10	1-1/2	3	CTC-7X2751		41.76
	9T2554	P-UB-10	1-3/4	3	CTC-7X2825		32.51
	9T6951	P-UB-10	1-3/4	3	CTC-7X2825		32.51
SIDESHIFT	1052094	P-UB-10	1-3/4	3	CTC-7X2825		32.51
	8J0028	P-UB-10	1-3/4	3	CTC-7X2791		57.77
	9T2483	P-UB-10	1-3/4	3	CTC-7X2825		32.51
STEERING LH	3G8070	P-UB-10	1-1/2	2-1/2	CTC-7X2739		36.86
	8J8820	P-UB-10	1-1/2	2-1/2	CTC-7X2739		36.86
	9T2395	P-UB-10	1-1/2	2-1/4	CTC-7X2826		26.56
STEERING RH	3G8069	P-UB-10	1-1/2	2-1/2	CTC-7X2739		36.86
	8J5538	P-UB-10	1-1/2	2-1/2	CTC-7X2739		36.86
	9T2393	P-UB-10	1-1/2	2-1/4	CTC-7X2826		26.56
WHEEL LEAN	1219242	P-UB-10	2	3-1/2	CTC-7X2783		67.15
	3G4752	P-UB-10	1-1/2	3-1/2	CTC-7X2752		62.21
	8J5539	P-UB-10	1-1/2	3-1/2	CTC-7X2752		62.21
	9T2520	P-UB-10	1-1/2	3-1/2	CTC-1327058		67.73

REPLACEMENT KITS FOR CATERPILLAR® EQUIPMENT

Motor Graders							
APPLICATION	CYL #	CODE	ROD	BORE	KIT #	Misc-Serial #'s, Parts, etc.	List \$
MODEL 120H							
ARTICULATION	6E1554	P-UB-10	1-3/4	3	CTC-7X2825		32.51
	6E4724	P-UB-10	2	3-1/2	CTC-7X2783		67.15
	9T8785	P-UB-10	1-3/4	3	CTC-7X2825		32.51
BLADE	1125575	P-UB-10	1-3/4	3	CTC-7X2825		32.51
	1198664	P-UB-10	2	3	CTC-7X2760		41.93
	1324926	P-UB-10	2	3	CTC-7X2760		41.93
BLADE TIP	6E1549	P-UB-10	1-1/2	2-3/4	CTC-1361599		69.45
CONVEYOR SWING	6E1754	P-UB-10	2	3	CTC-7X2760		41.93
SCARIFIER	9T2554	P-UB-10	1-3/4	3	CTC-7X2825		32.51
	9T6951	P-UB-10	1-3/4	3	CTC-7X2825		32.51
STEERING LH	9T2395	P-UB-10	1-1/2	2-1/4	CTC-7X2826		26.56
STEERING RH	9T2393	P-UB-10	1-1/2	2-1/4	CTC-7X2826		26.56
WHEEL LEAN	1219242	P-UB-10	2	3-1/2	CTC-7X2783		67.15
	9T2520	P-UB-10	1-1/2	3-1/2	CTC-1327058		67.73
MODEL 130G							
ARTICULATION	8J0546	P-UB-10	1-3/4	3	CTC-7X2791		57.77
	9T2453	P-UB-10	1-3/4	3	CTC-7X2825		32.51
	9T8784	P-UB-10	1-3/4	3	CTC-7X2825		32.51
BACKHOE STICK / BLADE SHIFT	8J0028	P-UB-10	1-3/4	3	CTC-7X2791		57.77
	9T2483	P-UB-10	1-3/4	3	CTC-7X2825		32.51
BLADE	3G5223	P-UB-10	2	3-1/4	CTC-7X2767		41.87
	8J6380	P-UB-10	2	3-1/4	CTC-7X2767		41.87
	9T2472	P-UB-10	2	3	CTC-7X2760		41.93
BLADE LIFT	3G5223	P-UB-10	2	3-1/4	CTC-7X2767		41.87
	9T2471	P-UB-10	1-3/4	3	CTC-7X2825		32.51
	9T2472	P-UB-10	2	3	CTC-7X2753		38.58
BLADE TIP	6E1549	P-UB-10	1-1/2	2-3/4	CTC-1361599		69.45
	8J0024	P-UB-10	1-1/2	2-3/4	CTC-7X2749		38.50
	9J3466	P-UB-10	1-1/2	2-3/4	CTC-7X2749		38.50
	9T2461	P-UB-10	1-1/2	2-3/4	CTC-1361599		69.45
	3G5224	P-UB-10	2	3-1/4	CTC-7X2767		41.87
CENTER SHIFT	8J6367	P-UB-10	2	3-1/4	CTC-7X2767		41.87
	9T2549	P-UB-10	2	3	CTC-7X2760		41.93
	3G5224	P-UB-10	2	3-1/4	CTC-7X2767		41.87
CONVEYOR SWING	8J6367	P-UB-10	2	3-1/4	CTC-7X2767		41.87
	9T2549	P-UB-10	2	3	CTC-7X2760		41.93
	9T2471	P-UB-10	1-3/4	3	CTC-7X2825		32.51
LIFT	1137754	P-UB-10	2	4	CTC-1328816		60.48
RIPPER	8J1658	P-UB-10	2	4	CTC-1328816		60.48
SCARIFIER	3G1853	P-UB-10	1-3/4	3	CTC-7X2791		57.77
	8J7321	P-UB-10	1-1/2	3	CTC-7X2751		41.76
	9T2554	P-UB-10	1-3/4	3	CTC-7X2825		32.51
SIDESHIFT	9T6951	P-UB-10	1-3/4	3	CTC-7X2825		32.51
	1052094	P-UB-10	1-3/4	3	CTC-7X2825		32.51
	8J0028	P-UB-10	1-3/4	3	CTC-7X2791		57.77
STEERING LH	9T2483	P-UB-10	1-3/4	3	CTC-7X2825		32.51
	3G8070	P-UB-10	1-1/2	2-1/2	CTC-7X2739		36.86

REPLACEMENT KITS FOR CATERPILLAR® EQUIPMENT

Motor Graders							
APPLICATION	CYL #	CODE	ROD	BORE	KIT #	Misc-Serial #'s, Parts, etc.	List \$
MODEL 130G							
STEERING LH	8J8820	P-UB-10	1-1/2	2-1/2	CTC-7X2739		36.86
	9T2395	P-UB-10	1-1/2	2-1/4	CTC-7X2826		26.56
STEERING RH	3G8069	P-UB-10	1-1/2	2-1/2	CTC-7X2739		36.86
	8J5538	P-UB-10	1-1/2	2-1/2	CTC-7X2739		36.86
WHEEL LEAN	9T2393	P-UB-10	1-1/2	2-1/4	CTC-7X2826		26.56
	1219242	P-UB-10	2	3-1/2	CTC-7X2783		67.15
WHEEL LEAN	3G4752	P-UB-10	1-1/2	3-1/2	CTC-7X2752		62.21
	8J5539	P-UB-10	1-1/2	3-1/2	CTC-7X2752		62.21
	9T2520	P-UB-10	1-1/2	3-1/2	CTC-1327058		67.73
MODEL 135H							
ARTICULATION	6E1554	P-UB-10	1-3/4	3	CTC-7X2825		32.51
	6E4724	P-UB-10	2	3-1/2	CTC-7X2783		67.15
	9T8785	P-UB-10	1-3/4	3	CTC-7X2825		32.51
BLADE	1324926	P-UB-10	2	3	CTC-7X2760		41.93
BLADE TIP	6E1549	P-UB-10	1-1/2	2-3/4	CTC-1361599		69.45
CONVEYOR SWING	6E1754	P-UB-10	2	3	CTC-7X2760		41.93
SCARIFIER	9T2554	P-UB-10	1-3/4	3	CTC-7X2825		32.51
	9T6951	P-UB-10	1-3/4	3	CTC-7X2825		32.51
SIDESHIFT	1125575	P-UB-10	1-3/4	3	CTC-7X2825		32.51
STEERING LH	9T2395	P-UB-10	1-1/2	2-1/4	CTC-7X2826		26.56
STEERING RH	9T2393	P-UB-10	1-1/2	2-1/4	CTC-7X2826		26.56
WHEEL LEAN	1219242	P-UB-10	2	3-1/2	CTC-7X2783		67.15
	9T2520	P-UB-10	1-1/2	3-1/2	CTC-1327058		67.73
MODEL 140B							
RIPPER	3G5189	P-UB-10	2-1/2	5	CTC-7X2658		113.62
STEERING	4J4115	P-UB-10	1-1/2	4	CTC-7X2738		57.03
MODEL 140G							
ARTICULATION	8J0546	P-UB-10	1-3/4	3	CTC-7X2791		57.77
	9T2453	P-UB-10	1-3/4	3	CTC-7X2825		32.51
	9T8784	P-UB-10	1-3/4	3	CTC-7X2825		32.51
BACKHOE STICK / BLADE SHIFT	8J0028	P-UB-10	1-3/4	3	CTC-7X2791		57.77
BLADE	3G5223	P-UB-10	2	3-1/4	CTC-7X2767		41.87
	8J6380	P-UB-10	2	3-1/4	CTC-7X2767		41.87
	9T2472	P-UB-10	2	3	CTC-7X2760		41.93
BLADE LIFT	9T2472	P-UB-10	2	3	CTC-7X2753		38.58
BLADE TIP	6E1549	P-UB-10	1-1/2	2-3/4	CTC-1361599		69.45
	8J0024	P-UB-10	1-1/2	2-3/4	CTC-7X2749		38.50
	9J3466	P-UB-10	1-1/2	2-3/4	CTC-7X2749		38.50
	9T2461	P-UB-10	1-1/2	2-3/4	CTC-1361599		69.45
CENTER SHIFT	3G5224	P-UB-10	2	3-1/4	CTC-7X2767		41.87
	8J6367	P-UB-10	2	3-1/4	CTC-7X2767		41.87
	9T2549	P-UB-10	2	3	CTC-7X2760		41.93
CONVEYOR SWING	3G5224	P-UB-10	2	3-1/4	CTC-7X2767		41.87
	8J6367	P-UB-10	2	3-1/4	CTC-7X2767		41.87
	9T2549	P-UB-10	2	3	CTC-7X2760		41.93
RIPPER	1137754	P-UB-10	2	4	CTC-1328816		60.48
	8J1658	P-UB-10	2	4	CTC-1328816		60.48

REPLACEMENT KITS FOR CATERPILLAR® EQUIPMENT

Motor Graders							
APPLICATION	CYL #	CODE	ROD	BORE	KIT #	Misc-Serial #'s, Parts, etc.	List \$
MODEL 140G							
RIPPER LIFT	3G5189	P-UB-10	2-1/2	5	CTC-7X2658		113.62
SCARIFIER	3G1853	P-UB-10	1-3/4	3	CTC-7X2791		57.77
	8J7321	P-UB-10	1-1/2	3	CTC-7X2751		41.76
	9T2554	P-UB-10	1-3/4	3	CTC-7X2825		32.51
	9T6951	P-UB-10	1-3/4	3	CTC-7X2825		32.51
SIDESHIFT	1052094	P-UB-10	1-3/4	3	CTC-7X2825		32.51
	8J0028	P-UB-10	1-3/4	3	CTC-7X2791		57.77
	9T2483	P-UB-10	1-3/4	3	CTC-7X2825		32.51
STEERING LH	3G8070	P-UB-10	1-1/2	2-1/2	CTC-7X2739		36.86
	8J8820	P-UB-10	1-1/2	2-1/2	CTC-7X2739		36.86
	9T2395	P-UB-10	1-1/2	2-1/4	CTC-7X2826		26.56
STEERING RH	3G8069	P-UB-10	1-1/2	2-1/2	CTC-7X2739		36.86
	8J5538	P-UB-10	1-1/2	2-1/2	CTC-7X2739		36.86
	9T2393	P-UB-10	1-1/2	2-1/4	CTC-7X2826		26.56
WHEEL LEAN	1219242	P-UB-10	2	3-1/2	CTC-7X2783		67.15
	3G4752	P-UB-10	1-1/2	3-1/2	CTC-7X2752		62.21
	4J4115	P-UB-10	1-1/2	4	CTC-7X2738		57.03
	8J5539	P-UB-10	1-1/2	3-1/2	CTC-7X2752		62.21
	9T2520	P-UB-10	1-1/2	3-1/2	CTC-1327058		67.73
MODEL 140H, 143H							
ARTICULATION	1376790	P-UB-10	1-7/8	3-1/4	CTC-3E3297		64.26
	1376792	P-UB-10	1-7/8	3-1/4	CTC-3E3297		64.26
	6E1560	P-UB-10	1-3/4	3	CTC-7X2825		32.51
	9T8784	P-UB-10	1-3/4	3	CTC-7X2825		32.51
BLADE	1324929	P-UB-10	2	3	CTC-7X2760		41.93
BLADE TIP	6E1549	P-UB-10	1-1/2	2-3/4	CTC-1361599		69.45
CONVEYOR SWING	6E1343	P-UB-10	2	3	CTC-7X2760		41.93
RIPPER	1137754	P-UB-10	2	4	CTC-1328816		60.48
SCARIFIER	9T2554	P-UB-10	1-3/4	3	CTC-7X2825		32.51
	9T6951	P-UB-10	1-3/4	3	CTC-7X2825		32.51
SIDESHIFT	1125575	P-UB-10	1-3/4	3	CTC-7X2825		32.51
STEERING LH	9T2395	P-UB-10	1-1/2	2-1/4	CTC-7X2826		26.56
STEERING RH	9T2393	P-UB-10	1-1/2	2-1/4	CTC-7X2826		26.56
WHEEL LEAN	1219242	P-UB-10	2	3-1/2	CTC-7X2783		67.15
	9T2520	P-UB-10	1-1/2	3-1/2	CTC-1327058		67.73
MODEL 160G							
ARTICULATION	8J0546	P-UB-10	1-3/4	3	CTC-7X2791		57.77
	9T2453	P-UB-10	1-3/4	3	CTC-7X2825		32.51
	9T8784	P-UB-10	1-3/4	3	CTC-7X2825		32.51
BACKHOE STICK / BLADE SHIFT	8J0028	P-UB-10	1-3/4	3	CTC-7X2791		57.77
BLADE	3G5223	P-UB-10	2	3-1/4	CTC-7X2767		41.87
	8J6380	P-UB-10	2	3-1/4	CTC-7X2767		41.87
	9T2472	P-UB-10	2	3	CTC-7X2753		38.58
	9T2472	P-UB-10	2	3	CTC-7X2760		41.93
BLADE LIFT	3G5223	P-UB-10	2	3-1/4	CTC-7X2767		41.87
	9T2472	P-UB-10	2	3	CTC-7X2753		38.58
BLADE TIP	6E1549	P-UB-10	1-1/2	2-3/4	CTC-1361599		69.45

REPLACEMENT KITS FOR CATERPILLAR® EQUIPMENT

Motor Graders							
APPLICATION	CYL #	CODE	ROD	BORE	KIT #	Misc-Serial #'s, Parts, etc.	List \$
MODEL 160G							
BLADE TIP	8J0024	P-UB-10	1-1/2	2-3/4	CTC-7X2749		38.50
	9J3466	P-UB-10	1-1/2	2-3/4	CTC-7X2749		38.50
	9T2461	P-UB-10	1-1/2	2-3/4	CTC-1361599		69.45
CENTER SHIFT	3G5224	P-UB-10	2	3-1/4	CTC-7X2767		41.87
	9T2549	P-UB-10	2	3	CTC-7X2760		41.93
CONVEYOR SWING	3G5224	P-UB-10	2	3-1/4	CTC-7X2767		41.87
	8J6367	P-UB-10	2	3-1/4	CTC-7X2767		41.87
	9T2549	P-UB-10	2	3	CTC-7X2760		41.93
SCARIFIER	3G1853	P-UB-10	1-3/4	3	CTC-7X2791		57.77
	9T2554	P-UB-10	1-3/4	3	CTC-7X2825		32.51
	9T6951	P-UB-10	1-3/4	3	CTC-7X2825		32.51
SIDESHIFT	1052094	P-UB-10	1-3/4	3	CTC-7X2825		32.51
	8J0028	P-UB-10	1-3/4	3	CTC-7X2791		57.77
	9T2483	P-UB-10	1-3/4	3	CTC-7X2825		32.51
STEERING LH	3G8070	P-UB-10	1-1/2	2-1/2	CTC-7X2739		36.86
	8J8820	P-UB-10	1-1/2	2-1/2	CTC-7X2739		36.86
	9T2395	P-UB-10	1-1/2	2-1/4	CTC-7X2826		26.56
STEERING RH	3G8069	P-UB-10	1-1/2	2-1/2	CTC-7X2739		36.86
	8J5538	P-UB-10	1-1/2	2-1/2	CTC-7X2739		36.86
	9T2393	P-UB-10	1-1/2	2-1/4	CTC-7X2826		26.56
WHEEL LEAN	1219242	P-UB-10	2	3-1/2	CTC-7X2783		67.15
	3G4752	P-UB-10	1-1/2	3-1/2	CTC-7X2752		62.21
	9T2520	P-UB-10	1-1/2	3-1/2	CTC-1327058		67.73
MODEL 160H, 163H							
ARTICULATION	1376790	P-UB-10	1-7/8	3-1/4	CTC-3E3297		64.26
	1376792	P-UB-10	1-7/8	3-1/4	CTC-3E3297		64.26
	6E1560	P-UB-10	1-3/4	3	CTC-7X2825		32.51
	9T8784	P-UB-10	1-3/4	3	CTC-7X2825		32.51
BLADE	1324929	P-UB-10	2	3	CTC-7X2760		41.93
BLADE TIP	6E1549	P-UB-10	1-1/2	2-3/4	CTC-1361599		69.45
CONVEYOR SWING	6E1343	P-UB-10	2	3	CTC-7X2760		41.93
RIPPER	1137754	P-UB-10	2	4	CTC-1328816		60.48
SCARIFIER	9T2554	P-UB-10	1-3/4	3	CTC-7X2825		32.51
	9T6951	P-UB-10	1-3/4	3	CTC-7X2825		32.51
SIDESHIFT	1125575	P-UB-10	1-3/4	3	CTC-7X2825		32.51
STEERING LH	9T2395	P-UB-10	1-1/2	2-1/4	CTC-7X2826		26.56
STEERING RH	9T2393	P-UB-10	1-1/2	2-1/4	CTC-7X2826		26.56
WHEEL LEAN	1219242	P-UB-10	2	3-1/2	CTC-7X2783		67.15
	9T2520	P-UB-10	1-1/2	3-1/2	CTC-1327058		67.73
Off-Highway Trucks							
APPLICATION	CYL #	CODE	ROD	BORE	KIT #	Misc-Serial #'s, Parts, etc.	List \$
MODEL 768							
HOIST	4T4168	I-SP-10	4,6-1/2	5-3/4	CTC-8T4772		205.11
STEERING	9J1287	P-UB-10	2-3/8	3-3/4	CTC-7X2808		52.57
SUSPENSION REAR	5J6572	I-SP-1	7	8-1/2	CTC-5J6572K		137.73
MODEL 768B							
STEERING	7J7528	P-UB-10	2-3/8	3-3/4	CTC-7X2808		52.57
	9J1287	P-UB-10	2-3/8	3-3/4	CTC-7X2808		52.57

REPLACEMENT KITS FOR CATERPILLAR® EQUIPMENT

Off-Highway Trucks							
APPLICATION	CYL #	CODE	ROD	BORE	KIT #	Misc-Serial #'s, Parts, etc.	List \$
MODEL 768B							
SUSPENSION REAR	5J6572	I-SP-1	7	8-1/2	CTC-5J6572K		137.73
MODEL 768C							
HOIST	9J4149	I-SP-10	4,6-1/2	5-3/4	CTC-8T4772		205.11
STEERING	9J1287	P-UB-10	2-3/8	3-3/4	CTC-7X2808		52.57
SUSPENSION REAR	5J6572	I-SP-1	7	8-1/2	CTC-5J6572K		137.73
MODEL 769, 769B							
STEERING	4J4627	I,P-V-10	1-1/2	3-1/2	CTC-4J4627K	99F1-99F1030	54.53
	4J4627	P-UB-10	1-1/2	3-1/2	CTC-7X2812	Field Replacement Kit	67.84
	6J1203	I-UB-10	2-3/8	3-3/4	CTC-6J1203K	99F1031-99F1198	76.66
	6J1203	P-UB-10	2-3/8	3-3/4	CTC-7X2808		52.57
	7J7528	P-UB-10	2-3/8	3-3/4	CTC-7X2808	99F1199-99F4068	52.57
	9J1287	P-UB-10	2-3/8	3-3/4	CTC-7X2808	99F4069-->	52.57
SUSPENSION REAR	4J8770	I-SP-1	7	8-1/2	CTC-4J8770K	99F1-99F1030	140.15
	5J6572	I-SP-1	7	8-1/2	CTC-5J6572K	99F1031-->; 35W	137.73
MODEL 769C							
HOIST	4T4168	I-SP-10	4,6-1/2	5-3/4	CTC-8T4772		205.11
	9J4149	I-SP-10	4,6-1/2	5-3/4	CTC-8T4772		205.11
STEERING	9J1287	P-UB-10	2-3/8	3-3/4	CTC-7X2808	1X1-->	52.57
SUSPENSION REAR	3G0688	I-SP-1	7	8-1/2	CTC-3G0688K	1X3272-->	137.73
	3G0688	I-SP-1	7	8-1/2	CTC-5J6572K	1X1-1X3271	137.73
	5J6572	I-SP-1	7	8-1/2	CTC-5J6572K		137.73
MODEL 769D, 771D							
HOIST	4T4168	I-SP-10	4,6-1/2	5-3/4	CTC-8T4772		205.11
	9J4149	I-SP-10	4,6-1/2	5-3/4	CTC-8T4772		205.11
STEERING	1100532	P-UB-10	2	3	CTC-7X2760		41.93
	9J1287	P-UB-10	2-3/8	3-3/4	CTC-7X2808		52.57
MODEL 771C							
HOIST	4T4168	I-SP-10	4,6-1/2	5-3/4	CTC-8T4772		205.11
	9J4149	I-SP-10	4,6-1/2	5-3/4	CTC-8T4772		205.11
STEERING	9J1287	P-UB-10	2-3/8	3-3/4	CTC-7X2808		52.57
MODEL 773							
STEERING	7J7686	P-UB-10	2-3/8	4	CTC-8T1389	63G1-->, 63W1-->	31.03
SUSPENSION REAR	8J9332	I-SP-1	7	8-1/2	CTC-3G0688K	63W1725-->	137.73
	8J9332	I-SP-1	7	8-1/2	CTC-5J6572K	63G,63W1-63W1724	137.73
MODEL 773B							
HOIST	9J2017	I-SP-10	5,7-1/2	8-1/4	CTC-8T9042		296.80
	9T3122	I-SP-10	5,7-1/2	8-1/4	CTC-8T9042		296.80
SPECIAL APPLICATION	3G4640	P-UB-14	2-1/2	6	CTC-7X2669		152.43
STEERING RH	7J7686	P-UB-10	2-3/8	4	CTC-8T1389	63G1-->, 63W1-->	31.03
SUSPENSION REAR	8J9332	I-SP-1	7	8-1/2	CTC-3G0688K	63W1725-->	137.73
	8J9332	I-SP-1	7	8-1/2	CTC-5J6572K	63G,63W1-63W1724	137.73
MODEL 773D, 775D							
HOIST	1455155	I-SP-10	5,7-1/2	8-1/4	CTC-8T9042		296.80
	9J2017	I-SP-10	5,7-1/2	8-1/4	CTC-8T9042		296.80
	9T3122	I-SP-10	5,7-1/2	8-1/4	CTC-8T9042		296.80
STEERING RH	7J7686	P-UB-10	2-3/8	4	CTC-8T1389		31.03

REPLACEMENT KITS FOR CATERPILLAR® EQUIPMENT

Off-Highway Trucks							
APPLICATION	CYL #	CODE	ROD	BORE	KIT #	Misc-Serial #'s, Parts, etc.	List \$
MODEL 775							
HOIST	9J2017	I-SP-10	5,7-1/2	8-1/4	CTC-8T9042		296.80
	9T3122	I-SP-10	5,7-1/2	8-1/4	CTC-8T9042		296.80
STEERING RH	7J7686	P-UB-10	2-3/8	4	CTC-8T1389		31.03
MODEL 776B							
STEERING	8J9912	P-UB-10	2-3/8	4	CTC-8T1389		31.03
SUSPENSION REAR	8J8865	I, P-U-13	9	10-1/2	CTC-1137482		232.80
MODEL 776C, 776D							
STEERING	8J9912	P-UB-10	2-3/8	4	CTC-8T1389		31.03
SUSPENSION REAR	8J8865	I, P-U-13	9	10-1/2	CTC-1137482		232.80
MODEL 777							
SPECIAL APPLICATION	3G4640	P-UB-14	2-1/2	6	CTC-7X2669		152.43
STEERING	8J9912	P-UB-10	2-3/8	4	CTC-8T1389	84A1-->,4YC1-->	31.03
SUSPENSION REAR	8J8865	I, P-U-13	9	10-1/2	CTC-1137482		232.80
	8J8865	I-SP-1	9	10-1/2	CTC-8J8902K	84A1-84A1283	311.22
	8J8865	I-SP-1	9	10-1/2	CTC-9T3972K	84A1284-->,4YC1-->	311.22
MODEL 777B							
STEERING	8J9912	P-UB-10	2-3/8	4	CTC-8T1389		31.03
SUSPENSION REAR	8J8865	I, P-U-13	9	10-1/2	CTC-1137482		232.80
	8J8865	I-SP-1	9	10-1/2	CTC-8J8902K	84A1-84A1283	311.22
	8J8865	I-SP-1	9	10-1/2	CTC-9T3972K	84A1284-->,4YC1-->	311.22
MODEL 777C							
STEERING	8J9912	P-UB-10	2-3/8	4	CTC-8T1389		31.03
SUSPENSION REAR	8J8865	I, P-U-13	9	10-1/2	CTC-1137482		232.80
MODEL 777D							
STEERING	8J9912	P-UB-10	2-3/8	4	CTC-8T1389		31.03
SUSPENSION REAR	8J8865	I, P-U-13	9	10-1/2	CTC-1137482		232.80
MODEL 783B, 785, 785B, 785C							
FRONT SUSPENSION		I-U-3	11	13-1/8	BD-711436	Insert wiper kit	2057.46
		P-U-3	11	13-1/8	BD-712436	Press-in wiper kit	2111.32
		I, P-U-3	11	13-1/8	CTC-1137476	Combination kit	2140.00
HOIST		I-SP-10, 3	7-1/4, 10-1/2	9-1/4, 11-1/2	BD-715438	Includes extra parts	508.86
		I-SP-10, 3	7-1/4, 10-1/2	9-1/4, 11-1/2	CTC-8T4939		504.22
REAR SUSPENSION		I-U-3	11	12-1/2	BD-713437	Head# 1U4636	332.45
		P-U-3	11	12-1/2	BD-714437	Head# 1060856, 1072858	386.32
		I, P-U-3	11	12-1/2	CTC-1565209	Head# 1U4636, 1060856, 1072858	415.01
STEERING		P-UB-10	2-1/2	5	CTC-1304012		124.78
		P-UB-10	2-1/2	5	CTC-7X2658	Serial# 8GB1-316	113.62
MODEL 784B, 784C							
REAR SUSPENSION		I-U-3	11	12-1/2	BD-713437	Head# 1U4636	332.45
		P-U-3	11	12-1/2	BD-714437	Head# 1060856, 1072858	386.32
		I, P-U-3	11	12-1/2	CTC-1565209	Head# 1U4636, 1060856, 1072858	415.01
MODEL 786							
STEERING	7J9718	P-UB-10	2-1/4	5	CTC-7X2729		105.87
	7J9984	P-UB-10	2-1/4	5	CTC-7X2729		105.87
TILT LH	7J9762	P-UB-10	2-3/4	6-1/2	CTC-7X2689		105.00
TILT RH	7J9761	P-UB-10	2-3/4	6-1/2	CTC-7X2689		105.00

REPLACEMENT KITS FOR CATERPILLAR® EQUIPMENT

Off-Highway Trucks							
APPLICATION	CYL #	CODE	ROD	BORE	KIT #	Misc-Serial #'s, Parts, etc.	List \$
MODEL 789, 789B, 789C							
FRONT SUSPENSION		I-U-3	12-1/2	15-1/8	BD-717440	Insert wiper kit	2320.25
		P-U-3	12-1/2	15-1/8	BD-718440	Press-in wiper kit	2230.15
HOIST		I, P-U-3	12-1/2	15-1/8	CTC-1131073	Combination kit	2406.51
		I-SP-10, 3	7-1/4, 11	9-1/2, 12-1/4	BD-716439		640.38
		I-SP-10, 3	7-1/4, 11	9-1/2, 12-1/4	CTC-8C5788	Includes rod wear rings	789.25
REAR SUSPENSION		I-U-3	12-1/2	14-1/4	BD-719441	Head# 4T4761	505.46
		P-U-3	12-1/2	14-1/4	BD-720441	Head# 1060904, 1061807, 1591977	415.33
		I, P-U-3	12-1/2	14-1/4	CTC-1137480	Head# 4T4761, 1060904, 1061807, 1591977	591.70
STEERING		P-UB-10	2-3/4	6	CTC-7X2680		89.33
MODEL 793, 793B							
FRONT SUSPENSION		I-U-3	13-1/2	16-1/8	BD-7751023	Insert wiper kit	2340.32
		P-U-3	13-1/2	16-1/8	BD-7761023	Press-in wiper kit	2383.07
		I, P-U-3	13-1/2	16-1/8	CTC-1137472	Combination kit	2428.85
HOIST		I-SP-10, 3	8-3/4, 12-1/2	11, 13-3/4	CTC-1125343		743.34
REAR SUSPENSION		I-U-3	12-1/2	14-1/4	BD-719441	Head# 4T4761	505.46
		P-U-3	12-1/2	14-1/4	BD-720441	Head# 1060904, 1061807, 1591977	415.33
		P-U-3	12-1/2	14-1/4	BD-778441	Head# 1946859; kit includes rod wear ring	1019.04
		I, P-U-3	12-1/2	14-1/4	CTC-1137480	Head# 4T4761, 1060904, 1061807, 1591977	591.70
STEERING		P-UB-10	2-3/4	5-1/2	CTC-1570287		96.92
MODEL 793C							
FRONT SUSPENSION		I-U-3	13-1/2	16-1/8	BD-7751023	Insert wiper kit	2340.32
		P-U-3	13-1/2	16-1/8	BD-7761023	Press-in wiper kit	2383.07
		I, P-U-3	13-1/2	16-1/8	CTC-1137472	Combination kit	2428.85
HOIST		I-SP-10, 3	7-3/4, 11-1/2	10, 12-1/2	CTC-1531282		546.43
REAR SUSPENSION		I-U-3	12-1/2	14-1/4	BD-719441	Head# 4T4761	505.46
		P-U-3	12-1/2	14-1/4	BD-720441	Head# 1060904, 1061807, 1591977	415.33
		I, P-U-3	12-1/2	14-1/4	CTC-1137480	Head# 4T4761, 1060904, 1061807, 1591977	591.70
STEERING		P-UB-10	2-3/4	5-1/2	CTC-1570287		96.92
Pipelayers							
APPLICATION	CYL #	CODE	ROD	BORE	KIT #	Misc-Serial #'s, Parts, etc.	List \$
MODEL 561B							
COUNTERWEIGHT LH	3G3504	P-UB-10	2	4-1/2	CTC-7X2768		57.83
COUNTERWEIGHT RH	3G3505	P-UB-10	2	4-1/2	CTC-7X2768		57.83
MODEL 561C, 561D							
COUNTERWEIGHT LH	3G3504	P-UB-10	2	4-1/2	CTC-7X2768		57.83
COUNTERWEIGHT RH	3G3505	P-UB-10	2	4-1/2	CTC-7X2768		57.83
TRACK ADJUSTER		TRK ADJ			CTC-FIG4400		31.32
MODEL 571A, 571F, 571G							
TRACK ADJUSTER		TRK ADJ			CTC-FIG3401		36.41
MODEL 572C, 572D, 572E, 572F							
TRACK ADJUSTER		TRK ADJ			CTC-FIG2400		50.09
		TRK ADJ			CTC-FIG3401		36.41

REPLACEMENT KITS FOR CATERPILLAR® EQUIPMENT

CATERPILLAR®

Pipelayers							
APPLICATION	CYL #	CODE	ROD	BORE	KIT #	Misc-Serial #'s, Parts, etc.	List \$
MODEL 572G							
DOZER LIFT LH	1U2136	P-UB-10	2-1/2	4-3/4	CTC-7X2660		117.13
DOZER LIFT RH	1U2135	P-UB-10	2-1/2	4-3/4	CTC-7X2660		117.13
TRACK ADJUSTER		TRK ADJ			CTC-FIG2400		50.09
		TRK ADJ			CTC-FIG3401		36.41
MODEL 578							
COUNTERWEIGHT	3G2918	P-V-10	2	4-1/2	CTC-7X2700		46.27
	9T0489	P-V-10	2	4-1/2	CTC-7X2700		46.27
MODEL 583H, 583K							
SIDE DUMP	8J5670	P-UB-10	2	4	CTC-7X2755		89.10
	8J5670	P-UB-10	2	4	CTC-7X7937		97.17
TRACK ADJUSTER		TRK ADJ			CTC-FIG1401		53.75
		TRK ADJ			CTC-FIG1402		78.64
MODEL 583R							
COUNTERWEIGHT	1333850	P-UB-10	2-1/8	4	CTC-1305923		103.38
MODEL 589							
COUNTERWEIGHT	3G2918	P-V-10	2	4-1/2	CTC-7X2700		46.27
MODEL 591							
COUNTERWEIGHT	3G9729	P-V-10	2	4-1/2	CTC-7X2700		46.27
MODEL 594, 594H							
LIFT	6J0416	P-V-10	2	5	CTC-7X2763		88.32
TRACK ADJUSTER		TRK ADJ			CTC-FIG0401		61.14
		TRK ADJ			CTC-FIG0402		72.03
MODEL MD7, MD8, MDW8							
COUNTERWEIGHT	3G3505	P-UB-10	2	4-1/2	CTC-7X2768		57.83
Scrapers							
APPLICATION	CYL #	CODE	ROD	BORE	KIT #	Misc-Serial #'s, Parts, etc.	List \$
MODEL 611							
BOWL	3G5679	P-UB-10	2-1/4	5	CTC-9X6392		104.34
LOAD	3G7274	P-UB-10	2-1/4	4-3/4	CTC-1318778		102.92
STEERING	6E3566	P-UB-10	2-1/4	4-1/2	CTC-1354392		101.01
MODEL 613							
BOWL LIFT	7J6058	P-UB-10	2	4	CTC-7X2755		89.10
EJECTOR	1U2012	P-UB-10	2-1/4	3-1/2	CTC-7X2818		58.83
FLOOR	7J5528	P-UB-10	2-1/2	5	CTC-7X2675		81.02
STEERING	7J6054	P-UB-10	2	4	CTC-7X2755		89.10
MODEL 613B							
BOWL LIFT	7J6058	P-UB-10	2	4	CTC-7X2755		89.10
EJECTOR	1U2012	P-UB-10	2-1/4	3-1/2	CTC-7X2818		58.83
FLOOR	7J5528	P-UB-10	2-1/2	5	CTC-7X2675		81.02
STEERING	1U2291	P-UB-10	2	4	CTC-1328816		60.48
	6E2968	P-UB-10	2	3-1/2	CTC-7X2783		67.15
	7J6054	P-UB-10	2	4	CTC-7X2755		89.10
	9T7900	P-UB-10	2	4	CTC-1328816		60.48
MODEL 613C							
BOWL LIFT	1U3124	P-UB-10	2	4	CTC-7X2789		66.51
EJECTOR	1U2012	P-UB-10	2-1/4	3-1/2	CTC-7X2818		58.83
FLOOR	1U2157	P-UB-10	2-1/2	5	CTC-7X2658		113.62
STEERING	1U2291	P-UB-10	2	4	CTC-7X2789		66.51

REPLACEMENT KITS FOR CATERPILLAR® EQUIPMENT

Scrapers							
APPLICATION	CYL #	CODE	ROD	BORE	KIT #	Misc-Serial #'s, Parts, etc.	List \$
MODEL 613SC							
BOWL	1U3124	P-UB-10	2	4	CTC-1328816		60.48
	3G5679	P-UB-10	2-1/4	5	CTC-9X6392		104.34
	7J6058	P-UB-10	2	4	CTC-7X2755		89.10
	9T8252	P-UB-10	2	4	CTC-1328816		60.48
EJECTOR	1U2012	P-UB-10	2-1/4	3-1/2	CTC-1358166		111.84
FLOOR	1U2157	P-UB-10	2-1/2	5	CTC-1315118		116.00
MODEL 615							
BOWL	3G5679	P-UB-10	2-1/4	5	CTC-9X6392		104.34
CUSHION HITCH	3G7274	P-UB-10	2-1/4	4-3/4	CTC-8T2216		51.29
DOOR	3G3883	P-UB-10	2-3/4	5-1/2	CTC-7X2690		64.91
EJECTOR	3G3892	P-UB-10	2-1/2	4-1/4	CTC-7X2663		32.21
LOAD	3G7274	P-UB-10	2-1/4	4-3/4	CTC-1318778		102.92
STEERING	5J1326	P-UB-10	2-1/4	5	CTC-7X2729		105.87
MODEL 615C							
BOWL LIFT	3G5679	P-UB-10	2-1/4	5	CTC-7X2729		105.87
DOOR	3G3883	P-UB-10	2-3/4	5-1/2	CTC-7X2690		64.91
EJECTOR	3G3892	P-UB-10	2-1/2	4-1/4	CTC-7X2663		32.21
LIFT	7J9902	P-UB-10	2	4-1/4	CTC-7X2819		68.55
LOAD	3G7274	P-UB-10	2-1/4	4-3/4	CTC-1318778		102.92
STEERING	5J1326	P-UB-10	2-1/4	5	CTC-7X2729		105.87
	6E2968	P-UB-10	2	3-1/2	CTC-7X2783		67.15
	6E3566	P-UB-10	2-1/4	4-1/2	CTC-1354392		101.01
MODEL 615SC							
BOWL	3G5679	P-UB-10	2-1/4	5	CTC-7X2729		105.87
	3G5679	P-UB-10	2-1/4	5	CTC-9X6392		104.34
EJECTOR	3G3892	P-UB-10	2-1/2	4-1/4	CTC-7X2663		32.21
STEERING	5J1326	P-UB-10	2-1/4	5	CTC-7X2729		105.87
MODEL 621							
APRON	5J0778	P-UB-10	2-3/4	7-1/4	CTC-7X2681		74.08
BOWL LH	5J2450	P-UB-10	2-1/2	6	CTC-7X2662		111.69
BOWL RH	5J2449	P-UB-10	2-1/2	6	CTC-7X2662		111.69
EJECTOR	1U0408	P-UB-14	4	6-1/2	CTC-7X2765		153.70
	6J9689	P-UB-14	4	6-1/2	CTC-7X2765		153.70
FLOOR	7J5528	P-UB-10	2-1/2	5	CTC-7X2675		81.02
LOAD	8J0204	P-UB-10	2-1/2	5-1/2	CTC-9X2050		65.65
LOAD CUSHION HITCH	8J0204	P-UB-10	2-1/2	5-1/2	CTC-8T1374		60.89
	9J0537	P-UB-10	2-1/2	6-1/2	CTC-8T1376		51.87
	9J0537	P-SP-10	2-1/2	6-1/2	CTC-9X6024		100.06
	9T1803	P-UB-10	2-1/2	5-1/2	CTC-7X2653		105.93
	5J1326	P-UB-10	2-1/4	5	CTC-7X2729		105.87
STEERING	5J1326	P-UB-10	2-1/4	5	CTC-7X2729		105.87
MODEL 621B							
APRON	5J0778	P-UB-10	2-3/4	7-1/4	CTC-7X2681		74.08
BOWL LIFT	5J2449	P-UB-10	2-1/2	6	CTC-7X2662		111.69
	5J2450	P-UB-10	2-1/2	6	CTC-7X2662		111.69
EJECTOR	1U0408	P-UB-14	4	6-1/2	CTC-7X2765		153.70
	6J9573	P-UB-14	4	6-1/2	CTC-7X2765		153.70
LOAD	8J9446	P-UB-10	2-1/2	5-1/2	CTC-7X2653		105.93
	8J9446	P-UB-10	2-1/2	5-1/2	CTC-8T1374		60.89

REPLACEMENT KITS FOR CATERPILLAR® EQUIPMENT

Scrapers							
APPLICATION	CYL #	CODE	ROD	BORE	KIT #	Misc-Serial #'s, Parts, etc.	List \$
MODEL 621B							
LOAD	8J9446	P-UB-10	2-1/2	5-1/2	CTC-9X2050		65.65
STEERING	3G5192	P-UB-10	2-1/2	5	CTC-1304012		124.78
	5J1326	P-UB-10	2-1/4	5	CTC-7X2729		105.87
	8J7376	P-UB-10	2-1/2	5	CTC-1315106		110.14
MODEL 621E							
APRON	5J0778	P-UB-10	2-3/4	7-1/4	CTC-7X2681		74.08
BOWL LIFT	5J2449	P-UB-10	2-1/2	6	CTC-7X2662		111.69
	5J2450	P-UB-10	2-1/2	6	CTC-7X2662		111.69
EJECTOR	1U0408	P-UB-14	4	6-1/2	CTC-7X2765		153.70
	9T4885	P-UB-14	4	6-1/2	CTC-7X2765		153.70
LOAD	1083592	P-UB-10	2-1/2	5-1/2	CTC-7X2653		105.93
	9T1803	P-UB-10	2-1/2	5-1/2	CTC-7X2653		105.93
	9T1803	P-UB-10	2-1/2	5-1/2	CTC-8T1374		60.89
STEERING	3G5192	P-UB-10	2-1/2	5	CTC-7X2658		113.62
	4T9364	P-UB-10	2-1/4	5	CTC-7X2729		105.87
	5J1326	P-UB-10	2-1/4	5	CTC-7X2729		105.87
MODEL 621F							
LOAD	1083592	P-UB-10	2-1/2	5-1/2	CTC-7X2653		105.93
STEERING	3G5192	P-UB-10	2-1/2	5	CTC-1304012		124.78
	5J1326	P-UB-10	2-1/4	5	CTC-7X2729		105.87
MODEL 621G							
LOAD	1083592	P-UB-10	2-1/2	5-1/2	CTC-7X2653		105.93
MODEL 621R							
STEERING	3G5192	P-UB-10	2-1/2	5	CTC-1304012	1.11" wide wear ring, rod bearing incl	124.78
	3G5192	P-UB-10	2-1/2	5	CTC-7X2658	1.55" wide wear ring, rod bearing incl	113.62
	3G5192	P-UB-10	2-1/2	5	CTC-7X2743	1.55" Wide wear ring	73.25
MODEL 621S							
APRON	5J0778	P-UB-10	2-3/4	7-1/4	CTC-7X2681		74.08
	6E3690	P-UB-10	2-3/4	7-1/4	CTC-7X2681		74.08
BOWL LH	5J2450	P-UB-10	2-1/2	6	CTC-7X2662		111.69
BOWL RH	5J2449	P-UB-10	2-1/2	6	CTC-7X2662		111.69
EJECTOR	1U0408	P-UB-14	4	6-1/2	CTC-7X2765		153.70
STEERING	3G5192	P-UB-10	2-1/2	5	CTC-1304012		124.78
MODEL 621SC							
APRON	5J0778	P-UB-10	2-3/4	7-1/4	CTC-7X2681		74.08
	6E3690	P-UB-10	2-3/4	7-1/4	CTC-7X2681		74.08
BOWL LH	5J2450	P-UB-10	2-1/2	6	CTC-7X2662		111.69
BOWL RH	5J2449	P-UB-10	2-1/2	6	CTC-7X2662		111.69
EJECTOR	1U0408	P-UB-14	4	6-1/2	CTC-7X2765		153.70
	6J9689	P-UB-14	4	6-1/2	CTC-7X2765		153.70
	9T4885	P-UB-14	4	6-1/2	CTC-7X2765		153.70
LOAD	8J0204	P-UB-10	2-1/2	5-1/2	CTC-9X2050		65.65
STEERING	3G5192	P-UB-10	2-1/2	5	CTC-1304012		124.78
	3G5192	P-UB-10	2-1/2	5	CTC-7X2658		113.62
	3G5192	P-UB-10	2-1/2	5	CTC-7X2743		73.25
	5J1326	P-UB-10	2-1/4	5	CTC-7X2729		105.87

REPLACEMENT KITS FOR CATERPILLAR® EQUIPMENT

Scrapers							
APPLICATION	CYL #	CODE	ROD	BORE	KIT #	Misc-Serial #'s, Parts, etc.	List \$
MODEL 623							
EJECTOR	8J5478	P-UB-10	2-1/2	5	CTC-1304012		124.78
	8J5478	P-UB-10	2-1/2	5	CTC-7X2658		113.62
FLOOR	8J1821	P-UB-10	3	6	CTC-7X2698		121.48
LIFT	8J1876	P-UB-10	2-1/2	6	CTC-7X2662		111.69
LOAD	8J0204	P-UB-10	2-1/2	5-1/2	CTC-8T1374		60.89
	8J0204	P-UB-10	2-1/2	5-1/2	CTC-9X2050		65.65
	9J0537	P-UB-10	2-1/2	6-1/2	CTC-8T1376		51.87
	9J0537	P-SP-10	2-1/2	6-1/2	CTC-9X6024		100.06
	9T1803	P-UB-10	2-1/2	5-1/2	CTC-7X2653		105.93
STEERING	5J1326	P-UB-10	2-1/4	5	CTC-7X2729		105.87
MODEL 623B							
BOWL LIFT	8J1876	P-UB-10	2-1/2	6	CTC-7X2662		111.69
EJECTOR	8J5478	P-UB-10	2-1/2	5	CTC-7X2658		113.62
FLOOR	8J1821	P-UB-10	3	6	CTC-7X2698		121.48
LOAD	8J9446	P-UB-10	2-1/2	5-1/2	CTC-7X2653		105.93
	8J9446	P-UB-10	2-1/2	5-1/2	CTC-8T1374		60.89
STEERING	3G5192	P-UB-10	2-1/2	5	CTC-1304012		124.78
	3G5192	P-UB-10	2-1/2	5	CTC-7X2658		113.62
	3G5192	P-UB-10	2-1/2	5	CTC-7X2743		73.25
	8J7376	P-UB-10	2-1/2	5	CTC-1315106		110.14
WAGON DOOR	3G4640	P-UB-14	2-1/2	6	CTC-7X2669		152.43
MODEL 623E							
BOWL LIFT	8J1876	P-UB-10	2-1/2	6	CTC-7X2662		111.69
EJECTOR	8J5478	P-UB-10	2-1/2	5	CTC-7X2658		113.62
	9T4886	P-UB-10	4-1/2	6	CTC-8C6958		168.82
FLOOR	8J1821	P-UB-10	3	6	CTC-7X2698		121.48
LOAD	1083592	P-UB-10	2-1/2	5-1/2	CTC-7X2653		105.93
	9T1803	P-UB-10	2-1/2	5-1/2	CTC-7X2653		105.93
	9T1803	P-UB-10	2-1/2	5-1/2	CTC-8T1374		60.89
STEERING	3G5192	P-UB-10	2-1/2	5	CTC-7X2658		113.62
MODEL 623F, 623G							
LOAD	1083592	P-UB-10	2-1/2	5-1/2	CTC-7X2653		105.93
MODEL 623SC							
EJECTOR	8J5478	P-UB-10	2-1/2	5	CTC-1304012		124.78
	8J5478	P-UB-10	2-1/2	5	CTC-7X2658		113.62
FLOOR	8J1821	P-UB-10	3	6	CTC-7X2698		121.48
LIFT	8J1876	P-UB-10	2-1/2	6	CTC-7X2662		111.69
LOAD	8J0204	P-UB-10	2-1/2	5-1/2	CTC-9X2050		65.65
STEERING	3G5192	P-UB-10	2-1/2	5	CTC-1304012		124.78
	3G5192	P-UB-10	2-1/2	5	CTC-7X2658		113.62
	3G5192	P-UB-10	2-1/2	5	CTC-7X2743		73.25
	5J1326	P-UB-10	2-1/4	5	CTC-7X2729		105.87
MODEL 623SCG							
EJECTOR	8J5478	P-UB-10	2-1/2	5	CTC-1304012		124.78
LIFT	8J1876	P-UB-10	2-1/2	6	CTC-7X2662		111.69
STEERING	3G5192	P-UB-10	2-1/2	5	CTC-1304012		124.78
MODEL 627							
APRON	5J0778	P-UB-10	2-3/4	7-1/4	CTC-7X2681		74.08

REPLACEMENT KITS FOR CATERPILLAR® EQUIPMENT

Scrapers							
APPLICATION	CYL #	CODE	ROD	BORE	KIT #	Misc-Serial #'s, Parts, etc.	List \$
MODEL 627							
BAIL	4T5638	P-UB-10	1-3/4	3	CTC-7X2791		57.77
	8J6064	P-U-10	2	3-1/2	CTC-7X2806		79.11
BOWL LH	5J2450	P-UB-10	2-1/2	6	CTC-7X2662		111.69
BOWL RH	5J2449	P-UB-10	2-1/2	6	CTC-7X2662		111.69
EJECTOR	1U0408	P-UB-14	4	6-1/2	CTC-7X2765		153.70
LOAD	8J0204	P-UB-10	2-1/2	5-1/2	CTC-9X2050		65.65
LOAD CUSHION HITCH	8J0204	P-UB-10	2-1/2	5-1/2	CTC-8T1374		60.89
	9J0537	P-UB-10	2-1/2	6-1/2	CTC-8T1376		51.87
	9J0537	P-SP-10	2-1/2	6-1/2	CTC-9X6024		100.06
	9T1803	P-UB-10	2-1/2	5-1/2	CTC-7X2653		105.93
STEERING	5J1326	P-UB-10	2-1/4	5	CTC-7X2729		105.87
MODEL 627B							
APRON	5J0778	P-UB-10	2-3/4	7-1/4	CTC-7X2681		74.08
BAIL	8J6064	P-U-10	2	3-1/2	CTC-7X2806		79.11
	8J8458	P-UB-10	1-1/2	3-1/2	CTC-7X2752		62.21
BOWL LIFT	5J2449	P-UB-10	2-1/2	6	CTC-7X2662		111.69
	5J2450	P-UB-10	2-1/2	6	CTC-7X2662		111.69
EJECTOR	1U0408	P-UB-14	4	6-1/2	CTC-7X2765		153.70
	6J9573	P-UB-14	4	6-1/2	CTC-7X2765		153.70
LOAD	8J9446	P-UB-10	2-1/2	5-1/2	CTC-7X2653		105.93
	8J9446	P-UB-10	2-1/2	5-1/2	CTC-8T1374		60.89
STEERING	3G5192	P-UB-10	2-1/2	5	CTC-1304012		124.78
	3G5192	P-UB-10	2-1/2	5	CTC-7X2658		113.62
	3G5192	P-UB-10	2-1/2	5	CTC-7X2743		73.25
	5J1326	P-UB-10	2-1/4	5	CTC-7X2729		105.87
	8J7376	P-UB-10	2-1/2	5	CTC-1315106		110.14
MODEL 627E							
APRON	5J0778	P-UB-10	2-3/4	7-1/4	CTC-7X2681		74.08
BAIL	4T5638	P-UB-10	1-3/4	3	CTC-7X2791		57.77
BOWL LIFT	5J2449	P-UB-10	2-1/2	6	CTC-7X2662		111.69
	5J2450	P-UB-10	2-1/2	6	CTC-7X2662		111.69
EJECTOR	1U0408	P-UB-14	4	6-1/2	CTC-7X2765		153.70
	9T4885	P-UB-14	4	6-1/2	CTC-7X2765		153.70
LOAD	1083592	P-UB-10	2-1/2	5-1/2	CTC-7X2653		105.93
	9T1803	P-UB-10	2-1/2	5-1/2	CTC-7X2653		105.93
	9T1803	P-UB-10	2-1/2	5-1/2	CTC-8T1374		60.89
STEERING	3G5192	P-UB-10	2-1/2	5	CTC-7X2658		113.62
	3G6904	P-UB-10	2-1/2	5	CTC-7X2658		113.62
	5J1326	P-UB-10	2-1/4	5	CTC-7X2729		105.87
MODEL 627F							
BAIL	6E0801	P-UB-10	1-3/4	3	CTC-7X2825		32.51
LOAD	1083592	P-UB-10	2-1/2	5-1/2	CTC-7X2653		105.93
MODEL 627SC							
APRON	5J0778	P-UB-10	2-3/4	7-1/4	CTC-7X2681		74.08
	6E3690	P-UB-10	2-3/4	7-1/4	CTC-7X2681		74.08
BAIL	7J2377	P-U-10	2	3-1/2	CTC-7X2806		79.11
	8J6064	P-U-10	2	3-1/2	CTC-7X2806		79.11
BOWL LH	5J2450	P-UB-10	2-1/2	6	CTC-7X2662		111.69

REPLACEMENT KITS FOR CATERPILLAR® EQUIPMENT

Scrapers							
APPLICATION	CYL #	CODE	ROD	BORE	KIT #	Misc-Serial #'s, Parts, etc.	List \$
MODEL 627SC							
BOWL RH	5J2449	P-UB-10	2-1/2	6	CTC-7X2662		111.69
EJECTOR	1U0408	P-UB-14	4	6-1/2	CTC-7X2765		153.70
	9T4885	P-UB-14	4	6-1/2	CTC-7X2765		153.70
LOAD	8J0204	P-UB-10	2-1/2	5-1/2	CTC-9X2050		65.65
STEERING	3G5192	P-UB-10	2-1/2	5	CTC-1304012		124.78
	3G5192	P-UB-10	2-1/2	5	CTC-7X2658		113.62
	3G5192	P-UB-10	2-1/2	5	CTC-7X2743		73.25
	5J1326	P-UB-10	2-1/4	5	CTC-7X2729		105.87
MODEL 630							
TRACTION CONTROL	4D0470	P-V-10	2	5	CTC-7X2763		88.32
	4D5543	P-V-10	2	5	CTC-7X2763		88.32
MODEL 630B							
BOWL	6J1983	P-UB-10	3	6-1/4	CTC-7X2695		231.80
EJECTOR	6J1419	I-U-10	6	8-1/4	CTC-1180672		426.97
	6J1419	P-V-10	6	8-1/4	CTC-8T1415		192.92
MODEL 630SC							
EJECTOR	6J1419	I-U-10	6	8-1/4	CTC-1180672		426.97
MODEL 631							
APRON	8J5931	P-UB-10	3	6-1/4	CTC-7X2695		231.80
LIFT RH	7J2395	P-UB-10	2-3/4	7-1/4	CTC-7X2687		173.72
LOAD	8J9959	P-UB-10	2-1/2	6-1/2	CTC-8T1376		51.87
MODEL 631B							
BOWL LIFT	3G9677	P-UB-10	2-3/4	7-1/4	CTC-7X2687		173.72
	7J2395	P-UB-10	2-3/4	7-1/4	CTC-7X2687		173.72
	7J2396	P-UB-10	2-3/4	7-1/4	CTC-7X2687		173.72
EJECTOR	6J1419	I-U-10	6	8-1/4	CTC-1180672		426.97
	6J1419	P-V-10	6	8-1/4	CTC-8T1415		192.92
LIFT	3G9677	P-UB-10	2-3/4	7-1/4	CTC-7X2687		173.72
LOAD CUSHION HITCH	9J0537	P-UB-10	2-1/2	6-1/2	CTC-8T1376		51.87
	9J0537	P-SP-10	2-1/2	6-1/2	CTC-9X6024		100.06
STEERING	3J9031	P-UB-10	2-1/2	6-1/2	CTC-8T1376		51.87
	5J1250	P-UB-10	2-1/2	6-1/2	CTC-8T1376		51.87
	5J7806	P-UB-10	2-1/2	6-1/2	CTC-8T1376		51.87
	5J8606	P-UB-10	2-1/2	6-1/2	CTC-1370264		114.48
	8J3544	P-UB-10	2-1/2	6-1/2	CTC-8T1376		51.87
STEERING RH	7J1693	P-UB-10	2-1/2	6-1/2	CTC-8T1376		51.87
MODEL 631C							
APRON	8J5931	P-UB-10	3	6-1/4	CTC-7X2695		231.80
BOWL LIFT	7J2395	P-UB-10	2-3/4	7-1/4	CTC-7X2687		173.72
	7J2396	P-UB-10	2-3/4	7-1/4	CTC-7X2687		173.72
EJECTOR	6J1419	I-U-10	6	8-1/4	CTC-1180672		426.97
	6J1419	P-V-10	6	8-1/4	CTC-8T1415		192.92
LIFT LH	7J2396	P-UB-10	2-3/4	7-1/4	CTC-7X2687		173.72
LIFT RH	7J2395	P-UB-10	2-3/4	7-1/4	CTC-7X2687		173.72
LOAD	7J3386	P-UB-14	2-1/2	6	CTC-7X2836		167.54
	9J0537	P-UB-10	2-1/2	6-1/2	CTC-8T1376		51.87
	9J0537	P-SP-10	2-1/2	6-1/2	CTC-9X6024		100.06
STEERING	5J7806	P-UB-10	2-1/2	6-1/2	CTC-8T1376		51.87

REPLACEMENT KITS FOR CATERPILLAR® EQUIPMENT

Scrapers								
APPLICATION	CYL #	CODE	ROD	BORE	KIT #	Misc-Serial #'s, Parts, etc.	List \$	
MODEL 631D								
APRON	8J5931	P-UB-10	3	6-1/4	CTC-7X2695		231.80	
EJECTOR	6J1419	I-U-10	6	8-1/4	CTC-1180672		426.97	
	6J1419	P-V-10	6	8-1/4	CTC-8T1415		192.92	
	6J5824	P-V-10	6	8-1/4	CTC-8T1415		192.92	
	9J0409	P-UB-10	2-3/4	7-1/4	CTC-7X2687		173.72	
LIFT LH	9J0408	P-UB-10	2-3/4	7-1/4	CTC-7X2687		173.72	
LOAD	8J9959	P-UB-10	2-1/2	6-1/2	CTC-1370264		114.48	
	8J9959	P-UB-10	2-1/2	6-1/2	CTC-8T1376		51.87	
	8J9959	P-SP-10	2-1/2	6-1/2	CTC-9X6024		100.06	
STEERING	3G7607	P-UB-10	2-3/4	6-1/2	CTC-7X2689		105.00	
	8J9918	P-UB-10	2-3/4	6-1/2	CTC-7X2689		105.00	
MODEL 631E								
APRON	8J5931	P-UB-10	3	6-1/4	CTC-7X2695		231.80	
EJECTOR	6E0897	P-UB-10	3	6-1/4	CTC-7X2695		231.80	
	6J5824	P-V-10	6	8-1/4	CTC-8T1415		192.92	
	9T3595	I-U-10	6	8-1/4	CTC-1180672		426.97	
	9T3595	P-V-10	6	8-1/4	CTC-8T1415		192.92	
	9T4887	I-U-10	6	8-1/4	CTC-1180672		426.97	
	9T4887	P-V-10	6	8-1/4	CTC-8T1415		192.92	
	LIFT RH	9J0408	P-UB-10	2-3/4	7-1/4	CTC-7X2687		173.72
LOAD	8J9959	P-UB-10	2-1/2	6-1/2	CTC-1370264		114.48	
	8J9959	P-UB-10	2-1/2	6-1/2	CTC-8T1376		51.87	
	8J9959	P-SP-10	2-1/2	6-1/2	CTC-9X6024		100.06	
STEERING	3G7607	P-UB-10	2-3/4	6-1/2	CTC-7X2689		105.00	
	5J7806	P-UB-10	2-1/2	6-1/2	CTC-8T1376		51.87	
MODEL 631SC								
APRON	8J5931	P-UB-10	3	6-1/4	CTC-7X2695		231.80	
EJECTOR	6E0897	I-U-10	6	8-1/4	CTC-1180672		426.97	
	6E0905	I-U-10	6	8-1/4	CTC-1180672		426.97	
	6J1419	I-U-10	6	8-1/4	CTC-1180672		426.97	
	6J5824	I-U-10	6	8-1/4	CTC-1180672		426.97	
	6J5824	P-V-10	6	8-1/4	CTC-8T1415		192.92	
	9T3595	I-U-10	6	8-1/4	CTC-1180672		426.97	
	9T4887	I-U-10	6	8-1/4	CTC-1180672		426.97	
	LIFT LH	7J2396	P-UB-10	2-3/4	7-1/4	CTC-7X2687		173.72
		9J0409	P-UB-10	2-3/4	7-1/4	CTC-7X2687		173.72
LIFT RH	7J2395	P-UB-10	2-3/4	7-1/4	CTC-7X2687		173.72	
	9J0408	P-UB-10	2-3/4	7-1/4	CTC-7X2687		173.72	
LOAD	7J3386	P-UB-14	2-1/2	6	CTC-7X2836		167.54	
	9J0537	P-SP-10	2-1/2	6-1/2	CTC-9X6024		100.06	
STEERING	3G7607	P-UB-10	2-3/4	6-1/2	CTC-7X2689		105.00	
	3J9031	P-UB-10	2-1/2	6-1/2	CTC-8T1376		51.87	
	5J1250	P-UB-10	2-1/2	6-1/2	CTC-8T1376		51.87	
	5J7806	P-UB-10	2-1/2	6-1/2	CTC-8T1376		51.87	
MODEL 632								
BOWL LIFT	6J1983	P-UB-10	3	6-1/4	CTC-7X2695		231.80	
EJECTOR	6J1419	I-U-10	6	8-1/4	CTC-1180672		426.97	
	6J1419	P-V-10	6	8-1/4	CTC-8T1415		192.92	

REPLACEMENT KITS FOR CATERPILLAR® EQUIPMENT

Scrapers							
APPLICATION	CYL #	CODE	ROD	BORE	KIT #	Misc-Serial #'s, Parts, etc.	List \$
MODEL 632							
TRACTION CONTROL	4D0470	P-V-10	2	5	CTC-7X2763		88.32
	4D5543	P-V-10	2	5	CTC-7X2763		88.32
MODEL 633							
BOWL LIFT	3G9677	P-UB-10	2-3/4	7-1/4	CTC-7X2687		173.72
LIFT	3G9677	P-UB-10	2-3/4	7-1/4	CTC-7X2687		173.72
LOAD CUSHION HITCH	9J0537	P-UB-10	2-1/2	6-1/2	CTC-8T1376		51.87
	9J0537	P-SP-10	2-1/2	6-1/2	CTC-9X6024		100.06
STEERING	5J7806	P-UB-10	2-1/2	6-1/2	CTC-1370264		114.48
	5J7806	P-UB-10	2-1/2	6-1/2	CTC-8T1376		51.87
	8J3544	P-UB-10	2-1/2	6-1/2	CTC-8T1376		51.87
STEERING RH	7J1693	P-UB-10	2-1/2	6-1/2	CTC-8T1376		51.87
MODEL 633B							
BOWL LIFT	3G9677	P-UB-10	2-3/4	7-1/4	CTC-7X2687		173.72
LOAD CUSHION HITCH	9J0537	P-UB-10	2-1/2	6-1/2	CTC-8T1376		51.87
	9J0537	P-SP-10	2-1/2	6-1/2	CTC-9X6024		100.06
STEERING	5J7806	P-UB-10	2-1/2	6-1/2	CTC-8T1376		51.87
	6J1516	P-UB-10	2-1/2	6-1/2	CTC-8T1376		51.87
	8J3544	P-UB-10	2-1/2	6-1/2	CTC-8T1376		51.87
STEERING RH	7J1693	P-UB-10	2-1/2	6-1/2	CTC-8T1376		51.87
MODEL 633C							
BOWL LIFT	3G9677	P-UB-10	2-3/4	7-1/4	CTC-7X2687		173.72
LIFT	3G9677	P-UB-10	2-3/4	7-1/4	CTC-7X2687		173.72
LOAD	7J3386	P-UB-14	2-1/2	6	CTC-7X2836		167.54
	9J0537	P-UB-10	2-1/2	6-1/2	CTC-1370264		114.48
STEERING	9J0537	P-UB-10	2-1/2	6-1/2	CTC-8T1376		51.87
	9J0537	P-SP-10	2-1/2	6-1/2	CTC-9X6024		100.06
	5J7806	P-UB-10	2-1/2	6-1/2	CTC-1370264		114.48
	5J7806	P-UB-10	2-1/2	6-1/2	CTC-8T1376		51.87
	6J1516	P-UB-10	2-1/2	6-1/2	CTC-8T1376		51.87
	8J3544	P-UB-10	2-1/2	6-1/2	CTC-1370264		114.48
	8J3544	P-UB-10	2-1/2	6-1/2	CTC-8T1376		51.87
STEERING RH	7J1693	P-UB-10	2-1/2	6-1/2	CTC-8T1376		51.87
MODEL 633D							
BOWL LIFT	3G9677	P-UB-10	2-3/4	7-1/4	CTC-7X2687		173.72
	7J0243	P-UB-10	2-3/4	7-1/4	CTC-7X2687		173.72
EJECTOR	9T3595	I-U-10	6	8-1/4	CTC-1180672		426.97
	9T3595	P-V-10	6	8-1/4	CTC-8T1415		192.92
LOAD	8J9959	P-UB-10	2-1/2	6-1/2	CTC-1370264		114.48
	8J9959	P-UB-10	2-1/2	6-1/2	CTC-8T1376		51.87
	8J9959	P-SP-10	2-1/2	6-1/2	CTC-9X6024		100.06
STEERING	3G7607	P-UB-10	2-3/4	6-1/2	CTC-7X2689		105.00
	6J1516	P-UB-10	2-1/2	6-1/2	CTC-8T1376		51.87
	8J9918	P-UB-10	2-3/4	6-1/2	CTC-7X2689		105.00
STEERING RH	7J1693	P-UB-10	2-1/2	6-1/2	CTC-8T1376		51.87
MODEL 633SC							
BOWL	1313223	P-UB-10	2-3/4	7-1/4	CTC-7X2687		173.72
EJECTOR	1U0408	P-UB-14	4	6-1/2	CTC-7X2765		153.70
LIFT	3G9677	P-UB-10	2-3/4	7-1/4	CTC-7X2687		173.72

REPLACEMENT KITS FOR CATERPILLAR® EQUIPMENT

Scrapers							
APPLICATION	CYL #	CODE	ROD	BORE	KIT #	Misc-Serial #'s, Parts, etc.	List \$
MODEL 633SC							
LOAD	7J3386	P-UB-14	2-1/2	6	CTC-7X2836		167.54
	9J1188	P-SP-10	2-1/2	6-1/2	CTC-9X6024		100.06
STEERING	5J7806	P-UB-10	2-1/2	6-1/2	CTC-8T1376		51.87
	6J1516	P-UB-10	2-1/2	6-1/2	CTC-8T1376		51.87
	8J3544	P-UB-10	2-1/2	6-1/2	CTC-8T1376		51.87
STEERING RH	7J1693	P-UB-10	2-1/2	6-1/2	CTC-8T1376		51.87
MODEL 637							
APRON	8J5931	P-UB-10	3	6-1/4	CTC-7X2695		231.80
BAIL	4T5638	P-UB-10	1-3/4	3	CTC-7X2791		57.77
	7J2377	P-U-10	2	3-1/2	CTC-7X2806		79.11
	8J6064	P-U-10	2	3-1/2	CTC-7X2806		79.11
BOWL LIFT	7J2395	P-UB-10	2-3/4	7-1/4	CTC-7X2687		173.72
	7J2396	P-UB-10	2-3/4	7-1/4	CTC-7X2687		173.72
EJECTOR	6J5824	I-U-10	6	8-1/4	CTC-1180672		426.97
	6J5824	P-V-10	6	8-1/4	CTC-8T1415		192.92
LIFT LH	7J2396	P-UB-10	2-3/4	7-1/4	CTC-7X2687		173.72
LIFT RH	7J2395	P-UB-10	2-3/4	7-1/4	CTC-7X2687		173.72
LOAD	7J3386	P-UB-14	2-1/2	6	CTC-7X2836		167.54
	8J9959	P-UB-10	2-1/2	6-1/2	CTC-8T1376		51.87
	9J0537	P-UB-10	2-1/2	6-1/2	CTC-1370264		114.48
	9J0537	P-UB-10	2-1/2	6-1/2	CTC-8T1376		51.87
	9J0537	P-SP-10	2-1/2	6-1/2	CTC-9X6024		100.06
	5J7806	P-UB-10	2-1/2	6-1/2	CTC-1370264		114.48
STEERING	5J7806	P-UB-10	2-1/2	6-1/2	CTC-8T1376		51.87
MODEL 637B							
APRON	8J5931	P-UB-10	3	6-1/4	CTC-7X2695		231.80
BOWL LIFT	7J2395	P-UB-10	2-3/4	7-1/4	CTC-7X2687		173.72
	7J2396	P-UB-10	2-3/4	7-1/4	CTC-7X2687		173.72
EJECTOR	6J5824	P-V-10	6	8-1/4	CTC-8T1415		192.92
MODEL 637D							
APRON	8J5931	P-UB-10	3	6-1/4	CTC-7X2695		231.80
BAIL	8J6064	P-U-10	2	3-1/2	CTC-7X2806		79.11
	8J8458	P-UB-10	1-1/2	3-1/2	CTC-7X2752		62.21
EJECTOR	6J5824	P-V-10	6	8-1/4	CTC-8T1415		192.92
LIFT LH	9J0409	P-UB-10	2-3/4	7-1/4	CTC-7X2687		173.72
LIFT RH	9J0408	P-UB-10	2-3/4	7-1/4	CTC-7X2687		173.72
LOAD	8J9959	P-UB-10	2-1/2	6-1/2	CTC-1370264		114.48
	8J9959	P-UB-10	2-1/2	6-1/2	CTC-8T1376		51.87
	8J9959	P-SP-10	2-1/2	6-1/2	CTC-9X6024		100.06
STEERING	3G7607	P-UB-10	2-3/4	6-1/2	CTC-7X2689		105.00
	8J9918	P-UB-10	2-3/4	6-1/2	CTC-7X2689		105.00
MODEL 637E							
APRON	8J5931	P-UB-10	3	6-1/4	CTC-7X2695		231.80
BAIL	4T5638	P-UB-10	1-3/4	3	CTC-7X2791		57.77
EJECTOR	6J5824	P-V-10	6	8-1/4	CTC-8T1415		192.92
	9T3595	I-U-10	6	8-1/4	CTC-1180672		426.97
	9T3595	P-V-10	6	8-1/4	CTC-8T1415		192.92
	9T4887	I-U-10	6	8-1/4	CTC-1180672		426.97

REPLACEMENT KITS FOR CATERPILLAR® EQUIPMENT

Scrapers							
APPLICATION	CYL #	CODE	ROD	BORE	KIT #	Misc-Serial #'s, Parts, etc.	List \$
MODEL 637E							
EJECTOR	9T4887	P-V-10	6	8-1/4	CTC-8T1415		192.92
LIFT LH	9J0409	P-UB-10	2-3/4	7-1/4	CTC-7X2687		173.72
LIFT RH	9J0408	P-UB-10	2-3/4	7-1/4	CTC-7X2687		173.72
LOAD	8J9959	P-UB-10	2-1/2	6-1/2	CTC-1370264		114.48
	8J9959	P-UB-10	2-1/2	6-1/2	CTC-8T1376		51.87
	8J9959	P-SP-10	2-1/2	6-1/2	CTC-9X6024		100.06
STEERING	3G7607	P-UB-10	2-3/4	6-1/2	CTC-7X2689		105.00
MODEL 637SC							
APRON	8J5931	P-UB-10	3	6-1/4	CTC-7X2695		231.80
BAIL	7J2377	P-U-10	2	3-1/2	CTC-7X2806		79.11
	8J6064	P-U-10	2	3-1/2	CTC-7X2806		79.11
EJECTOR	6E0897	I-U-10	6	8-1/4	CTC-1180672		426.97
	6E0905	I-U-10	6	8-1/4	CTC-1180672		426.97
	6J5824	I-U-10	6	8-1/4	CTC-1180672		426.97
	6J5824	P-V-10	6	8-1/4	CTC-8T1415		192.92
	9T3595	I-U-10	6	8-1/4	CTC-1180672		426.97
	9T4887	I-U-10	6	8-1/4	CTC-1180672		426.97
	LIFT LH	7J2396	P-UB-10	2-3/4	7-1/4	CTC-7X2687	
9J0409		P-UB-10	2-3/4	7-1/4	CTC-7X2687		173.72
LIFT RH	7J2395	P-UB-10	2-3/4	7-1/4	CTC-7X2687		173.72
	9J0408	P-UB-10	2-3/4	7-1/4	CTC-7X2687		173.72
LOAD	7J3386	P-UB-14	2-1/2	6	CTC-7X2836		167.54
	9J0537	P-SP-10	2-1/2	6-1/2	CTC-9X6024		100.06
STEERING	3G7607	P-UB-10	2-3/4	6-1/2	CTC-7X2689		105.00
	5J7806	P-UB-10	2-1/2	6-1/2	CTC-8T1376		51.87
MODEL 639D							
BOWL LIFT	3G9677	P-UB-10	2-3/4	7-1/4	CTC-7X2687		173.72
EJECTOR	3G2949	P-UB-10	2-1/2	4-1/2	CTC-7X2667		62.30
LOAD	8J9959	P-UB-10	2-1/2	6-1/2	CTC-1370264		114.48
	8J9959	P-UB-10	2-1/2	6-1/2	CTC-8T1376		51.87
	8J9959	P-SP-10	2-1/2	6-1/2	CTC-9X6024		100.06
STEERING	3G7607	P-UB-10	2-3/4	6-1/2	CTC-7X2689		105.00
MODEL 639SC							
EJECTOR	3G2949	P-UB-10	2-1/2	4-1/2	CTC-7X2667		62.30
LIFT	3G9677	P-UB-10	2-3/4	7-1/4	CTC-7X2687		173.72
MODEL 641, 641B							
APRON	5J8117	P-UB-10	3-1/4	9-1/4	CTC-7X2708		132.90
BOWL LIFT	6J1983	P-UB-10	3	6-1/4	CTC-7X2695		231.80
BOWL LIFT LH	7J4364	P-UB-10	3	6-1/4	CTC-7X2695		231.80
BOWL LIFT RH	7J4363	P-UB-10	3	6-1/4	CTC-7X2695		231.80
CUSHION HITCH	7J4623	P-UB-10	3-1/2	8-1/4	CTC-7X2725		253.73
LOAD	5J8623	P-UB-10	3-1/2	8-1/4	CTC-7X2728		114.08
	7J4623	P-UB-10	3-1/2	8-1/4	CTC-7X2725	641B only	253.73
STEERING	3G9689	P-UB-10	2-3/4	7-1/4	CTC-7X2687		173.72
MODEL 641SC							
BOWL	6J1983	P-UB-10	3	6-1/4	CTC-7X2695		231.80
BOWL LH	7J4364	P-UB-10	3	6-1/4	CTC-7X2695		231.80
BOWL RH	7J4363	P-UB-10	3	6-1/4	CTC-7X2695		231.80

REPLACEMENT KITS FOR CATERPILLAR® EQUIPMENT

Scrapers							
APPLICATION	CYL #	CODE	ROD	BORE	KIT #	Misc-Serial #'s, Parts, etc.	List \$
MODEL 641SC							
LOAD	5J8623	P-UB-10	3-1/2	8-1/4	CTC-7X2728		114.08
	7J4623	P-UB-10	3-1/2	8-1/4	CTC-7X2725		253.73
MODEL 650, 650B							
BOWL LIFT LH	7J4356	P-UB-10	3-1/4	9-1/4	CTC-7X2716		104.07
	7J4406	P-UB-10	3-1/4	9-1/4	CTC-7X2716		104.07
BOWL LIFT RH	7J4355	P-UB-10	3-1/4	9-1/4	CTC-7X2716		104.07
	7J4405	P-UB-10	3-1/4	9-1/4	CTC-7X2716		104.07
SPECIAL APPLICATION	4J2064	P-UB-10	2-1/2	6	CTC-7X2679	650 only	90.10
	4J9996	P-UB-10	2-1/2	7-1/4	CTC-7X2661	650 only	117.98
MODEL 651							
APRON	5J8117	P-UB-10	3-1/4	9-1/4	CTC-7X2708		132.90
BOWL LIFT LH	7J4398	P-UB-10	3-1/4	9-1/4	CTC-7X2716		104.07
BOWL LIFT RH	7J4397	P-UB-10	3-1/4	9-1/4	CTC-7X2716		104.07
CUSHION HITCH	7J4623	P-UB-10	3-1/2	8-1/4	CTC-7X2725		253.73
LOAD	3G8757	P-UB-14	3-1/2	8-1/4	CTC-7X2724		132.50
	5J8623	P-UB-10	3-1/2	8-1/4	CTC-7X2728		114.08
STEERING	3G9689	P-UB-10	2-3/4	7-1/4	CTC-7X2687		173.72
	4T8563	P-UB-10	3-1/4	7-1/4	CTC-7X2718		129.55
MODEL 651B							
APRON	5J8117	P-UB-10	3-1/4	9-1/4	CTC-7X2708		132.90
BOWL LIFT LH	7J4398	P-UB-10	3-1/4	9-1/4	CTC-7X2716		104.07
BOWL LIFT RH	7J4397	P-UB-10	3-1/4	9-1/4	CTC-7X2716		104.07
CUSHION HITCH	7J4623	P-UB-10	3-1/2	8-1/4	CTC-7X2725		253.73
LOAD	5J8623	P-UB-10	3-1/2	8-1/4	CTC-7X2728		114.08
	7J4623	P-UB-10	3-1/2	8-1/4	CTC-7X2725		253.73
STEERING	3G9689	P-UB-10	2-3/4	7-1/4	CTC-7X2687		173.72
	5J8149	P-UB-10	2-3/4	7-1/4	CTC-7X2687		173.72
MODEL 651C							
APRON	5J8117	P-UB-10	3-1/4	9-1/4	CTC-7X2708		132.90
STEERING	3G9689	P-UB-10	2-3/4	7-1/4	CTC-7X2687		173.72
	5J8149	P-UB-10	2-3/4	7-1/4	CTC-7X2687		173.72
MODEL 651E							
APRON	3G8621	P-UB-10	3-1/4	9-1/4	CTC-7X2708		132.90
BOWL LIFT	4T5735	P-UB-10	3-1/4	9-1/4	CTC-7X2716		104.07
	4T5736	P-UB-10	3-1/4	9-1/4	CTC-7X2716		104.07
CUSHION HITCH	3G8757	P-UB-14	3-1/2	8-1/4	CTC-7X2724		132.50
LOAD	3G8757	P-UB-14	3-1/2	8-1/4	CTC-7X2724		132.50
STEERING	3G5516	P-UB-10	3-1/4	7-1/4	CTC-7X2718		129.55
	3G9689	P-UB-10	2-3/4	7-1/4	CTC-7X2687		173.72
	4T8563	P-UB-10	3-1/4	7-1/4	CTC-7X2718		129.55
MODEL 651SC							
APRON	3G8621	P-UB-10	3-1/4	9-1/4	CTC-7X2708		132.90
BOWL	7J4398	P-UB-10	3-1/4	9-1/4	CTC-7X2716		104.07
BOWL LH	4T5735	P-UB-10	3-1/4	9-1/4	CTC-7X2716		104.07
LOAD	5J8623	P-UB-10	3-1/2	8-1/4	CTC-7X2728		114.08
	7J4623	P-UB-10	3-1/2	8-1/4	CTC-7X2725		253.73
STEERING	4T8563	P-UB-10	3-1/4	7-1/4	CTC-7X2718		129.55

REPLACEMENT KITS FOR CATERPILLAR® EQUIPMENT

Scrapers							
APPLICATION	CYL #	CODE	ROD	BORE	KIT #	Misc-Serial #'s, Parts, etc.	List \$
MODEL 657							
APRON	5J8117	P-UB-10	3-1/4	9-1/4	CTC-7X2708		132.90
BAIL	4T5638	P-UB-10	1-3/4	3	CTC-7X2791		57.77
	7J2377	P-U-10	2	3-1/2	CTC-7X2806		79.11
	8J6064	P-U-10	2	3-1/2	CTC-7X2806		79.11
	8J8458	P-UB-10	1-1/2	3-1/2	CTC-7X2752		62.21
BOWL LIFT LH	7J4398	P-UB-10	3-1/4	9-1/4	CTC-7X2716		104.07
BOWL LIFT RH	7J4397	P-UB-10	3-1/4	9-1/4	CTC-7X2716		104.07
LOAD	3G8757	P-UB-14	3-1/2	8-1/4	CTC-7X2724		132.50
LOAD CUSHION	5J8623	P-UB-10	3-1/2	8-1/4	CTC-7X2725		253.73
	5J8623	P-UB-10	3-1/2	8-1/4	CTC-7X2728		114.08
	7J4623	P-UB-10	3-1/2	8-1/4	CTC-7X2725		253.73
STEERING	3G5516	P-UB-10	3-1/4	7-1/4	CTC-7X2718		129.55
	3G9689	P-UB-10	2-3/4	7-1/4	CTC-7X2687		173.72
	4T8563	P-UB-10	3-1/4	7-1/4	CTC-7X2718		129.55
	5J8149	P-UB-10	2-3/4	7-1/4	CTC-7X2687		173.72
MODEL 657B							
APRON	5J4354	P-UB-10	3-1/4	9-1/4	CTC-7X2708		132.90
	5J8117	P-UB-10	3-1/4	9-1/4	CTC-7X2708		132.90
BAIL	7J2377	P-U-10	2	3-1/2	CTC-7X2806		79.11
	8J6064	P-U-10	2	3-1/2	CTC-7X2806		79.11
	8J8458	P-UB-10	1-1/2	3-1/2	CTC-7X2752		62.21
BOWL LIFT LH	7J4398	P-UB-10	3-1/4	9-1/4	CTC-7X2716		104.07
BOWL LIFT RH	7J4397	P-UB-10	3-1/4	9-1/4	CTC-7X2716		104.07
LOAD	5J8623	P-UB-10	3-1/2	8-1/4	CTC-7X2728		114.08
	7J4623	P-UB-10	3-1/2	8-1/4	CTC-7X2725		253.73
LOAD CUSHION	5J8623	P-UB-10	3-1/2	8-1/4	CTC-7X2725		253.73
	7J4623	P-UB-10	3-1/2	8-1/4	CTC-7X2725		253.73
STEERING	3G9689	P-UB-10	2-3/4	7-1/4	CTC-7X2687		173.72
	5J8149	P-UB-10	2-3/4	7-1/4	CTC-7X2687		173.72
MODEL 657E							
APRON	3G8621	P-UB-10	3-1/4	9-1/4	CTC-7X2708		132.90
BAIL	4T5638	P-UB-10	1-3/4	3	CTC-7X2791		57.77
	8J8458	P-UB-10	1-1/2	3-1/2	CTC-7X2752		62.21
BOWL LIFT	4T5735	P-UB-10	3-1/4	9-1/4	CTC-7X2716		104.07
	4T5736	P-UB-10	3-1/4	9-1/4	CTC-7X2716		104.07
CUSHION HITCH	3G8757	P-UB-14	3-1/2	8-1/4	CTC-7X2724		132.50
EJECTOR	9T4886	P-UB-10	4-1/2	6	CTC-8C6958		168.82
	9T4887	I-U-10	6	8-1/4	CTC-1180672		426.97
	9T4887	P-V-10	6	8-1/4	CTC-8T1415		192.92
LOAD	3G8757	P-UB-14	3-1/2	8-1/4	CTC-7X2724		132.50
STEERING	3G5516	P-UB-10	3-1/4	7-1/4	CTC-7X2718		129.55
	4T8563	P-UB-10	3-1/4	7-1/4	CTC-7X2718		129.55
MODEL 657SC							
APRON	3G8621	P-UB-10	3-1/4	9-1/4	CTC-7X2708		132.90
	5J8117	P-UB-10	3-1/4	9-1/4	CTC-7X2708		132.90
BAIL	7J2377	P-U-10	2	3-1/2	CTC-7X2806		79.11
	8J6062	P-U-10	2	3-1/2	CTC-7X2806		79.11
	8J8457	P-UB-10	1-1/2	3-1/2	CTC-7X2752		62.21

REPLACEMENT KITS FOR CATERPILLAR® EQUIPMENT

CATERPILLAR®

Scrapers							
APPLICATION	CYL #	CODE	ROD	BORE	KIT #	Misc-Serial #'s, Parts, etc.	List \$
MODEL 657SC							
BOWL	7J4398	P-UB-10	3-1/4	9-1/4	CTC-7X2716		104.07
BOWL LH	4T5735	P-UB-10	3-1/4	9-1/4	CTC-7X2716		104.07
BOWL RH	7J4397	P-UB-10	3-1/4	9-1/4	CTC-7X2716		104.07
LOAD	5J8623	P-UB-10	3-1/2	8-1/4	CTC-7X2728		114.08
	7J4623	P-UB-10	3-1/2	8-1/4	CTC-7X2725		253.73
STEERING	4T8563	P-UB-10	3-1/4	7-1/4	CTC-7X2718		129.55
MODEL 660, 666B							
BOWL LIFT LH	7J4356	P-UB-10	3-1/4	9-1/4	CTC-7X2716		104.07
BOWL LIFT RH	7J4355	P-UB-10	3-1/4	9-1/4	CTC-7X2716		104.07
SPECIAL APPLICATION	4J2064	P-UB-10	2-1/2	6	CTC-7X2679	660 only	90.10
MODEL 660B, 666							
BOWL LIFT LH	7J4356	P-UB-10	3-1/4	9-1/4	CTC-7X2716		104.07
	7J4406	P-UB-10	3-1/4	9-1/4	CTC-7X2716		104.07
BOWL LIFT RH	7J4355	P-UB-10	3-1/4	9-1/4	CTC-7X2716		104.07
	7J4405	P-UB-10	3-1/4	9-1/4	CTC-7X2716		104.07
SPECIAL APPLICATION	4J2064	P-UB-10	2-1/2	6	CTC-7X2679		90.10
	4J9996	P-UB-10	2-1/2	7-1/4	CTC-7X2661	666 only	117.98
MODEL 660SC, 666SC							
BOWL LH	7J4356	P-UB-10	3-1/4	9-1/4	CTC-7X2716		104.07
MODEL J621							
FLOOR	7J5528	P-UB-10	2-1/2	5	CTC-7X2675		81.02
Skidders							
APPLICATION	CYL #	CODE	ROD	BORE	KIT #	Misc-Serial #'s, Parts, etc.	List \$
MODEL 508							
BOOM	4T0863	P-UB-10	1-3/4	3-1/2	CTC-7X2784		36.73
GRAPPLE	4T0859	P-UB-10	2-1/4	4-1/2	CTC-7X2748		70.16
LIFT LH	4T9394	P-UB-10	1-1/2	3	CTC-7X2751		41.76
LIFT RH	4T0862	P-UB-10	1-1/2	3	CTC-7X2751		41.76
STEERING LH	4T0861	P-UB-10	1-1/2	3-1/4	CTC-7X2741		47.26
STEERING RH	4T0860	P-UB-10	1-1/2	3-1/4	CTC-7X2741		47.26
TONG	4T0859	P-UB-10	2-1/4	4-1/2	CTC-1326770		97.93
MODEL 515, 525							
LIFT	1117951	P-UB-10	2	4	CTC-1113302		77.57
	1397547	P-UB-10	2	4	CTC-1113302		77.57
MODEL 517							
ANGLING	1006174	P-UB-10	1-3/4	3-1/2	CTC-7X2784		36.73
LIFT	6E0365	P-UB-10	2	4-1/4	CTC-7X2819		68.55
TILT	9T9557	P-UB-10	2	4-1/4	CTC-1378662		88.25
MODEL 518							
LIFT	7J8925	P-UB-10	2	4	CTC-1328816		60.48
	9T1773	P-UB-10	2-1/2	5	CTC-1315118		116.00
STEERING LH	7J3350	P-UB-10	1-3/4	3	CTC-7X2825		32.51
STEERING RH	7J3349	P-UB-10	1-3/4	3	CTC-7X2825		32.51
TILT LH	9T1777	P-UB-10	2-1/4	4-1/4	CTC-7X2750		74.60
TILT RH	9T1772	P-UB-10	2-1/4	4-1/4	CTC-7X2750		74.60
MODEL 518C, 520D, 522C							
LIFT	1117951	P-UB-10	2	4	CTC-1113302		77.57
	1397547	P-UB-10	2	4	CTC-1113302		77.57

REPLACEMENT KITS FOR CATERPILLAR® EQUIPMENT

Skidders							
APPLICATION	CYL #	CODE	ROD	BORE	KIT #	Misc-Serial #'s, Parts, etc.	List \$
MODEL 518C, 520D, 522C							
LIFT	7J8925	P-UB-10	2	4	CTC-1328816	518C & 522C only	60.48
STEERING LH	7J3350	P-UB-10	1-3/4	3	CTC-7X2825		32.51
STEERING RH	7J3349	P-UB-10	1-3/4	3	CTC-7X2825		32.51
MODEL 520C							
LIFT	7J8925	P-UB-10	2	4	CTC-7X2789		66.51
STEERING RH	7J3349	P-UB-10	1-3/4	3	CTC-7X2791		57.77
MODEL 525B							
LIFT	1600492	P-UB-10	2-1/4	4	CTC-1546526		98.29
MODEL 527							
LIFT	1418640	P-UB-10	2-1/4	3-3/4	CTC-1361897		103.79
	1607610	P-UB-10	2-1/2	4-3/4	CTC-1328811		105.26
	6E0366	P-UB-10	2-1/2	4-3/4	CTC-1328811		105.26
MODEL 528							
DOZER LIFT	7J9902	P-UB-10	2	4-1/4	CTC-7X2819		68.55
STEERING LH	7J9234	P-UB-10	1-1/2	3-1/2	CTC-7X2752		62.21
STEERING RH	7J9233	P-UB-10	1-1/2	3-1/2	CTC-7X2752		62.21
MODEL 528B							
DOZER	7J9902	P-UB-10	2	4-1/4	CTC-7X2819		68.55
MODEL 530B							
DOZER	7J9902	P-UB-10	2	4-1/4	CTC-7X2819		68.55
LIFT	7J9902	P-UB-10	2	4-1/4	CTC-7X2819		68.55
MODEL 535B, 545							
LIFT	1600492	P-UB-10	2-1/4	4	CTC-1546526		98.29
MODEL FB508							
GRAPPLE	4T0860	P-UB-10	1-1/2	3-1/4	CTC-7X2741		47.26
	4T0861	P-UB-10	1-1/2	3-1/4	CTC-7X2741		47.26
	9T5924	P-UB-10	1-1/2	3-1/4	CTC-7X2741		47.26
MODEL FB518							
LIFT	9T1773	P-UB-10	2-1/2	5	CTC-7X2658		113.62
STEERING	7J3349	P-UB-10	1-3/4	3	CTC-7X2791		57.77
	7J3350	P-UB-10	1-3/4	3	CTC-7X2791		57.77
TILT LH	9T1777	P-UB-10	2-1/4	4-1/4	CTC-7X2750		74.60
TILT RH	9T1772	P-UB-10	2-1/4	4-1/4	CTC-7X2750		74.60
Soil Compactors							
APPLICATION	CYL #	CODE	ROD	BORE	KIT #	Misc-Serial #'s, Parts, etc.	List \$
MODEL 815							
LIFT	3G0881	P-UB-10	2	4	CTC-7X2789		66.51
	8J6809	P-UB-10	2	4	CTC-7X2755		89.10
	8J8756	P-UB-10	2	4	CTC-7X2789		66.51
LIFT RH	4J7859	P-UB-10	2	4	CTC-7X2755		89.10
STEERING	4T1574	P-UB-10	2	4	CTC-1328816		60.48
	4T1574	P-UB-10	2	4	CTC-7X2789		66.51
	7J6054	P-UB-10	2	4	CTC-7X2755		89.10
STEERING LH	7J9356	P-UB-10	2	4	CTC-7X2755		89.10
STEERING RH	7J9355	P-UB-10	2	4	CTC-7X2755		89.10
TILT	1U1988	P-UB-10	2	4	CTC-7X2755		89.10
MODEL 815B							
LIFT	3G0881	P-UB-10	2	4	CTC-1328816		60.48

REPLACEMENT KITS FOR CATERPILLAR® EQUIPMENT

Soil Compactors							
APPLICATION	CYL #	CODE	ROD	BORE	KIT #	Misc-Serial #'s, Parts, etc.	List \$
MODEL 815B							
LIFT	8J6809	P-UB-10	2	4	CTC-7X2755		89.10
STEERING	4T1574	P-UB-10	2	4	CTC-1328816		60.48
	6E5024	P-UB-10	2	4	CTC-1113302		77.57
TILT	1U1988	P-UB-10	2	4	CTC-7X2755		89.10
MODEL 815F							
LIFT	3G0881	P-UB-10	2	4	CTC-1328816		60.48
STEERING	4T1574	P-UB-10	2	4	CTC-1328816		60.48
	6E5024	P-UB-10	2	4	CTC-1113302		77.57
MODEL 815S							
TILT	1U1988	P-UB-10	2	4	CTC-7X2755		89.10
MODEL 825							
LIFT	8J2650	P-UB-10	2	4-1/2	CTC-7X2768		57.83
	9J7934	P-UB-10	2	4-1/2	CTC-7X2768		57.83
STEERING LH	9J7087	P-UB-10	2-1/4	5	CTC-7X2729		105.87
STEERING RH	9J7086	P-UB-10	2-1/4	5	CTC-7X2729		105.87
TILT	9J7951	P-UB-10	2	4-1/2	CTC-7X2768		57.83
MODEL 825B							
LIFT	4J9233	P-V-10	2	4-1/2	CTC-7X2770		63.86
	7J9818	P-UB-14	3	7-1/4	CTC-7X2699		140.39
	8J2650	P-UB-10	2	4-1/2	CTC-7X2768		57.83
	9J7934	P-UB-10	2	4-1/2	CTC-7X2768		57.83
STEERING	6J7590	P-UB-10	2-1/4	5	CTC-7X2729		105.87
	7J9718	P-UB-10	2-1/4	5	CTC-7X2729		105.87
	7K9401	P-UB-10	2-1/4	5	CTC-7X2729		105.87
STEERING LH	9J7087	P-UB-10	2-1/4	5	CTC-7X2729		105.87
STEERING RH	9J7086	P-UB-10	2-1/4	5	CTC-7X2729		105.87
TILT	9J7951	P-UB-10	2	4-1/2	CTC-7X2768		57.83
MODEL 825C							
LIFT	7J9818	P-UB-14	3	7-1/4	CTC-7X2699		140.39
	8J2650	P-UB-10	2	4-1/2	CTC-7X2768		57.83
	9J7934	P-UB-10	2	4-1/2	CTC-7X2768		57.83
STEERING LH	9J7087	P-UB-10	2-1/4	5	CTC-9X6392		104.34
STEERING RH	9J7086	P-UB-10	2-1/4	5	CTC-9X6392		104.34
TILT	9J7951	P-UB-10	2	4-1/2	CTC-7X2768		57.83
MODEL 825G							
LIFT	1199226	P-UB-10	2-1/4	3-3/4	CTC-1361897		103.79
	1447349	P-UB-10	2-1/4	3-3/4	CTC-1361897		103.79
	1493236	P-UB-10	2-1/4	3-3/4	CTC-1361897		103.79
STEERING	1175151	P-UB-10	2-1/2	4-1/2	CTC-1113300		89.05
TILT	1198863	P-UB-10	2	3-3/4	CTC-7X7938		68.22
MODEL 835							
LIFT	4J9233	P-V-10	2	4-1/2	CTC-7X2770		63.86
STEERING	7J9984	P-UB-10	2-1/4	5	CTC-7X2729		105.87
Telehandlers							
APPLICATION	CYL #	CODE	ROD	BORE	KIT #	Misc-Serial #'s, Parts, etc.	List \$
MODEL TH62, TH63, TH82, TH83							
N/A	9T4006	P-UB-10	1-1/2	3	CTC-7X2737		70.81

REPLACEMENT KITS FOR CATERPILLAR® EQUIPMENT

Track-Type Loaders							
APPLICATION	CYL #	CODE	ROD	BORE	KIT #	Misc-Serial #'s, Parts, etc.	List \$
MODEL 931							
BACKHOE BOOM	3G5767	P-UB-10	2-1/4	4-1/2	CTC-7X2748		70.16
	8J5555	P-UB-10	2-1/4	4-1/2	CTC-7X2748		70.16
BACKHOE BUCKET	3G5905	P-UB-10	2-1/4	3-1/2	CTC-7X2818		58.83
	8J5642	P-UB-10	2-1/4	3-1/2	CTC-7X2818		58.83
BACKHOE STABILIZER	1U2655	P-UB-10	2	4	CTC-1328816		60.48
	1U2656	P-UB-10	2	4	CTC-1328816		60.48
	3G6792	P-UB-10	1-1/2	3-1/2	CTC-7X2752		62.21
	8J6903	P-UB-10	2	4	CTC-1328816		60.48
	8J6904	P-UB-10	2	4	CTC-1328816		60.48
BACKHOE STICK	8J9481	P-UB-10	1-1/2	3-1/2	CTC-7X2752		62.21
	3G5771	P-UB-10	2	4	CTC-1328816		60.48
	8J5448	P-UB-10	2	4	CTC-1328816		60.48
LIFT	7J5893	P-UB-10	2	4	CTC-1328816		60.48
	7J5894	P-UB-10	2	4	CTC-1328816		60.48
M.P. BUCKET	3G7365	P-UB-10	1-1/2	3-1/2	CTC-7X2752		62.21
	8J5391	P-UB-10	1-1/2	3-1/2	CTC-7X2752		62.21
RIPPER	7J9920	P-UB-10	2	4	CTC-1328816		60.48
TILT	7J5885	P-UB-10	1-3/4	3	CTC-7X2791		57.77
	9J7905	P-UB-10	1-3/4	3	CTC-7X2791		57.77
MODEL 931B							
BACKHOE BOOM/BUCKET	3G5767	P-UB-10	2-1/4	4-1/2	CTC-1326770		97.93
	3G5905	P-UB-10	2-1/4	3-1/2	CTC-1358166		111.84
BACKHOE BUCKET	8J5642	P-UB-10	2-1/4	3-1/2	CTC-7X2818		58.83
BACKHOE STABILIZER	8J6903	P-UB-10	2	4	CTC-7X2789		66.51
	8J6904	P-UB-10	2	4	CTC-7X2789		66.51
	8J9481	P-UB-10	1-1/2	3-1/2	CTC-7X2752		62.21
BACKHOE STICK / BLADE SHIFT	3G5771	P-UB-10	2	4	CTC-1328816		60.48
LIFT	7J5893	P-UB-10	2	4	CTC-1328816		60.48
	7J5894	P-UB-10	2	4	CTC-1328816		60.48
LIFT LH	6E0214	P-UB-10	2	4	CTC-1328816		60.48
	9T6705	P-UB-10	2	4	CTC-1328816		60.48
LIFT RH	9T6704	P-UB-10	2	4	CTC-1328816		60.48
M.P. BUCKET	3G7365	P-UB-10	1-1/2	3-1/2	CTC-7X2752		62.21
RIPPER	7J9920	P-UB-10	2	4	CTC-1328816		60.48
STABILIZER	3G6792	P-UB-10	1-1/2	3-1/2	CTC-7X2752		62.21
	8J6903	P-UB-10	2	4	CTC-7X2789		66.51
	8J6904	P-UB-10	2	4	CTC-7X2789		66.51
	8J9481	P-UB-10	1-1/2	3-1/2	CTC-7X2752		62.21
	1U2656	P-UB-10	2	4	CTC-1328816		60.48
STABILIZER LH	1U2655	P-UB-10	2	4	CTC-1328816		60.48
STABILIZER RH	1U2655	P-UB-10	2	4	CTC-1328816		60.48
TILT	1U3165	P-UB-10	1-3/4	3-1/4	CTC-7X2764		41.63
	4T0963	P-UB-10	1-3/4	3-1/4	CTC-7X2764		41.63
	7J5885	P-UB-10	1-3/4	3	CTC-7X2791		57.77
	9J7905	P-UB-10	1-3/4	3	CTC-7X2791		57.77
MODEL 931C							
BACKHOE BOOM/BUCKET	3G5767	P-UB-10	2-1/4	4-1/2	CTC-1326770		97.93
	3G5767	P-UB-10	2-1/4	4-1/2	CTC-7X2748		70.16

REPLACEMENT KITS FOR CATERPILLAR® EQUIPMENT

CATERPILLAR®

Track-Type Loaders							
APPLICATION	CYL #	CODE	ROD	BORE	KIT #	Misc-Serial #'s, Parts, etc.	List \$
MODEL 931C							
BACKHOE BOOM/BUCKET	3G5905	P-UB-10	2-1/4	3-1/2	CTC-1358166		111.84
BACKHOE BUCKET	8J5642	P-UB-10	2-1/4	3-1/2	CTC-7X2818		58.83
BACKHOE STABILIZER	1U2655	P-UB-10	2	4	CTC-7X2789		66.51
	1U2656	P-UB-10	2	4	CTC-7X2789		66.51
	3G6792	P-UB-10	1-1/2	3-1/2	CTC-7X2752		62.21
	8J6903	P-UB-10	2	4	CTC-7X2789		66.51
	8J6904	P-UB-10	2	4	CTC-7X2789		66.51
	8J9481	P-UB-10	1-1/2	3-1/2	CTC-7X2752		62.21
	3G5771	P-UB-10	2	4	CTC-1328816		60.48
BACKHOE STICK / BLADE SHIFT							
BUCKET	3G7365	P-UB-10	1-1/2	3-1/2	CTC-7X2752		62.21
LIFT	7J5893	P-UB-10	2	4	CTC-1328816		60.48
	7J5894	P-UB-10	2	4	CTC-1328816		60.48
LIFT LH	6E0214	P-UB-10	2	4	CTC-1328816		60.48
	9T6705	P-UB-10	2	4	CTC-1328816		60.48
LIFT RH	9T6704	P-UB-10	2	4	CTC-1328816		60.48
M.P. BUCKET	3G7365	P-UB-10	1-1/2	3-1/2	CTC-7X2752		62.21
RIPPER	7J9920	P-UB-10	2	4	CTC-1328816		60.48
STABILIZER	3G6792	P-UB-10	1-1/2	3-1/2	CTC-7X2752		62.21
STABILIZER LH	1U2656	P-UB-10	2	4	CTC-1328816		60.48
STABILIZER RH	1U2655	P-UB-10	2	4	CTC-1328816		60.48
TILT	4T0963	P-UB-10	1-3/4	3-1/4	CTC-7X2764		41.63
MODEL 933							
BUCKET	3G7365	P-UB-10	1-1/2	3-1/2	CTC-7X2752		62.21
LIFT LH	1052808	P-UB-10	2	4	CTC-1328816		60.48
LIFT RH	1052886	P-UB-10	2	4	CTC-1328816		60.48
	6E0212	P-UB-10	2	4	CTC-1328816		60.48
RIPPER	7J9920	P-UB-10	2	4	CTC-1328816		60.48
TILT	1012493	P-UB-10	1-3/4	3-1/2	CTC-7X2784		36.73
	1368600	P-UB-10	1-3/4	3-1/2	CTC-7X2784		36.73
MODEL 933C							
BUCKET	1494362	P-UB-10	2	4	CTC-1328816		60.48
LIFT RH	1412421	P-UB-10	2	4	CTC-1328816		60.48
RIPPER	7J9920	P-UB-10	2	4	CTC-1328816		60.48
TILT	1214264	P-UB-10	1-3/4	3-1/2	CTC-7X2784		36.73
TRACK ADJUSTER		TRK ADJ			CTC-FIG4400		31.32
MODEL 933E, 933F, 933G							
TRACK ADJUSTER		TRK ADJ			CTC-FIG4400		31.32
MODEL 935B							
BACKHOE / BOOM BUCKET	3G5767	P-UB-10	2-1/4	4-1/2	CTC-1326770		97.93
	3G5905	P-UB-10	2-1/4	3-1/2	CTC-1358166		111.84
BACKHOE BUCKET	3G7365	P-UB-10	1-1/2	3-1/2	CTC-7X2752		62.21
BACKHOE STICK / BLADE SHIFT	3G5771	P-UB-10	2	4	CTC-1328816		60.48
LIFT	7J5893	P-UB-10	2	4	CTC-1328816		60.48
	7J5894	P-UB-10	2	4	CTC-1328816		60.48
LIFT LH	6E0214	P-UB-10	2	4	CTC-1328816		60.48
	9T6705	P-UB-10	2	4	CTC-1328816		60.48
LIFT RH	9T6704	P-UB-10	2	4	CTC-1328816		60.48

REPLACEMENT KITS FOR CATERPILLAR® EQUIPMENT

Track-Type Loaders							
APPLICATION	CYL #	CODE	ROD	BORE	KIT #	Misc-Serial #'s, Parts, etc.	List \$
MODEL 935B							
RIPPER	7J9920	P-UB-10	2	4	CTC-1328816		60.48
STABILIZER	3G6792	P-UB-10	1-1/2	3-1/2	CTC-7X2752		62.21
STABILIZER LH	1U2656	P-UB-10	2	4	CTC-1328816		60.48
STABILIZER RH	1U2655	P-UB-10	2	4	CTC-1328816		60.48
TILT	4T0963	P-UB-10	1-3/4	3-1/4	CTC-7X2764		41.63
MODEL 935C							
BACKHOE BOOM/BUCKET	3G5767	P-UB-10	2-1/4	4-1/2	CTC-1326770		97.93
	3G5905	P-UB-10	2-1/4	3-1/2	CTC-1358166		111.84
BACKHOE BUCKET	3G7365	P-UB-10	1-1/2	3-1/2	CTC-7X2752		62.21
BACKHOE STICK / BLADE SHIFT	3G5771	P-UB-10	2	4	CTC-1328816		60.48
LIFT	7J5893	P-UB-10	2	4	CTC-1328816		60.48
	7J5894	P-UB-10	2	4	CTC-1328816		60.48
LIFT LH	6E0214	P-UB-10	2	4	CTC-1328816		60.48
	9T6705	P-UB-10	2	4	CTC-1328816		60.48
LIFT RH	6E0212	P-UB-10	2	4	CTC-1328816		60.48
	9T6704	P-UB-10	2	4	CTC-1328816		60.48
RIPPER	7J9920	P-UB-10	2	4	CTC-1328816		60.48
STABILIZER	3G6792	P-UB-10	1-1/2	3-1/2	CTC-7X2752		62.21
STABILIZER LH	1U2656	P-UB-10	2	4	CTC-1328816		60.48
STABILIZER RH	1U2655	P-UB-10	2	4	CTC-1328816		60.48
TILT	4T0963	P-UB-10	1-3/4	3-1/4	CTC-7X2764		41.63
MODEL 939							
BUCKET	3G7365	P-UB-10	1-1/2	3-1/2	CTC-7X2752		62.21
LIFT LH	1052808	P-UB-10	2	4	CTC-1328816		60.48
LIFT RH	1052886	P-UB-10	2	4	CTC-1328816		60.48
	6E0212	P-UB-10	2	4	CTC-1328816		60.48
RIPPER	7J9920	P-UB-10	2	4	CTC-1328816		60.48
TILT	1012518	P-UB-10	2	4	CTC-1328816		60.48
	1363129	P-UB-10	2	4	CTC-1328816		60.48
MODEL 939C							
BUCKET	1494362	P-UB-10	2	4	CTC-1328816		60.48
LIFT	1412422	P-UB-10	2-1/2	4-1/2	CTC-1113300		89.05
RIPPER	7J9920	P-UB-10	2	4	CTC-1328816		60.48
TILT	1414266	P-UB-10	2	4	CTC-1328816		60.48
MODEL 941							
BUCKET	7J6789	P-UB-10	2	4	CTC-7X2789		66.51
	8J5663	P-UB-10	2	4	CTC-7X2789		66.51
BUCKET LH	6J2806	P-UB-10	2	4	CTC-7X2789		66.51
BUCKET RH	6J2805	P-UB-10	2	4	CTC-7X2789		66.51
LIFT	8J6868	P-UB-10	2-1/2	4	CTC-7X2659		102.22
LIFT LH	6J3082	P-UB-10	2-1/4	4	CTC-7X2802		59.79
	7J9862	P-UB-10	2-1/4	4	CTC-7X2802		59.79
	9J5726	P-UB-10	2-1/4	4	CTC-7X2802		59.79
LIFT RH	6J3081	P-UB-10	2-1/4	4	CTC-7X2802		59.79
	7J9861	P-UB-10	2-1/4	4	CTC-7X2802		59.79
	9J5725	P-UB-10	2-1/4	4	CTC-7X2802		59.79
RIPPER	6J3308	P-UB-10	2-1/2	5-1/2	CTC-8T1374		60.89

REPLACEMENT KITS FOR CATERPILLAR® EQUIPMENT

CATERPILLAR®

Track-Type Loaders							
APPLICATION	CYL #	CODE	ROD	BORE	KIT #	Misc-Serial #'s, Parts, etc.	List \$
MODEL 941							
RIPPER	6J3308	P-UB-10	2-1/2	5-1/2	CTC-9X2050		65.65
SIDE DUMP	8J5670	P-UB-10	2	4	CTC-7X2755		89.10
	8J5670	P-UB-10	2	4	CTC-7X7937		97.17
TILT LH	3G8085	P-UB-10	2-3/8	4	CTC-8T1389		31.03
	5J8028	P-UB-10	2-3/8	4	CTC-8T1389		31.03
TILT RH	7J9750	P-UB-10	2-3/8	4	CTC-8T1389		31.03
	7J9749	P-UB-10	2-3/8	4	CTC-8T1389		31.03
TRACK ADJUSTER		TRK ADJ			CTC-FIG4400		31.32
MODEL 941B							
BUCKET	7J6789	P-UB-10	2	4	CTC-7X2789		66.51
	8J5663	P-UB-10	2	4	CTC-7X2789		66.51
LIFT LH	6J3082	P-UB-10	2-1/4	4	CTC-7X2802		59.79
	7J9862	P-UB-10	2-1/4	4	CTC-7X2802		59.79
LIFT RH	9J5726	P-UB-10	2-1/4	4	CTC-7X2802		59.79
	6J3081	P-UB-10	2-1/4	4	CTC-7X2802		59.79
M.P. BUCKET	7J9861	P-UB-10	2-1/4	4	CTC-7X2802		59.79
	9J5725	P-UB-10	2-1/4	4	CTC-7X2802		59.79
M.P. BUCKET LH	8J5663	P-UB-10	2	4	CTC-7X2789		66.51
M.P. BUCKET RH	6J2806	P-UB-10	2	4	CTC-7X2789		66.51
RIPPER	6J2805	P-UB-10	2	4	CTC-7X2789		66.51
SIDE DUMP	6J3308	P-UB-10	2-1/2	5-1/2	CTC-8T1374		60.89
	6J3308	P-UB-10	2-1/2	5-1/2	CTC-9X2050		65.65
TILT LH	8J5670	P-UB-10	2	4	CTC-7X2755		89.10
	8J5670	P-UB-10	2	4	CTC-7X7937		97.17
TILT RH	3G8085	P-UB-10	2-3/8	4	CTC-8T1389		31.03
	5J8028	P-UB-10	2-3/8	4	CTC-8T1389		31.03
TRACK ADJUSTER	7J9750	P-UB-10	2-3/8	4	CTC-8T1389		31.03
	7J9749	P-UB-10	2-3/8	4	CTC-8T1389		31.03
TRACK ADJUSTER	8J5937	P-UB-10	2-3/8	4	CTC-8T1389		31.03
		TRK ADJ			CTC-FIG4400		31.32
MODEL 943							
BUCKET	4T9387	P-UB-10	2	4	CTC-1328816		60.48
	9J4892	P-UB-10	2	4	CTC-7X2789		66.51
BUCKET TILT	1U4802	P-UB-10	2-1/2	4-3/4	CTC-7X2660		117.13
LIFT	4T1963	P-UB-10	2-1/4	4	CTC-7X2795		68.83
	9J0532	P-UB-10	2-1/4	4	CTC-7X2795		68.83
M.P. BUCKET	9J4892	P-UB-10	2	4	CTC-7X2789		66.51
RIPPER	3G1296	P-UB-10	2	4	CTC-1328816		60.48
TILT	1U4802	P-UB-10	2-1/2	4-3/4	CTC-7X2660		117.13
	3G4653	P-UB-10	2-1/2	4-3/4	CTC-7X2660		117.13
MODEL 943B							
BUCKET	4T9387	P-UB-10	2	4	CTC-1328816		60.48
RIPPER	3G1296	P-UB-10	2	4	CTC-1328816		60.48
TILT	6E0257	P-UB-10	2-1/2	4-3/4	CTC-1328811		105.26
MODEL 951							
LIFT	7J9821	P-UB-10	2-1/4	4-1/4	CTC-7X2750		74.60
	7J9822	P-UB-10	2-1/4	4-1/4	CTC-7X2750		74.60

REPLACEMENT KITS FOR CATERPILLAR® EQUIPMENT

Track-Type Loaders							
APPLICATION	CYL #	CODE	ROD	BORE	KIT #	Misc-Serial #'s, Parts, etc.	List \$
MODEL 951							
LIFT	9J5728	P-UB-10	2-1/4	4-1/4	CTC-7X2750		74.60
LIFT RH	9J5727	P-UB-10	2-1/4	4-1/4	CTC-7X2750		74.60
LOG FORK LH	8J5677	P-V-10	2	5	CTC-7X2763		88.32
LOG FORK RH	8J5676	P-V-10	2	5	CTC-7X2763		88.32
M.P. BUCKET LH	6J2806	P-UB-10	2	4	CTC-7X2789		66.51
M.P. BUCKET RH	6J2805	P-UB-10	2	4	CTC-7X2789		66.51
RIPPER	6J3308	P-UB-10	2-1/2	5-1/2	CTC-8T1374		60.89
TILT	4T9387	P-UB-10	2	4	CTC-7X2789		66.51
	5J9815	P-UB-10	2-3/8	4-1/4	CTC-8T1464		34.95
	5J9816	P-UB-10	2-3/8	4-1/4	CTC-8T1464		34.95
	8J5939	P-UB-10	2-3/8	4-1/4	CTC-8T1464		34.95
TILT LH	2K3744	P-V-10	2	5	CTC-7X2763		88.32
	3G8083	P-UB-10	2-3/8	4-1/4	CTC-8T1464		34.95
TILT RH	2K3743	P-V-10	2	5	CTC-7X2763		88.32
	7J9833	P-UB-10	2-3/8	4-1/4	CTC-8T1464		34.95
TRACK ADJUSTER		TRK ADJ			CTC-FIG4400		31.32
MODEL 951B, 951C							
BUCKET	7J6789	P-UB-10	2	4	CTC-7X2789		66.51
	8J5663	P-UB-10	2	4	CTC-7X2789		66.51
BUCKET LH	6J2806	P-UB-10	2	4	CTC-7X2789		66.51
BUCKET RH	6J2805	P-UB-10	2	4	CTC-7X2789		66.51
LIFT LH	6J4014	P-UB-10	2-1/4	4-1/4	CTC-7X2750		74.60
	7J9822	P-UB-10	2-1/4	4-1/4	CTC-7X2750		74.60
	9J5728	P-UB-10	2-1/4	4-1/4	CTC-7X2750		74.60
LIFT RH	6J4013	P-UB-10	2-1/4	4-1/4	CTC-7X2750		74.60
	7J9821	P-UB-10	2-1/4	4-1/4	CTC-7X2750		74.60
	9J5727	P-UB-10	2-1/4	4-1/4	CTC-7X2750		74.60
RIPPER	6J3308	P-UB-10	2-1/2	5-1/2	CTC-9X2050		65.65
SIDE DUMP	8J5670	P-UB-10	2	4	CTC-7X2755		89.10
	8J5670	P-UB-10	2	4	CTC-7X7937		97.17
TILT	6J3308	P-UB-10	2-1/2	5-1/2	CTC-8T1374		60.89
	8J5939	P-UB-10	2-3/8	4-1/4	CTC-8T1464		34.95
TILT LH	3G8083	P-UB-10	2-3/8	4-1/4	CTC-8T1464		34.95
	5J9815	P-UB-10	2-3/8	4-1/4	CTC-8T1464		34.95
	5J9816	P-UB-10	2-3/8	4-1/4	CTC-8T1464		34.95
	7J9834	P-UB-10	2-3/8	4-1/4	CTC-8T1464		34.95
TILT RH	7J9833	P-UB-10	2-3/8	4-1/4	CTC-8T1464		34.95
	8J5939	P-UB-10	2-3/8	4-1/4	CTC-8T1464		34.95
TRACK ADJUSTER		TRK ADJ			CTC-FIG4400	951C only	31.32
MODEL 953							
BUCKET	4T9387	P-UB-10	2	4	CTC-1328816		60.48
	9J4892	P-UB-10	2	4	CTC-7X2789		66.51
LIFT	3G0717	P-UB-10	2-1/2	4-3/4	CTC-7X2660		117.13
	3G0717	P-UB-10	2-1/2	4-3/4	CTC-7X2773		116.33
	4T0263	P-UB-10	2-1/2	4-3/4	CTC-1328811		105.26
	4T0263	P-UB-10	2-1/2	4-3/4	CTC-7X2660		117.13
	4T0263	P-UB-10	2-1/2	4-3/4	CTC-7X2673		116.33
	4T2098	P-UB-10	2-1/2	4-3/4	CTC-1328811		105.26

REPLACEMENT KITS FOR CATERPILLAR® EQUIPMENT

Track-Type Loaders							
APPLICATION	CYL #	CODE	ROD	BORE	KIT #	Misc-Serial #'s, Parts, etc.	List \$
MODEL 953							
LIFT	4T2098	P-UB-10	2-1/2	4-3/4	CTC-7X2660		117.13
	4T2098	P-UB-10	2-1/2	4-3/4	CTC-7X2673		116.33
RIPPER	9T3625	P-UB-10	2-1/2	4-3/4	CTC-1361131	Rod Bearing width - 0.980"	107.38
	3G1296	P-UB-10	2	4	CTC-1328816		60.48
SIDE DUMP	9T0107	P-UB-10	2	4	CTC-7X2789		66.51
TILT	1U0418	P-UB-10	3	5-1/2	CTC-1281673		149.03
	4T1063	P-UB-10	2	4-1/4	CTC-7X2766		28.77
MODEL 953B							
BUCKET	4T9387	P-UB-10	2	4	CTC-1328816		60.48
LIFT	9T3625	P-UB-10	2-1/2	4-3/4	CTC-1361131	Rod Bearing width - 0.980"	107.38
RIPPER	3G1296	P-UB-10	2	4	CTC-1328816		60.48
TILT	1U0418	P-UB-10	3	5-1/2	CTC-1281673		149.03
MODEL 953C							
BUCKET	4T9387	P-UB-10	2	4	CTC-1328816		60.48
LIFT	9T3625	P-UB-10	2-1/2	4-3/4	CTC-1361131	Rod Bearing width - 0.980"	107.38
RIPPER	3G1296	P-UB-10	2	4	CTC-1328816		60.48
TILT	1U0418	P-UB-10	3	5-1/2	CTC-1281673		149.03
MODEL 955							
LIFT	5J6342	P-UB-10	2-1/2	5-1/2	CTC-9X2050		65.65
	7J1730	P-UB-10	2-1/2	5-1/2	CTC-9X2047		70.55
	7J9640	P-UB-10	2-1/2	5-1/2	CTC-9X2047		70.55
LIFT LH	9J2399	P-UB-10	2-1/2	5-1/2	CTC-9X2047		70.55
	9J2399	P-UB-10	2-1/2	5-1/2	CTC-9X2050		65.65
LIFT RH	9J2401	P-UB-10	2-1/2	5-1/2	CTC-9X2047		70.55
	9J2401	P-UB-10	2-1/2	5-1/2	CTC-9X2050		65.65
LOG FORK LH	8J5677	P-V-10	2	5	CTC-7X2763		88.32
LOG FORK RH	8J5676	P-V-10	2	5	CTC-7X2763		88.32
RIPPER	5J8190	P-UB-10	2-1/2	5-1/2	CTC-8T1374		60.89
TILT LH	2K3744	P-V-10	2	5	CTC-7X2763		88.32
	3G8081	P-UB-10	2-1/2	5	CTC-7X2658		113.62
TILT RH	2K3743	P-V-10	2	5	CTC-7X2763		88.32
	7J9637	P-UB-10	2-1/2	5	CTC-1304012		124.78
MODEL 955C							
BUCKET	7Y5100	P-UB-10	85 mm	130 mm	CTC-7Y5145		174.28
N/A	8J5676	P-V-10	2	5	CTC-7X2763		88.32
TRACK ADJUSTER		TRK ADJ			CTC-FIG4400		31.32
MODEL 955E							
BUCKET	7Y5100	P-UB-10	85 mm	130 mm	CTC-7Y5145		174.28
LOG FORK LH	8J5677	P-V-10	2	5	CTC-7X2763		88.32
LOG FORK RH	8J5676	P-V-10	2	5	CTC-7X2763		88.32
TRACK ADJUSTER		TRK ADJ			CTC-FIG4400		31.32
MODEL 955F							
TILT LH	2K3744	P-V-10	2	5	CTC-7X2763		88.32
TILT RH	2K3743	P-V-10	2	5	CTC-7X2763		88.32
TRACK ADJUSTER		TRK ADJ			CTC-FIG4400		31.32
MODEL 955H							
LOG FORK LH	8J5677	P-V-10	2	5	CTC-7X2763		88.32
LOG FORK RH	8J5676	P-V-10	2	5	CTC-7X2763		88.32

REPLACEMENT KITS FOR CATERPILLAR® EQUIPMENT

Track-Type Loaders							
APPLICATION	CYL #	CODE	ROD	BORE	KIT #	Misc-Serial #'s, Parts, etc.	List \$
MODEL 955H							
RIPPER	6J3308	P-UB-10	2-1/2	5-1/2	CTC-8T1374		60.89
	6J3308	P-UB-10	2-1/2	5-1/2	CTC-9X2050		65.65
TILT LH	2K3744	P-V-10	2	5	CTC-7X2763		88.32
TILT RH	2K3743	P-V-10	2	5	CTC-7X2763		88.32
TRACK ADJUSTER		TRK ADJ			CTC-FIG4400		31.32
MODEL 955K							
BUCKET LH	8J5704	P-V-10	2	4-1/2	CTC-1328783		48.68
BUCKET RH	8J5703	P-V-10	2	4-1/2	CTC-1328783		48.68
CLAMP	8J8498	P-V-10	2	4-1/2	CTC-1328783		48.68
LIFT	5J6342	P-UB-10	2-1/2	5-1/2	CTC-8T1374		60.89
	7J1730	P-UB-10	2-1/2	5-1/2	CTC-9X2047		70.55
	7J9640	P-UB-10	2-1/2	5-1/2	CTC-9X2047		70.55
LIFT LH	9J2399	P-UB-10	2-1/2	5-1/2	CTC-9X2050		65.65
LIFT RH	9J2401	P-UB-10	2-1/2	5-1/2	CTC-9X2050		65.65
RIPPER	5J8190	P-UB-10	2-1/2	5-1/2	CTC-8T1374		60.89
	5J8190	P-UB-10	2-1/2	5-1/2	CTC-9X2050		65.65
TILT	3G8081	P-UB-10	2-1/2	5	CTC-7X2658		113.62
TILT LH	5J6214	P-UB-10	2-1/2	5	CTC-1304012		124.78
	7J9638	P-UB-10	2-1/2	5	CTC-7X2658		113.62
TILT RH	5J6213	P-UB-10	2-1/2	5	CTC-1304012		124.78
	7J9637	P-UB-10	2-1/2	5	CTC-7X2658		113.62
TRACK ADJUSTER		TRK ADJ			CTC-FIG3400		39.00
		TRK ADJ			CTC-FIG4400		31.32
MODEL 955L							
BUCKET LH	8J5704	P-V-10	2	4-1/2	CTC-1328783		48.68
BUCKET RH	8J5703	P-V-10	2	4-1/2	CTC-1328783		48.68
CLAMP	8J8498	P-V-10	2	4-1/2	CTC-1328783		48.68
LIFT	5J6342	P-UB-10	2-1/2	5-1/2	CTC-8T1374		60.89
	7J1730	P-UB-10	2-1/2	5-1/2	CTC-9X2047		70.55
	7J9640	P-UB-10	2-1/2	5-1/2	CTC-9X2047		70.55
LIFT LH	9J2399	P-UB-10	2-1/2	5-1/2	CTC-9X2050		65.65
LIFT RH	9J2401	P-UB-10	2-1/2	5-1/2	CTC-9X2050		65.65
RIPPER	5J8190	P-UB-10	2-1/2	5-1/2	CTC-9X2050		65.65
TILT	3G8081	P-UB-10	2-1/2	5	CTC-7X2658		113.62
TILT LH	5J6214	P-UB-10	2-1/2	5	CTC-1304012		124.78
	7J9638	P-UB-10	2-1/2	5	CTC-7X2658		113.62
TILT RH	5J6213	P-UB-10	2-1/2	5	CTC-1304012		124.78
	7J9637	P-UB-10	2-1/2	5	CTC-7X2658		113.62
TRACK ADJUSTER		TRK ADJ			CTC-FIG3400		39.00
MODEL 963							
CLAMP	8J8498	P-V-10	2	4-1/2	CTC-1328783		48.68
DOZER TILT	4T1625	P-UB-10	2-1/4	4-3/4	CTC-7X2815		63.07
LIFT	4T0263	P-UB-10	2-1/2	4-3/4	CTC-1328811		105.26
	9J8002	P-UB-10	2-3/4	5-1/2	CTC-1327131		130.64
RIPPER	9J9881	P-UB-10	2-1/4	4-1/2	CTC-1326770		97.93
RIPPER LIFT	8J1779	P-UB-10	2-1/2	7-1/4	CTC-7X2661		117.98
RIPPER RH	1U3497	P-UB-10	2-1/4	4-1/2	CTC-1326770		97.93
TILT	3G3874	P-UB-10	3-3/4	6-1/2	CTC-7X2731		168.93

REPLACEMENT KITS FOR CATERPILLAR® EQUIPMENT

CATERPILLAR®

Track-Type Loaders							
APPLICATION	CYL #	CODE	ROD	BORE	KIT #	Misc-Serial #'s, Parts, etc.	List \$
MODEL 963							
TILT	4T1625	P-UB-10	2-1/4	4-3/4	CTC-7X2815		63.07
	9T1403	P-UB-10	3	6	CTC-7X2698		121.48
TRACK ADJUSTER		TRK ADJ			CTC-FIG3400		39.00
		TRK ADJ			CTC-FIG3401		36.41
MODEL 963B, 963C							
CLAMP	8J8498	P-V-10	2	4-1/2	CTC-1328783		48.68
LIFT	6E6632	P-UB-10	2-3/4	5-1/2	CTC-1570287		96.92
RIPPER	1228420	P-UB-10	2-1/4	4-1/2	CTC-1326770		97.93
RIPPER RH	1228421	P-UB-10	2-1/4	4-1/2	CTC-1326770		97.93
TILT	3G3874	P-UB-10	3-3/4	6-1/2	CTC-7X2731		168.93
MODEL 973							
BUCKET	9J1822	P-UB-10	2	5	CTC-7X2788		73.14
LIFT	3G0218	P-UB-10	3-1/4	6-1/2	CTC-7X2711		136.74
	4T2098	P-UB-10	2-1/2	4-3/4	CTC-1328811		105.26
RIPPER	3G1194	P-UB-10	2-1/2	5	CTC-1315106		110.14
	4T7606	P-UB-10	2-1/2	5	CTC-7X2658		113.62
RIPPER LIFT	4T7606	P-UB-10	2-1/2	5	CTC-7X2658		113.62
TILT	3G5949	P-UB-10	3-1/4	5-1/2	CTC-7X2712		60.42
	3G6571	P-UB-10	2-1/2	4-3/4	CTC-7X2773		116.33
TRACK ADJUSTER		TRK ADJ			CTC-FIG3400		39.00
		TRK ADJ			CTC-FIG3401		36.41
MODEL 973C							
BUCKET	9J1822	P-UB-10	2	5	CTC-7X2788		73.14
RIPPER	4T7606	P-UB-10	2-1/2	5	CTC-7X2658		113.62
TILT	3G5949	P-UB-10	3-1/4	5-1/2	CTC-7X2712		60.42
MODEL 977							
LIFT LH	7J9376	P-UB-10	2-3/4	6-1/2	CTC-9X2473		87.75
LIFT RH	7J9375	P-UB-10	2-3/4	6-1/2	CTC-9X2473		87.75
LIFT STEEL	3G8118	P-V-14	2-3/4	6-1/2	CTC-8T1554		89.83
LOG FORK	1K8206	P-V-10	2	5	CTC-7X2763		88.32
	8J5755	P-UB-10	2-1/4	5	CTC-7X2729		105.87
LOG FORK LH	8J5677	P-V-10	2	5	CTC-7X2763		88.32
LOG FORK RH	8J5676	P-V-10	2	5	CTC-7X2763		88.32
M.P. BUCKET	9J1822	P-UB-10	2	5	CTC-7X2788		73.14
	9J1822	P-V-10	2	5	CTC-7X2797		46.23
RIPPER	5J7686	P-UB-10	2-1/2	6-1/2	CTC-7X2666		110.77
TILT LH	9J0670	P-V-10	2-3/4	6	CTC-8T1553		73.67
	9J0673	P-UB-10	2-3/4	6	CTC-7X2803		111.76
TILT RH	9J0671	P-V-10	2-3/4	6	CTC-8T1553		73.67
	9J0672	P-UB-10	2-3/4	6	CTC-7X2803		111.76
TILT STEEL	3G8119	P-V-14	2-3/4	6-1/2	CTC-8T1554		89.83
MODEL 977D							
TRACK ADJUSTER		TRK ADJ			CTC-FIG3400		39.00
MODEL 977H							
M.P. BUCKET	8J5733	P-V-10	2	5	CTC-7X2763		88.32
RIPPER	2K3663	P-UB-10	2-1/2	7-1/4	CTC-7X2661		117.98
RIPPER LIFT	8J1779	P-UB-10	2-1/2	7-1/4	CTC-7X2661		117.98
TRACK ADJUSTER		TRK ADJ			CTC-FIG3400		39.00

REPLACEMENT KITS FOR CATERPILLAR® EQUIPMENT

CATERPILLAR®

Track-Type Loaders							
APPLICATION	CYL #	CODE	ROD	BORE	KIT #	Misc-Serial #'s, Parts, etc.	List \$
MODEL 977K							
BUCKET	8J5761	P-UB-10	2-1/2	5-1/2	CTC-9X2050		65.65
	9J1822	P-UB-10	2	5	CTC-7X2788		73.14
LIFT LH	3G8118	P-V-14	2-3/4	6-1/2	CTC-8T1554		89.83
	7J9376	P-UB-14	2-3/4	6-1/2	CTC-7X2686		78.72
LIFT RH	3G8119	P-V-14	2-3/4	6-1/2	CTC-8T1554		89.83
	7J9375	P-UB-14	2-3/4	6-1/2	CTC-7X2686		78.72
LOG FORK	8J5755	P-UB-10	2-1/4	5	CTC-7X2729		105.87
RIPPER	5J7686	P-UB-10	2-1/2	6-1/2	CTC-7X2666		110.77
SIDE DUMP	5J9893	P-UB-10	2-1/2	5	CTC-1315106		110.14
TILT	3G8119	P-V-14	2-3/4	6-1/2	CTC-8T1554		89.83
TILT BUCKET LH	8J5740	P-UB-10	2	5	CTC-7X2788		73.14
TILT BUCKET RH	8J5739	P-UB-10	2	5	CTC-7X2788		73.14
TILT LH	9J0670	P-V-10	2-3/4	6	CTC-8T1553		73.67
	9J0673	P-UB-10	2-3/4	6	CTC-7X2803		111.76
TILT RH	9J0671	P-V-10	2-3/4	6	CTC-8T1553		73.67
	9J0672	P-UB-10	2-3/4	6	CTC-7X2803		111.76
TRACK ADJUSTER		TRK ADJ			CTC-FIG3400		39.00
MODEL 977L							
BUCKET	8J5761	P-UB-10	2-1/2	5-1/2	CTC-9X2050		65.65
	9J1822	P-UB-10	2	5	CTC-7X2788		73.14
LIFT LH	3G8118	P-V-14	2-3/4	6-1/2	CTC-8T1554		89.83
	7J9376	P-UB-14	2-3/4	6-1/2	CTC-7X2686		78.72
LIFT RH	3G8119	P-V-14	2-3/4	6-1/2	CTC-8T1554		89.83
	7J9375	P-UB-14	2-3/4	6-1/2	CTC-7X2686		78.72
LOG FORK	8J5755	P-UB-10	2-1/4	5	CTC-7X2729		105.87
RIPPER	5J7686	P-UB-10	2-1/2	6-1/2	CTC-7X2666		110.77
SIDE DUMP	5J9893	P-UB-10	2-1/2	5	CTC-1315106		110.14
TILT BUCKET LH	8J5740	P-UB-10	2	5	CTC-7X2788		73.14
TILT BUCKET RH	8J5739	P-UB-10	2	5	CTC-7X2788		73.14
TILT LH	9J0670	P-V-10	2-3/4	6	CTC-8T1553		73.67
	9J0673	P-UB-10	2-3/4	6	CTC-7X2803		111.76
TILT RH	9J0671	P-V-10	2-3/4	6	CTC-8T1553		73.67
	9J0672	P-UB-10	2-3/4	6	CTC-7X2803		111.76
TRACK ADJUSTER		TRK ADJ			CTC-FIG3400		39.00
MODEL 983							
BUCKET CLAMP	8J5772	P-UB-14	2-1/2	6	CTC-7X2669		152.43
BUCKET DEMOLITION	8J5772	P-UB-14	2-1/2	6	CTC-7X2669		152.43
TRACK ADJUSTER		TRK ADJ			CTC-FIG2400		50.09
MODEL 983B							
TRACK ADJUSTER		TRK ADJ			CTC-FIG2400		50.09
Track-Type Tractors							
APPLICATION	CYL #	CODE	ROD	BORE	KIT #	Misc-Serial #'s, Parts, etc.	List \$
MODEL D2							
N/A	4H6711	P-V-10	1-1/4	4	CTC-8T1480		53.94
MODEL D3							
ANGLING	8J0096	P-UB-10	1-1/2	3-1/2	CTC-7X2752		62.21
	9J8698	P-UB-10	1-1/2	3-1/2	CTC-7X2752		62.21
	9J8761	P-UB-10	1-1/2	3-1/2	CTC-7X2752		62.21

REPLACEMENT KITS FOR CATERPILLAR® EQUIPMENT

Track-Type Tractors							
APPLICATION	CYL #	CODE	ROD	BORE	KIT #	Misc-Serial #'s, Parts, etc.	List \$
MODEL D3							
BACKHOE BOOM	8J5555	P-UB-10	2-1/4	4-1/2	CTC-7X2748		70.16
BACKHOE BUCKET	3G5905	P-UB-10	2-1/4	3-1/2	CTC-7X2818		58.83
	8J5642	P-UB-10	2-1/4	3-1/2	CTC-7X2818		58.83
BACKHOE STABILIZER	1U2655	P-UB-10	2	4	CTC-7X2789		66.51
	1U2656	P-UB-10	2	4	CTC-7X2789		66.51
	8J9481	P-UB-10	1-1/2	3-1/2	CTC-7X2752		62.21
BACKHOE STICK LIFT	8J5448	P-UB-10	2	4	CTC-7X2789		66.51
	7J9223	P-UB-10	1-1/2	3-1/2	CTC-7X2752		62.21
	7J9224	P-UB-10	1-1/2	3-1/2	CTC-7X2752		62.21
RIPPER	8J6894	P-UB-10	1-1/2	3-1/2	CTC-7X2752		62.21
	7J9920	P-UB-10	2	4	CTC-1328816		60.48
RIPPER PIN PULLER	4H6711	P-V-10	1-1/4	4	CTC-8T1480		53.94
TILT	8J0095	P-UB-10	1-1/2	3-1/2	CTC-7X2752		62.21
	8J6893	P-UB-10	2	4	CTC-7X2789		66.51
	9J4042	P-UB-10	1-1/2	3-1/2	CTC-7X2752		62.21
	9J8674	P-UB-10	1-1/2	3-1/2	CTC-7X2752		62.21
TRACK ADJUSTER		TRK ADJ			CTC-FIG4405		14.58
MODEL D3 LGP							
LIFT	8J6894	P-UB-10	1-1/2	3-1/2	CTC-7X2752		62.21
MODEL D3B							
ANGLING	9J8698	P-UB-10	1-1/2	3-1/2	CTC-1327058		67.73
	9J8761	P-UB-10	1-1/2	3-1/2	CTC-7X2752		62.21
BACKHOE BOOM/BUCKET	3G5767	P-UB-10	2-1/4	4-1/2	CTC-1326770		97.93
	3G5905	P-UB-10	2-1/4	3-1/2	CTC-1358166		111.84
BACKHOE STABILIZER	8J6903	P-UB-10	2	4	CTC-7X2789		66.51
	8J6904	P-UB-10	2	4	CTC-7X2789		66.51
	8J9481	P-UB-10	1-1/2	3-1/2	CTC-7X2752		62.21
BACKHOE STICK / BLADE SHIFT	3G5771	P-UB-10	2	4	CTC-1328816		60.48
LIFT	7J9223	P-UB-10	1-1/2	3-1/2	CTC-1327058		67.73
	8J6894	P-UB-10	1-1/2	3-1/2	CTC-7X2752		62.21
	9T4000	P-UB-10	1-1/2	4	CTC-7X2738		57.03
	9T6652	P-UB-10	1-1/2	3-1/2	CTC-1327058		67.73
	7J9920	P-UB-10	2	4	CTC-1328816		60.48
RIPPER	3G6792	P-UB-10	1-1/2	3-1/2	CTC-7X2752		62.21
STABILIZER	1U2656	P-UB-10	2	4	CTC-1328816		60.48
STABILIZER LH	1U2655	P-UB-10	2	4	CTC-1328816		60.48
STABILIZER RH							
TILT	8J0095	P-UB-10	1-1/2	3-1/2	CTC-7X2752		62.21
	8J6893	P-UB-10	2	4	CTC-1328816		60.48
	9J4042	P-UB-10	1-1/2	3-1/2	CTC-7X2752		62.21
	9J8674	P-UB-10	1-1/2	3-1/2	CTC-1327058		67.73
TRACK ADJUSTER		TRK ADJ			CTC-FIG4405		14.58
MODEL D3C							
ANGLING	1026237	P-UB-10	1-1/2	3-1/2	CTC-1327058		67.73
	1363155	P-UB-10	1-1/2	3-1/2	CTC-1327058		67.73
	1363156	P-UB-10	1-1/2	3-1/2	CTC-1327058		67.73
	1386859	P-UB-10	1-1/2	3	CTC-7X2751		41.76
	1390548	P-UB-10	1-1/2	3	CTC-7X2751		41.76

REPLACEMENT KITS FOR CATERPILLAR® EQUIPMENT



Track-Type Tractors							
APPLICATION	CYL #	CODE	ROD	BORE	KIT #	Misc-Serial #'s, Parts, etc.	List \$
MODEL D3C							
ANGLING	9J8698	P-UB-10	1-1/2	3-1/2	CTC-1327058		67.73
BACKHOE BOOM	3G5767	P-UB-10	2-1/4	4-1/2	CTC-7X2748		70.16
BACKHOE BUCKET	3G5905	P-UB-10	2-1/4	3-1/2	CTC-7X2818		58.83
BACKHOE STABILIZER	3G6792	P-UB-10	1-1/2	3-1/2	CTC-7X2752		62.21
BACKHOE STICK	3G5771	P-UB-10	2	4	CTC-7X2789		66.51
LIFT	1412915	P-UB-10	1-1/2	3-1/2	CTC-1327058		67.73
	7J9223	P-UB-10	1-1/2	3-1/2	CTC-1327058		67.73
	8J6894	P-UB-10	1-1/2	3-1/2	CTC-7X2752		62.21
LIFT RH	6E0212	P-UB-10	2	4	CTC-1328816		60.48
RIPPER	7J9920	P-UB-10	2	4	CTC-1328816		60.48
TILT	1437219	P-UB-10	1-1/2	3-1/2	CTC-1327058		67.73
	8J0095	P-UB-10	1-1/2	3-1/2	CTC-7X2752		62.21
	8J6893	P-UB-10	2	4	CTC-1328816		60.48
	9J4042	P-UB-10	1-1/2	3-1/2	CTC-7X2752		62.21
	9J8674	P-UB-10	1-1/2	3-1/2	CTC-1327058		67.73
TRACK ADJUSTER		TRK ADJ			CTC-FIG4405		14.58
MODEL D4B							
ANGLING	9J8698	P-UB-10	1-1/2	3-1/2	CTC-7X2752		62.21
BACKHOE BOOM/BUCKET	3G5767	P-UB-10	2-1/4	4-1/2	CTC-1326770		97.93
	3G5905	P-UB-10	2-1/4	3-1/2	CTC-1358166		111.84
BACKHOE STICK / BLADE SHIFT	3G5771	P-UB-10	2	4	CTC-1328816		60.48
LIFT	7J9223	P-UB-10	1-1/2	3-1/2	CTC-1327058		67.73
	9T6652	P-UB-10	1-1/2	3-1/2	CTC-1327058		67.73
RIPPER	7J9920	P-UB-10	2	4	CTC-1328816		60.48
STABILIZER	3G6792	P-UB-10	1-1/2	3-1/2	CTC-7X2752		62.21
STABILIZER LH	1U2656	P-UB-10	2	4	CTC-1328816		60.48
STABILIZER RH	1U2655	P-UB-10	2	4	CTC-1328816		60.48
TILT	9J8674	P-UB-10	1-1/2	3-1/2	CTC-1327058		67.73
TRACK ADJUSTER		TRK ADJ			CTC-FIG4405		14.58
MODEL D4C							
ANGLING	1363156	P-UB-10	1-1/2	3-1/2	CTC-1327058		67.73
	1390548	P-UB-10	1-1/2	3	CTC-7X2751		41.76
LIFT	9J8698	P-UB-10	1-1/2	3-1/2	CTC-1327058		67.73
	1412915	P-UB-10	1-1/2	3-1/2	CTC-1327058		67.73
	7J9223	P-UB-10	1-1/2	3-1/2	CTC-1327058		67.73
	8J6894	P-UB-10	1-1/2	3-1/2	CTC-7X2752		62.21
RIPPER	7J9920	P-UB-10	2	4	CTC-1328816		60.48
TILT	1437219	P-UB-10	1-1/2	3-1/2	CTC-1327058		67.73
	9J8674	P-UB-10	1-1/2	3-1/2	CTC-1327058		67.73
TRACK ADJUSTER		TRK ADJ			CTC-FIG4400		31.32
		TRK ADJ			CTC-FIG4405		14.58
MODEL D4D							
DOZER	4J4890	P-U-10	2	3-1/2	CTC-7X2806		79.11
	4J4891	P-U-10	2	3-1/2	CTC-7X2806		79.11
	4T4575	P-UB-10	2	3-1/2	CTC-7X2769		73.60
	5J1603	P-V-10	2	4-3/4	CTC-7X2677		76.32
DOZER LIFT	8J6894	P-UB-10	1-1/2	3-1/2	CTC-7X2752		62.21

REPLACEMENT KITS FOR CATERPILLAR® EQUIPMENT

Track-Type Tractors							
APPLICATION	CYL #	CODE	ROD	BORE	KIT #	Misc-Serial #'s, Parts, etc.	List \$
MODEL D4D							
RIPPER	6J3308	P-UB-10	2-1/2	5-1/2	CTC-8T1374		60.89
	6J3308	P-UB-10	2-1/2	5-1/2	CTC-9X2050		65.65
RIPPER PIN PULLER	4H6711	P-V-10	1-1/4	4	CTC-8T1480		53.94
TILT	5J1603	P-V-10	2	4-3/4	CTC-7X2677		76.32
TRACK ADJUSTER		TRK ADJ			CTC-FIG4400		31.32
MODEL D4E							
DOZER	4T4574	P-UB-10	2	3-1/2	CTC-7X2769		73.60
	4T4575	P-UB-10	2	3-1/2	CTC-7X2769		73.60
DOZER TILT	5J1603	P-V-10	2	4-3/4	CTC-7X2677		76.32
LIFT	3G0892	P-UB-10	1-3/4	3-1/2	CTC-7X2762		65.25
	3G0892	P-UB-10	1-3/4	3-1/2	CTC-7X2784		36.73
	7J8302	P-UB-10	2-1/2	4	CTC-7X2659		102.22
	7J9223	P-UB-10	1-1/2	3-1/2	CTC-7X2752		62.21
RIPPER	8J6894	P-UB-10	1-1/2	3-1/2	CTC-7X2752		62.21
	3G5189	P-UB-10	2-1/2	5	CTC-7X2658		113.62
	6J3308	P-UB-10	2-1/2	5-1/2	CTC-8T1374		60.89
	6J3308	P-UB-10	2-1/2	5-1/2	CTC-9X2050		65.65
RIPPER PIN PULLER	4H6711	P-V-10	1-1/4	4	CTC-8T1480		53.94
STEERING	3G0892	P-UB-10	1-3/4	3-1/2	CTC-7X2762		65.25
	3G0892	P-UB-10	1-3/4	3-1/2	CTC-7X2784		36.73
	4T1574	P-UB-10	2	4	CTC-7X2789		66.51
	6E4892	P-UB-10	1-3/4	3-1/2	CTC-7X2784		36.73
	7J9685	P-UB-10	1-1/2	3-1/2	CTC-7X2812		67.84
TILT	5J1603	P-V-10	2	4-3/4	CTC-7X2677		76.32
TRACK ADJUSTER		TRK ADJ			CTC-FIG4400		31.32
MODEL D4H							
ANGLING	1006174	P-UB-10	1-3/4	3-1/2	CTC-7X2784		36.73
	4T1683	P-UB-10	1-3/4	3-1/2	CTC-7X2784		36.73
	9T9247	P-UB-10	1-3/4	3-1/2	CTC-7X2784		36.73
DOZER LIFT	3G9226	P-UB-10	2	4-1/4	CTC-7X2819		68.55
LIFT	3G9226	P-UB-10	2	4-1/4	CTC-7X2819		68.55
	4T4783	P-UB-10	2-1/4	3-3/4	CTC-7X2798		49.49
	8J6894	P-UB-10	1-1/2	3-1/2	CTC-7X2752		62.21
RIPPER	3G9892	P-UB-10	2	4	CTC-1328816		60.48
TILT	1U2568	P-UB-10	2	4-1/4	CTC-7X2819		68.55
	4T1063	P-UB-10	2	4-1/4	CTC-1378662		88.25
	8J6893	P-UB-10	2	4	CTC-7X2789		66.51
	9T8760	P-UB-10	2	4-1/4	CTC-1378662		88.25
	9T8760	P-UB-10	2	4-1/4	CTC-7X2766		28.77
	9T9557	P-UB-10	2	4-1/4	CTC-1378662		88.25
MODEL D4L							
DOZER LIFT	3G9226	P-UB-10	2	4-1/4	CTC-7X2819		68.55
MODEL D4TSKH							
ANGLING	1006174	P-UB-10	1-3/4	3-1/2	CTC-7X2784		36.73
	9T9247	P-UB-10	1-3/4	3-1/2	CTC-7X2784		36.73
LIFT	6E0365	P-UB-10	2	4-1/4	CTC-7X2819		68.55
	6E0366	P-UB-10	2-1/2	4-3/4	CTC-1328811		105.26
TILT	9T9557	P-UB-10	2	4-1/4	CTC-1378662		88.25

REPLACEMENT KITS FOR CATERPILLAR® EQUIPMENT

Track-Type Tractors							
APPLICATION	CYL #	CODE	ROD	BORE	KIT #	Misc-Serial #'s, Parts, etc.	List \$
MODEL D5							
DOZER	5J8174	P-UB-10	2-1/2	4-1/4	CTC-7X2664		58.30
	5J8176	P-UB-10	2-1/2	4-1/4	CTC-7X2664		58.30
LIFT	7J7974	P-UB-10	1-1/2	4	CTC-7X2738		57.03
	7J8299	P-UB-10	2-1/2	4	CTC-1318748		100.39
	7J8302	P-UB-10	2-1/2	4	CTC-1318748		100.39
RIPPER	2K3663	P-UB-10	2-1/2	7-1/4	CTC-7X2661		117.98
	8J1779	P-UB-10	2-1/2	7-1/4	CTC-1542502		126.15
TILT	2J1402	P-UB-10	3	6-1/2	CTC-1318740		113.00
	2J1402	P-UB-10	3	6-1/2	CTC-7X2694		103.59
TRACK ADJUSTER		TRK ADJ			CTC-FIG4400		31.32
MODEL D5B							
LIFT	7J7974	P-UB-10	1-1/2	4	CTC-7X2738		57.03
	7J8299	P-UB-10	2-1/2	4	CTC-1318748		100.39
	7J8302	P-UB-10	2-1/2	4	CTC-7X2659		102.22
	8J6868	P-UB-10	2-1/2	4	CTC-7X2659		102.22
RIPPER	8J1779	P-UB-10	2-1/2	7-1/4	CTC-1542502		126.15
TILT	2J1402	P-UB-10	3	6-1/2	CTC-1318733		134.40
	2J1402	P-UB-10	3	6-1/2	CTC-7X2694		103.59
	7J9695	P-UB-10	2-1/2	5-1/2	CTC-9X2050		65.65
TRACK ADJUSTER		TRK ADJ			CTC-FIG4400		31.32
MODEL D5C							
ANGLING	1363156	P-UB-10	1-1/2	3-1/2	CTC-1327058		67.73
	1390548	P-UB-10	1-1/2	3	CTC-7X2751		41.76
	9J8698	P-UB-10	1-1/2	3-1/2	CTC-1327058		67.73
LIFT	1412915	P-UB-10	1-1/2	3-1/2	CTC-1327058		67.73
	7J9223	P-UB-10	1-1/2	3-1/2	CTC-1327058		67.73
RIPPER	7J9920	P-UB-10	2	4	CTC-1328816		60.48
TILT	1437219	P-UB-10	1-1/2	3-1/2	CTC-1327058		67.73
	9J8674	P-UB-10	1-1/2	3-1/2	CTC-1327058		67.73
MODEL D5E							
LIFT	8J6868	P-UB-10	2-1/2	4	CTC-7X2659		102.22
RIPPER	8J1779	P-UB-10	2-1/2	7-1/4	CTC-1542502		126.15
TRACK ADJUSTER		TRK ADJ			CTC-FIG4400		31.32
MODEL D5H							
ANGLING	4T1666	P-UB-10	2	4	CTC-7X2789		66.51
	9T9273	P-UB-10	2	4	CTC-1113302		77.57
LIFT	1153524	P-UB-10	2-1/4	3-3/4	CTC-1361897		103.79
	1U1839	P-UB-10	2-1/4	3-3/4	CTC-1361897		103.79
	1U2568	P-UB-10	2	4-1/4	CTC-7X2819		68.55
	3G5909	P-UB-10	2	4	CTC-7X2789		66.51
	4T1089	P-UB-10	2-1/4	3-3/4	CTC-1361897		103.79
	4T1659	P-UB-10	2-1/4	4-1/2	CTC-1326770		97.93
	6E5400	P-UB-10	2-1/4	4-1/2	CTC-1354392		101.01
	RIPPER	3G5909	P-UB-10	2	4	CTC-1328816	
TILT	9T2716	P-UB-10	2-1/2	5	CTC-7X2658		113.62
	1U3991	P-UB-10	3	6-1/2	CTC-1126550		115.57
	1U3991	P-UB-10	3	6-1/2	CTC-8T1408		52.65
	4T1625	P-UB-10	2-1/4	4-3/4	CTC-1318778		102.92

REPLACEMENT KITS FOR CATERPILLAR® EQUIPMENT

CATERPILLAR®

Track-Type Tractors							
APPLICATION	CYL #	CODE	ROD	BORE	KIT #	Misc-Serial #'s, Parts, etc.	List \$
MODEL D5H							
TILT	4T2613	P-UB-10	2-1/2	5	CTC-1315118		116.00
	4T2613	P-UB-10	2-1/2	5	CTC-7X2658		113.62
MODEL D5M							
ANGLING	1061286	P-UB-10	1-3/4	3-1/2	CTC-7X2784		36.73
	1378456	P-UB-10	1-3/4	3-1/2	CTC-7X2784		36.73
	1526482	P-UB-10	1-3/4	3-1/2	CTC-7X2784		36.73
LIFT	1059822	P-UB-10	2	4-1/4	CTC-1378662		88.25
	1607610	P-UB-10	2-1/2	4-3/4	CTC-1328811		105.26
	6E0366	P-UB-10	2-1/2	4-3/4	CTC-1328811		105.26
RIPPER	3G9892	P-UB-10	2	4	CTC-1328816		60.48
MODEL D5TSKH							
ANGLING	9T9273	P-UB-10	2	4	CTC-1113302		77.57
LIFT	6E0366	P-UB-10	2-1/2	4-3/4	CTC-1328811		105.26
MODEL D6							
RIPPER	2K3663	P-UB-10	2-1/2	7-1/4	CTC-7X2661		117.98
RIPPER LIFT	8J1779	P-UB-10	2-1/2	7-1/4	CTC-7X2661		117.98
MODEL D6 LGP							
LIFT	8J6868	P-UB-10	2-1/2	4	CTC-7X2659		102.22
MODEL D6B							
LIFT	5J8173	P-UB-10	2-1/2	4-1/4	CTC-7X2664		58.30
RIPPER	2K3663	P-UB-10	2-1/2	7-1/4	CTC-7X2661		117.98
RIPPER LIFT	8J1779	P-UB-10	2-1/2	7-1/4	CTC-7X2661		117.98
TILT	2J1402	P-UB-10	3	6-1/2	CTC-1318733		134.40
	2J1402	P-UB-10	3	6-1/2	CTC-7X2694		103.59
TRACK ADJUSTER		TRK ADJ			CTC-FIG4400		31.32
MODEL D6C							
BACKHOE STICK / BLADE SHIFT	8J5448	P-UB-10	2	4	CTC-1328816		60.48
DOZER	5J8172	P-UB-10	2-1/2	4-1/4	CTC-7X2664		58.30
	5J8173	P-UB-10	2-1/2	4-1/4	CTC-7X2664		58.30
DOZER LIFT	4J4891	P-U-10	2	3-1/2	CTC-7X2806		79.11
DOZER TILT	1U3495	P-UB-10	2-1/2	6	CTC-7X2674		84.27
	2J1402	P-UB-10	3	6-1/2	CTC-7X2694		103.59
LIFT	5J1603	P-V-10	2	4-3/4	CTC-7X2677		76.32
	7J3171	P-UB-10	2-1/2	6	CTC-7X2674		84.27
	7J3172	P-UB-10	2-1/2	6	CTC-7X2674		84.27
	7J7974	P-UB-10	1-1/2	4	CTC-7X2738		57.03
	7J8302	P-UB-10	2-1/2	4	CTC-1318748		100.39
RIPPER	8J6868	P-UB-10	2-1/2	4	CTC-1318748		100.39
	2K3663	P-UB-10	2-1/2	7-1/4	CTC-7X2661		117.98
	6J3308	P-UB-10	2-1/2	5-1/2	CTC-8T1374		60.89
TILT	8J1779	P-UB-10	2-1/2	7-1/4	CTC-1542502		126.15
	2J1402	P-UB-10	3	6-1/2	CTC-1318733		134.40
TRACK ADJUSTER		TRK ADJ			CTC-FIG3400		39.00
MODEL D6D							
BACKHOE STICK / BLADE SHIFT	8J5448	P-UB-10	2	4	CTC-1328816		60.48
DOZER TILT	1U3495	P-UB-10	2-1/2	6	CTC-7X2674		84.27
	2J1402	P-UB-10	3	6-1/2	CTC-7X2694		103.59

REPLACEMENT KITS FOR CATERPILLAR® EQUIPMENT

Track-Type Tractors							
APPLICATION	CYL #	CODE	ROD	BORE	KIT #	Misc-Serial #'s, Parts, etc.	List \$
MODEL D6D							
DOZER TILT	7J3171	P-UB-10	2-1/2	6	CTC-7X2674		84.27
	7J3172	P-UB-10	2-1/2	6	CTC-7X2674		84.27
DOZER TILT RH LIFT	7J9695	P-UB-10	2-1/2	5-1/2	CTC-8T1374		60.89
	7J7974	P-UB-10	1-1/2	4	CTC-7X2738		57.03
RIPPER TILT	7J8302	P-UB-10	2-1/2	4	CTC-1318748		100.39
	8J6868	P-UB-10	2-1/2	4	CTC-1318748		100.39
	8J1779	P-UB-10	2-1/2	7-1/4	CTC-1542502		126.15
TILT LH	1U3495	P-UB-10	2-1/2	6	CTC-7X2692		107.12
	2J1402	P-UB-10	3	6-1/2	CTC-1318733		134.40
	7J3171	P-UB-10	2-1/2	6	CTC-7X2692		107.12
TILT RH	7J9695	P-UB-10	2-1/2	5-1/2	CTC-9X2050		65.65
	9T2797	P-UB-10	2-1/2	6	CTC-7X2674		84.27
TRACK ADJUSTER	6J0518	P-UB-10	2-1/2	6	CTC-7X2692		107.12
	7J3172	P-UB-10	2-1/2	6	CTC-7X2692		107.12
	6J0517	P-UB-10	2-1/2	6	CTC-7X2692		107.12
		TRK ADJ			CTC-FIG3400		39.00
MODEL D6E, D6G							
LIFT	8J6868	P-UB-10	2-1/2	4	CTC-1318748		100.39
N/A	2J1402	P-UB-10	3	6-1/2	CTC-1318733		134.40
RIPPER	1306135	P-UB-10	2-1/2	7-1/4	CTC-1542502		126.15
	8J1779	P-UB-10	2-1/2	7-1/4	CTC-1542502		126.15
TILT	1U3495	P-UB-10	2-1/2	6	CTC-7X2674		84.27
	1U3495	P-UB-10	2-1/2	6	CTC-7X2692		107.12
	9T2797	P-UB-10	2-1/2	6	CTC-7X2674		84.27
MODEL D6H							
DOZER	1U3989	P-UB-10	2-1/2	3-3/4	CTC-1318700		98.42
	1U3990	P-UB-10	2-1/2	3-3/4	CTC-1318700		98.42
	4Y3807	P-UB-10	2-1/2	3-3/4	CTC-1318700		98.42
	9T8952	P-UB-10	2-1/2	4	CTC-1353223		104.61
	9T8996	P-UB-10	2-1/2	4	CTC-1353223		104.61
DOZER TILT	9T6095	P-UB-10	2-1/2	6	CTC-7X2655		74.09
RIPPER	9T2716	P-UB-10	2-1/2	5	CTC-7X2658		113.62
TILT	1U3991	P-UB-10	3	6-1/2	CTC-1126550		115.57
	1U3991	P-UB-10	3	6-1/2	CTC-7X2694		103.59
	1U3992	P-UB-10	2-1/2	6	CTC-7X2655		74.09
	1U3992	P-UB-14	2-1/2	6	CTC-7X2836		167.54
	3G2798	P-UB-10	2-1/2	5-1/2	CTC-7X2671		96.59
	9T6095	P-UB-10	2-1/2	6	CTC-1315164		132.65
	9T8760	P-UB-10	2	4-1/4	CTC-7X2766		28.77
MODEL D6M							
ANGLING	1103786	P-UB-10	2	4	CTC-1113302		77.57
	1526485	P-UB-10	2	4	CTC-1113302		77.57
LIFT	1103269	P-UB-10	2-1/4	4-1/2	CTC-1326770		97.93
	1153524	P-UB-10	2-1/4	3-3/4	CTC-1361897		103.79
N/A	1375107	P-UB-10	2	4	CTC-1113302		77.57
RIPPER	3G5909	P-UB-10	2	4	CTC-1328816		60.48
	9T2716	P-UB-10	2-1/2	5	CTC-7X2658		113.62
TILT	1600054	P-UB-10	2-1/2	5-1/2	CTC-7X2653		105.93

REPLACEMENT KITS FOR CATERPILLAR® EQUIPMENT

Track-Type Tractors							
APPLICATION	CYL #	CODE	ROD	BORE	KIT #	Misc-Serial #'s, Parts, etc.	List \$
MODEL D6R							
DOZER	1278931	P-UB-10	2-1/2	4	CTC-1353223		104.61
	1294258	P-UB-10	2-1/2	4	CTC-1353223		104.61
RIPPER	9T2716	P-UB-10	2-1/2	5	CTC-7X2658		113.62
TILT	1U3991	P-UB-10	3	6-1/2	CTC-1126550		115.57
	1U3991	P-UB-10	3	6-1/2	CTC-8T1408		52.65
	9T6095	P-UB-10	2-1/2	6	CTC-1315164		132.65
	9T6095	P-UB-10	2-1/2	6	CTC-7X2655		74.09
MODEL D7							
TRACK ADJUSTER		TRK ADJ			CTC-FIG3400		39.00
MODEL D7 LGP							
LIFT LH	9J4887	P-UB-10	2-1/2	4-3/4	CTC-1014201		87.36
LIFT RH	9J4888	P-UB-10	2-1/2	4-3/4	CTC-1014201		87.36
MODEL D7A, D7B, D7C, D7D, D7E							
DOZER LIFT	3R6781	P-UB-10	2-1/2	4-3/4	CTC-7X2660		117.13
DOZER LIFT LH	1U2133	P-UB-10	2-1/2	4-3/4	CTC-7X2660		117.13
	1U2136	P-UB-10	2-1/2	4-3/4	CTC-7X2660		117.13
	1U2134	P-UB-10	2-1/2	4-3/4	CTC-7X2660		117.13
DOZER LIFT RH	1U2134	P-UB-10	2-1/2	4-3/4	CTC-7X2660		117.13
	1U2135	P-UB-10	2-1/2	4-3/4	CTC-7X2660		117.13
DOZER TILT	2J6783	P-U-10	3-1/2	8-1/4	CTC-7X2720		117.81
	3J9694	P-U-10	3-1/2	8-1/4	CTC-7X2720		117.81
	3R6770	P-U-10	3-1/2	8-1/4	CTC-7X2720		117.81
	9J8748	P-UB-10	3	6-1/2	CTC-7X2694		103.59
LIFT	3J3271	P-UB-10	2-1/2	6	CTC-7X2679		90.10
	4J6177	P-UB-10	2-1/2	4-3/4	CTC-1014201		87.36
	4J6177	P-UB-10	2-1/2	4-3/4	CTC-7X2660		117.13
RIPPER	3J6439	P-UB-10	2-1/2	6	CTC-7X2679		90.10
RIPPER LIFT	3R6724	P-UB-10	2-1/2	6	CTC-7X2679	D7E only	90.10
	4T9290	P-UB-10	2-1/2	6	CTC-7X2655		74.09
TILT	5J7929	P-UB-10	2-1/2	6	CTC-7X2692		107.12
	6J9752	P-UB-10	3	6-1/2	CTC-1126550		115.57
TRACK ADJUSTER		TRK ADJ			CTC-FIG3400	D7C, D7D only	39.00
		TRK ADJ			CTC-FIG3404	D7E only	81.99
MODEL D7F							
DOZER LH	1041944	P-UB-10	2-1/2	4-3/4	CTC-1700221		107.16
	1U2136	P-UB-10	2-1/2	4-3/4	CTC-7X2773		116.33
DOZER LIFT	3R6781	P-UB-10	2-1/2	4-3/4	CTC-7X2660		117.13
DOZER LIFT LH	1U2133	P-UB-10	2-1/2	4-3/4	CTC-7X2660		117.13
	1U2136	P-UB-10	2-1/2	4-3/4	CTC-7X2660		117.13
DOZER LIFT RH	1U2134	P-UB-10	2-1/2	4-3/4	CTC-7X2660		117.13
	1U2135	P-UB-10	2-1/2	4-3/4	CTC-7X2660		117.13
DOZER RH	1041943	P-UB-10	2-1/2	4-3/4	CTC-1700221		107.16
DOZER TILT	1U2135	P-UB-10	2-1/2	4-3/4	CTC-7X2773		116.33
	2J6783	P-U-10	3-1/2	8-1/4	CTC-7X2720		117.81
LIFT	3J9694	P-U-10	3-1/2	8-1/4	CTC-7X2720		117.81
	3R6770	P-U-10	3-1/2	8-1/4	CTC-7X2720		117.81
	9J8748	P-UB-10	3	6-1/2	CTC-7X2694		103.59
	3J3271	P-UB-10	2-1/2	6	CTC-7X2679		90.10
	4J6177	P-UB-10	2-1/2	4-3/4	CTC-7X2660		117.13

REPLACEMENT KITS FOR CATERPILLAR® EQUIPMENT

Track-Type Tractors							
APPLICATION	CYL #	CODE	ROD	BORE	KIT #	Misc-Serial #'s, Parts, etc.	List \$
MODEL D7F							
LIFT LH	7J3334	P-UB-10	2-1/2	4-3/4	CTC-7X2773		116.33
LIFT RH	7J3333	P-UB-10	2-1/2	4-3/4	CTC-7X2773		116.33
RIPPER	3J6439	P-UB-10	2-1/2	6	CTC-7X2679		90.10
RIPPER LIFT	3R6724	P-UB-10	2-1/2	6	CTC-7X2679		90.10
	4T9290	P-UB-10	2-1/2	6	CTC-7X2655		74.09
TILT	5J7929	P-UB-10	2-1/2	6	CTC-7X2692		107.12
	6J9752	P-UB-10	3	6-1/2	CTC-1126550		115.57
	9J8748	P-UB-10	3	6-1/2	CTC-1126550		115.57
TRACK ADJUSTER		TRK ADJ			CTC-FIG3401		36.41
MODEL D7G							
DOZER LH	1041944	P-UB-10	2-1/2	4-3/4	CTC-1700221		107.16
	1U2133	P-UB-10	2-1/2	4-3/4	CTC-7X2773		116.33
	1U2136	P-UB-10	2-1/2	4-3/4	CTC-7X2773		116.33
DOZER LIFT	3R6781	P-UB-10	2-1/2	4-3/4	CTC-7X2660		117.13
DOZER LIFT LH	1U2133	P-UB-10	2-1/2	4-3/4	CTC-7X2660		117.13
	1U2136	P-UB-10	2-1/2	4-3/4	CTC-7X2660		117.13
DOZER LIFT RH	1U2134	P-UB-10	2-1/2	4-3/4	CTC-7X2660		117.13
	1U2135	P-UB-10	2-1/2	4-3/4	CTC-7X2660		117.13
DOZER RH	1041943	P-UB-10	2-1/2	4-3/4	CTC-1700221		107.16
	1U2134	P-UB-10	2-1/2	4-3/4	CTC-7X2773		116.33
	1U2135	P-UB-10	2-1/2	4-3/4	CTC-7X2773		116.33
DOZER TILT	2J6783	P-U-10	3-1/2	8-1/4	CTC-7X2720		117.81
	3J9694	P-U-10	3-1/2	8-1/4	CTC-7X2720		117.81
	3R6770	P-U-10	3-1/2	8-1/4	CTC-7X2720		117.81
	9J8748	P-UB-10	3	6-1/2	CTC-7X2694		103.59
LIFT	3J3271	P-UB-10	2-1/2	6	CTC-7X2679		90.10
	3R6781	P-UB-10	2-1/2	4-3/4	CTC-7X2660		117.13
	4J6177	P-UB-10	2-1/2	4-3/4	CTC-1014201		87.36
	4J6177	P-UB-10	2-1/2	4-3/4	CTC-7X2660		117.13
LIFT LH	7J3334	P-UB-10	2-1/2	4-3/4	CTC-7X2773		116.33
LIFT RH	7J3333	P-UB-10	2-1/2	4-3/4	CTC-7X2773		116.33
	9J4888	P-UB-10	2-1/2	4-3/4	CTC-7X2773		116.33
RIPPER	3J6439	P-UB-10	2-1/2	6	CTC-7X2679		90.10
RIPPER LIFT	4T9290	P-UB-10	2-1/2	6	CTC-7X2655		74.09
TILT	2J1402	P-UB-10	3	6-1/2	CTC-1318733		134.40
	5J7929	P-UB-10	2-1/2	6	CTC-7X2692		107.12
	6J9752	P-UB-10	3	6-1/2	CTC-1126550		115.57
	9J8748	P-UB-10	3	6-1/2	CTC-1126550		115.57
	9J8748	P-UB-10	3	6-1/2	CTC-8T1408		52.65
TILT LH	5J7930	P-UB-10	2-1/2	6	CTC-7X2692		107.12
	7J9364	P-UB-14	2-1/2	6	CTC-7X2669		152.43
TRACK ADJUSTER		TRK ADJ			CTC-FIG3401		36.41
MODEL D7H							
DOZER	1291908	P-UB-10	2-1/2	4	CTC-1353223		104.61
	1U4851	P-UB-10	2-1/2	4	CTC-1353253		104.90
	1U4852	P-UB-10	2-1/2	4	CTC-1353253		104.90
DOZER LIFT	1U3989	P-UB-10	2-1/2	3-3/4	CTC-7X2670		59.75
	1U4851	P-UB-10	2-1/2	4	CTC-1318748		100.39

REPLACEMENT KITS FOR CATERPILLAR® EQUIPMENT

Track-Type Tractors							
APPLICATION	CYL #	CODE	ROD	BORE	KIT #	Misc-Serial #'s, Parts, etc.	List \$
MODEL D7H							
DOZER LIFT	1U4852	P-UB-10	2-1/2	4	CTC-1318748		100.39
DOZER TILT	3G4533	P-UB-10	3	6-1/2	CTC-7X2694		103.59
	9T1370	P-UB-10	3	6-1/2	CTC-7X2694		103.59
LIFT	1294259	P-UB-10	2-1/2	4	CTC-1353223		104.61
	1U4852	P-UB-10	2-1/2	4	CTC-7X2659		102.22
	4T2098	P-UB-10	2-1/2	4-3/4	CTC-7X2673		116.33
	6E1836	P-UB-10	2-1/2	4	CTC-1353223		104.61
	6E1841	P-UB-10	2-1/2	4	CTC-1353223		104.61
RIPPER	4T8639	P-UB-10	2-3/4	5-1/4	CTC-1326121		124.15
	9T0142	P-UB-10	3	7-1/4	CTC-1326184		147.29
TILT	1124814	P-UB-10	2-3/4	6	CTC-1352167		120.36
	3G4533	P-UB-10	3	6-1/2	CTC-1126550		115.57
	6J9752	P-UB-10	3	6-1/2	CTC-1126550		115.57
	9T6113	P-UB-10	3	6-1/2	CTC-1126550		115.57
MODEL D7R							
DOZER	1291908	P-UB-10	2-1/2	4	CTC-1353223		104.61
	1U4851	P-UB-10	2-1/2	4	CTC-1318748		100.39
	1U4851	P-UB-10	2-1/2	4	CTC-1353253		104.90
	1U4852	P-UB-10	2-1/2	4	CTC-1318748		100.39
	1U4852	P-UB-10	2-1/2	4	CTC-1353253		104.90
LIFT	1294259	P-UB-10	2-1/2	4	CTC-1353223		104.61
	6E1836	P-UB-10	2-1/2	4	CTC-1353223		104.61
	6E1841	P-UB-10	2-1/2	4	CTC-1353223		104.61
RIPPER	9T0142	P-UB-10	3	7-1/4	CTC-1326184		147.29
TILT	1124814	P-UB-10	2-3/4	6	CTC-1352167		120.36
	3G4533	P-UB-10	3	6-1/2	CTC-1126550		115.57
	9T6113	P-UB-10	3	6-1/2	CTC-1126550		115.57
TILT LH	1470709	P-UB-10	3	6-1/2	CTC-1126550		115.57
TILT RH	1470708	P-UB-10	3	6-1/2	CTC-1126550		115.57
MODEL D8							
DOZER LIFT LH	3G8089	P-UB-10	2-3/4	5	CTC-7X2682		101.82
	8J8585	P-UB-10	2-3/4	5	CTC-7X2824		77.53
DOZER LIFT RH	3G8090	P-UB-10	2-3/4	5	CTC-7X2682		101.82
	8J8584	P-UB-10	2-3/4	5	CTC-7X2824		77.53
DOZER TILT	2J3894	P-U-10	3-1/2	8-1/4	CTC-7X2720		117.81
LIFT	2J2470	P-UB-10	2-1/2	6	CTC-7X2679		90.10
	3J2189	P-UB-10	2-1/2	6	CTC-7X2679		90.10
	5J1243	P-UB-10	2-1/2	6	CTC-7X2679		90.10
	5J2815	P-UB-10	2-1/2	6	CTC-7X2679		90.10
LIFT LH	5J9378	P-UB-10	2-1/2	5	CTC-7X2675		81.02
	8J8585	P-UB-10	2-3/4	5	CTC-7X2824		77.53
LIFT RH	5J9708	P-UB-10	2-1/2	5	CTC-7X2675		81.02
PIN PULLER	4J5057	P-V-10	1-1/4	4	CTC-8T1480		53.94
RIPPER	6J9129	P-UB-10	3	7-1/4	CTC-7X2702		185.12
RIPPER LIFT LH	7J3222	P-UB-10	3-1/4	8-1/4	CTC-7X2715		172.78
	7J3222	P-UB-10	3-1/4	8-1/4	CTC-7X2801		159.34
RIPPER LIFT RH	7J3221	P-UB-10	3-1/4	8-1/4	CTC-7X2715		172.78
	7J3221	P-UB-10	3-1/4	8-1/4	CTC-7X2801		159.34

REPLACEMENT KITS FOR CATERPILLAR® EQUIPMENT

Track-Type Tractors							
APPLICATION	CYL #	CODE	ROD	BORE	KIT #	Misc-Serial #'s, Parts, etc.	List \$
MODEL D8							
RIPPER PIN PULLER	7J0508	P-V-10	1-1/4	4	CTC-8T1480		53.94
	8J2071	P-UB-10	1-1/2	4	CTC-7X2738		57.03
TILT	6J2472	P-UB-10	3-1/2	8-1/4	CTC-7X2728		114.08
	7J0192	P-UB-10	3-1/2	8-1/4	CTC-7X2721		189.85
	8J8682	P-UB-10	3-1/2	8-1/4	CTC-7X2721		189.85
TRACK ADJUSTER		TRK ADJ			CTC-FIG2400		50.09
MODEL D8H							
ANGLING	3J2189	P-UB-10	2-1/2	6	CTC-7X2679		90.10
DOZER	2J3894	P-U-10	3-1/2	8-1/4	CTC-7X2720		117.81
	5J2815	P-UB-10	2-1/2	6	CTC-7X2679		90.10
LIFT	2J2470	P-UB-10	2-1/2	6	CTC-7X2679		90.10
	3J2189	P-UB-10	2-1/2	6	CTC-7X2679		90.10
	5J1243	P-UB-10	2-1/2	6	CTC-7X2679		90.10
LIFT LH	5J9378	P-UB-10	2-1/2	5	CTC-7X2675		81.02
LIFT RH	5J9708	P-UB-10	2-1/2	5	CTC-7X2675		81.02
PIN PULLER	4J5057	P-V-10	1-1/4	4	CTC-8T1480		53.94
	7J0508	P-V-10	1-1/4	4	CTC-8T1480		53.94
	8J2071	P-UB-10	1-1/2	4	CTC-7X2738		57.03
	6J9129	P-UB-10	3	7-1/4	CTC-7X2702		185.12
RIPPER	7J3222	P-UB-10	3-1/4	8-1/4	CTC-7X2715		172.78
	7J3222	P-UB-10	3-1/4	8-1/4	CTC-7X2801		159.34
RIPPER LIFT LH	7J3222	P-UB-10	3-1/4	8-1/4	CTC-7X2715		172.78
RIPPER LIFT RH	7J3221	P-UB-10	3-1/4	8-1/4	CTC-7X2715		172.78
RIPPER PIN PULLER	7J0508	P-V-10	1-1/4	4	CTC-8T1480		53.94
RIPPER RH	7J3221	P-UB-10	3-1/4	8-1/4	CTC-7X2801		159.34
TILT	6J2472	P-UB-10	3-1/2	8-1/4	CTC-7X2728		114.08
	7J0192	P-UB-10	3-1/2	8-1/4	CTC-1371974		166.40
	7J0192	P-UB-10	3-1/2	8-1/4	CTC-7X2721		189.85
TRACK ADJUSTER		TRK ADJ			CTC-FIG1401		53.75
MODEL D8K							
DOZER LIFT LH	3G8089	P-UB-10	2-3/4	5	CTC-7X2682		101.82
	8J8585	P-UB-10	2-3/4	5	CTC-7X2824		77.53
DOZER LIFT RH	3G8090	P-UB-10	2-3/4	5	CTC-7X2682		101.82
	8J8584	P-UB-10	2-3/4	5	CTC-7X2824		77.53
PIN PULLER	7J0508	P-V-10	1-1/4	4	CTC-8T1480		53.94
	8J2071	P-UB-10	1-1/2	4	CTC-7X2738		57.03
RIPPER	6J9129	P-UB-10	3	7-1/4	CTC-7X2702		185.12
	7J3222	P-UB-10	3-1/4	8-1/4	CTC-7X2715		172.78
RIPPER LIFT LH	7J3222	P-UB-10	3-1/4	8-1/4	CTC-7X2715		172.78
	7J3222	P-UB-10	3-1/4	8-1/4	CTC-7X2801		159.34
RIPPER LIFT RH	7J3221	P-UB-10	3-1/4	8-1/4	CTC-7X2715		172.78
	7J3221	P-UB-10	3-1/4	8-1/4	CTC-7X2801		159.34
RIPPER PIN PULLER.	8J2071	P-UB-10	1-1/2	4	CTC-7X2738		57.03
TILT	7J0192	P-UB-10	3-1/2	8-1/4	CTC-7X2721		189.85
	8J8682	P-UB-10	3-1/2	8-1/4	CTC-1371974		166.40
MODEL D8L							
DOZER	9J8802	P-UB-10	3-1/2	7-1/2	CTC-7X2722		121.12
DOZER LIFT	9J8802	P-UB-10	3-1/2	7-1/2	CTC-7X2722		121.12

REPLACEMENT KITS FOR CATERPILLAR® EQUIPMENT

CATERPILLAR®

Track-Type Tractors							
APPLICATION	CYL #	CODE	ROD	BORE	KIT #	Misc-Serial #'s, Parts, etc.	List \$
MODEL D8L							
DOZER LIFT	9T2860	P-UB-10	3	5-1/4	CTC-7X2756		82.44
DOZER TILT	3G5707	P-UB-10	3-1/2	8-1/4	CTC-7X2721		189.85
LIFT	3G8537	P-UB-10	3	5-1/4	CTC-7X2756		82.44
	9T2860	P-UB-10	3	5-1/4	CTC-7X2756		82.44
PIN PULLER	1U3373	P-UB-10	1-1/2	4	CTC-7X2738		57.03
RIPPER	3G6457	P-UB-10	3-1/4	8-1/4	CTC-7X2715		172.78
RIPPER LIFT	3G6457	P-UB-10	3-1/4	8-1/4	CTC-7X2715		172.78
RIPPER PIN PULLER.	1U3373	P-UB-10	1-1/2	4	CTC-7X2738		57.03
TILT	3G5707	P-UB-10	3-1/2	8-1/4	CTC-1371974		166.40
MODEL D8N							
DOZER	6E1102	P-UB-10	3	4-1/2	CTC-1353802		112.08
	6E1175	P-UB-10	3-1/2	7-1/4	CTC-1309483		189.24
	9T0140	P-UB-10	2-3/4	4-1/4	CTC-7X2451		72.31
	9T0141	P-UB-10	3-1/2	7-1/2	CTC-7X2722		121.12
PIN PULLER	6E3113	P-UB-10	1-3/4	4	CTC-1316108		70.83
	9T2066	P-UB-10	1-1/2	4	CTC-7X2738		57.03
RIPPER	9T0142	P-UB-10	3	7-1/4	CTC-1326184		147.29
	9T0143	P-UB-10	3	6-1/2	CTC-1279809		150.95
TILT	6E0397	P-UB-10	3	7-1/4	CTC-1326127		135.62
	9T6077	P-UB-10	3	6-1/2	CTC-1126550		115.57
MODEL D8R							
DOZER	6E1102	P-UB-10	3	4-1/2	CTC-1353802		112.08
	6E1175	P-UB-10	3-1/2	7-1/4	CTC-1309483		189.24
PIN PULLER	6E3113	P-UB-10	1-3/4	4	CTC-1316108		70.83
	9T2066	P-UB-10	1-1/2	4	CTC-7X2738		57.03
RIPPER	4Z6313	P-UB-10	3	6-1/2	CTC-1279809		150.95
	9T0142	P-UB-10	3	7-1/4	CTC-1326184		147.29
	9T0143	P-UB-10	3	6-1/2	CTC-1279809		150.95
TILT	6E0397	P-UB-10	3	7-1/4	CTC-1326127		135.62
MODEL D9D							
TRACK ADJUSTER		TRK ADJ			CTC-FIG0401		61.14
MODEL D9G							
DOZER TILT	2J6705	P-U-10	3-1/2	8-1/4	CTC-7X2720		117.81
LIFT LH	7J1488	P-UB-10	3-1/4	9-1/4	CTC-7X2707		225.72
LIFT RH	7J1487	P-UB-10	3-1/4	9-1/4	CTC-7X2707		225.72
PIN PULLER	4J5057	P-V-10	1-1/4	4	CTC-8T1480		53.94
	7J0508	P-V-10	1-1/4	4	CTC-8T1480		53.94
	8J2071	P-UB-10	1-1/2	4	CTC-7X2738		57.03
RIPPER	6J7810	P-UB-10	3-1/2	8-1/4	CTC-7X2725		253.73
RIPPER LIFT LH	7J1488	P-UB-10	3-1/4	9-1/4	CTC-7X2707		225.72
RIPPER LIFT RH	7J1487	P-UB-10	3-1/4	9-1/4	CTC-7X2707		225.72
RIPPER PIN PULLER.	8J2071	P-UB-10	1-1/2	4	CTC-7X2738		57.03
RIPPER TILT	6J7810	P-UB-10	3-1/2	8-1/4	CTC-7X2725		253.73
TILT	6J1570	P-UB-10	3-1/2	8-1/4	CTC-1371974		166.40
	6J1570	P-UB-10	3-1/2	8-1/4	CTC-7X2721		189.85
TRACK ADJUSTER		TRK ADJ			CTC-FIG0401		61.14
		TRK ADJ			CTC-FIG0402		72.03

REPLACEMENT KITS FOR CATERPILLAR® EQUIPMENT

Track-Type Tractors							
APPLICATION	CYL #	CODE	ROD	BORE	KIT #	Misc-Serial #'s, Parts, etc.	List \$
MODEL D9H							
DOZER LH	3G1174	P-UB-10	3	6-1/4	CTC-7X2697		103.14
	3G1177	P-UB-10	3	6-1/4	CTC-7X2697		103.14
DOZER RH	3G1175	P-UB-10	3	6-1/4	CTC-7X2697		103.14
	3G1176	P-UB-10	3	6-1/4	CTC-7X2697		103.14
LIFT LH	3G1174	P-UB-10	3	6-1/4	CTC-7X2697		103.14
	3G1177	P-UB-10	3	6-1/4	CTC-7X2697		103.14
	7J1488	P-UB-10	3-1/4	9-1/4	CTC-1895377		157.22
LIFT RH	7J1488	P-UB-10	3-1/4	9-1/4	CTC-7X2707		225.72
	3G1175	P-UB-10	3	6-1/4	CTC-7X2697		103.14
	3G1176	P-UB-10	3	6-1/4	CTC-7X2697		103.14
	7J1487	P-UB-10	3-1/4	9-1/4	CTC-1895377		157.22
	7J1487	P-UB-10	3-1/4	9-1/4	CTC-7X2707		225.72
PIN PULLER	8J2071	P-UB-10	1-1/2	4	CTC-7X2738		57.03
RIPPER	6J7810	P-UB-10	3-1/2	8-1/4	CTC-7X2725		253.73
RIPPER LIFT LH	7J1488	P-UB-10	3-1/4	9-1/4	CTC-7X2707		225.72
RIPPER LIFT RH	7J1487	P-UB-10	3-1/4	9-1/4	CTC-7X2707		225.72
RIPPER PIN PULLER.	8J2071	P-UB-10	1-1/2	4	CTC-7X2738		57.03
RIPPER TILT	6J7810	P-UB-10	3-1/2	8-1/4	CTC-7X2725		253.73
TILT	6J1570	P-UB-10	3-1/2	8-1/4	CTC-1371974		166.40
	6J1570	P-UB-10	3-1/2	8-1/4	CTC-7X2721		189.85
MODEL D9L							
DOZER TILT	3G8661	P-UB-10	4	9-1/4	CTC-7X2799		233.31
	4T4248	P-UB-10	4	9-1/4	CTC-7X2799		233.31
LIFT	9J5868	P-UB-10	3-1/4	6	CTC-7X2757		174.50
PIN PULLER	1U3373	P-UB-10	1-1/2	4	CTC-7X2738		57.03
RIPPER LIFT	4T0979	P-UB-10	3-1/4	9-1/4	CTC-7X2707		225.72
RIPPER LIFT LH	4T5111	P-UB-10	3-1/4	9-1/4	CTC-7X2707		225.72
RIPPER LIFT RH	4T5112	P-UB-10	3-1/4	9-1/4	CTC-7X2707		225.72
RIPPER PIN PULLER.	1U3373	P-UB-10	1-1/2	4	CTC-7X2738		57.03
RIPPER TILT	4T6970	P-UB-10	3-1/4	8-1/4	CTC-7X2715		172.78
	4T9977	P-UB-10	3-1/4	8-1/4	CTC-7X2715		172.78
MODEL D9N							
DOZER LIFT	9T2860	P-UB-10	3	5-1/4	CTC-7X2756		82.44
DOZER TILT	3G5707	P-UB-10	3-1/2	8-1/4	CTC-7X2721		189.85
LIFT	9T2860	P-UB-10	3	5-1/4	CTC-7X2756		82.44
PIN PULLER	6E3113	P-UB-10	1-3/4	4	CTC-1316108		70.83
	9T2066	P-UB-10	1-1/2	4	CTC-7X2738		57.03
RIPPER	3G6457	P-UB-10	3-1/4	8-1/4	CTC-7X2715		172.78
RIPPER LIFT	3G6457	P-UB-10	3-1/4	8-1/4	CTC-7X2715		172.78
RIPPER PIN PULLER.	9T2066	P-UB-10	1-1/2	4	CTC-7X2738		57.03
TILT	3G5707	P-UB-10	3-1/2	8-1/4	CTC-1371974		166.40
MODEL D9R							
PIN PULLER	6E3113	P-UB-10	1-3/4	4	CTC-1316108		70.83
TILT LH	6E4835	P-UB-10	3-1/2	8-1/4	CTC-7X2721		189.85
TILT RH	6E4836	P-UB-10	3-1/2	8-1/4	CTC-7X2721		189.85
MODEL D10							
DOZER	1U2711	P-UB-10	4	10-1/2	CTC-1324932		233.31
	3G5761	P-UB-10	4	10-1/2	CTC-1324932		233.31

REPLACEMENT KITS FOR CATERPILLAR® EQUIPMENT

CATERPILLAR®

Track-Type Tractors							
APPLICATION	CYL #	CODE	ROD	BORE	KIT #	Misc-Serial #'s, Parts, etc.	List \$
MODEL D10							
DOZER LH	4T3211	P-UB-10	4	10-1/2	CTC-1324932		233.31
DOZER LIFT LH	4T2727	P-UB-10	4	7	CTC-8T1457		125.26
	9J2959	P-UB-10	4	7	CTC-1326783		169.39
DOZER LIFT RH	4T2728	P-UB-10	4	7	CTC-8T1457		125.26
	9J2958	P-UB-10	4	7	CTC-1326783		169.39
DOZER RH	4T3210	P-UB-10	4	10-1/2	CTC-1324932		233.31
PIN PULLER	1U3373	P-UB-10	1-1/2	4	CTC-7X2738		57.03
	8J2071	P-UB-10	1-1/2	4	CTC-7X2738		57.03
RIPPER	3G2220	P-UB-10	3-1/4	8-1/4	CTC-7X2801		159.34
RIPPER PIN PULLER.	1U3373	P-UB-10	1-1/2	4	CTC-7X2738		57.03
	8J2071	P-UB-10	1-1/2	4	CTC-7X2738		57.03
RIPPER TILT	3G2220	P-UB-10	3-1/4	8-1/4	CTC-7X2801		159.34
MODEL D10N							
DOZER LIFT	9T2869	P-UB-10	3-1/2	6-1/4	CTC-7X0863		110.22
DOZER TILT	9T1180	P-UB-10	4	9-1/4	CTC-7X2799		233.31
	9T4279	P-UB-10	4	9-1/4	CTC-7X2799		233.31
PIN PULLER	6E3113	P-UB-10	1-3/4	4	CTC-1316108		70.83
	9T2066	P-UB-10	1-1/2	4	CTC-7X2738		57.03
RIPPER	4T9977	P-UB-10	3-1/4	8-1/4	CTC-7X2715		172.78
RIPPER LH	4T5111	P-UB-10	3-1/4	9-1/4	CTC-7X2707		225.72
RIPPER LIFT LH	4T5111	P-UB-10	3-1/4	9-1/4	CTC-7X2707		225.72
RIPPER LIFT RH	4T5112	P-UB-10	3-1/4	9-1/4	CTC-7X2707		225.72
RIPPER PIN PULLER.	9T2066	P-UB-10	1-1/2	4	CTC-7X2738		57.03
RIPPER RH	4T5112	P-UB-10	3-1/4	9-1/4	CTC-7X2707		225.72
RIPPER TILT	4T9977	P-UB-10	3-1/4	8-1/4	CTC-7X2715		172.78
TILT LH	9J0673	P-UB-10	2-3/4	6	CTC-7X2803		111.76
TWIN TILT LH	9T9204	P-UB-10	4	9-1/4	CTC-7X2799		233.31
TWIN TILT RH	9T9203	P-UB-10	4	9-1/4	CTC-7X2799		233.31
MODEL D10R							
PIN PULLER	6E3113	P-UB-10	1-3/4	4	CTC-1316108		70.83
RIPPER	4T9977	P-UB-10	3-1/4	8-1/4	CTC-7X2715		172.78
RIPPER LH	4T5111	P-UB-10	3-1/4	9-1/4	CTC-7X2707		225.72
RIPPER RH	4T5112	P-UB-10	3-1/4	9-1/4	CTC-7X2707		225.72
MODEL D11N							
DOZER LIFT LH	4T2727	P-UB-10	4	7	CTC-1326783		169.39
	4T2727	P-UB-10	4	7	CTC-8T1457		125.26
DOZER LIFT RH	4T2728	P-UB-10	4	7	CTC-1326783		169.39
	4T2728	P-UB-10	4	7	CTC-8T1457		125.26
DOZER TILT	1U2711	P-UB-10	4	10-1/2	CTC-1324932		233.31
	9T1180	P-UB-10	4	9-1/4	CTC-7X2799		233.31
	9T4276	P-UB-10	4	9-1/4	CTC-7X2799		233.31
PIN PULLER	6E3113	P-UB-10	1-3/4	4	CTC-1316108		70.83
	6E3113	P-UB-10	1-1/2	4	CTC-7X2738		57.03
	9T2066	P-UB-10	1-1/2	4	CTC-7X2738		57.03
RIPPER	4T7985	P-UB-10	3-1/4	8-1/4	CTC-7X2715		172.78
RIPPER PIN PULLER.	9T2066	P-UB-10	1-1/2	4	CTC-7X2738		57.03
RIPPER TILT	3G2220	P-UB-10	3-1/4	8-1/4	CTC-7X2801		159.34
	3G3220	P-UB-10	3-1/4	8-1/4	CTC-7X2715		172.78

REPLACEMENT KITS FOR CATERPILLAR® EQUIPMENT

CATERPILLAR®

Track-Type Tractors							
APPLICATION	CYL #	CODE	ROD	BORE	KIT #	Misc-Serial #'s, Parts, etc.	List \$
MODEL D11N							
RIPPER TILT	4T7985	P-UB-10	3-1/4	8-1/4	CTC-7X2715		172.78
TILT	9T3715	P-UB-10	4	10-1/2	CTC-1324932		233.31
	9T3716	P-UB-10	4	10-1/2	CTC-1324932		233.31
MODEL D11R							
DOZER	1U2711	P-UB-10	4	10-1/2	CTC-1324932		233.31
DOZER LH	4T2727	P-UB-10	4	7	CTC-1326783		169.39
	4T2727	P-UB-10	4	7	CTC-8T1457		125.26
DOZER RH	4T2728	P-UB-10	4	7	CTC-1326783		169.39
	4T2728	P-UB-10	4	7	CTC-8T1457		125.26
PIN PULLER	6E3113	P-UB-10	1-3/4	4	CTC-1316108		70.83
	9T2066	P-UB-10	1-1/2	4	CTC-7X2738		57.03
TILT	9T3715	P-UB-10	4	10-1/2	CTC-1324932		233.31
	9T3716	P-UB-10	4	10-1/2	CTC-1324932		233.31
Tractors							
APPLICATION	CYL #	CODE	ROD	BORE	KIT #	Misc-Serial #'s, Parts, etc.	List \$
MODEL 772, 772B							
DOOR	3G4640	P-UB-14	2-1/2	6	CTC-7X2669		152.43
	9J8157	P-UB-14	2-1/2	6	CTC-7X2836		167.54
HOIST	9J2017	I-SP-10	5,7-1/2	8-1/4	CTC-8T9042		296.80
	9T3122	I-SP-10	5,7-1/2	8-1/4	CTC-8T9042		296.80
STEERING	7J7686	P-UB-10	2-3/8	4	CTC-8T1389		31.03
MODEL 776							
DOOR	3G4640	P-UB-14	2-1/2	6	CTC-7X2669		152.43
STEERING	8J9912	P-UB-10	2-3/8	4	CTC-8T1389		31.03
SUSPENSION REAR	8J8865	I, P-U-13	9	10-1/2	CTC-1137482		232.80
MODEL 784C							
STEERING	6E5857	P-UB-10	2-1/2	5	CTC-1304012		124.78
Tree Harvesters							
APPLICATION	CYL #	CODE	ROD	BORE	KIT #	Misc-Serial #'s, Parts, etc.	List \$
MODEL 518							
TILT LH	9T1777	P-UB-10	2-1/4	4-1/4	CTC-7X2750		74.60
TILT RH	9T1772	P-UB-10	2-1/4	4-1/4	CTC-7X2750		74.60
Wheel Loaders							
APPLICATION	CYL #	CODE	ROD	BORE	KIT #	Misc-Serial #'s, Parts, etc.	List \$
MODEL 902							
N/A	9T4006	P-UB-10	1-1/2	3	CTC-7X2737		70.81
MODEL 904							
LIFT	4T8580	P-UB-10	2	3-3/4	CTC-7X2787		58.89
STEERING	1U4666	P-UB-10	1-1/2	2-3/4	CTC-7X2749		38.50
TILT	4T8581	P-UB-10	1-3/4	3-1/4	CTC-7X2764		41.63
MODEL 906, 908							
N/A	9T4006	P-UB-10	1-1/2	3	CTC-7X2737	906 only	70.81
STEERING RH	1250373	P-UB-10	1-1/2	2-3/4	CTC-1361599		69.45
MODEL 910							
BUCKET	8J5391	P-UB-10	1-1/2	3-1/2	CTC-7X2752		62.21
LIFT	7J5893	P-UB-10	2	4	CTC-1328816		60.48
	7J5894	P-UB-10	2	4	CTC-1328816		60.48
STEERING	1U4666	P-UB-10	1-1/2	2-3/4	CTC-7X2736		82.41

REPLACEMENT KITS FOR CATERPILLAR® EQUIPMENT

CATERPILLAR®

Wheel Loaders							
APPLICATION	CYL #	CODE	ROD	BORE	KIT #	Misc-Serial #'s, Parts, etc.	List \$
MODEL 910							
STEERING	1U4666	P-UB-10	1-1/2	2-3/4	CTC-8T1402		32.69
	8J0070	P-UB-10	1-1/2	2-3/4	CTC-7X2749		38.50
	9T5153	P-UB-10	1-1/2	2-3/4	CTC-7X2736		82.41
	9T7209	P-UB-10	1-1/2	2-3/4	CTC-1361599		69.45
	9T7210	P-UB-10	1-1/2	2-3/4	CTC-1361599		69.45
STEERING LH	6E5973	P-UB-10	1-1/2	2-3/4	CTC-1361599		69.45
STEERING RH	6E5985	P-UB-10	1-1/2	2-3/4	CTC-1361599		69.45
TILT	1U3164	P-UB-10	1-3/4	3-1/4	CTC-7X2764		41.63
	1U3165	P-UB-10	1-3/4	3-1/4	CTC-1328770		78.69
	7J5885	P-UB-10	1-3/4	3	CTC-7X2791		57.77
	9J7905	P-UB-10	1-3/4	3	CTC-7X2791		57.77
TILT EXT'D DUMP	1U3164	P-UB-10	1-3/4	3-1/4	CTC-7X2764		41.63
TOOL BAR	4H6711	P-V-10	1-1/4	4	CTC-8T1480		53.94
MODEL 910E, 910F							
BUCKET	8J5391	P-UB-10	1-1/2	3-1/2	CTC-7X2752		62.21
STEERING	9T7209	P-UB-10	1-1/2	2-3/4	CTC-1361599		69.45
	9T7210	P-UB-10	1-1/2	2-3/4	CTC-1361599		69.45
STEERING LH	6E5900	P-UB-10	1-3/4	2-3/4	CTC-1539053		98.31
	6E5973	P-UB-10	1-1/2	2-3/4	CTC-1361599		69.45
STEERING RH	6E5985	P-UB-10	1-1/2	2-3/4	CTC-1361599		69.45
TILT	6E5966	P-UB-10	2-1/2	4-3/4	CTC-1361131	Rod Bearing width - 0.980"	107.38
MODEL 914							
M.P. BUCKET TILT	4T4666	P-UB-10	2-1/2	4	CTC-7X2665		108.85
MODEL 914G							
STEERING	9T8823	I-O-3	1	2	CTC-9T0418		54.12
MODEL 916							
BUCKET	3G7365	P-UB-10	1-1/2	3-1/2	CTC-7X2752		62.21
LIFT	4T8648	P-UB-10	2-1/4	4-1/4	CTC-7X2750		74.60
LIFT LH	3G6563	P-UB-10	2-1/4	4-1/4	CTC-7X2750		74.60
PIN PULLER	6E5393	I-O-3	1	2	CTC-9T0418		54.12
STEERING	1U3322	P-UB-10	1-1/2	3	CTC-7X2751		41.76
TILT	3G6571	P-UB-10	2-1/2	4-3/4	CTC-1328811		105.26
MODEL 918F, 924F							
LIFT	1342327	P-UB-10	2-1/4	4	CTC-1546526		98.29
	9T3937	P-UB-10	2-1/4	4	CTC-1546526		98.29
PIN PULLER	6E5393	I-O-3	1	2	CTC-9T0418	918F only	54.12
STEERING	9T2637	P-UB-10	1-1/2	2-3/4	CTC-1361599		69.45
TILT	1107845	P-UB-10	2-1/2	4-1/2	CTC-1113300		89.05
	1342671	P-UB-10	2-1/2	4-1/2	CTC-1113300		89.05
	6E4651	P-UB-10	2-1/2	4-1/2	CTC-1113300		89.05
MODEL 920							
BUCKET	7J6789	P-UB-10	2	4	CTC-7X2789		66.51
	8J5663	P-UB-10	2	4	CTC-7X2789		66.51
BUCKET LH	6J2806	P-UB-10	2	4	CTC-7X2789		66.51
BUCKET RH	6J2805	P-UB-10	2	4	CTC-7X2789		66.51
LIFT	3G5511	P-UB-10	2-1/4	4-1/4	CTC-7X2750		74.60
	3G5512	P-UB-10	2-1/4	4-1/4	CTC-7X2750		74.60
	6J8731	P-UB-10	2-1/4	4-1/4	CTC-7X2750		74.60

REPLACEMENT KITS FOR CATERPILLAR® EQUIPMENT

Wheel Loaders							
APPLICATION	CYL #	CODE	ROD	BORE	KIT #	Misc-Serial #'s, Parts, etc.	List \$
MODEL 920							
LIFT	6J8732	P-UB-10	2-1/4	4-1/4	CTC-7X2750		74.60
LIFT LH	7J9852	P-UB-10	2-1/4	4-1/4	CTC-7X2750		74.60
LIFT RH	7J9851	P-UB-10	2-1/4	4-1/4	CTC-7X2750		74.60
M.P. BUCKET LH	6J2806	P-UB-10	2	4	CTC-7X2789		66.51
M.P. BUCKET RH	6J2605	P-UB-10	2	4	CTC-7X2789		66.51
SIDE DUMP	8J5670	P-UB-10	2	4	CTC-7X2755		89.10
	8J5670	P-UB-10	2	4	CTC-7X7937		97.17
STEERING	6J5477	P-UB-10	1-1/2	3	CTC-7X2751		41.76
	7J9838	P-UB-10	1-1/2	3	CTC-1372530		58.90
	7J9838	P-UB-10	1-1/2	3	CTC-7X2751		41.76
TILT LH	3G5482	P-UB-10	2	4	CTC-1328816		60.48
	7J3052	P-UB-10	2	4	CTC-7X2789		66.51
	7J9676	P-UB-10	2	4	CTC-7X2789		66.51
TILT RH	3G5481	P-UB-10	2	4	CTC-1328816		60.48
	7J3051	P-UB-10	2	4	CTC-7X2789		66.51
	7J9675	P-UB-10	2	4	CTC-7X2789		66.51
MODEL 924							
M.P. BUCKET TILT	4T5545	P-UB-10	2-1/2	4-1/4	CTC-7X2663		32.21
MODEL 924G							
LIFT	1417483	P-UB-10	2-1/2	4	CTC-1542501		98.74
	9T8823	I-O-3	1	2	CTC-9T0418		54.12
MODEL 926							
BUCKET	4T9387	P-UB-10	2	4	CTC-1328816		60.48
LIFT	3G2991	P-UB-10	2-1/2	4-3/4	CTC-1328811		105.26
	3G2991	P-UB-10	2-1/2	4-3/4	CTC-7X2660		117.13
PIN PULLER	6E5393	I-O-3	1	2	CTC-9T0418		54.12
STEERING	3G3501	P-UB-10	1-1/2	3	CTC-7X2751		41.76
TILT	3G2798	P-UB-10	2-1/2	5-1/2	CTC-7X2671		96.59
	3G2798	P-UB-10	2-1/2	5-1/2	CTC-9X2047		70.55
MODEL 926E							
BUCKET	4T9387	P-UB-10	2	4	CTC-1328816		60.48
LIFT	3G2991	P-UB-10	2-1/2	4-3/4	CTC-1328811		105.26
	3G2991	P-UB-10	2-1/2	4-3/4	CTC-7X2660		117.13
STEERING	3G3501	P-UB-10	1-1/2	3	CTC-7X2751		41.76
	4T1574	P-UB-10	2	4	CTC-1328816		60.48
TILT	3G2798	P-UB-10	2-1/2	5-1/2	CTC-7X2671		96.59
	3G2798	P-UB-10	2-1/2	5-1/2	CTC-9X2047		70.55
MODEL 928F							
LIFT	1341383	P-UB-10	2-1/2	4-1/2	CTC-1113300		89.05
	6E1400	P-UB-10	2-1/2	4-1/2	CTC-1113300		89.05
PIN PULLER	6E5393	I-O-3	1	2	CTC-9T0418		54.12
STEERING	9T6646	P-UB-10	1-1/2	2-3/4	CTC-1361599		69.45
TILT	1341382	P-UB-10	2-1/2	4-3/4	CTC-1361131	Rod Bearing width - 0.980"	107.38
	9T6645	P-UB-10	2-1/2	4-3/4	CTC-1361131	Rod Bearing width - 0.980"	107.38
MODEL 928G							
LIFT	1191060	P-UB-10	2-1/2	4-3/4	CTC-1361131	Rod Bearing width - 0.980"	107.38
STEERING LH	1250374	P-UB-10	1-1/2	2-3/4	CTC-1361599		69.45
STEERING RH	1250373	P-UB-10	1-1/2	2-3/4	CTC-1361599		69.45

REPLACEMENT KITS FOR CATERPILLAR® EQUIPMENT

Wheel Loaders							
APPLICATION	CYL #	CODE	ROD	BORE	KIT #	Misc-Serial #'s, Parts, etc.	List \$
MODEL 928G							
TILT	1188105	P-UB-10	2-1/2	5	CTC-1361967		126.36
MODEL 930							
BUCKET	7J6789	P-UB-10	2	4	CTC-7X2789		66.51
	8J5663	P-UB-10	2	4	CTC-7X2789		66.51
BUCKET LH	6J2806	P-UB-10	2	4	CTC-7X2789		66.51
BUCKET RH	6J2805	P-UB-10	2	4	CTC-7X2789		66.51
LIFT	3G5471	P-UB-10	2-1/4	4-1/2	CTC-1326770		97.93
	4T0299	P-UB-10	2-1/4	4-1/2	CTC-7X2748		70.16
LIFT LH	7J9872	P-UB-10	2-1/4	4-1/2	CTC-7X2747		121.83
LIFT RH	7J9871	P-UB-10	2-1/4	4-1/2	CTC-7X2747		121.83
LOG FORK LH	8J5677	P-V-10	2	5	CTC-7X2763		88.32
LOG FORK RH	8J5676	P-V-10	2	5	CTC-7X2763		88.32
SIDE DUMP	8J5670	P-UB-10	2	4	CTC-7X2755		89.10
	8J5670	P-UB-10	2	4	CTC-7X7937		97.17
STEERING	7J9838	P-UB-10	1-1/2	3	CTC-1372530		58.90
	7J9838	P-UB-10	1-1/2	3	CTC-7X2751		41.76
TILT LH	7J9730	P-UB-10	2	4-1/4	CTC-7X2766		28.77
TILT RH	7J9729	P-UB-10	2	4-1/4	CTC-7X2766		28.77
MODEL 930R, 930T							
ARTICULATION	9T2447	P-UB-10	1-3/4	3	CTC-7X2825	930R only	32.51
LIFT LH	7J9872	P-UB-10	2-1/4	4-1/2	CTC-7X2747		121.83
LIFT RH	7J9871	P-UB-10	2-1/4	4-1/2	CTC-7X2747		121.83
STEERING	7J9838	P-UB-10	1-1/2	3	CTC-1372530		58.90
	7J9838	P-UB-10	1-1/2	3	CTC-7X2751		41.76
TILT LH	7J9730	P-UB-10	2	4-1/4	CTC-7X2766		28.77
TILT RH	7J9729	P-UB-10	2	4-1/4	CTC-7X2766		28.77
MODEL 936							
LIFT	3G2991	P-UB-10	2-1/2	4-3/4	CTC-7X2660		117.13
	4T1674	P-UB-10	2-1/2	5-1/2	CTC-7X2672		57.89
	9T1196	P-UB-10	2-1/2	5-1/2	CTC-7X2672		57.89
PIN COUPLER	4T9981	I-O-3	1	2	CTC-9T0418		54.12
	6E5392	I-O-3	1	2	CTC-9T0418		54.12
	6E5393	I-O-3	1	2	CTC-9T0418		54.12
	9T8485	I-O-3	1	2	CTC-9T0418		54.12
STEERING	3G5110	P-UB-10	1-3/4	3-1/2	CTC-7X2784		36.73
TILT	3G5291	P-UB-14	2-3/4	6-1/2	CTC-7X2686		78.72
MODEL 936E							
LIFT	3G2991	P-UB-10	2-1/2	4-3/4	CTC-7X2660		117.13
	4T0263	P-UB-10	2-1/2	4-3/4	CTC-7X2660		117.13
	4T0263	P-UB-10	2-1/2	4-3/4	CTC-7X2673		116.33
	4T1674	P-UB-10	2-1/2	5-1/2	CTC-7X2672		57.89
	9T1196	P-UB-10	2-1/2	5-1/2	CTC-7X2672		57.89
M.P. BUCKET	4T9387	P-UB-10	2	4	CTC-7X2789		66.51
M.P. BUCKET TILT	4T5545	P-UB-10	2-1/2	4-1/4	CTC-7X2663		32.21
PIN COUPLER	4T9981	I-O-3	1	2	CTC-9T0418		54.12
	9T2352	I-O-3	1	2	CTC-9T0418		54.12
	9T8485	I-O-3	1	2	CTC-9T0418		54.12
STEERING	3G3501	P-UB-10	1-1/2	3	CTC-7X2751		41.76

REPLACEMENT KITS FOR CATERPILLAR® EQUIPMENT

Wheel Loaders							
APPLICATION	CYL #	CODE	ROD	BORE	KIT #	Misc-Serial #'s, Parts, etc.	List \$
MODEL 936E							
STEERING	3G5110	P-UB-10	1-3/4	3-1/2	CTC-7X2784		36.73
TILT	3G5291	P-UB-14	2-3/4	6-1/2	CTC-7X2686		78.72
MODEL 936F							
LIFT	9T1196	P-UB-10	2-1/2	5-1/2	CTC-7X2672		57.89
PIN PULLER	6E5393	I-O-3	1	2	CTC-9T0418		54.12
STEERING	3G5110	P-UB-10	1-3/4	3-1/2	CTC-7X2784		36.73
	6E2035	P-UB-10	1-3/4	3-1/2	CTC-7X2784		36.73
TILT	3G5291	P-UB-14	2-3/4	6-1/2	CTC-7X2686		78.72
MODEL 938F							
LIFT	1287678	P-UB-10	2-1/2	5	CTC-1361967		126.36
	9T7160	P-UB-10	2-1/2	4-3/4	CTC-1361131	Rod Bearing width - 0.980"	107.38
STEERING	1050094	P-UB-10	1-3/4	3	CTC-7X2825		32.51
TILT	1377855	P-UB-10	2-3/4	5-1/2	CTC-1358736		138.27
	9T7161	P-UB-10	2-3/4	5-1/2	CTC-1358736		138.27
MODEL 938G							
LIFT	1287678	P-UB-10	2-1/2	5	CTC-1361967		126.36
STEERING	1050094	P-UB-10	1-3/4	3	CTC-7X2825		32.51
	1393312	P-UB-10	1-3/4	3	CTC-7X2825		32.51
TILT	1377855	P-UB-10	2-3/4	5-1/2	CTC-1358736		138.27
	9T7161	P-UB-10	2-3/4	5-1/2	CTC-1358736		138.27
MODEL 944, 944A							
LOG FORK LH	8J5677	P-V-10	2	5	CTC-7X2763		88.32
LOG FORK RH	8J5676	P-V-10	2	5	CTC-7X2763		88.32
MODEL 950							
LIFT	7J9690	P-UB-10	2-1/2	5-1/2	CTC-9X2050		65.65
LIFT LH	1U1147	P-UB-10	3	6	CTC-7X2698		121.48
LIFT RH	1U1148	P-UB-10	3	6	CTC-7X2698		121.48
LOG FORK LH	8J5677	P-V-10	2	5	CTC-7X2763		88.32
LOG FORK RH	8J5676	P-V-10	2	5	CTC-7X2763		88.32
SIDE DUMP	8J5690	P-V-10	2	5	CTC-7X2763		88.32
STEERING	3G0892	P-UB-10	1-3/4	3-1/2	CTC-7X2762		65.25
	3G0892	P-UB-10	1-3/4	3-1/2	CTC-7X2784		36.73
	7J9685	P-UB-10	1-1/2	3-1/2	CTC-7X2812		67.84
TILT	3G8786	P-UB-10	3-1/4	7	CTC-7X2704		92.22
	7J9695	P-UB-10	2-1/2	5-1/2	CTC-9X2050		65.65
TILT LH	7J9696	P-UB-10	2-1/2	5-1/2	CTC-9X2050		65.65
TILT RH	7J9363	P-UB-10	2-1/2	6	CTC-1363121		107.28
TREE HARVESTER DELIMBER	8J3829	P-UB-10	2	4	CTC-7X2789		66.51
	9J2481	P-UB-10	1-3/4	3	CTC-7X2791		57.77
MODEL 950B, 950E, 950F							
LIFT	4T0263	P-UB-10	2-1/2	4-3/4	CTC-1328811	950B & 950E only	105.26
	7J9902	P-UB-10	2	4-1/4	CTC-7X2819	950F only	68.55
LIFT LH	1U1147	P-UB-10	3	6	CTC-7X2698		121.48
LIFT RH	1U1148	P-UB-10	3	6	CTC-7X2698		121.48
STEERING	3G0892	P-UB-10	1-3/4	3-1/2	CTC-7X2784		36.73
	6E3889	P-UB-10	1-3/4	3-1/2	CTC-7X2784		36.73
	6E4892	P-UB-10	1-3/4	3-1/2	CTC-7X2784		36.73

REPLACEMENT KITS FOR CATERPILLAR® EQUIPMENT

Wheel Loaders							
APPLICATION	CYL #	CODE	ROD	BORE	KIT #	Misc-Serial #'s, Parts, etc.	List \$
MODEL 950B, 950E, 950F							
STEERING	6E5024	P-UB-10	2	4	CTC-1113302	950B & 950F only	77.57
TILT	3G8786	P-UB-10	3-1/4	7	CTC-1328518		149.50
MODEL 950B, 950E, 950F							
LIFT	4T0263	P-UB-10	2-1/2	4-3/4	CTC-7X2660		117.13
	4T0263	P-UB-10	2-1/2	4-3/4	CTC-7X2673		116.33
MODEL 950G							
LIFT RH	1188296	P-UB-10	3	6	CTC-7X2698		121.48
	1250024	P-UB-10	3	6	CTC-7X2698		121.48
STEERING	1188288	P-UB-10	1-3/4	3-1/2	CTC-7X2784		36.73
TILT	1189001	P-UB-10	3-1/4	7	CTC-7X2710		169.07
MODEL 960F							
LIFT	7J9902	P-UB-10	2	4-1/4	CTC-7X2819		68.55
LIFT LH	1U1147	P-UB-10	3	6	CTC-7X2698		121.48
LIFT RH	1U1148	P-UB-10	3	6	CTC-7X2698		121.48
STEERING	3G0892	P-UB-10	1-3/4	3-1/2	CTC-7X2784		36.73
	6E3889	P-UB-10	1-3/4	3-1/2	CTC-7X2784		36.73
	6E4892	P-UB-10	1-3/4	3-1/2	CTC-7X2784		36.73
TILT	3G8786	P-UB-10	3-1/4	7	CTC-1328518		149.50
MODEL 960G, 962G							
LIFT RH	1188296	P-UB-10	3	6	CTC-7X2698		121.48
	1250024	P-UB-10	3	6	CTC-7X2698		121.48
STEERING	1188288	P-UB-10	1-3/4	3-1/2	CTC-7X2784		36.73
TILT	1294447	P-UB-10	3-1/4	7	CTC-7X2710		169.07
MODEL 966							
LIFT	9J2434	P-UB-10	2-1/2	6-1/2	CTC-7X2666		110.77
LIFT LH	3G5495	P-UB-10	3-1/4	7	CTC-7X2710		169.07
LIFT RH	3G5496	P-UB-10	3-1/4	7	CTC-7X2710		169.07
STEERING	6E5024	P-UB-10	2	4	CTC-1113302		77.57
STEERING LH	7J9356	P-UB-10	2	4	CTC-7X2755		89.10
TILT	3G5497	P-UB-14	3-1/4	8-1/4	CTC-7X2703		153.70
TILT LH	7J9364	P-UB-14	2-1/2	6	CTC-7X2669		152.43
MODEL 966A							
LOG FORK LH	8J5677	P-V-10	2	5	CTC-7X2763		88.32
LOG FORK RH	8J5676	P-V-10	2	5	CTC-7X2763		88.32
SIDE DUMP	8J5733	P-V-10	2	5	CTC-7X2763		88.32
TILT LH	6J6874	P-UB-14	2-1/2	6	CTC-7X2669		152.43
	7J9364	P-UB-14	2-1/2	6	CTC-7X2669		152.43
	7J9364	P-UB-10	2-1/2	6	CTC-8T2066		68.96
TILT RH	6J6873	P-UB-14	2-1/2	6	CTC-7X2669		152.43
	7J9363	P-UB-14	2-1/2	6	CTC-7X2669		152.43
	7J9363	P-UB-10	2-1/2	6	CTC-8T2066		68.96
MODEL 966B							
LIFT	9J2434	P-UB-10	2-1/2	6-1/2	CTC-7X2666		110.77
LIFT RH	4J7859	P-UB-10	2	4	CTC-7X2755		89.10
LOG FORK	8J5755	P-UB-10	2-1/4	5	CTC-7X2729		105.87
LOG FORK LH	8J5677	P-V-10	2	5	CTC-7X2763		88.32
LOG FORK RH	8J5676	P-V-10	2	5	CTC-7X2763		88.32
SIDE DUMP	8J5733	P-V-10	2	5	CTC-7X2763		88.32

REPLACEMENT KITS FOR CATERPILLAR® EQUIPMENT

Wheel Loaders							
APPLICATION	CYL #	CODE	ROD	BORE	KIT #	Misc-Serial #'s, Parts, etc.	List \$
MODEL 966B							
SPECIAL APPLICATION	4J9996	P-UB-10	2-1/2	7-1/4	CTC-7X2661		117.98
STEERING LH	7J9356	P-UB-10	2	4	CTC-7X2755		89.10
STEERING RH	7J9355	P-UB-10	2	4	CTC-7X2755		89.10
TILT LH	6J6874	P-UB-14	2-1/2	6	CTC-7X2669		152.43
	7J9364	P-UB-14	2-1/2	6	CTC-7X2669		152.43
	7J9364	P-UB-10	2-1/2	6	CTC-8T2066		68.96
TILT RH	6J6873	P-UB-14	2-1/2	6	CTC-7X2669		152.43
	7J9363	P-UB-14	2-1/2	6	CTC-7X2669		152.43
	7J9363	P-UB-10	2-1/2	6	CTC-8T2066		68.96
MODEL 966C							
BUCKET TILT LH	5J2464	P-UB-10	2-1/2	6	CTC-8T2066		68.96
BUCKET TILT RH	5J2463	P-UB-10	2-1/2	6	CTC-8T2066		68.96
LIFT	3G5471	P-UB-10	2-1/4	4-1/2	CTC-1326770		97.93
	9J2434	P-UB-10	2-1/2	6-1/2	CTC-7X2666		110.77
LOG FORK	8J5755	P-UB-10	2-1/4	5	CTC-7X2729		105.87
LOG FORK LH	4K0502	P-V-10	2	5	CTC-7X2763		88.32
	8J5677	P-V-10	2	5	CTC-7X2763		88.32
LOG FORK RH	8J5676	P-V-10	2	5	CTC-7X2763		88.32
SIDE DUMP	8J5733	P-V-10	2	5	CTC-7X2763		88.32
SPECIAL APPLICATION	4J9996	P-UB-10	2-1/2	7-1/4	CTC-7X2661		117.98
STEERING LH	7J9356	P-UB-10	2	4	CTC-7X2755		89.10
STEERING RH	7J9355	P-UB-10	2	4	CTC-7X2755		89.10
TILT LH	6J6874	P-UB-14	2-1/2	6	CTC-7X2669		152.43
	7J9364	P-UB-14	2-1/2	6	CTC-7X2669		152.43
	7J9364	P-UB-10	2-1/2	6	CTC-8T2066		68.96
TILT RH	6J6873	P-UB-14	2-1/2	6	CTC-7X2669		152.43
	6J6873	P-UB-10	2-1/2	6	CTC-8T2066		68.96
	6J6875	P-UB-10	2-1/2	6	CTC-8T2066		68.96
	6J6876	P-UB-10	2-1/2	6	CTC-8T2066		68.96
	7J9363	P-UB-10	2-1/2	6	CTC-1363121		107.28
	7J9363	P-UB-14	2-1/2	6	CTC-7X2669		152.43
MODEL 966D							
LIFT	3G5495	P-UB-10	3-1/4	7	CTC-7X2710		169.07
LIFT RH	3G5496	P-UB-10	3-1/4	7	CTC-7X2710		169.07
STEERING	4T1574	P-UB-10	2	4	CTC-1328816		60.48
	6E4892	P-UB-10	1-3/4	3-1/2	CTC-7X2784		36.73
	6E5024	P-UB-10	2	4	CTC-1113302		77.57
	9J7061	P-UB-10	2	4	CTC-7X2789		66.51
TILT	3G5497	P-UB-14	3-1/4	8-1/4	CTC-7X2703		153.70
MODEL 966E, 966F							
LIFT	3G5495	P-UB-10	3-1/4	7	CTC-7X2710		169.07
LIFT RH	3G5496	P-UB-10	3-1/4	7	CTC-7X2710		169.07
STEERING	4T1574	P-UB-10	2	4	CTC-1328816		60.48
	6E5024	P-UB-10	2	4	CTC-1113302		77.57
	9J7061	P-UB-10	2	4	CTC-7X2789	966E only	66.51
TILT	3G5497	P-UB-14	3-1/4	8-1/4	CTC-7X2703		153.70
MODEL 966G, 972G							
LIFT LH	1332964	P-UB-10	3-1/4	7	CTC-7X2710		169.07

REPLACEMENT KITS FOR CATERPILLAR® EQUIPMENT

Wheel Loaders							
APPLICATION	CYL #	CODE	ROD	BORE	KIT #	Misc-Serial #'s, Parts, etc.	List \$
MODEL 966G, 972G							
LIFT RH	1332963	P-UB-10	3-1/4	7	CTC-7X2710		169.07
STEERING	1331747	P-UB-10	2	3-1/2	CTC-7X2783		67.15
MODEL 966R							
LIFT	9J2434	P-UB-10	2-1/2	6-1/2	CTC-7X2666		110.77
STEERING LH	7J9356	P-UB-10	2	4	CTC-7X2755		89.10
STEERING RH	7J9355	P-UB-10	2	4	CTC-7X2755		89.10
TILT LH	7J9364	P-UB-10	2-1/2	6	CTC-1363121		107.28
	7J9364	P-UB-14	2-1/2	6	CTC-7X2669		152.43
	7J9364	P-UB-10	2-1/2	6	CTC-8T2066		68.96
TILT RH	7J9363	P-UB-10	2-1/2	6	CTC-1363121		107.28
	7J9363	P-UB-14	2-1/2	6	CTC-7X2669		152.43
	7J9363	P-UB-10	2-1/2	6	CTC-8T2066		68.96
MODEL 970F							
LIFT LH	6E5879	P-UB-10	3-1/4	7	CTC-7X2710		169.07
LIFT RH	6E5878	P-UB-10	3-1/4	7	CTC-7X2710		169.07
STEERING	4T1574	P-UB-10	2	4	CTC-1328816		60.48
	6E5024	P-UB-10	2	4	CTC-1113302		77.57
TILT	3G5497	P-UB-14	3-1/4	8-1/4	CTC-7X2703		153.70
MODEL 980, 980B							
LIFT	7J9818	P-V-10	2-1/2	6-1/2	CTC-7X2678	980B only	71.34
	7J9818	P-UB-14	3	7-1/4	CTC-7X2699		140.39
LOG FORK	8J5767	P-UB-10	2-1/4	5	CTC-7X2729		105.87
STEERING LH	7J9786	P-UB-10	2-1/4	4-1/2	CTC-7X2747		121.83
STEERING RH	7J9785	P-UB-10	2-1/4	4-1/2	CTC-7X2747		121.83
TILT LH	7J9742	P-UB-10	2-1/2	5-1/2	CTC-9X2050		65.65
TILT RH	7J9741	P-UB-10	2-1/2	5-1/2	CTC-9X2050		65.65
MODEL 980C							
LIFT	9J5559	P-UB-14	3-1/2	7-1/2	CTC-7X2730		104.35
	9J8002	P-UB-10	2-3/4	5-1/2	CTC-7X2684		100.13
LIFT-DEEPER DIG	1U3527	P-UB-14	3-1/2	7-1/2	CTC-7X2730		104.35
LIFT-HIGH	4T6791	P-UB-14	3	6-1/4	CTC-7X2701		73.48
	4T7949	P-UB-14	3	6-1/4	CTC-7X2701		73.48
LOGGER TILT	3G5069	P-UB-14	2-3/4	7	CTC-7X2691		95.59
	3G5070	P-UB-14	2-3/4	7	CTC-7X2691		95.59
STEERING	6E6653	P-UB-10	2-1/4	4-1/2	CTC-1354392		101.01
STEERING LH	9J6536	P-UB-10	2-1/4	4-1/2	CTC-7X2747		121.83
STEERING RH	9J5869	P-UB-10	2-1/4	4-1/2	CTC-7X2747		121.83
TILT	1U0418	P-UB-10	3	5-1/2	CTC-7X2813		148.05
	9T2418	P-UB-14	3	6-1/4	CTC-7X2701		73.48
	9T2419	P-UB-14	3	6-1/4	CTC-7X2701		73.48
TILT LH	3G1306	P-UB-14	2-3/4	6-1/4	CTC-7X2688		80.56
	3G5070	P-UB-14	2-3/4	7	CTC-7X2691		95.59
	4T6791	P-UB-14	3	6-1/4	CTC-7X2701		73.48
	9T2419	P-UB-10	3	6-1/4	CTC-1328491		155.03
TILT RH	3G1305	P-UB-14	2-3/4	6-1/4	CTC-7X2688		80.56
	3G5069	P-UB-14	2-3/4	7	CTC-7X2691		95.59
	4T7949	P-UB-14	3	6-1/4	CTC-7X2701		73.48
	6E4866	P-UB-14	2-3/4	6-1/4	CTC-7X2688		80.56

REPLACEMENT KITS FOR CATERPILLAR® EQUIPMENT

Wheel Loaders							
APPLICATION	CYL #	CODE	ROD	BORE	KIT #	Misc-Serial #'s, Parts, etc.	List \$
MODEL 980C							
TILT RH	9T2418	P-UB-10	3	6-1/4	CTC-1328491		155.03
MODEL 980F							
LIFT	1U3527	P-UB-14	3-1/2	7-1/2	CTC-7X2730		104.35
STEERING	6E6653	P-UB-10	2-1/4	4-1/2	CTC-1354392		101.01
STEERING LH	9J6536	P-UB-10	2-1/4	4-1/2	CTC-7X2747		121.83
STEERING RH	9J5869	P-UB-10	2-1/4	4-1/2	CTC-7X2747		121.83
TILT LH	3G1306	P-UB-14	2-3/4	6-1/4	CTC-7X2688		80.56
	3G5070	P-UB-14	2-3/4	7	CTC-7X2691		95.59
	4T6791	P-UB-14	3	6-1/4	CTC-7X2701		73.48
	9T2419	P-UB-10	3	6-1/4	CTC-1328491		155.03
TILT RH	3G1305	P-UB-14	2-3/4	6-1/4	CTC-7X2688		80.56
	3G5069	P-UB-14	2-3/4	7	CTC-7X2691		95.59
	4T7949	P-UB-14	3	6-1/4	CTC-7X2701		73.48
	6E4866	P-UB-14	2-3/4	6-1/4	CTC-7X2688		80.56
	9T2418	P-UB-10	3	6-1/4	CTC-1328491		155.03
MODEL 980G							
LIFT	1118181	P-UB-10	3-1/2	7-3/4	CTC-1570284		187.09
STEERING	1151371	P-UB-10	2-1/4	4	CTC-1546526		98.29
TILT	1463032	P-UB-10	3	7	CTC-1605796		161.52
TILT LH	1125004	P-UB-14	2-3/4	6-1/4	CTC-7X2688		80.56
	1240617	P-UB-10	3	7	CTC-1605796		161.52
	1246227	P-UB-10	3	6-1/4	CTC-1328491		155.03
	1463035	P-UB-10	3	7	CTC-1605796		161.52
TILT RH	1125003	P-UB-14	2-3/4	6-1/4	CTC-7X2688		80.56
	1240616	P-UB-10	3	7	CTC-1605796		161.52
	1246228	P-UB-10	3	6-1/4	CTC-1328491		155.03
MODEL 988							
LIFT	4J7377	P-UB-10	3-1/4	8-1/4	CTC-7X2715		172.78
	7J9744	P-UB-14	3-1/4	8-1/4	CTC-7X2717		131.90
	9J4893	P-UB-14	3-1/4	8-1/4	CTC-7X2717		131.90
N/A	7K9401	P-UB-10	2-1/4	5	CTC-7X2729		105.87
STEERING	6J7590	P-UB-10	2-1/4	5	CTC-7X2729		105.87
	7J9718	P-UB-10	2-1/4	5	CTC-7X2729		105.87
	7J9984	P-UB-10	2-1/4	5	CTC-7X2729		105.87
TILT	9J3632	P-UB-10	3-1/4	7-3/4	CTC-7X2706		173.92
TILT LH	4J5744	P-UB-10	2-1/2	6-1/2	CTC-8T1376		51.87
	7J9762	P-UB-10	2-3/4	6-1/2	CTC-7X2689		105.00
TILT RH	4J5743	P-UB-10	2-1/2	6-1/2	CTC-8T1376		51.87
	7J9761	P-UB-10	2-3/4	6-1/2	CTC-7X2689		105.00
MODEL 988B							
BUCKET LIFT	9T8257	P-UB-14	4	8-1/2	CTC-7X2742		140.98
LIFT	1U4679	P-UB-10	4	8-1/2	CTC-7X2734		197.54
	4T7585	P-UB-14	4	8-1/2	CTC-7X2742		140.98
	8J5779	P-UB-10	4	8-1/2	CTC-7X2734		197.54
	9T8257	P-UB-14	4	8-1/2	CTC-7X2742		140.98
LOGGER TILT	3G2976	P-UB-10	3-1/2	8-1/2	CTC-7X2719		122.49
STEERING	5R4547	P-UB-10	2-1/4	5	CTC-9X6392		104.34
	9J8165	P-UB-10	2-1/4	5	CTC-9X6392		104.34

REPLACEMENT KITS FOR CATERPILLAR® EQUIPMENT

Wheel Loaders							
APPLICATION	CYL #	CODE	ROD	BORE	KIT #	Misc-Serial #'s, Parts, etc.	List \$
MODEL 988B							
TILT	3G2976	P-UB-10	3-1/2	8-1/2	CTC-7X2719		122.49
	4T6792	P-UB-10	3-1/2	7-3/4	CTC-1570284		187.09
	9J3632	P-UB-10	3-1/4	7-3/4	CTC-7X2706		173.92
MODEL 988F							
LIFT	9T8257	P-UB-14	4	8-1/2	CTC-7X2742		140.98
STEERING	9J8165	P-UB-10	2-1/4	5	CTC-9X6392		104.34
TILT	3G2976	P-UB-10	3-1/2	8-1/2	CTC-7X2719		122.49
	4T6792	P-UB-10	3-1/2	7-3/4	CTC-1570284		187.09
	9J3632	P-UB-10	3-1/4	7-3/4	CTC-7X2706		173.92
MODEL 990							
TILT LH	6E4835	P-UB-10	3-1/2	8-1/4	CTC-7X2721		189.85
TILT RH	6E4836	P-UB-10	3-1/2	8-1/4	CTC-7X2721		189.85
MODEL 992, 992B							
LIFT	7J8969	P-UB-14	6-1/2	10-1/2	CTC-8T1456		240.27
LIFT LH	7J8970	P-UB-14	6-1/2	10-1/2	CTC-8T1456		240.27
	8J5978	P-UB-14	6-1/2	10-1/2	CTC-8T1456		240.27
LIFT RH	8J5977	P-UB-14	6-1/2	10-1/2	CTC-8T1456		240.27
	7J9800	P-UB-10	2-1/2	5-1/2	CTC-8T1374		60.89
STEERING	8J6339	P-UB-10	2-1/2	5-1/2	CTC-7X2653		105.93
	8J6339	P-UB-10	2-1/2	5-1/2	CTC-8T1374		60.89
	9K5707	P-UB-10	2-1/2	5-1/2	CTC-8T1374		60.89
TILT LH	8J6338	P-UB-10	3-1/2	8-1/2	CTC-7X2719		122.49
TILT RH	8J6337	P-UB-10	3-1/2	8-1/2	CTC-7X2719		122.49
MODEL 992C							
LIFT	1U1771	P-UB-10	7	11-1/2	CTC-7X2809		270.30
	9J2994	P-UB-10	7	11-1/2	CTC-7X2809		270.30
LIFT HIGH	1U1771	P-UB-10	7	11-1/2	CTC-7X2809		270.30
	9J2994	P-UB-10	7	11-1/2	CTC-7X2809		270.30
STEERING	9J5419	P-UB-10	3-1/4	7	CTC-7X2710		169.07
TILT HIGH	1U1766	P-UB-14	4	10	CTC-7X2811		179.03
	1U1767	P-UB-14	4	10	CTC-7X2811		179.03
TILT LH	3G4599	P-UB-14	4	10	CTC-7X2810		150.52
TILT RH	3G4598	P-UB-14	4	10	CTC-7X2810		150.52
MODEL 992D							
LIFT	1028731	P-UB-10	7	11-1/2	CTC-7X2809		270.30
	1U1771	P-UB-10	7	11-1/2	CTC-7X2809		270.30
	9J2994	P-UB-10	7	11-1/2	CTC-7X2809		270.30
STEERING	9J5419	P-UB-10	3-1/4	7	CTC-7X2710		169.07
TILT LH	1026248	P-UB-14	4	10	CTC-7X2810		150.52
	1U1767	P-UB-14	4	10	CTC-7X2811		179.03
	3G4599	P-UB-14	4	10	CTC-7X2810		150.52
TILT RH	1026247	P-UB-14	4	10	CTC-7X2810		150.52
	1U1766	P-UB-14	4	10	CTC-7X2811		179.03
	3G4598	P-UB-14	4	10	CTC-7X2810		150.52
MODEL G910							
LIFT	7J5893	P-UB-10	2	4	CTC-1328816		60.48
	7J5894	P-UB-10	2	4	CTC-1328816		60.48
STEERING	1U4666	P-UB-10	1-1/2	2-3/4	CTC-7X2736		82.41

REPLACEMENT KITS FOR CATERPILLAR® EQUIPMENT

Wheel Loaders							
APPLICATION	CYL #	CODE	ROD	BORE	KIT #	Misc-Serial #'s, Parts, etc.	List \$
MODEL G910							
STEERING	1U4666	P-UB-10	1-1/2	2-3/4	CTC-8T1402		32.69
TILT	1U3165	P-UB-10	1-3/4	3-1/4	CTC-1328770		78.69
	1U4666	P-UB-10	1-1/2	2-3/4	CTC-7X2749		38.50
	7J5885	P-UB-10	1-3/4	3	CTC-7X2791		57.77
	7J5893	P-UB-10	2	4	CTC-7X2789		66.51
	7J5894	P-UB-10	2	4	CTC-7X2789		66.51
MODEL G916							
LIFT	4T8648	P-UB-10	2-1/4	4-1/4	CTC-7X2750		74.60
PIN PULLER	6E5393	I-O-3	1	2	CTC-9T0418		54.12
STEERING	1U3322	P-UB-10	1-1/2	3	CTC-7X2751		41.76
TILT	3G6571	P-UB-10	2-1/2	4-3/4	CTC-1328811		105.26
MODEL G926							
LIFT	3G2991	P-UB-10	2-1/2	4-3/4	CTC-1328811		105.26
	3G2991	P-UB-10	2-1/2	4-3/4	CTC-7X2660		117.13
PIN PULLER	6E5393	I-O-3	1	2	CTC-9T0418		54.12
STEERING	3G3501	P-UB-10	1-1/2	3	CTC-7X2751		41.76
TILT	3G2798	P-UB-10	2-1/2	5-1/2	CTC-8T3576		58.92
	3G2798	P-UB-10	2-1/2	5-1/2	CTC-9X2047		70.55
MODEL G936							
LIFT	4T1674	P-UB-10	2-1/2	5-1/2	CTC-7X2672		57.89
	9T1196	P-UB-10	2-1/2	5-1/2	CTC-7X2672		57.89
PIN PULLER	6E5393	I-O-3	1	2	CTC-9T0418		54.12
STEERING	3G5110	P-UB-10	1-3/4	3-1/2	CTC-7X2784		36.73
TILT	3G5291	P-UB-14	2-3/4	6-1/2	CTC-7X2686		78.72
Wheel Tractors							
APPLICATION	CYL #	CODE	ROD	BORE	KIT #	Misc-Serial #'s, Parts, etc.	List \$
MODEL 814							
BLADE TIP	1U4744	P-UB-10	2	4	CTC-7X2755		89.10
DOZER	7J7028	P-UB-10	2-1/2	4-3/4	CTC-7X2773		116.33
LIFT	1U2088	P-UB-10	2-1/2	4-3/4	CTC-7X2660		117.13
LIFT RH	4J7859	P-UB-10	2	4	CTC-7X2755		89.10
STEERING	4T1574	P-UB-10	2	4	CTC-1328816		60.48
STEERING LH	7J9356	P-UB-10	2	4	CTC-7X2755		89.10
STEERING RH	7J9355	P-UB-10	2	4	CTC-7X2755		89.10
TILT	7J7295	P-UB-10	2	4-1/2	CTC-7X2768		57.83
MODEL 814B							
BLADE TIP	1U4744	P-UB-10	2	4	CTC-7X2755		89.10
DOZER	1U2088	P-UB-10	2-1/2	4-3/4	CTC-1328811		105.26
DOZER LIFT	1U2088	P-UB-10	2-1/2	4-3/4	CTC-7X2660		117.13
	7J7028	P-UB-10	2-1/2	4-3/4	CTC-7X2660		117.13
STEERING	4T1574	P-UB-10	2	4	CTC-1328816		60.48
	6E5024	P-UB-10	2	4	CTC-1113302		77.57
TILT	7J7295	P-UB-10	2	4-1/2	CTC-7X2768		57.83
MODEL 814F							
DOZER	1U2088	P-UB-10	2-1/2	4-3/4	CTC-1328811		105.26
STEERING	4T1574	P-UB-10	2	4	CTC-1328816		60.48
	6E5024	P-UB-10	2	4	CTC-1113302		77.57

REPLACEMENT KITS FOR CATERPILLAR® EQUIPMENT

Wheel Tractors							
APPLICATION	CYL #	CODE	ROD	BORE	KIT #	Misc-Serial #'s, Parts, etc.	List \$
MODEL 814S							
BLADE TIP	1U4744	P-UB-10	2	4	CTC-7X2755		89.10
TILT	7J7295	P-UB-10	2	4-1/2	CTC-7X2768		57.83
MODEL 824							
BLADE TIP	4J5632	P-V-10	2-1/2	6-1/2	CTC-7X2678		71.34
	4J6006	P-UB-10	2-1/2	6	CTC-7X2656	Application requires 2 kits.	105.15
	4J6006	P-UB-10	2-1/2	6	CTC-7X2692	Application requires 2 kits.	107.12
BLADE TIP LH	4J4498	P-UB-10	2-1/2	6	CTC-7X2656		105.15
LIFT	3J9307	P-V-10	2-1/2	6-1/2	CTC-7X2676		71.34
	4J6005	P-V-10	2-1/2	6-1/2	CTC-7X2676		71.34
	4J7621	P-V-10	2-1/2	6-1/2	CTC-7X2676		71.34
	4J9233	P-V-10	2	4-1/2	CTC-7X2770		63.86
	6J1269	P-V-10	2-1/2	6-1/2	CTC-7X2676		71.34
	6J1272	P-V-10	2-1/2	6-1/2	CTC-7X2676		71.34
	6J1273	P-V-10	2-1/2	6-1/2	CTC-7X2676		71.34
	9J7111	P-UB-10	2-1/2	5-1/2	CTC-7X2653		105.93
STEERING	7J9984	P-UB-10	2-1/4	5	CTC-7X2729		105.87
STEERING LH	9J7087	P-UB-10	2-1/4	5	CTC-7X2729		105.87
STEERING RH	9J7086	P-UB-10	2-1/4	5	CTC-7X2729		105.87
TILT RH	4J4497	P-V-10	2-1/2	6-1/2	CTC-7X2678		71.34
MODEL 824B							
BLADE LH	4J4498	P-UB-10	2-1/2	6	CTC-7X2656		105.15
BLADE TIP	4J6006	P-UB-10	2-1/2	6	CTC-7X2656	Application requires 2 kits.	105.15
BLADE TIP LH	4J4498	P-UB-10	2-1/2	6	CTC-7X2656		105.15
LIFT	3J9307	P-V-10	2-1/2	6-1/2	CTC-7X2676		71.34
	4J6005	P-V-10	2-1/2	6-1/2	CTC-7X2676		71.34
	4J7621	P-V-10	2-1/2	6-1/2	CTC-7X2676		71.34
	4J9233	P-V-10	2	4-1/2	CTC-7X2770		63.86
	6J1269	P-V-10	2-1/2	6-1/2	CTC-7X2676		71.34
	6J1272	P-V-10	2-1/2	6-1/2	CTC-7X2676		71.34
	6J1273	P-V-10	2-1/2	6-1/2	CTC-7X2676		71.34
	9J7111	P-UB-10	2-1/2	5-1/2	CTC-7X2653		105.93
STEERING	6J7590	P-UB-10	2-1/4	5	CTC-7X2729		105.87
	7J9718	P-UB-10	2-1/4	5	CTC-7X2729		105.87
	7J9984	P-UB-10	2-1/4	5	CTC-7X2729		105.87
STEERING LH	9J7087	P-UB-10	2-1/4	5	CTC-7X2729		105.87
STEERING RH	9J7086	P-UB-10	2-1/4	5	CTC-7X2729		105.87
TILT RH	4J4497	P-V-10	2-1/2	6-1/2	CTC-7X2678		71.34
MODEL 824C							
BLADE LH	4J4498	P-UB-10	2-1/2	6	CTC-7X2656		105.15
BLADE RH	4J4497	P-V-10	2-1/2	6-1/2	CTC-7X2678		71.34
BLADE TIP	4J4497	P-V-10	2-1/2	6-1/2	CTC-7X2678		71.34
	4J5632	P-V-10	2-1/2	6-1/2	CTC-7X2678		71.34
	4J6006	P-UB-10	2-1/2	6	CTC-7X2656	Application requires 2 kits.	105.15
BLADE TIP LH	4J4498	P-UB-10	2-1/2	6	CTC-7X2656		105.15
LIFT	4J6005	P-V-10	2-1/2	6-1/2	CTC-7X2676		71.34
	6J1269	P-V-10	2-1/2	6-1/2	CTC-7X2676		71.34
	6J1272	P-V-10	2-1/2	6-1/2	CTC-7X2676		71.34
	6J1273	P-V-10	2-1/2	6-1/2	CTC-7X2676		71.34

REPLACEMENT KITS FOR CATERPILLAR® EQUIPMENT



Wheel Tractors							
APPLICATION	CYL #	CODE	ROD	BORE	KIT #	Misc-Serial #'s, Parts, etc.	List \$
MODEL 824C							
LIFT	9J7111	P-UB-10	2-1/2	5-1/2	CTC-7X2653		105.93
LIFT LH	4J4498	P-UB-10	2-1/2	6	CTC-7X2656		105.15
STEERING LH	9J7087	P-UB-10	2-1/4	5	CTC-9X6392		104.34
STEERING RH	9J7086	P-UB-10	2-1/4	5	CTC-9X6392		104.34
MODEL 824S, 834S, 834U							
LIFT LH	4J4498	P-UB-10	2-1/2	6	CTC-7X2656		105.15
TILT RH	4J4497	P-V-10	2-1/2	6-1/2	CTC-7X2678		71.34
MODEL 830M							
DOZER LIFT	3R4109	P-UB-10	2-1/2	4-3/4	CTC-7X2660		117.13
LIFT	3J6439	P-UB-10	2-1/2	6	CTC-7X2679		90.10
RIPPER LIFT	3R6724	P-UB-10	2-1/2	6	CTC-7X2679		90.10
STEERING	5R0062	P-UB-10	2-1/4	5	CTC-7X2729		105.87
	7J9984	P-UB-10	2-1/4	5	CTC-7X2729		105.87
MODEL 834							
BLADE LH	4J4498	P-UB-10	2-1/2	6	CTC-7X2656		105.15
BLADE TIP	4J5632	P-V-10	2-1/2	6-1/2	CTC-7X2678		71.34
	4J6006	P-UB-10	2-1/2	6	CTC-7X2656	Application requires 2 kits.	105.15
LIFT	4J6005	P-V-10	2-1/2	6-1/2	CTC-7X2676		71.34
	4J7621	P-V-10	2-1/2	6-1/2	CTC-7X2676		71.34
	4J9233	P-V-10	2	4-1/2	CTC-7X2770		63.86
	6J1269	P-V-10	2-1/2	6-1/2	CTC-7X2676		71.34
	6J1272	P-V-10	2-1/2	6-1/2	CTC-7X2676		71.34
STEERING	7J9984	P-UB-10	2-1/4	5	CTC-7X2729		105.87
	9J8165	P-UB-10	2-1/4	5	CTC-9X6392		104.34
TILT RH	4J4497	P-V-10	2-1/2	6-1/2	CTC-7X2678		71.34
MODEL 834B							
BLADE LH	4J4498	P-UB-10	2-1/2	6	CTC-7X2656		105.15
BLADE TIP	4J5632	P-V-10	2-1/2	6-1/2	CTC-7X2678		71.34
LIFT	4J7621	P-V-10	2-1/2	6-1/2	CTC-7X2676		71.34
	6J1272	P-V-10	2-1/2	6-1/2	CTC-7X2676		71.34
LIFT LH	4J4498	P-UB-10	2-1/2	6	CTC-7X2656		105.15
STEERING	9J8165	P-UB-10	2-1/4	5	CTC-9X6392		104.34
TILT RH	4J4497	P-V-10	2-1/2	6-1/2	CTC-7X2678		71.34
TIP	4J6006	P-UB-10	2-1/2	6	CTC-7X2656	Application requires 2 kits.	105.15
MODEL 834C							
BLADE TIP	4J5632	P-V-10	2-1/2	6-1/2	CTC-7X2678		71.34
	4J6006	P-UB-10	2-1/2	6	CTC-7X2656	Application requires 2 kits.	105.15



REPLACEMENT KITS FOR CATERPILLAR® EQUIPMENT

IMPORTANT – PLEASE READ

If a kit part number is unknown, the machine model number, serial number, and cylinder application will help identify the repair kit you need.

Example: Model Number **D5**
Serial Number **63J806**
Cylinder Application **Dozer Lift**

If none of the above information is known, size and description of the parts needed will almost always be sufficient.

NOTE: Caterpillar® kit numbers are used as a reference only. We do not imply that these kits are original REPLACEMENT KITS.

Kit Number	Code (Pg. x)	Rod X Bore Size	List Price	Kit Number	Code (Pg. x)	Rod X Bore Size	List Price
CTC-FIG0401	TRACK ADJUSTER KIT		\$ 61.14	CTC-1057480	P-UB-14	55 X 100 mm	\$ 137.76
CTC-FIG0402	TRACK ADJUSTER KIT		72.04	CTC-1113300	P-UB-10	2-1/2 X 4-1/2	89.05
CTC-FIG0405	TRACK ADJUSTER KIT		64.65	CTC-1113301	P-UB-10	1-7/8 X 3	200.31
CTC-FIG1401	TRACK ADJUSTER KIT		53.75	CTC-1113302	P-UB-10	2 X 4	77.57
CTC-FIG1402	TRACK ADJUSTER KIT		78.64	CTC-1125343	I-SP-10, 3	8-3/4, 12-1/2 X 11, 13-3/4	743.35
CTC-FIG2400	TRACK ADJUSTER KIT		50.10	CTC-1126550	P-UB-10	3 X 6-1/2	115.57
CTC-FIG3400	TRACK ADJUSTER KIT		39.01	CTC-1131073	I,P-U-3	12 X 15-1/8	2406.52
CTC-FIG3401	TRACK ADJUSTER KIT		36.41	CTC-1132693	I-U-3	1-1/4 X 2-1/2	10.90
CTC-FIG3404	TRACK ADJUSTER KIT		26.14	CTC-1137472	I,P-U-3	13-1/2 X 16-1/8	2428.85
CTC-FIG4400	TRACK ADJUSTER KIT		31.32	CTC-1137476	I,P-U-3	11 X 13-1/8	2140.00
CTC-FIG4405	TRACK ADJUSTER KIT		14.59	CTC-1137480	I,P-U-3	12-1/2 X 14-1/4	591.70
BD-711436	I-U-3	11 X 13-1/8	2057.46	CTC-1137482	I-UB-3	9 X 10-1/2	232.81
BD-712436	P-U-3	11 X 13-1/8	2111.33	CTC-1148290	P-UB-10	80 X 120 mm	132.33
BD-713437	I-U-3	11 X 12-1/2	332.46	CTC-1148526	P-UB-10	75 X 110 mm	156.37
BD-714437	P-U-3	11 X 12-1/2	386.33	CTC-1163612	P-UB-10	105 X 150 mm	196.77
BD-715438	I-SP-10, 3	7-1/4, 10-1/2 X 9-1/4, 11-1/2	508.86	CTC-1163649	P-UB-10	110 X 170 mm	245.59
BD-716439	I-SP-10, 3	7-1/4, 11 X 9-1/2, 12-1/4	640.39	CTC-1180672	I-U-10	6 X 8-1/4	426.98
BD-717440	I-U-3	12-1/2 X 15-1/8	2320.26	CTC-1183946	P-UB-10	110 X 160 mm	237.82
BD-718440	P-U-3	12-1/2 X 15-1/8	2230.16	CTC-1184024	P-UB-10	100 X 140 mm	212.25
BD-719441	I-U-3	12-1/2 X 14-1/4	505.46	CTC-1184131	P-UB-10	85 X 120 mm	162.94
BD-720441	P-U-3	12-1/2 X 14-1/4	415.34	CTC-1184175	P-UB-10	90 X 130 mm	192.55
BD-7751023	I-U-3	13-1/2 X 16-1/8	2340.32	CTC-1186023	P-UB-10	85 X 120 mm	173.68
BD-7761023	P-U-3	13-1/2 X 16-1/8	2383.07	CTC-1195435	P-UB-10	75 X 110 mm	192.66
BD-7771024	I-SP-10, 3	8-3/4, 12-1/2 X 11, 13-3/4	743.35	CTC-1195446	P-UB-10	80 X 120 mm	175.76
BD-7791025	I-SP-10, 3	7-3/4, 11-1/2 X 10, 12-1/2	546.43	CTC-1195457	P-UB-10	65 X 100 mm	139.89
CTC-0875387	P-UB-10	100 X 140 mm	222.80	CTC-1261887	P-UB-10	90 X 130 mm	278.90
CTC-0875394	P-UB-10	85 X 120 mm	168.75	CTC-1261947	P-UB-10	85 X 120 mm	225.72
CTC-0875407	P-UB-10	130 X 180 mm	259.63	CTC-1261979	P-UB-10	130 X 190 mm	191.93
CTC-0876654	P-UB-10	110 X 160 mm	209.31	CTC-1270630	P-UB-10	100 X 140 mm	221.82
CTC-0901523	2-1/2, 3-1/4, 4	MULTI-STAGE	82.74	CTC-1270631	P-UB-10	100 X 140 mm	223.32
CTC-0919842	P-U-14	45 X 90 mm	52.08	CTC-1270795	P-UB-10	2-1/2 X 5	77.28
CTC-0995401	P-UB-14	70 X 100 mm	151.40	CTC-1279809	P-UB-10	3 X 6-1/2	150.95
CTC-1002931	P-UB-10	3-1/4 X 5-1/2	258.51	CTC-1289277	P-UB-10	105 X 150 mm	239.94
CTC-1002932	P-UB-10	3-1/4 X 5-1/2	258.82	CTC-1289278	P-UB-10	110 X 170 mm	259.07
CTC-1002934	P-UB-10	4-1/4 X 6-1/2	262.07	CTC-1289280	P-UB-10	110 X 160 mm	251.28
CTC-1002935	P-UB-10	4-1/4 X 6-1/2	266.77	CTC-1304012	P-UB-10	2-1/2 X 5	124.78
CTC-1002939	P-UB-10	3-3/4 X 6	319.47	CTC-1305923	P-UB-10	2-1/8 X 4	103.38
CTC-1014201	P-UB-10	2-1/2 X 4-3/4	87.37	CTC-1315106	P-UB-10	2-1/2 X 5	110.14
CTC-1016061	I-U-10	30 X 63 mm	82.15	CTC-1315118	P-UB-10	2-1/2 X 5	116.01
CTC-1038333	P-UB-14	60 X 90 mm	161.61	CTC-1315164	P-UB-10	2-1/2 X 6	132.66
CTC-1040763	P-U-1	70 mm Rod Kit	35.55	CTC-1315423	P-UB-10	3 X 4	138.80
CTC-1041023	P-U-1	75 mm Rod Kit	33.59	CTC-1316108	P-UB-10	1-3/4 X 4	70.84
CTC-1045008	I-U-10	4 X 4-1/2	181.54	CTC-1318700	P-UB-10	2-1/2 X 3-3/4	98.42
CTC-1052585	P-UB-10	90 X 130 mm	315.67	CTC-1318733	P-UB-10	3 X 6-1/2	134.41
CTC-1052601	P-UB-10	85 X 130 mm	282.61	CTC-1318740	P-UB-10	3 X 6-1/2	113.01
CTC-1057253	P-UB-14	55 X 80 mm	120.45	CTC-1318748	P-UB-10	2-1/2 X 4	100.39
CTC-1057255	P-UB-14	75 X 110 mm	177.44	CTC-1326127	P-UB-10	3 X 7-1/4	135.63
CTC-1057359	P-UB-10	80 X 100 mm	159.86	CTC-1326148	P-UB-10	2-3/4 X 4-1/4	111.86
CTC-1057379	P-UB-10	85 X 120 mm	169.02	CTC-1326184	P-UB-10	3 X 7-1/4	147.30
CTC-1057397	P-UB-10	70 X 100 mm	132.22	CTC-1326770	P-UB-10	2-1/4 X 4-1/2	97.93

REPLACEMENT KITS FOR CATERPILLAR® EQUIPMENT

NOTE: Caterpillar® kit numbers are used as a reference only. We do not imply that these kits are original REPLACEMENT KITS.

Kit Number	Code (Pg. x)	Rod X Bore Size	List Price	Kit Number	Code (Pg. x)	Rod X Bore Size	List Price
CTC-7U2486	I-U-10	4 X 4-1/2	\$ 210.54	CTC-7X2710	P-UB-10	3-1/2 X 7	\$ 169.07
CTC-7U8075	I-U-10	2-3/4 X 4	166.98	CTC-7X2711	P-UB-10	3-1/4 X 6-1/2	136.74
CTC-7U9545	I-UB-5	2 X 4-1/2	201.48	CTC-7X2712	P-UB-10	3-1/4 X 5-1/2	60.42
CTC-7X0863	P-UB-10	3-1/2 X 6-1/4	110.23	CTC-7X2713	P-UB-14	3-1/4 X 6-1/2	87.15
CTC-7X2451	P-UB-10	2-3/4 X 4-1/4	72.31	CTC-7X2714	P-UB-14	3-1/4 X 5-1/2	105.34
CTC-7X2653	P-UB-10	2-1/2 X 5-1/2	105.94	CTC-7X2715	P-UB-10	3-1/4 X 8-1/4	172.78
CTC-7X2655	P-UB-10	2-1/2 X 6	74.09	CTC-7X2716	P-UB-10	3-1/4 X 9-1/4	104.07
CTC-7X2656	P-UB-10	2-1/2 X 6	105.15	CTC-7X2717	P-UB-14	3-1/4 X 8-1/4	131.91
CTC-7X2658	P-UB-10	2-1/2 X 5	113.62	CTC-7X2718	P-UB-10	3-1/4 X 7-1/4	129.55
CTC-7X2659	P-UB-10	2-1/2 X 4	102.23	CTC-7X2719	P-UB-10	3-1/2 X 8-1/2	122.49
CTC-7X2660	P-UB-10	2-1/2 X 4-3/4	117.13	CTC-7X2720	P-UB-10	3-1/2 X 8-1/4	117.82
CTC-7X2660A	P-UB-10	2-1/2 X 4-3/4	110.34	CTC-7X2721	P-UB-10	3-1/2 X 8-1/4	189.86
CTC-7X2661	P-UB-10	2-1/2 X 7-1/4	117.99	CTC-7X2722	P-UB-10	3-1/2 X 7-1/2	121.13
CTC-7X2662	P-UB-10	2-1/2 X 6	111.69	CTC-7X2724	P-UB-14	3-1/2 X 8-1/4	132.50
CTC-7X2663	P-UB-10	2-1/2 X 4-1/4	32.21	CTC-7X2725	P-UB-10	3-1/2 X 8-1/4	253.73
CTC-7X2664	P-UB-10	2-1/2 X 4-1/4	58.30	CTC-7X2726	P-UB-14	3-1/2 X 5-1/2	98.05
CTC-7X2665	P-UB-10	2-1/2 X 4	108.85	CTC-7X2727	P-UB-14	3-1/2 X 8-1/4	224.54
CTC-7X2666	P-UB-10	2-1/2 X 6-1/2	110.77	CTC-7X2728	P-UB-10	3-1/2 X 8-1/4	114.09
CTC-7X2667	P-UB-10	2-1/2 X 4-1/2	62.31	CTC-7X2729	P-UB-10	2-1/4 X 5	105.87
CTC-7X2668	P-UB-10	2-1/2 X 4-1/2	110.89	CTC-7X2730	P-UB-14	3-1/2 X 7-1/2	104.36
CTC-7X2669	P-UB-14	2-1/2 X 6	152.44	CTC-7X2731	P-UB-10	3-3/4 X 6-1/2	168.93
CTC-7X2670	P-UB-10	2-1/2 X 3-3/4	59.75	CTC-7X2734	P-UB-10	4 X 8-1/2	197.54
CTC-7X2671	P-UB-10	2-1/2 X 5-1/2	96.60	CTC-7X2736	P-UB-10	1-1/2 X 2-3/4	82.42
CTC-7X2672	P-UB-10	2-1/2 X 5-1/2	57.90	CTC-7X2737	P-UB-10	1-1/2 X 3	70.82
CTC-7X2673	P-UB-10	2-1/2 X 4-3/4	116.34	CTC-7X2738	P-UB-10	1-1/2 X 4	57.04
CTC-7X2674	P-UB-10	2-1/2 X 6	84.27	CTC-7X2739	P-UB-10	1-1/2 X 2-1/2	36.87
CTC-7X2675	P-UB-10	2-1/2 X 5	81.03	CTC-7X2741	P-UB-10	1-1/2 X 3-1/4	47.27
CTC-7X2676	P-V-10	2-1/2 X 6-1/2	71.35	CTC-7X2742	P-UB-14	4 X 8-1/2	140.98
CTC-7X2677	P-V-10	2 X 4-3/4	76.32	CTC-7X2743	P-UB-10	2-1/2 X 5	73.26
CTC-7X2678	P-V-10	2-1/2 X 6-1/2	71.35	CTC-7X2745	P-UB-10	1-1/2 X 3	70.82
CTC-7X2679	P-UB-10	2-1/2 X 6	90.10	CTC-7X2747	P-UB-10	2-1/4 X 4-1/2	121.84
CTC-7X2680	P-UB-10	2-3/4 X 6	89.34	CTC-7X2748	P-UB-10	2-1/4 X 4-1/2	70.16
CTC-7X2681	P-UB-10	2-3/4 X 7-1/4	74.08	CTC-7X2749	P-UB-10	1-1/2 X 2-3/4	38.51
CTC-7X2682	P-UB-10	2-3/4 X 5	101.82	CTC-7X2750	P-UB-10	2-1/4 X 4-1/4	74.60
CTC-7X2683	P-UB-14	2-3/4 X 4-1/2	119.14	CTC-7X2751	P-UB-10	1-1/2 X 3	41.76
CTC-7X2684	P-UB-10	2-3/4 X 5-1/2	100.14	CTC-7X2752	P-UB-10	1-1/2 X 3-1/2	62.21
CTC-7X2685	P-UB-14	2-3/4 X 4-1/2	107.10	CTC-7X2753	P-UB-10	2 X 3	38.58
CTC-7X2686	P-UB-14	2-3/4 X 6-1/2	78.73	CTC-7X2755	P-UB-10	2 X 4	89.10
CTC-7X2687	P-UB-10	2-3/4 X 7-1/4	173.72	CTC-7X2755A	P-UB-10	2 X 4	61.66
CTC-7X2688	P-UB-14	2-3/4 X 6-1/4	80.56	CTC-7X2756	P-UB-10	3 X 5-1/4	82.45
CTC-7X2689	P-UB-10	2-3/4 X 6-1/2	105.00	CTC-7X2757	P-UB-10	3-1/4 X 6	174.51
CTC-7X2690	P-UB-10	2-3/4 X 5-1/2	64.91	CTC-7X2760	P-UB-10	2 X 3	41.93
CTC-7X2691	P-UB-14	2-3/4 X 7	95.59	CTC-7X2762	P-UB-10	1-3/4 X 3-1/2	65.25
CTC-7X2692	P-UB-10	2-1/2 X 6	107.12	CTC-7X2763	P-V-10	2 X 5	88.33
CTC-7X2694	P-UB-10	3 X 6-1/2	103.59	CTC-7X2764	P-UB-10	1-3/4 X 3-1/4	41.64
CTC-7X2695	P-UB-10	3 X 8-1/4	231.80	CTC-7X2765	P-UB-14	4 X 6-1/2	153.70
CTC-7X2697	P-UB-10	3 X 6-1/4	103.15	CTC-7X2766	P-UB-10	2 X 4-1/4	28.78
CTC-7X2698	P-UB-10	3 X 6	121.49	CTC-7X2767	P-UB-10	2 X 3-1/4	41.87
CTC-7X2699	P-UB-14	3 X 7-1/4	140.40	CTC-7X2768	P-UB-10	2 X 4-1/2	57.83
CTC-7X2700	P-V-10	2 X 4-1/2	46.28	CTC-7X2769	P-UB-10	2 X 3-1/2	73.61
CTC-7X2701	P-UB-14	3 X 6-1/4	73.49	CTC-7X2770	P-V-10	2 X 4-1/2	63.87
CTC-7X2702	P-UB-10	3 X 7-1/4	185.13	CTC-7X2773	P-UB-10	2-1/2 X 4-3/4	116.34
CTC-7X2703	P-UB-14	3-1/4 X 8-1/4	153.70	CTC-7X2783	P-UB-10	2 X 3-1/2	67.15
CTC-7X2704	P-UB-10	3-1/4 X 7	92.22	CTC-7X2784	P-UB-10	1-3/4 X 3-1/2	36.74
CTC-7X2705	P-UB-10	3-1/4 X 5-1/2	168.24	CTC-7X2785	P-UB-10	2 X 4	53.32
CTC-7X2706	P-UB-10	3-1/4 X 7-3/4	173.92	CTC-7X2787	P-UB-10	2 X 3-1/4	58.89
CTC-7X2707	P-UB-10	3-1/4 X 9-1/4	225.73	CTC-7X2788	P-UB-10	2 X 5	73.14
CTC-7X2707A	P-UB-10	3-1/4 X 9-1/4	181.48	CTC-7X2789	P-UB-10	2 X 4	66.52
CTC-7X2708	P-UB-10	3-1/4 X 9-1/4	132.90	CTC-7X2790	P-UB-10	1-3/4 X 4	60.62
CTC-7X2709	P-UB-14	3-1/4 X 5-1/2	105.34	CTC-7X2791	P-UB-10	1-3/4 X 3	57.77

REPLACEMENT KITS FOR CATERPILLAR® EQUIPMENT

NOTE: Caterpillar® kit numbers are used as a reference only. We do not imply that these kits are original REPLACEMENT KITS.

Kit Number	Code (Pg. x)	Rod X Bore Size	List Price	Kit Number	Code (Pg. x)	Rod X Bore Size	List Price
CTC-8T1551	P-UB-14	3 X 7-1/4	\$ 117.66	CTC-965606	P-UB-10	95 X 130 mm	\$ 279.84
CTC-8T1553	P-V-10	2-3/4 X 6	73.67	CTC-966457	P-UB-10	75 X 115 mm	235.21
CTC-8T1554	P-V-14	2-3/4 X 6-1/2	89.84	CTC-967799	P-UB-10	80 X 120 mm	221.94
CTC-8T1555	P-UB-14	3-1/4 X 6-1/2	115.72	CTC-995310	P-UB-14	75 X 110 mm	177.29
CTC-8T1558	P-UB-10	5-3/4 X 8-1/4	403.07	CTC-995311	P-UB-14	80 X 120 mm	189.21
CTC-8T1559	P-UB-10	3-1/2 X 8-1/4	73.25	CTC-995312	P-UB-14	65 X 100 mm	192.17
CTC-8T1565	P-UB-14	4-3/4 X 7	160.06	CTC-9S3135	SPLIT FLANGE O-RING KIT		36.25
CTC-8T1566	P-UB-14	3-1/4 X 6-1/2	115.77	CTC-9T0418	I-O-3	1 X 2	54.12
CTC-8T1567	P-UB-14	4-3/4 X 7	155.47	CTC-9T3972K	I-SP-1	9 X 10-1/2	311.23
CTC-8T1908	P-UB-14	4-3/4 X 6	142.04	CTC-9T7125	P-SP-1	1" ROD KIT	9.54
CTC-8T1909	P-UB-10	5 X 6	220.25	CTC-9T8912K	I-U-1	2-3/4 X 5-1/2	96.93
CTC-8T2066	P-UB-10	2-1/2 X 6	68.96	CTC-9X2020	I-UB-10	2-3/4 X 3-3/4	70.98
CTC-8T2166	P-UB-10	3-1/4 X 8-1/4	86.39	CTC-9X2047	P-UB-10	2-1/2 X 5-1/2	70.55
CTC-8T2216	P-UB-10	2-1/4 X 4-3/4	51.29	CTC-9X2050	P-UB-10	2-1/2 X 5-1/2	65.66
CTC-8T2583	P-UB-14	3-1/2 X 8-1/2	124.85	CTC-9X2400	P-UB-10	2-1/8 X 4	77.71
CTC-8T3574	P-UB-10	2-1/4 X 3-1/2	32.86	CTC-9X2473	P-UB-10	2-3/4 X 6-1/2	87.76
CTC-8T3575	P-UB-10	2 X 4-1/4	29.52	CTC-9X2644	P-UB-10	3-1/2 X 7-3/4	151.16
CTC-8T3576	P-UB-10	2-1/2 X 5-1/2	58.93	CTC-9X6024	P-SP-10	2-1/2 X 6-1/2	100.06
CTC-8T3589	P-UB-10	1-7/8 X 3-1/4	52.70	CTC-9X6254	P-UB-10	4-1/4 X 6-1/2	157.82
CTC-8T3591	P-UB-10	2-1/8 X 3-1/2	68.41	CTC-9X6255	P-UB-10	4-1/4 X 6-1/2	159.59
CTC-8T3593	P-UB-10	2-1/8 X 4	46.29	CTC-9X6261	P-UB-10	4 X 6	185.19
CTC-8T3648	P-UB-10	3-1/4 X 9-1/4	95.81	CTC-9X6263	P-UB-10	4 X 6	152.58
CTC-8T3740	P-UB-10	3 X 7-1/4	77.71	CTC-9X6379	P-UB-10	4-1/4 X 6-1/2	207.00
CTC-8T3852	P-UB-10	1-7/8 X 3	125.79	CTC-9X6392	P-UB-10	2-1/4 X 5	104.35
CTC-8T4770	P-UB-10	3-1/4 X 7-1/4	62.43	CTC-C75300011	P-UB-13	70 X 110 mm	144.52
CTC-8T4772	I-SP-10	4, 6-1/2 X 5-3/4	205.11	CTC-C75300021	P-UB-13	80 X 120 mm	138.20
CTC-8T4939	I-SP-10, 3	7-1/4, 10-1/2 X 9-1/4, 11-1/2	504.22	CTC-C75300031	P-UB-13	65 X 110 mm	144.99
CTC-8T4940	P-V-10	2-3/4 X 5	56.07	CTC-C95300623	P-UB-10	80 X 120 mm	180.67
CTC-8T9042	I-SP-10	5,7-1/2 X 8-1/4	296.80	CTC-C95300731	P-UB-10	65 X 100 mm	124.02
CTC-933045	P-UB-15	50 X 90 mm	188.48	CTC-C95301729	P-UB-10	75 X 110 mm	126.97
CTC-938385	P-UB-15	70 X 110 mm	138.51	CTC-E25300061	P-UB-14	90 X 140 mm	276.60
CTC-938388	P-UB-15	80 X 120 mm	225.05	CTC-E35300040	P-UB-10	85 X 125 mm	210.47
CTC-938390	P-UB-15	60 X 110 mm	220.68	CTC-E75300010	P-UB-10	100 X 140 mm	251.22
CTC-939941	P-UB-14	90 X 140 mm	199.63	CTC-E85300011	P-UB-10	85 X 120 mm	253.64
CTC-940691	P-UB-10	85 X 125 mm	210.47	CTC-E85300021	P-UB-10	95 X 130 mm	279.84
CTC-941910	P-UB-10	100 X 140 mm	251.22	CTC-E85300031	P-UB-10	75 X 115 mm	235.21
CTC-942697	P-UB-14	100 X 150 mm	166.95	CTC-F15300011	P-UB-14	100 X 150 mm	306.34
CTC-942698	P-UB-14	100 X 160 mm	254.17	CTC-F15300021	P-UB-14	110 X 160 mm	254.17
CTC-964395	P-UB-10	85 X 120 mm	253.64				



REPLACEMENT PARTS FOR CATERPILLAR® EQUIPMENT

NOTE: Caterpillar® part numbers are used as a reference only. We do not imply that these kits are original REPLACEMENT PARTS.

WIPERS

Part Number	Rod Dia.	List Price
CTC-5M6708	0.6	\$ 2.07
CTC-6J1879	3/4	3.38
CTC-5J2274	5/8	2.70
CTC-6J2274	5/8	1.75
CTC-352379	7/8	2.17
CTC-3E4124	1	5.40
CTC-6J1890	1	5.31
CTC-3E4138	1-1/8	5.95
CTC-3E4125	1-1/4	2.46
CTC-3E4139	1-1/4	6.46
CTC-3E4160	1-1/4	4.66
CTC-4J8982	1-1/4	4.28
CTC-3E4140	1-3/8	7.01
CTC-3E4159	1-3/8	7.81
CTC-3E4103	1-1/2	5.29
CTC-3E4126	1-1/2	2.83
CTC-3E4141	1-1/2	7.44
CTC-3E4161	1-1/2	5.20
CTC-4J8979	1-1/2	3.92
CTC-5J6795	1-1/2	5.37
CTC-8C9131	1-1/2	18.00
CTC-3E4104	1-5/8	5.64
CTC-4T0486	1-5/8	9.01
CTC-1506739	1-3/4	18.34
CTC-1672452	1-3/4	18.34
CTC-3E4105	1-3/4	6.02
CTC-3E4127	1-3/4	3.01
CTC-3E4142	1-3/4	8.59
CTC-3E4150	1-3/4	3.16
CTC-3E4162	1-3/4	5.81
CTC-4J8980	1-3/4	4.42
CTC-7J6932	1-3/4	9.22
CTC-7K9202	1-3/4	4.06
CTC-8C9132	1-3/4	18.34
CTC-8D6582	1-3/4	5.97
CTC-3G4721	1-7/8	2.58
CTC-3P1347	1-7/8	9.43
CTC-4T6777	1-7/8	9.28
CTC-1672457	2	19.22
CTC-1K6981	2	4.36
CTC-3E4106	2	6.82
CTC-3E4128	2	3.43
CTC-3E4143	2	11.67
CTC-3E4151	2	3.60
CTC-3E4164	2	6.52

WIPERS

Part Number	Rod Dia.	List Price
CTC-4T0415	2	\$ 8.97
CTC-5U3693	2	9.84
CTC-7K9203	2	3.85
CTC-8C9133	2	19.22
CTC-4T6125	2-1/8	7.20
CTC-3P1345	2-3/16	12.31
CTC-3E4107	2-1/4	7.58
CTC-3E4129	2-1/4	12.92
CTC-3E4144	2-1/4	12.89
CTC-3E4152	2-1/4	3.79
CTC-3E4165	2-1/4	7.28
CTC-4J3515	2-1/4	4.88
CTC-6J0217	2-1/4	9.26
CTC-7K9204	2-1/4	4.91
CTC-8C9134	2-1/4	20.02
CTC-3P1461	2-3/8	7.30
CTC-5J8016	2-3/8	16.98
CTC-6J3892	2-3/8	5.12
CTC-1K6982	2-1/2	4.82
CTC-3E4108	2-1/2	1.64
CTC-3E4130	2-1/2	3.81
CTC-3E4145	2-1/2	14.12
CTC-3E4153	2-1/2	4.00
CTC-3E4166	2-1/2	8.15
CTC-5J8156	2-1/2	14.34
CTC-7K9205	2-1/2	5.07
CTC-8C3840	2-1/2	21.57
CTC-3E4131	2-5/8	4.05
CTC-3G4719	2-5/8	3.07
CTC-7K9207	2-5/8	11.77
CTC-1672467	2-3/4	22.85
CTC-1J3540	2-3/4	6.24
CTC-3E4109	2-3/4	10.03
CTC-3E4132	2-3/4	4.35
CTC-3E4169	2-3/4	15.32
CTC-5J7036	2-3/4	10.98
CTC-7K9208	2-3/4	13.12
CTC-7U4137	2-3/4	23.06
CTC-8C3842	2-3/4	22.85
CTC-9D6588	2-3/4	13.12
CTC-2J1411	3	7.85
CTC-3E4110	3	2.02
CTC-3E4133	3	4.89
CTC-3E4146	3	16.55
CTC-3E4154	3	5.13

WIPERS

Part Number	Rod Dia.	List Price
CTC-3E4170	3	\$ 10.11
CTC-5J7030	3	11.83
CTC-5P4061	3	10.60
CTC-7K9209	3	6.30
CTC-8C5218	3	23.60
CTC-9D6589	3	9.59
CTC-5P4196	3-1/8	12.39
CTC-3E4173	3-1/4	13.05
CTC-5J7034	3-1/4	12.70
CTC-6J4169	3-1/4	9.02
CTC-7K9211	3-1/4	7.17
CTC-8T8389	3-1/4	24.27
CTC-3E4111	3-3/8	12.32
CTC-3G5052	3-3/8	10.42
CTC-5P1177	3-3/8	10.42
CTC-1433672	3-1/2	24.88
CTC-1672474	3-1/2	24.88
CTC-3E4112	3-1/2	2.43
CTC-3E4134	3-1/2	5.79
CTC-3E4147	3-1/2	18.94
CTC-3E4155	3-1/2	6.07
CTC-4J8981	3-1/2	7.66
CTC-5J7032	3-1/2	13.58
CTC-5U3529	3-1/2	18.07
CTC-7K9212	3-1/2	17.99
CTC-8C5219	3-1/2	24.88
CTC-8C5219	3-1/2	24.88
CTC-9D6591	3-1/2	9.70
CTC-3E4113	3-3/4	13.39
CTC-4T5540	3-3/4	4.37
CTC-5P2671	3-3/4	12.26
CTC-5P5322	3-3/4	21.23
CTC-7K9214	3-3/4	10.63
CTC-8C9135	3-3/4	25.30
CTC-8J6069	3-3/4	16.44
CTC-1389739	4	12.65
CTC-1672482	4	25.48
CTC-3E4114	4	15.40
CTC-3E4135	4	7.56
CTC-3E4148	4	21.37
CTC-3E4156	4	6.72
CTC-3E4177	4	23.43
CTC-5J2221	4	16.51
CTC-7J5673	4	20.48
CTC-8C5220	4	25.48

REPLACEMENT PARTS FOR CATERPILLAR® EQUIPMENT

NOTE: Caterpillar® part numbers are used as a reference only. We do not imply that these kits are original REPLACEMENT PARTS.

WIPERS

Part Number	Rod Dia.	List Price
CTC-3E4115	4-1/4	\$ 16.32
CTC-4T1637	4-1/4	5.08
CTC-5P3193	4-1/4	21.55
CTC-7J8942	4-1/4	26.28
CTC-3G5053	4-3/8	31.11
CTC-5P1176	4-3/8	30.50
CTC-3E4116	4-1/2	2.93
CTC-3E4136	4-1/2	8.80
CTC-3E4157	4-1/2	7.46
CTC-3G8505	4-1/2	14.91
CTC-3J4458	4-1/2	35.13
CTC-7K9218	4-1/2	13.74
CTC-3E4117	4-3/4	3.04
CTC-7J9256	4-3/4	16.36
CTC-0903016	5	16.85
CTC-3E4118	5	18.97
CTC-3E4137	5	9.86
CTC-3E4149	5	33.67
CTC-3E4158	5	8.82
CTC-7K9220	5	15.45
CTC-8J4520	5	29.89
CTC-9J2547	5	26.09
CTC-9X3582	5	42.94
CTC-3E4119	5-1/4	3.26
CTC-4T5663	5-1/4	36.67
CTC-6J3073	5-1/2	33.47
CTC-3E4120	5-3/4	3.52
CTC-9J5469	5-3/4	25.68
CTC-1U2708	6	50.10
CTC-3E4121	6	24.09
CTC-3J7622	6	51.72
CTC-3E4122	6-1/2	25.95
CTC-5P2322	6-1/2	52.33
CTC-6J0542	6-1/2	44.13
CTC-7J2806	6-1/2	41.16
CTC-3E4123	6-3/4	4.58
CTC-8C9146	6-3/4	52.65
CTC-2J4779	7	41.27

WIPERS

Part Number	Rod Dia.	List Price
CTC-5J2682	7	\$ 66.97
CTC-8C9136	7	53.05
CTC-9X7366	7	39.02
CTC-7J3320	7-1/2	60.81
CTC-8J9934	8-1/2	41.89
CTC-6J7694	9	61.02
CTC-1U4625	11	25.60
CTC-9X7368	11	25.60
CTC-4T4130	12-1/2	139.37
CTC-9X7369	12-1/2	131.68
CTC-6R8716	40 mm	2.73
CTC-0996995	55 mm	18.88
CTC-1163392	55 mm	8.29
CTC-1163391	60 mm	7.34
CTC-1163390	65 mm	10.30
CTC-0931434	70 mm	13.44
CTC-1163389	70 mm	9.00
CTC-1163388	75 mm	11.74
CTC-A04501419	75 mm	25.03
CTC-0931379	80 mm	15.96
CTC-1163387	80 mm	8.59
CTC-1140644	85 mm	16.46
CTC-7Y5115	85 mm	33.49
CTC-0931441	90 mm	36.21
CTC-1163386	90 mm	14.31
CTC-7X4803	90 mm	23.26
CTC-7Y4626	95 mm	13.25
CTC-0960059	100 mm	10.65
CTC-1076254	100 mm	11.78
CTC-1140646	100 mm	11.78
CTC-1140647	105 mm	26.47
CTC-1659290	105 mm	35.25
CTC-1119957	110 mm	22.84
CTC-7Y4940	110 mm	38.93
CTC-A04903618	110 mm	38.93
CTC-1119958	130 mm	30.31
CTC-1076615	140 mm	36.25
CTC-1076616	150 mm	39.53

U-SEALS

Part Number	Rod Dia.	List Price
CTC-352380	7/8	\$ 4.92
CTC-6J1889	1	5.50
CTC-5J8150	1-1/2	6.30
CTC-9J4038	1-1/2	10.04
CTC-1672300	1-3/4	5.48
CTC-5J8175	1-3/4	7.36
8.91CTC-4T6898	1-7/8	8.91
CTC-1672304	2	7.36
CTC-3G3259	2	21.84
CTC-5J8200	2	9.76
CTC-5U3644	2	5.85
CTC-9J1318	2	13.23
CTC-4T6126	2-1/8	13.60
CTC-5J8225	2-1/4	10.88
CTC-7J4820	2-1/4	14.89
CTC-0917173	2-3/8	11.17
CTC-3G2911	2-3/8	28.29
CTC-3G3260	2-3/8	9.88
CTC-5J8238	2-3/8	10.60
CTC-3G3752	2-1/2	25.65
CTC-3G3809	2-1/2	20.32
CTC-5J0964	2-1/2	10.88
CTC-7J4824	2-1/2	33.82
CTC-9X7257	2-1/2	35.16
CTC-3G4718	2-5/8	13.58
CTC-1672317	2-3/4	7.36
CTC-5J8275	2-3/4	11.10
CTC-9J2944	2-3/4	17.86
CTC-5J8300	3	12.02
CTC-5J8325	3-1/4	12.89
CTC-7J2145	3-1/4	20.67
CTC-3G5051	3-3/8	11.36
CTC-5P1140	3-3/8	8.44
CTC-1049658	3-1/2	27.06
CTC-1672324	3-1/2	9.36
CTC-5J8350	3-1/2	13.77
CTC-7J2150	3-1/2	22.26
CTC-5J8375	3-3/4	15.04
CTC-2U9113	4	19.57
CTC-5J8400	4	19.43
CTC-6J1425	4-1/4	23.25
CTC-9J1336	4-1/4	17.44
CTC-6J1450	4-1/2	22.38
CTC-9J1340	4-1/2	19.84
CTC-6J1475	4-3/4	25.71

REPLACEMENT PARTS FOR CATERPILLAR® EQUIPMENT

NOTE: Caterpillar® part numbers are used as a reference only. We do not imply that these kits are original REPLACEMENT PARTS.

U-SEALS

Part Number	Rod Dia.	List Price
CTC-9J1344	4-3/4	\$ 45.88
CTC-2U5379	5	35.54
CTC-3G5056	5	18.21
CTC-5P1139	5	18.21
CTC-6K2430	5	27.77
CTC-8J4524	5	31.78
CTC-3G2286	5-3/4	43.24
CTC-9J5467	5-3/4	39.44
CTC-9J5470	5-3/4	37.21
CTC-6J1650	6-1/2	36.91
CTC-8J1880	6-1/2	42.68
CTC-8J4387	6-1/2	48.11
CTC-6R8715	40 mm	7.37
CTC-A04600915	70 mm	12.47
CTC-A04600918	75 mm	15.16
CTC-A04600917	80 mm	16.59
CTC-7Y5117	85 mm	26.99
CTC-0961588	90 mm	15.97
CTC-7Y4629	95 mm	29.87
CTC-0962664	100 mm	16.79
CTC-1076256	100 mm	37.40
CTC-7Y4670	105 mm	32.71

NON-CATERPILLAR U-SEALS

Part Number	Rod Dia.	List Price
CTC-3E4175	1-1/8	\$ 3.78
CTC-3E4284	1-1/8	4.22
CTC-3E4181	1-1/4	3.88
CTC-3E4193	1-1/4	4.24
CTC-3E4182	1-3/8	4.09
CTC-3E4194	1-3/8	4.38
CTC-3E4183	1-1/2	4.17
CTC-3E4195	1-1/2	4.81
CTC-3E4215	1-1/2	5.83
CTC-3E4184	1-5/8	4.44
CTC-3E4216	1-3/4	6.49
CTC-3E4287	1-3/4	5.24
CTC-3E4186	2	5.23
CTC-3E4196	2	5.73
CTC-3E4217	2	6.92

NON-CATERPILLAR U-SEALS

Part Number	Rod Dia.	List Price
CTC-3E4227	2	\$ 9.77
CTC-3E4188	2-3/8	6.35
CTC-3E4187	2-1/4	5.86
CTC-3E4197	2-1/4	6.47
CTC-3E4218	2-1/4	8.20
CTC-3E4228	2-1/4	10.90
CTC-3E4189	2-1/2	6.32
CTC-3E4198	2-1/2	7.09
CTC-3E4219	2-1/2	8.26
CTC-3E4229	2-1/2	11.46
CTC-3E4199	2-3/4	7.74
CTC-3E4220	2-3/4	8.99
CTC-3E4230	2-3/4	13.09
CTC-3E4190	3	7.62
CTC-3E4200	3	8.37
CTC-3E4221	3	9.70
CTC-3E4231	3	13.62
CTC-3E4191	3-1/2	9.09
CTC-3E4202	3-1/2	9.67
CTC-3E4232	3-1/2	15.49
CTC-3E4192	3-3/4	10.64
CTC-3E4203	3-3/4	10.22
CTC-3E4225	4	12.75
CTC-3E4233	4	17.49
CTC-3E4205	4-1/4	13.32
CTC-3E4234	4-1/2	19.22
CTC-3E4235	5	21.05
CTC-3E4236	5-1/2	22.80
CTC-3E4237	6	24.38
CTC-3E4238	6-1/2	25.85
CTC-3E4240	7-1/2	32.33

ROD VEE SETS

Part Number	Rod Dia.	List Price
CTC-1J0132	1-1/4	\$ 4.44
CTC-1K7110	1-1/4	4.44
CTC-3D1123	1-1/2	14.28
CTC-1K7112	2	18.29
CTC-3F9609	2	18.07
CTC-2K4434	2-1/4	20.31
CTC-1K7114	2-1/2	22.27
CTC-4F8420	2-1/2	21.97
CTC-4J5830	2-1/2	11.79
CTC-5F3498	2-3/4	23.88
CTC-2J1408	3	15.56
CTC-2K1516	3	23.51
CTC-4J6897	3-1/4	18.56
CTC-1J2148	3-1/2	19.60
CTC-8M3912	3-1/2	9.99
CTC-2K0050	4	30.00
CTC-2K1335	4-1/2	25.63
CTC-3J7768	7-1/4	59.29

RECTANGULAR ROD SEALS

Part Number	Rod Dia.	Desc.	List Price
CTC-8C9139	2-1/2	Seal	\$ 13.84
CTC-8C9140	2-1/2	Back-Up Ring	5.83
CTC-5J1731	7	Seal	11.72
CTC-5J5150	7	Back-Up Ring	8.66
CTC-8T3539	7	Seal	8.66
CTC-8T3540	7	Back-Up Ring	13.42
CTC-6J7693	9	Seal	17.00
CTC-9J4753	9	Back-Up Ring	8.66
CTC-8T3541	9	Seal	8.66
CTC-8T3542	9	Back-Up Ring	15.89

REPLACEMENT PARTS FOR CATERPILLAR® EQUIPMENT

NOTE: Caterpillar® part numbers are used as a reference only. We do not imply that these kits are original REPLACEMENT PARTS.

1 PIECE BUFFER RINGS

Part Number	Rod Dia.	List Price
CTC-5P4673	7/8	\$ 2.88
CTC-9J3497	1-1/4	1.83
CTC-6J9733	1-1/2	3.79
CTC-6J9178	1-3/4	3.66
CTC-4T6778	1-7/8	9.09
CTC-9X3566	1-7/8	10.25
CTC-6J6917	2	4.43
CTC-4T6127	2-1/8	4.60
CTC-9X3568	2-1/8	12.72
CTC-5J3616	2-1/4	4.60
CTC-6J6916	2-3/8	4.90
CTC-5J3620	2-1/2	5.02
CTC-6J6553	2-3/4	5.33
CTC-1U4020	2-5/8	5.83
CTC-9T9363	2-5/8	15.37
CTC-6J6915	3	5.60
CTC-6J7167	3-1/4	6.02
CTC-6J6736	3-1/2	7.61
CTC-8J6070	3-3/4	8.15
CTC-8J4627	4	13.11
CTC-7J8943	4-1/4	6.92
CTC-3G5055	4-3/8	6.20
CTC-7J9257	4-3/4	10.68
CTC-8J4509	5	11.62
CTC-9J5468	5-3/4	13.36
CTC-6J8631	6-1/2	14.29
CTC-9J2495	7	14.83
CTC-A04600811	65 mm	7.35
CTC-7Y4630	95 mm	34.63

2 PIECE BUFFER RINGS

Part Number	Rod Dia.	List Price
CTC-8C9122	1-1/2	\$ 8.98
CTC-1672190	1-3/4	9.57
CTC-8C9123	1-3/4	9.57
CTC-1672195	2	12.75
CTC-8C9124	2	10.47
CTC-8C9125	2-1/4	13.50
CTC-8C9138	2-3/8	15.03
CTC-8C3839	2-1/2	12.49
CTC-1672207	2-3/4	15.92
CTC-8C3841	2-3/4	15.92
CTC-8C9126	3	14.87
CTC-8C9121	3-1/4	15.86
CTC-1672211	3-1/2	19.19
CTC-8C9127	3-1/2	19.19
CTC-8C9128	3-3/4	20.34
CTC-1672216	4	21.44
CTC-8C9129	4	21.44
CTC-6E0425	4-1/4	36.04
CTC-9X7261	4-3/4	37.50
CTC-9X3581	5	38.10
CTC-9X7267	5-1/4	39.28
CTC-9X3575	5-3/4	42.10
CTC-8C9130	7	53.53
CTC-0931481	60 mm	17.34
CTC-0931482	65 mm	20.61
CTC-A04601014	65 mm	20.61
CTC-0931483	70 mm	22.49
CTC-A04601015	70 mm	22.49
CTC-0963469	75 mm	23.91
CTC-A04601016	75 mm	23.91
CTC-0931484	80 mm	25.32
CTC-A04601017	80 mm	25.32
CTC-7Y5118	85 mm	27.18
CTC-0961585	90 mm	32.80
CTC-7Y4630	95 mm	34.63
CTC-0962663	100 mm	35.63
CTC-1231942	105 mm	36.92
CTC-7Y4943	110 mm	38.43
CTC-A04601018	110 mm	38.43

2 PIECE PISTON SEALS

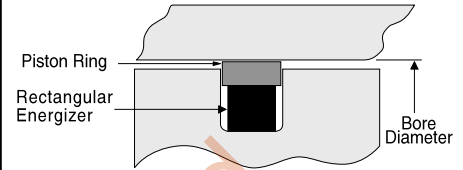

Part Number	Bore Dia.	List Price
CTC-5J7004A	2	\$ 6.73
CTC-1U3998A	2-1/4	8.40
CTC-8J6213A	2-1/2	8.01
CTC-5J7010A	2-3/4	12.24
CTC-6J1972A	3	9.00
CTC-6J0793A	3-1/4	12.78
CTC-5J7013A	3-1/2	11.20
CTC-5J8011A	3-3/4	16.27
CTC-5J5402A	4	12.65
CTC-5J7854A	4-1/4	13.68
CTC-5J4986A	4-1/2	15.80
CTC-5J4987A	4-3/4	17.26
CTC-5J5020A	5	18.70
CTC-5J7234A	5-1/4	22.29
CTC-5J4988A	5-1/2	22.10
CTC-9J4981A	5-3/4	30.58
CTC-5J4989A	6	21.13
CTC-5J4990A	6-1/4	21.59
CTC-5J4991A	6-1/2	24.26
CTC-5J4997A	7	26.30
CTC-5J4993A	7-1/4	23.61
CTC-9J7117A	7-1/2	48.29
CTC-5J7016A	7-3/4	61.66
CTC-5J5559A	8-1/4	29.87
CTC-6J9385A	8-1/2	33.17
CTC-5J7019A	9-1/4	37.31
CTC-1200890	75 mm	12.90

REPLACEMENT PARTS FOR CATERPILLAR® EQUIPMENT

NOTE: Caterpillar® part numbers are used as a reference only. We do not imply that these kits are original REPLACEMENT PARTS.

2 PIECE STEP-CUT PISTON SEALS

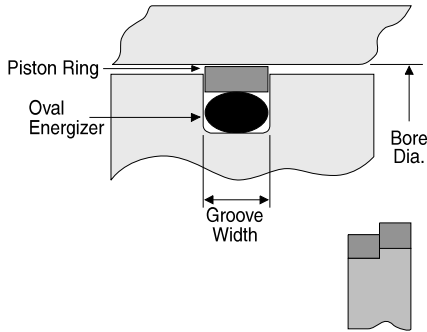

Part Number	Bore Dia.	Groove Width	List Price
CTC-4T8054	3-1/2	0.19	\$ 24.69
CTC-8C9160	4	0.25	28.67
CTC-9X7269	4-1/2	0.25	43.39
CTC-9X7264	5	0.38	34.93
CTC-8T0763	5-1/4	0.38	28.50
CTC-6E0465	5-1/2	0.38	43.67
CTC-4T5173	5-1/2	0.63	26.75
CTC-4T4144	6	0.63	29.64
CTC-4T8695	6-1/2	0.63	30.95
CTC-8T1789	7	0.63	25.58
CTC-8T1792	7-3/4	0.63	30.43
CTC-9T0119	8-1/2	0.63	46.64
CTC-8T1793	8-1/4	0.63	46.03
CTC-8T1794	10	0.69	74.67
CTC-8T1796	10-1/2	0.69	77.92
CTC-8T1797	11-1/2	0.69	98.23
CTC-9X7298	100 mm	7.24 mm	59.54
CTC-9X7301	110 mm	7.24 mm	70.67
CTC-9X3592	120 mm	7.24 mm	70.67
CTC-9X3595	130 mm	7.24 mm	70.67
CTC-9X3598	140 mm	9.63 mm	64.36
CTC-9X3601	150 mm	9.63 mm	63.95
CTC-9X3604	160 mm	9.63 mm	63.95
CTC-9X3607	170 mm	9.63 mm	68.86
CTC-9X3610	180 mm	9.63 mm	68.84

5 PIECE PISTON SEALS

Part Number	Bore Dia.	List Price
CTC-931488	90 mm	\$ 74.47
CTC-A04601215	110 mm	89.04
CTC-A04601216	120 mm	89.04

CAPPED PISTON T-SEALS

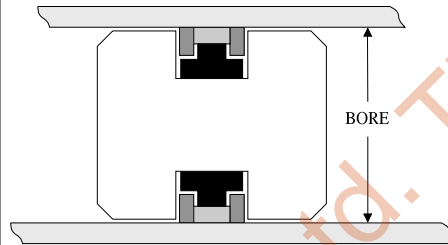

Part Number	Bore Dia.	List Price
CTC-8J3747	4-1/2	\$ 50.33
CTC-9J7868	5	61.50
CTC-8J8767	5-1/2	69.01
CTC-9J1242	6	72.10
CTC-9J5558	6-1/4	73.65
CTC-8J8703	6-1/2	81.25
CTC-8J3749	7	83.78
CTC-8J4510	7-1/4	86.51
CTC-9J5567	7-1/2	87.73
CTC-8J5644	7-3/4	91.40
CTC-8J4390	8-1/4	97.50
CTC-3G4762	8-1/2	102.26
CTC-9J3406	10	121.32
CTC-3G4765	10-1/2	131.03
CTC-9J2987	11-1/2	149.14
CTC-0996998	80 mm	30.44
CTC-0996973	90 mm	34.98
CTC-5I5928	100 mm	37.78
CTC-0996922	110 mm	39.43
CTC-A04601713	110 mm	39.43
CTC-A04601719	160 mm	69.07

NON CATERPILLAR PISTON SEALS

Part Number	Bore Dia.	List Price
CTC-3E4244	1	\$ 2.43
CTC-3E4245	1-1/8	3.26
CTC-3E4246	1-1/4	2.69
CTC-3E4247	1-1/2	2.81
CTC-3E4248	1-5/8	2.85
CTC-3E4249	1-3/4	2.93
CTC-3E4250	2	3.03
CTC-3E4251	2-1/4	3.15
CTC-3E4252	2-1/2	3.19
CTC-3E4253	2-3/4	3.23
CTC-3E4254	3	3.31
CTC-3E4255	3-1/4	3.37
CTC-3E4256	3-1/2	3.46

OVERSIZED HEAD SEALS

Part Number	Bore Dia.	List Price
CTC-8T8373	4-3/4	\$ 8.55
CTC-8T8374	5	26.62
CTC-8T8376	5-1/2	34.45
CTC-8T8377	6	34.15
CTC-8T8379	6-1/2	35.16
CTC-8T8380	7	36.27
CTC-8T8381	7-1/4	17.46
CTC-8C4892	7-3/4	22.85
CTC-8T8382	8-1/4	14.36

REPLACEMENT PARTS FOR CATERPILLAR® EQUIPMENT

NOTE: Caterpillar® part numbers are used as a reference only. We do not imply that these kits are original REPLACEMENT PARTS.

WEAR RINGS

Part Number	O.D. X Width	List Price
CTC-4T6780	1-5/8 X .98	\$ 7.91
CTC-8T5443	1-5/8 X 1-1/4	11.99
CTC-4T6907	1-7/8 X .98	35.63
CTC-8T6442	2 X .72	14.24
CTC-4T6779	2 X .98	12.13
CTC-8T6441	2 X 1/4	12.55
CTC-4T5613	2-1/8 X 1	8.26
CTC-8T7030	2-1/8 X 1-1/4	17.91
CTC-8T6682	2-1/4 X .36	29.71
CTC-8T6681	2-1/4 X .72	29.28
CTC-7H2423	2-1/4 X 7/8	4.59
CTC-4T6128	2-1/4 X .98	16.39
CTC-8T4958	2-3/8 X 1	21.10
CTC-8T8204	2-3/8 X 1-3/16	18.86
CTC-9X7260	2-1/2 X 1.246	10.31
CTC-8J6212	2-1/2 X 3/4	5.55
CTC-009004097	2.51 X 3.11	24.38
CTC-8T0785	2-5/8 X .98	20.49
CTC-8T5668	2-5/8 X 1-1/4	12.59
CTC-8T8394	2-5/8 X 1-11/16	29.97
CTC-8T8365	2.7 X 2.28	44.56
CTC-8T7372	2-3/4 X .97	8.50
CTC-8J0112	2-3/4 X 15/16	8.64
CTC-8C9114	2-7/8 X 1	25.40
CTC-8C9200	2-7/8 X 1	25.40
CTC-8T7849	2-7/8 X 1.57	29.68
CTC-6C2385	2-7/8 X 1-1/4	27.09
CTC-8T7020	2-7/8 X 1-13/16	19.29
CTC-8T6743	2.95 X 1.96	37.43
CTC-6J5733	3 X .99	9.89
CTC-8T6443	3 X 1	9.03
CTC-4T7283	3 X 1.24	24.51
CTC-8C9161	3-1/8 X .97	13.44
CTC-9T0094	3-1/8 X 1.24	42.24
CTC-8T7584	3-1/8 X 1-5/8	23.90
CTC-8T1714	3-1/8 X 1-9/16	46.82
CTC-8C9153	3.20 X 1.17	10.59
CTC-8J6371	3-1/4 X 1.11	11.48
CTC-8T6683	3-1/4 X 1-1/8	34.27
CTC-8J2577	3-1/4 X 3/4	2.99

WEAR RINGS

Part Number	O.D. X Width	List Price
CTC-8T6745	3.45 X 1.96	\$ 19.65
CTC-8T4813	3.45 X 1-5/8	30.71
CTC-8T6744	3.45 X 2.74	26.68
CTC-8T0777	3-3/8 X 1.74	42.57
CTC-4J3236	3-1/2 X 1-1/2	10.68
CTC-7J9885	3-1/2 X 1-1/8	9.38
CTC-6H5496	3-1/2 X 7/8	6.22
CTC-8C5245	3-5/8 X 1.05	28.73
CTC-8T3329	3-5/8 X 1.88	34.45
CTC-8C3829	3.7 X 1.76	56.18
CTC-1324907	3.7 X 1.88	50.47
CTC-8T6746	3.7 X 2.36	19.16
CTC-8J6245	3-3/4 X 1	11.33
CTC-5J8019	3-3/4 X 1.24	9.41
CTC-6J3075	3-3/4 X 1.99	24.85
CTC-8T7848	3-7/8 X 1.57	47.13
CTC-8T3330	3.95 X 2-7/16	25.24
CTC-6J2797	4 X .99	9.30
CTC-6U3246	4 X 1	3.60
CTC-5J7154	4 X 5/8	3.22
CTC-8H0214	4 X 7/8	6.35
CTC-1M1571	4X1-1/4	10.41
CTC-3G4723	4-1/8 X .42	10.85
CTC-8T7538	4.2 X 1.56	21.34
CTC-8T6747	4.2 X 2.55	40.24
CTC-1194760	4-1/4 X 1	8.01
CTC-6J7264	4-1/4 X 1	4.32
CTC-5J8157	4-1/4 X 1.49	11.74
CTC-4T4753	4-1/4 X 1.88	16.67
CTC-6J4003	4-1/4 X 1-1/4	8.80
CTC-7J3300	4.258 X 2.49	32.27
CTC-8T6748	4.45 X 2-3/8	44.94
CTC-4J3745	4-1/2 X 1	10.25
CTC-6U4154	4-1/2 X 1	4.41
CTC-4T8758	4-1/2 X 1.86	21.96
CTC-6J4175	4-1/2 X 1.86	21.96
CTC-4J2620	4-1/2 X 1-1/2	13.53
CTC-4J2630	4-1/2 X 1-1/2	13.53
CTC-4J4605	4-1/2 X 15/16	9.79
CTC-0901301	4-1/2 X 2.362	36.57

WEAR RINGS

Part Number	O.D. X Width	List Price
CTC-5U3531	4-1/2 X 3/4	\$ 3.21
CTC-6H6270	4-1/2 X 7/8	7.45
CTC-3J7663	4-3/4 X 1.99	39.34
CTC-4J3342	4-3/4 X 1-1/4	12.90
CTC-4T9248	4-3/4 X 1-1/4	12.90
CTC-4T6929	4-3/4 X 3-1/2	37.77
CTC-9J9792	4-3/4 X 3-1/2	37.77
CTC-8T7850	4.950 X 1.96	56.71
CTC-8M4226	5 X 1.24	23.38
CTC-4J3420	5 X 1.55	13.52
CTC-4J4630	5 X 1-1/8	12.02
CTC-4T4752	5 X 1-3/4	59.18
CTC-8T3331	5.2 X 2-1/2	56.18
CTC-2D0714	5-1/4 X 1.02	24.84
CTC-9J7978	5-1/4 X 1.49	16.63
CTC-9J3054	5-1/4 X 3.61	76.59
CTC-9J9798	5-1/4 X 3/4	3.30
CTC-4T5718	5.45 X 2.49	58.89
CTC-7J3303	5-1/2 X 1.61	30.27
CTC-9J7191	5-1/2 X 1.74	38.10
CTC-4J3518	5-1/2 X 1.99	33.39
CTC-8C9112	5-1/2 X 1.99	33.39
CTC-4J4606	5-1/2 X 1-1/4	13.49
CTC-7J1731	5-1/2 X 1-3/4	16.63
CTC-3J9026	5-1/2 X 1-3/8	23.79
CTC-8J1690	5-1/2 X 2.24	39.20
CTC-5U4278	5-1/2 X 3/4	3.36
CTC-9J4164	5-3/4 X 1.62	49.70
CTC-6J3074	5-3/4 X 1.99	28.90
CTC-8J9917	5-3/4 X 2.36	52.17
CTC-8T7851	5.95 X 1.96	56.14
CTC-8T3332	5.95 X 3.61	85.07
CTC-3G6537	6 X 1.07	17.66
CTC-9J5860	6 X 1-1/2	20.61
CTC-5J0014	6 X 1-1/4	17.23
CTC-7J5326	6 X 1-3/4	31.05
CTC-1J0708	6 X 1-5/16	17.85
CTC-4T6930	6 X 2.74	57.16
CTC-8J1746	6 X 2.74	88.08
CTC-8J1764	6 X 2.74	88.08

REPLACEMENT PARTS FOR CATERPILLAR® EQUIPMENT

NOTE: Caterpillar® part numbers are used as a reference only. We do not imply that these kits are original REPLACEMENT PARTS.

WEAR RINGS

Part Number	O.D. X Width	List Price
CTC-8J1714	6 X 2.86	\$ 65.08
CTC-5J3326	6-1/4 X 1.49	19.90
CTC-9J5550	6-1/4 X 1-3/4	31.46
CTC-4T9319	6-1/4 X 2.74	87.91
CTC-3J9027	6-1/2 X 1.37	17.14
CTC-9J9806	6-1/2 X 1.74	31.32
CTC-3J9703	6-1/2 X 1-1/2	16.03
CTC-9T0096	6-1/2 X 1-1/2	16.03
CTC-5J0058	6-1/2 X 1-1/4	17.62
CTC-7J1938	6-1/2 X 2	29.78
CTC-9J3055	6-1/2 X 2.74	67.45
CTC-7J9232	6-1/2 X 2.86	43.13
CTC-9J0811	6-1/2 X 3.485	85.86
CTC-7J8881	6-1/2 X 3.49	116.87
CTC-3G5098	7 X 1.74	31.40
CTC-9J0711	7 X 1.99	26.57
CTC-3G3470	7 X 2.365	79.80
CTC-8J1662	7 X 3-1/8	55.06
CTC-8T6749	7.2 X 3.14	76.06
CTC-1J2674	7-1/4 X 1-3/8	21.13
CTC-3J7848	7-1/4 X 2	34.53
CTC-1U1734	7-1/4 X 3-1/16	96.39
CTC-4J7663	7-1/4 X 7.10	161.53
CTC-8T1127	7-3/8 X 1.61	64.66
CTC-8J9936	7-1/2 X 2.36	50.15
CTC-4T4811	7-1/2 X 2.95	127.22
CTC-9J5562	7-1/2 X 2-1/2	48.88
CTC-9J5037	7-3/4 X 1.61	74.14
CTC-9J3624	7-3/4 X 1.99	36.41
CTC-7J9247	7-3/4 X 3-1/2	82.58
CTC-3G4625	7-3/4 X 4.49	167.36
CTC-4T6932	7-3/4 X 4.49	167.36
CTC-4J9047	8 X 5	77.45
CTC-4J7376	8-1/4 X 1-1/2	24.16
CTC-2J0745	8-1/4 X 1-1/4	17.91
CTC-3J8683	8-1/4 X 1-3/4	27.25
CTC-3G9882	8-1/4 X 1.99	79.27
CTC-8J8375	8-1/4 X 2-1/8	48.23
CTC-3J7632	8-1/4 X 2-1/4	29.00
CTC-7J3301	8-1/4 X 2.49	79.26

WEAR RINGS

Part Number	O.D. X Width	List Price
CTC-8J8826	8-1/4 X 2.74	\$ 63.93
CTC-9J8102	8-1/4 X 2.74	109.33
CTC-4T9320	8-1/4 X 3-1/2	110.11
CTC-9J3056	8-1/4 X 4.11	136.98
CTC-7J8064	8-1/2 X 2.36	69.75
CTC-9M1604	8-1/2 X 3	78.83
CTC-1J5281	9-1/4 X 1-3/4	29.47
CTC-7J2087	9-1/4 X 2-1/4	79.33
CTC-4T6097	9-1/2 X 1.93	110.57
CTC-9J3369	10 X 3-1/4	63.00
CTC-9J2991	11-1/2 X 3-7/8	69.40
CTC-4T6096	12-1/4 X 4	216.80
CTC-8T1130	12-7/8 X 2.86	233.59
CTC-4T4827	12-7/8 X 12.18	1015.51
CTC-4T4129	14-1/4 X 3.99	247.19
CTC-9J1159	10-1/2 X 2.74	106.88
CTC-8J8900	10-1/2 X 3-3/4	63.25
CTC-8J5980	10-1/2 X 4	94.88
CTC-4T4825	15-1/8 X 7.71	760.09
CTC-0908007	55 X 7.9 mm	12.00
CTC-1057252	71.3 X 5.9 mm	21.42
CTC-1052630	81.3 X 5.9 mm	16.13
CTC-1057388	91.3 X 5.9 mm	6.18
CTC-1079306	105X15 mm	15.03
CTC-A04901911	110 X 30 mm	15.90
CTC-7Y4636	130 X 40 mm	38.99
CTC-1076264	140 X 8 mm	19.14
CTC-1076263	140 X 9.5 mm	10.25
CTC-1163589	150 X 45 mm	42.40
CTC-0961581	150 X 7.9 mm	40.40

SELF-ALIGNING BALL BUSHINGS

Part Number	Rod Dia.	List Price
CTC-9M3914	3/4	\$ 18.23
CTC-4D0298	1-1/2	37.69
CTC-4D4431	1-3/4	51.43
CTC-9M1328	2	61.22
CTC-7J1309	2-1/2	118.72
CTC-5J6424	3	189.49

SILICONE O-RINGS

Part Number	Min. Pkgs.	List Price
CTC-1M6036	2	\$ 4.06
CTC-1S0004	5	2.30
CTC-1S2174	5	1.76
CTC-1S7462	6	.61
CTC-1S9799	6	1.19
CTC-2M2561	3	3.34
CTC-2P3538	5	2.70
CTC-2S2251	5	3.95
CTC-5H7153	4	2.08
CTC-5H8853	20	.24
CTC-5M3038	5	2.27
CTC-6F0249	4	.88
CTC-6L1648	4	2.52
CTC-6L1649	3	2.89
CTC-6L1650	3	2.70
CTC-6L1651	3	4.24
CTC-6L9284	3	2.80
CTC-8M1112	6	.72
CTC-8M4389	5	.71
CTC-8M4390	3	2.70
CTC-8M4395	3	1.84
CTC-8M4431	4	.64
CTC-8M4432	5	1.41
CTC-8M4435	5	1.06
CTC-8M4436	3	2.48

REPLACEMENT PARTS FOR CATERPILLAR® EQUIPMENT

NOTE: Caterpillar® part numbers are used as a reference only. We do not imply that these kits are original REPLACEMENT PARTS.

SILICONE O-RINGS

Part Number	Min. Pkgs.	List Price
CTC-8M4437	10	\$.59
CTC-8M4438	5	.61
CTC-8M4443	3	2.23
CTC-8M4445	5	1.17
CTC-8M4446	5	1.25
CTC-8M4447	6	.58
CTC-8M4448	5	.63
CTC-8M4986	10	2.05
CTC-8M4987	10	1.77
CTC-8M4988	5	1.39
CTC-8M4989	2	3.07
CTC-8M4990	3	2.05
CTC-8M4991	3	3.21
CTC-8M4992	3	2.19
CTC-8M5010	3	2.60
CTC-8M5248	5	1.53
CTC-8M5249	5	1.88
CTC-8M5252	3	3.12
CTC-8M5253	8	.39
CTC-8M5254	5	1.64
CTC-8M5260	8	.37
CTC-8M5661	3	2.34
CTC-8M8157	5	.54
CTC-8M8281	5	.84
CTC-8M8282	6	.60
CTC-8M8283	3	.78
CTC-8M8515	5	1.23
CTC-9H6067	5	2.48
CTC-9M4218	2	3.16
CTC-9M4849	5	2.63
CTC-9M7002	3	3.65
CTC-9M7539	3	2.17
CTC-9M9647	3	3.81

O-RINGS

Part Number	Min. Pkgs.	List Price
CTC-0032770	2	\$ 2.92
CTC-0068352	10	5.41
CTC-0314392	4	.67
CTC-0951625	2	1.65
CTC-0951626	2	1.70
CTC-0951627	2	1.70
CTC-0951631	2	2.44
CTC-0951632	2	2.57
CTC-0951633	2	3.74
CTC-0951635	2	3.07
CTC-0951671	5	1.38
CTC-0951673	5	1.55
CTC-0951674	5	1.87
CTC-0951675	5	1.78
CTC-0951676	5	1.84
CTC-0951710	5	1.04
CTC-0951713	5	1.38
CTC-0951716	5	1.87
CTC-0951717	5	1.78
CTC-0951718	5	1.84
CTC-0951719	5	1.87
CTC-0951721	2	1.95
CTC-1757896	10	.21
CTC-1H5728	10	.36
CTC-1H6227	10	.68
CTC-1H7339	10	.45
CTC-1H8128	10	.58
CTC-1H8171	20	.18
CTC-1H8278	2	2.02
CTC-1H9696	20	.24
CTC-1J2176	2	2.02
CTC-1J2859	4	.88
CTC-1J9671	25	.35
CTC-1M9015	2	2.98
CTC-1S7408	4	1.04
CTC-1T0132	2	2.97
CTC-1U3174	2	2.59
CTC-2D0598	20	.24
CTC-2D6533	1	5.62
CTC-2D8009	4	1.26

O-RINGS

Part Number	Min. Pkgs.	List Price
CTC-2D8363	1	\$ 10.67
CTC-2H2665	10	.52
CTC-2H3927	10	.34
CTC-2H3928	10	.68
CTC-2H3931	10	.45
CTC-2H3932	20	.20
CTC-2H3933	10	.52
CTC-2H3934	10	.58
CTC-2H3935	4	1.12
CTC-2H4145	10	.54
CTC-2H6184	10	1.37
CTC-2H6338	10	.54
CTC-2H6340	1	4.72
CTC-2H9247	4	1.12
CTC-2K2939	2	1.57
CTC-2K4472	2	2.01
CTC-2K8257	2	1.57
CTC-2M0340	2	2.47
CTC-2M1309	1	4.72
CTC-2M4453	50	.06
CTC-2M9780	20	.24
CTC-2S4078	10	.50
CTC-2S8439	4	1.10
CTC-2U5341	5	.98
CTC-2U5343	5	3.15
CTC-304606	8	.65
CTC-3D2824	19	.27
CTC-3D2898	20	.24
CTC-3D2992	50	.08
CTC-3D4245	20	.07
CTC-3D8241	1	12.92
CTC-3E6703	5	1.00
CTC-3F5792	4	1.12
CTC-3H0107	20	.18
CTC-3H2652	10	.45
CTC-3H3385	50	.06
CTC-3J0634	2	2.00
CTC-3J1907	25	.20
CTC-3J7354	29	.18
CTC-3K0360	25	.38

REPLACEMENT PARTS FOR CATERPILLAR® EQUIPMENT

NOTE: Caterpillar® part numbers are used as a reference only. We do not imply that these kits are original REPLACEMENT PARTS.

O-RINGS

Part Number	Min. Pkgs.	List Price
CTC-3P0651	1	\$ 6.17
CTC-3S1223	4	1.51
CTC-3S6538	10	.34
CTC-4D1577	1	6.12
CTC-4D3107	20	.18
CTC-4D4508	1	7.30
CTC-4D6695	1	5.84
CTC-4F5607	10	.34
CTC-4F7387	4	.88
CTC-4F7389	10	.34
CTC-4F7390	10	.45
CTC-4F7391	20	.20
CTC-4F7952	20	.24
CTC-4F8824	10	.34
CTC-4F8946	20	.18
CTC-4F9029	20	.20
CTC-4F9653	10	.34
CTC-4H6520	2	2.00
CTC-4H6730	1	9.50
CTC-4H9105	4	.90
CTC-4J0519	19	.27
CTC-4J0520	19	.82
CTC-4J0521	19	.27
CTC-4J0522	19	.87
CTC-4J0523	17	.30
CTC-4J0524	17	.30
CTC-4J0525	15	.36
CTC-4J0526	15	.36
CTC-4J0527	15	.36
CTC-4J0528	15	.38
CTC-4J1253	1	8.43
CTC-4J5140	25	.20
CTC-4J5267	23	.22
CTC-4J5268	29	.18
CTC-4J5351	27	.18
CTC-4J5477	34	.16
CTC-4J5573	17	.30
CTC-4J7533	29	.18
CTC-4J8996	25	.20
CTC-4J8997	23	.73

O-RINGS

Part Number	Min. Pkgs.	List Price
CTC-4K1388	12	\$.42
CTC-4K6804	2	2.47
CTC-4L9564	10	.68
CTC-4M0189	10	.68
CTC-4M0661	1	7.30
CTC-4M0737	1	7.30
CTC-4S5879	1	5.84
CTC-4S7762	2	2.36
CTC-4T4128	1	5.80
CTC-5F0149	4	.74
CTC-5F1678	20	.18
CTC-5F3092	10	.63
CTC-5F3106	4	1.12
CTC-5F3144	4	.90
CTC-5F3999	4	1.12
CTC-5F7054	20	.18
CTC-5F8000	20	.27
CTC-5F9657	20	.24
CTC-5H3252	4	1.26
CTC-5H4909	2	3.11
CTC-5H5672	4	1.04
CTC-5H6733	4	1.14
CTC-5H6734	4	.90
CTC-5H7370	10	.34
CTC-5H8624	4	.74
CTC-5H8848	10	.36
CTC-5H9524	4	1.62
CTC-5J2974	29	.18
CTC-5K1787	2	2.76
CTC-5K5959	10	.36
CTC-5K9090	25	.21
CTC-5L5032	2	1.91
CTC-5M5860	10	.34
CTC-5M6200	1	5.80
CTC-5P1979	4	1.35
CTC-5P2235	2	2.93
CTC-5P2236	1	5.12
CTC-5P2568	20	.24
CTC-5P4326	4	1.04
CTC-5P5756	3	4.80

O-RINGS

Part Number	Min. Pkgs.	List Price
CTC-5P6302	7	\$.58
CTC-5P7593	3	1.64
CTC-5S3676	2	3.11
CTC-6D9157	4	1.51
CTC-6F0711	20	.24
CTC-6F4718	2	1.57
CTC-6F4855	50	.08
CTC-6F6673	20	.27
CTC-6F8146	10	.45
CTC-6H3977	10	.45
CTC-6J1038	29	.63
CTC-6J2419	20	.18
CTC-6J5541	4	1.37
CTC-6K6307	10	.54
CTC-6K9149	2	3.13
CTC-6V1934	1	5.53
CTC-6V3263	1	8.34
CTC-6V8397	34	.38
CTC-6V8398	34	.49
CTC-6V8400	20	.68
CTC-6V9746	25	.20
CTC-7D1195	3	2.09
CTC-7F2122	10	.54
CTC-7F8267	20	.27
CTC-7H2444	10	.63
CTC-7J0204	29	.18
CTC-7J8956	4	1.62
CTC-7J9108	29	.18
CTC-7M8485	12	.42
CTC-7S8554	1	4.74
CTC-8B4967	20	.27
CTC-8F4469	4	1.51
CTC-8F4994	20	.27
CTC-8F5900	2	2.81
CTC-8F6230	2	2.81
CTC-8F6711	20	.32
CTC-8F8230	2	2.81
CTC-8F8733	2	1.57
CTC-8F8861	1	4.49
CTC-8F8882	10	.36

REPLACEMENT PARTS FOR CATERPILLAR® EQUIPMENT

NOTE: Caterpillar® part numbers are used as a reference only. We do not imply that these kits are original REPLACEMENT PARTS.

O-RINGS

Part Number	Min. Pkgs.	List Price
CTC-8F9206	50	\$.18
CTC-8F9516	4	1.26
CTC-8F9960	1	8.43
CTC-8H0273	2	1.91
CTC-8H2046	10	.68
CTC-8H7521	10	.58
CTC-8J1665	4	1.62
CTC-8J1688	4	1.35
CTC-8J4386	2	3.66
CTC-8J8879	2	3.59
CTC-8L9241	2	3.05
CTC-8M8997	50	.08
CTC-8P6357	1	10.60
CTC-8T0315	20	.24
CTC-8T2360	3	1.59
CTC-8T2361	3	1.61
CTC-8T6404	2	2.36
CTC-9F1399	2	1.57
CTC-9F4446	10	.63
CTC-9F7283	4	.88
CTC-9H0846	1	11.88
CTC-9H4557	20	.22
CTC-9J5686	8	.64
CTC-9M2092	4	.88
CTC-9M3786	4	1.35
CTC-9M5024	2	2.47
CTC-9M5894	2	2.25
CTC-9S3888	4	1.30
CTC-9X4611	7	.75
CTC-Z440101000	2	1.70
CTC-Z440101100	2	2.06
CTC-Z440201000	2	1.89
CTC-Z440201400	2	3.74
CTC-Z441001100	5	1.87
CTC-Z441101050	5	1.78
CTC-Z441101150	5	1.93
CTC-Z441101600	2	4.20

BACK-UP RINGS

Part Number	Min. Pkgs.	List Price
CTC-0875391	1	\$ 7.08
CTC-0875436	1	5.19
CTC-0875510	1	5.00
CTC-0875550	1	6.69
CTC-0961587	1	7.75
CTC-0962665	1	9.03
CTC-0990660	1	6.59
CTC-0990699	1	6.47
CTC-0995399	1	4.66
CTC-0997000	1	4.61
CTC-1057360	1	4.89
CTC-1057375	1	5.00
CTC-1057393	1	6.42
CTC-1076255	1	9.03
CTC-1076258	1	21.97
CTC-1220440	1	9.02
CTC-1400233	3	2.36
CTC-1K7095	4	1.58
CTC-1K7098	5	1.29
CTC-1S0668	6	.89
CTC-1S0669	5	1.94
CTC-1S0670	8	.67
CTC-1U1101	2	4.73
CTC-1U1626	1	5.01
CTC-1U1738	2	3.16
CTC-1U1770	2	3.55
CTC-1U3173	2	3.42
CTC-1U3307	2	3.55
CTC-1U3383	1	20.35
CTC-2J0744	2	4.66
CTC-2J3961	3	1.80
CTC-2J4066	5	1.04
CTC-2J7767	3	2.08
CTC-2K2940	2	3.41
CTC-2K2961	3	2.36
CTC-2K3258	2	2.82
CTC-2K4096	3	2.00
CTC-2K4473	2	3.07
CTC-2K6830	5	1.29
CTC-2K8256	2	2.32

BACK-UP RINGS

Part Number	Min. Pkgs.	List Price
CTC-2Y8973	6	\$.87
CTC-3C3239	10	.72
CTC-3G3747	2	4.23
CTC-3J2688	1	5.11
CTC-3J8466	1	4.99
CTC-3J9742	2	3.81
CTC-3K7219	9	.63
CTC-3K7863	9	.59
CTC-3K8692	9	.63
CTC-3K8699	10	.65
CTC-3P1204	8	.67
CTC-3P1205	8	.63
CTC-3P1206	5	1.19
CTC-3P1207	7	.82
CTC-4I3627	1	5.34
CTC-4I6330	1	7.81
CTC-4J1151	1	5.24
CTC-4J6557	2	4.73
CTC-4J9218	2	3.35
CTC-4J9219	5	.87
CTC-4J9220	5	1.29
CTC-4J9221	4	1.47
CTC-4J9223	2	3.07
CTC-4J9224	6	.89
CTC-4J9225	7	.82
CTC-4K4759	9	.59
CTC-4T3107	2	3.56
CTC-5J0604	2	2.70
CTC-5J0605	10	.72
CTC-5J3934	5	1.06
CTC-5J6444	2	3.51
CTC-5J7865	5	1.29
CTC-5K7865	5	1.29
CTC-5P0909	3	2.36
CTC-5P0909	3	2.36
CTC-5P0910	4	1.63
CTC-5P0911	6	.99
CTC-5P0911	6	.99
CTC-5P2134	8	.72
CTC-5P2199	10	.65

REPLACEMENT PARTS FOR CATERPILLAR® EQUIPMENT

NOTE: Caterpillar® part numbers are used as a reference only. We do not imply that these kits are original REPLACEMENT PARTS.

BACK-UP RINGS

Part Number	Min. Pkgs.	List Price
CTC-5P3235	2	\$ 3.56
CTC-5P7857	9	.59
CTC-5P7858	9	.59
CTC-5P8208	10	.65
CTC-5P8921	4	1.74
CTC-5P9685	8	.65
CTC-5P9686	8	.72
CTC-5P9687	8	.72
CTC-6J1021	10	.72
CTC-6J1381	6	.89
CTC-6J2418	8	.72
CTC-6J2420	7	.82
CTC-6J5731	7	.82
CTC-6U3042	3	2.52
CTC-6U5640	3	1.30
CTC-6V1555	7	.82
CTC-6V1556	8	.67
CTC-6V1557	10	.65
CTC-6V1558	7	.82
CTC-6V1941	8	.63
CTC-6V3299	8	.72
CTC-6V3300	8	.72
CTC-6V3580	1	9.02
CTC-6V3838	9	.59
CTC-6V3956	9	.59
CTC-7J6287	10	.72
CTC-7J6288	8	.65

BACK-UP RINGS

Part Number	Min. Pkgs.	List Price
CTC-7J8955	2	3.16
CTC-7X4757	2	3.55
CTC-7X4807	2	2.84
CTC-7Y4628	1	23.26
CTC-7Y4633	1	7.18
CTC-7Y4669	1	22.67
CTC-7Y4673	1	7.80
CTC-7Y4945	1	7.03
CTC-7Y5116	1	22.08
CTC-8J0548	2	3.16
CTC-8J1666	2	3.16
CTC-8J1689	3	2.23
CTC-8J1717	2	2.68
CTC-8J2574	6	.89
CTC-8J3752	4	1.57
CTC-8J4385	2	3.16
CTC-8J8880	1	5.34
CTC-9J0240	9	.59
CTC-9J0705	10	.54
CTC-9J7861	3	1.86
CTC-9X4596	1	5.34
CTC-9X7273	2	3.16
CTC-9X7278	4	1.74
CTC-9X7279	3	1.86
CTC-A04700414	1	16.26
CTC-A04700712	1	6.59

D-RINGS

Part Number	I.D.	List Price
CTC-1P3700	19.0 mm	\$.90
CTC-1P3702	25.4 mm	1.01
CTC-1P3703	31.9 mm	1.20
CTC-1P3704	38.2 mm	1.30
CTC-1P3705	44.7 mm	1.39
CTC-1P3706	51.1 mm	1.49
CTC-1P3707	54.2 mm	1.53
CTC-1P3708	57.4 mm	1.61
CTC-1P3709	63.9 mm	1.69



REPLACEMENT KITS FOR CATERPILLAR® EQUIPMENT

NOTE: Caterpillar® part numbers are used as a reference only. We do not imply that these kits are original REPLACEMENT PARTS.

CAT D-RING KIT

This handy kit, in an unbreakable box, contains the 9 most popular sized D-Rings used on Caterpillar® equipment.

Part Number: CTC-4C4784
List Price: \$ 111.57



CAT SILICONE O-RING KIT

This handy kit, in an unbreakable box, contains 149 silicone o-rings in the 32 most popular sizes used on Caterpillar® equipment

Part Number: CTC-4C8253
List Price: \$ 300.51



CAT KIT FACE KIT

This handy kit contains a total of 120 90 Durometer O-Rings in 8 different sizes.

Part Number: CTC-4C5859
List Price: \$ 52.25



CAT NITRILE O-RING KIT

This handy kit, in an unbreakable box, contains 570 nitrile o-rings in the 32 most popular sizes used on Caterpillar® equipment.

Part Number: CTC-4C4782
List Price: \$ 188.50



REPLACEMENT PARTS FOR CATERPILLAR® EQUIPMENT

NOTE: Caterpillar® part numbers are used as a reference only. We do not imply that these kits are original REPLACEMENT PARTS.

“NYLON INSERT” LOCKING NUTS

Manufactured from the finest quality steel and heat treated to offer superior strength, the locking nuts with nylon inserts are specifically designed and manufactured to exact dimensions. The high temperature locking inserts are designed to withstand the high temperatures associated with close tolerance performance applications.

Part Number	Thread Size & Pitch	Height	O.D.	List Price
CTC-2J0564	2 - 12	3-1/8	1-5/8	\$ 61.66
CTC-2J3247	1-3/4 - 12	2-3/4	1-7/16	42.77
CTC-2J3950	1-1/2 - 12	2-3/8	1-5/16	24.23
CTC-2J6384	1-1/4 - 12	2	1-1/8	21.59
CTC-2J7686	2-1/2 - 12	4	2-3/16	140.53
CTC-3J6899	2-1/4 - 12	3-1/2	2-13/16	141.61
CTC-3J9449	2-1/2 - 12	4	2-5/8	162.29
CTC-3J9545	2 - 12	3-1/8	2-7/16	100.93
CTC-4J6888	2-3/4 - 12	4	2-1/4	114.29
CTC-4J8734	2-3/4 - 12	4	3-1/8	196.14
CTC-5J3488	2-1/4 - 12	3-1/2	1-15/16	103.95
CTC-5J5731	1-3/4 - 12	2-1/2	1-7/16	28.92
CTC-7J9250	3-1/4 - 12	4-1/2	3-1/8	209.74
CTC-7Y4622	72 mm - 2		105 mm	273.06
CTC-7Y4695	80 mm - 2		115 mm	261.18
CTC-7Y4956	90 mm - 2		130 mm	312.76
CTC-8T3018	36 mm - 4		55 mm	40.32
CTC-8T5065	30 mm - 3.5		46 mm	26.31
CTC-9X6018	4.00 - 12		3.725	490.44
CTC-0875385	95 mm - 2		135 mm	389.52
CTC-0875504	64 mm - 2		95 mm	223.62
CTC-1163513	105 mm - 2		150 mm	672.54
CTC-1163516	120 mm - 2		170 mm	743.95
CTC-1232060	80 mm - 2		115 mm	185.18
CTC-1232112	90 mm - 2		130 mm	327.75
CTC-1261971	100 mm - 2		146 mm	747.42

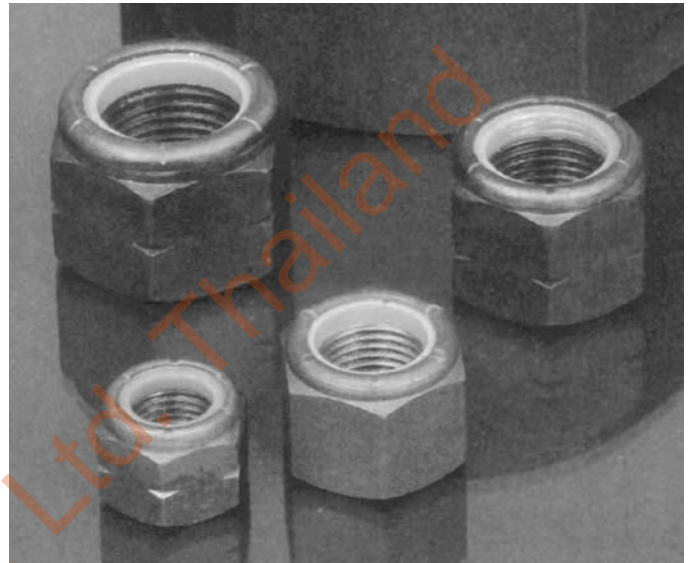

REPLACEMENT PARTS FOR CATERPILLAR TOWMOTOR LIFT TRUCKS

NOTE: If you can locate the cylinder group number, it can aid in identifying the proper kit.

Kit Number	Code (Pg. x)	Rode X Bore Size	List Price	Kit Number	Code (Pg. x)	Rode X Bore Size	List Price
TM-1033947	I-U-10	40 X 90 mm	\$ 47.95	TM-396846	P-UB-10	2 X 4-1/2	\$ 59.04
TM-1040763	P-U-1	70 mm	37.68	TM-396847	I-V-8	2 X 4.525	38.43
TM-1040900	I-U-10	37 X 71 mm	25.84	TM-396848	P-UB-11	1-1/4 X 3	27.87
TM-1040948	P-U-1	35 mm	19.18	TM-396849	I-V-8	2 X 5.025	44.13
TM-1041095	P-U-1	40 x 50 mm	63.71	TM-659060	O-RINGS		4.69
TM-1042519	P-U-1	85 X 100 mm	45.51	TM-690003	I-U-5	2 X 5	67.72
TM-1042609	P-U-4	45 X 55 mm	48.68	TM-691389	I-OB-3	1-1/2 X 2-1/2	14.61
TM-1146727	P-U-14	50 X 110 mm	69.60	TM-693683	O-RINGS		5.61
TM-324908	I-V-8	2 X 4.525	41.89	TM-694526	I-UB-5	2 X 5	64.89
TM-324958	P-I-N-8	3 X 4.025	51.68	TM-694527	I-UB-5	2-1/2 X 6	71.75
TM-375427	I-U-11	1 X 2-1/2	11.38	TM-694528	I-U-4, 10	2 X 4-1/2	44.04
TM-376968	I-U-1	2-1/2 Rod	22.26	TM-695522	I-UB-5	1-1/4 X 3-1/2	46.59
TM-388594-6	P-UB-10	1-1/2 X 3-1/2	27.14	TM-695523	I-UB-5	1-1/2 X 4	55.62
TM-396743	I-P-N-8	3 X 4.025	60.10	TM-901523	I-U-1	2-1/2, 3-1/4, 4 Stages	101.82
TM-396744	I-U-8	2-1/2 X 3.525	26.96	TM-905761	P-U-1	3-1/8, 4-3/8 Stages	132.58
TM-396746	I-P-U-1	2-1/4, 3-1/4, 4-1/8 Stages	92.55	TM-905771	P-U-1	2-3/8, 4-3/8 Stages	107.37
TM-396747	P-U-8	3 X 3.525	37.03	TM-905961	VALVE KIT		7.57
TM-396748	I-U-8	3 X 4.025	34.20	TM-905962	VALVE KIT		3.55
TM-396749	P-U-1	3-1/8, 4-3/8, 5 Stages	157.30	TM-906496	I-U-10	3 X 4	36.19
TM-396750	P-U-1	2-3/16 X 2-1/2	31.68	TM-911700	I-U-1	75 mm Rod Kit	30.22
TM-396751	P-U-8	3-3/4 X 5.025	56.96	TM-911701	I-U-N	50 mm Rod Kit	32.14
TM-396752	I-U-8	2-5/8 X 3.025	40.87	TM-911725	I-O-10	25 X 50 mm	32.02
TM-396754	I-U-8	2-1/2 X 3.025	26.84	TM-911726	I-U-10	35 X 80 mm	38.76
TM-396755	I-U-8	3 X 3.525	32.56	TM-911956	P-U-1	1-5/8 Rod Kit	15.90
TM-396756	I-P-1-8	3 X 4.025	49.56	TM-912067	P-UB-10	1-1/4 X 3	20.82
TM-396757	P-U-1	2-3/8, 4-3/8, 5 Stages	146.79	TM-912711	P-U-1	2-3/8 Rod Kit	24.71
TM-396758	I-P-U-1	1-7/8, 2-3/4, 3-5/8 Stages	80.22	TM-912748	P-U-1	2-3/8 Rod Kit	24.78
TM-396759	I-V-1	2.700, 3.450, 5.700 Stgs.	100.59	TM-914206	P-UB-10	2 X 4-1/2	43.84
TM-396760	I-V-1	2.200, 2.950, 4.700 Stgs.	78.24	TM-914634	I-U-N	3-3/4" Rod	26.47
TM-396761	I-P-N-8	3 X 5.025	68.42	TM-914635	I-U-10	2 X 2-1/2	45.87
TM-396801	P-U-1	3-3/8, 4-3/8, 5 Stages	174.37	TM-914636	N-U-10	4 X 4-1/2	68.80
TM-396842	P-UB-10	1-1/2 X 3-1/2	26.26	TM-918024	P-U-4	150 X 180 mm	254.40
TM-396843	P-U-11	1-1/2 X 3-1/2	20.01	TM-919851	P-U-15	120 X 180 mm	462.96
TM-396844	P-UB-11	1-1/2 X 3-1/2	20.96	TM-920666	I-U-N	50 mm Rod Kit	26.29
TM-396845	I-U-11	1-1/4 X 3	15.62	TM-923282	I-U-10	2 X 2-1/2	72.66

Part Number	Type	O.D.	I.D.	Hgt.	List Price
TM-5461	Vee Set	1-1/4	1-3/4VS		\$ 5.31
TM-41248	Vee Set	2.200	2.700	1	12.58
TM-41250	Vee Set	2.950	3.450	1	14.34
TM-41252	Vee Set	4.700	5.290	1	25.11
TM-41340	Vee Set	4.025	5.025	1.3	30.34
TM-67841	Vee Set	2.700	3.450		16.40
TM-67842	Vee Set	3.450	4.250	1.5	29.64
TM-67843	Vee Set	5.700	6.450		31.85
TM-303231	Wiper	1	1-3/8	3/16	1.62
TM-303260	Vee Set	2.275	3.025	1.2	13.82
TM-371212	Modular Back-up Ring	5	5-3/4	.226	23.29
TM-903016	Wiper	5	5-3/4	3/8	16.85

CHAMPION MOTOR GRADER

Kit Number	Code (Pg. x)	Rode X Bore Size	List Price
CHMP-26408	1-3/8 X 3	I-U-5	\$ 29.07
CHMP-26409	2 X 4	I-U-5	41.92
CHMP-26410	2 X 5	I-U-5	56.70

CHARLYNN SEAL KITS

Charlynn Model Identification

XXX - XXX - XXX
 Product - Product - Engineering
 Line Identification Change Code

Kit Number	Series	Description	Model Number	List Price
CHR-60023	H	Buna N Seal Kit	101-XXXX-007	\$ 40.89
CHR-60026	S	Buna N Seal Kit	103-XXXX-007	42.15
CHR-60036	H	Buna N Seal Kit	101-XXXX-005	32.01
CHR-60042	S	Buna N Seal Kit	103-XXXX-006	42.38
CHR-60533	S	Buna N Seal Kit	103-XXXX-008	39.34
CHR-60539	S	Buna N Seal Kit	103-XXXX-009;-010	48.39
CHR-60540	A	Buna N Seal Kit	130-XXXX-002;-003	48.39
CHR-61000	3000	Viton Seal Kit	107-XXXX-004	93.48
CHR-61104	6000	Shaft Seal Kit	112-XXXX-002;-003;-004	82.50
CHR-61105	6000	Rear Motor Kit	112-XXXX-002;-003;-004	30.17
CHR-61234	4000	Rear Motor Kit	109-XXXX-004	28.06
CHR-61236	4000	Shaft Seal Kit	109-XXXX-004	44.19
CHR-61237	6000	Shaft Seal Kit	112-XXXX-005	44.74
CHR-61238	6000	Rear Motor Kit	112-XXXX-005	40.25
CHR-61252	2000	Buna N Seal Kit	104-XXXX-003;-004;-005	63.62
CHR-61258	2000	Buna N Seal Kit	104-XXXX-006	63.90
CHR-61259	2000	Buna N Seal Kit	106-XXXX-006	31.02
CHR-6405	10,000	Motor Seal Kit	119-XXXX-002;-003;-004	54.94
CHR-6406	10,000	Shaft Seal Kit	119-XXXX-001;-002;-003;-004	59.15
CHR-64417	Steering unit with external shaft			24.79
CHR-64418	Steering unit with internal spline			26.85
CHR-64468	25	Buna N Seal Kit	251-XXXX-001;252-XXXX-001;253-XXXX-001	58.29

CHIEF CYLINDERS

Kit Number	Code (Pg. x)	Rod X Bore Size	List Price	Kit Number	Code (Pg. x)	Rod X Bore Size	List Price
CTR-203-001	P-OB-3	1-1/8" x 2"	\$ 6.06	CTR-781-036	I-U-1	4" Rod Kit	\$ 29.62
CTR-203-002	P-OB-3	1-1/8" x 2-1/2"	6.36	CTR-781-038	I-U-1	5" Rod Kit	44.99
CTR-203-004	P-OB-3	1-1/4" x 3-1/2"	7.24	CTR-781-039	I-U-1	1-1/8" Rod Kit	7.19
CTR-203-005	P-OB-3	1-1/2" x 3-1/2"	7.48	CTR-781-042	I-U-1	2-3/4" Rod Kit	18.42
CTR-203-006	P-OB-3	1-1/4" x 4"	7.12	CTR-781-043	I-U-1	1" Rod Kit	7.07
CTR-203-011	P-OB-3	1-1/4" x 2-3/8"	5.89	CTR-781-044	I-U-1	1-1/8" Rod Kit	7.42
CTR-203-029	P-OB-3	1-1/2" x 3"	7.07	CTR-781-049	I-U-1	2" Rod Kit	14.05
CTR-203-150	P-U-10	1" x 1-1/2"	9.25	CTR-781-100	N-N-10	2" Piston Kit	5.12
CTR-203-151	P-U-10	1-1/4" x 2"	12.37	CTR-781-101	N-N-10	2-1/2" Piston Kit	5.42
CTR-203-152	P-U-10	1-3/8" x 2-1/2"	13.64	CTR-781-102	N-N-10	3" Piston Kit	8.30
CTR-203-153	P-U-10	1-1/2" x 3"	13.64	CTR-781-103	N-N-10	3-1/2" Piston Kit	9.01
CTR-781-007	I-U-1	1-1/2" Rod Kit	10.42	CTR-781-104	N-N-10	4" Piston Kit	9.13
CTR-781-008	I-U-1	1-3/4" Rod Kit	12.54	CTR-781-105	N-N-10	4-1/2" Piston Kit	11.36
CTR-781-009	I-U-1	2" Rod Kit	13.84	CTR-781-107	N-N-10	5-1/2" Piston Kit	12.60
CTR-781-013	I-U-1	1-3/4" Rod Kit	9.95	CTR-781-108	N-N-10	6" Piston Kit	16.63
CTR-781-014	I-U-1	2" Rod Kit	15.04	CTR-781-201	N-N-10	7" Piston Kit	21.14
CTR-781-015	I-U-1	2-1/4" Rod Kit	15.96	CTR-781-203	N-N-10	9" Piston Kit	50.41
CTR-781-020	I-U-1	2" Rod Kit	15.84	CTR-781-204	N-N-10	10" Piston Kit	74.60
CTR-781-021	I-U-1	2-1/2" Rod Kit	18.02	CTR-781-206	N-N-10	12" Piston Kit	123.43
CTR-781-022	I-U-1	2-3/4" Rod Kit	19.21	CTR-781-303	I-U-1	4" Rod Kit	21.53
CTR-781-028	I-U-1	3" Rod Kit	20.87	CTR-781-305	I-U-1	2-1/4" Rod Kit	12.01
CTR-781-029	I-U-1	3 1/2" Rod Kit	23.45	CTR-781-310	I-U-1	1-1/4" Rod Kit	7.36
CTR-781-030	I-U-1	4" Rod Kit	26.30	CTR-781-312	I-U-1	1-3/4" Rod Kit	9.54
CTR-781-034	I-U-1	4" Rod Kit	28.09	CTR-781-313	I-U-1	2" Rod Kit	10.83
CTR-781-035	I-U-1	3-1/2" Rod Kit	28.82				

CLARK LIFT TRUCKS

NOTE: A Clark deck number can positively identify the kit needed for lift cylinders. Looking at the upright (lift mechanism) from the driver's seat, the deck number is stamped on the right outer channel.

SAMPLE: MO141, HO351, FO168, etc.

ALSO NOTE: Kits with an "E" suffix contain original equipment u-seals. Kits without "E" suffix contain specially designed seals.

Kit Number	Code (Pg. x)	Rod X Bore Size	List Price	Kit Number	Code (Pg. x)	Rod X Bore Size	List Price
CLK-1795529	I-U-5	1-1/2 X 4	\$ 39.99	CLK-1811164		1-3/4, 2-5/8, 3-3/8, 4-5/8 UID'S	\$ 65.66
CLK-1810820	O-RINGS		6.99	CLK-1811164-E		1-3/4, 2-5/8, 3-3/8, 4-5/8 UID'S	128.41
CLK-1811046	I-U-10	1-1/4 X 3	16.00	CLK-1811179	I-V-5	1-1/2 X 4	54.20
CLK-1811107	I-N-4	2 X 2-1/4	17.35	CLK-1811180	I-V-5	1-1/4 X 4	49.69
CLK-1811108	I-N-4	2-1/4 X 2-1/2	13.42	CLK-1811184	I-V-5	1-1/4 X 3	41.47
CLK-1811120		1-3/4, 3-1/8 VID, 3-7/8, 5-1/4 UID	97.14	CLK-1811200	I-V-4	2 X 6	98.07
CLK-1811120-E		1-3/4, 3-1/8 VID, 3-7/8, 5-1/4 UID	157.63	CLK-1811200-E	I-V-4	2 X 6	184.03
CLK-1811122		2-1/8 VID, 3-7/8, 4-3/4, 6-1/2 UID	130.41	CLK-1811204	I-V-1	1-1/4 ROD	53.77
CLK-1811122-E		2-1/8 VID, 3-7/8, 4-3/4, 6-1/2 UID	181.53	CLK-1811206	I-V-5	3/4 X 1-5/8	24.77
CLK-1811123		3-1/4, 4-1/4 VID'S, 6-1/2 UID'S	144.65	CLK-1811207	I-V-5	1 X 2	35.93
CLK-1811123-E		3-1/4, 4-1/4 VID'S, 6-1/2 UID'S	191.39	CLK-1811209	I-V-5	1 X 2-1/4	40.51
CLK-1811124		2-1/8, 3-1/8 VID'S	56.42	CLK-1811210	I-V-5	1-1/4 X 2-3/4	50.18
CLK-1811125		2-1/8, 3-1/8, 4-1/2 VID'S	103.29	CLK-1811212	I-V-5	1-1/4 X 3-1/4	52.25
CLK-1811126		2-3/4, 3-3/4, 5-3/4 VID'S	135.96	CLK-1811217	I-V-5	1-3/4 X 4-1/2	39.68
CLK-1811127		2-3/4, 3-3/4, 5-3/4 VID'S	139.10	CLK-1811218	I-V-5	2 X 6	208.84
CLK-1811129	I-N-4	2-1/2 X 4	28.15	CLK-1811231	N-N-5	2.26" Piston Kit	26.97
CLK-1811130		1-3/4, 2-5/8, 3-3/4 VID'S	81.22	CLK-1811244	I-U-10	1-1/8 X 2-1/4	12.30
CLK-1811131		1-3/4, 3-1/8 VID, 3-7/8, 5-1/4 UID	104.07	CLK-1811275	I-V-5	1-1/2 X 4	41.00
CLK-1811131-E		1-3/4, 3-1/8 VID, 3-7/8, 5-1/4 UID	142.01	CLK-1811309	I-U-10	1 X 3	9.18
CLK-1811132		1-3/4, 2-5/8 VID, 3-3/8, 4-1/2 UID	74.04	CLK-1811314		1-3/4 VID, 3-1/8, 3-7/8, 5-1/4 UID	86.11
CLK-1811132-E		1-3/4, 2-5/8 VID, 3-3/8, 4-1/2 UID	115.54	CLK-1811314-E		1-3/4 VID, 3-1/8, 3-7/8, 5-1/4 UID	123.10
CLK-1811133		1-3/4, 2-5/8 VID'S	38.50	CLK-1811315		1-3/4 VID, 3-1/8, 3-7/8, 5-1/4 UID	98.12
CLK-1811138		2-1/4, 3-1/4 VID'S	68.54	CLK-1811315-E		1-3/4 VID, 3-1/8, 3-7/8, 5-1/4 UID	124.90
CLK-1811142		1-3/4, 2-5/8, 3-3/4 VID'S	132.52	CLK-1811327		2-1/8 VID, 3-7/8, 4-3/4, 6-1/2 UID	115.05
CLK-1811148		2-1/8 VID, 3-7/8, 4-3/4, 6-1/2 UID	136.78	CLK-1811327-E		2-1/8 VID, 3-7/8, 4-3/4, 6-1/2 UID	181.33
CLK-1811148-E		2-1/8 VID, 3-7/8, 4-3/4, 6-1/2 UID	182.15	CLK-1811369	P-U-4	60 mm X 73 mm	43.32
CLK-1811149	I-U-4	3-1/2 X 4-3/4	62.74	CLK-1811376	I-U-10	40 mm X 4"	32.45
CLK-1811154	I-U-1	2-1/2 X 3-1/4	18.18	CLK-1811392	P-U-10	1-3/4 X 3	42.21
CLK-1811155	I-N-4	2-1/2 X 3	17.15	CLK-1811393	I-U-10	40 mm X 4"	35.89
CLK-1811157	I-U-5	5 X 7	115.73	CLK-1811415	P-U-4	60 X 78 mm	44.94
CLK-1811158	I-U-5	4-1/2 X 6	87.75	CLK-1811537	P-U-1	60 mm	45.16
CLK-1811158-E	I-U-5	4-1/2 X 6	108.43	CLK-1811538	I-U-4	40 X 56 mm	38.34
CLK-1811159		1-3/4, 3-1/8 VID, 3-7/8, 5-1/4 UID	98.25	CLK-1811542	I-U-10	1-3/8 X 3	20.98
CLK-1811159-E		1-3/4, 3-1/8 VID, 3-7/8, 5-1/4 UID	142.58	CLK-1811544	I-U-10	1 X 2	32.65
CLK-1811160		1-3/4, 2-5/8 VID, 3-3/8, 4-1/2 UID	73.51	CLK-1811569	P-U-10	2 X 3-3/8	31.83
CLK-1811160-E		1-3/4, 2-5/8 VID, 3-3/8, 4-1/2 UID	115.54	CLK-1811582	I-U-10	1-1/4 X 3-1/2	19.37
CLK-1811161		1-3/4, 3-1/8 VID, 3-7/8, 5-1/4 UID	99.00	CLK-1811691	P-U-1	2 X 2.450	19.99
CLK-1811161-E		1-3/4, 3-1/8 VID, 3-7/8, 5-1/4 UID	138.01	CLK-1811697	I-U-10	1-1/4 X 3-1/2	19.45
CLK-1811162		2-1/8, 3-1/8, 4-1/2 UID'S	105.31	CLK-1811719	I-U-10	40 mm X 3-1/2	23.14
CLK-1811163		2-1/8, 3-1/8, 4-1/2 VID'S	106.22	CLK-1811759	I-U-10	1-1/4 X 3	19.67

CLARK LIFT TRUCKS

CLARK

Kit Number	Code (Pg. x)	Rod X Bore Size	List Price
CLK-1811785	I-U-10	40 mm x 3-1/2	\$ 27.07
CLK-1811799	I-U-10	2 X 3-3/8	48.96
CLK-1811820	I-U-10	2 X 3	19.44
CLK-1811828	I-U-10	2 X 3	17.98
CLK-1811852	I-U-1	3 X 3-1/2	39.95
CLK-1811855	P-U-1	60 mm X 72 mm	27.37
CLK-1811972	I-U-10	1-1/4 X 3	25.45
CLK-1813014	P-U-1	2 X 2-1/2	23.36
CLK-1813015	I-U-1	2-5/8 Rod Kit	44.68
CLK-1813016	I-U-1	3 X 3-1/2	35.41
CLK-1813017	P-U-1	60mm X 72 mm	27.37
CLK-1813023	I-U-1	40 mm X 2-3/16"	26.79
CLK-1813024	I-U-1	40 mm Rod Kit	13.37
CLK-1813032	I-U-10	50 mm X 3-3/8"	42.76
CLK-1813055	I-U-10	50 mm X 3-1/8"	47.70
CLK-1813075	I-U-10	40 mm X 3-1/2"	26.48
CLK-1813076	I-U-10	40 mm X 4"	28.29
CLK-1813082	I-U-10	50 X 86 mm	39.14
CLK-1813084	I-U-1	50 mm Rod Kit	15.36
CLK-1813176	I-U-4	60 X 73 mm	48.11
CLK-1818816	P-U-10	3/4 X 1-3/4	17.15
CLK-1818864	P-U-10	3/4 X 2	12.73
CLK-1821328	I-U-10	7/8 X 2	8.94
CLK-1830350	I-N-4	2 X 2-1/4	18.76
CLK-1830352	I-N-4	3-1/4 X 4	25.22
CLK-1830358	I-N-4	2-1/2 X 3-1/4	30.85
CLK-1830360	I-N-4	2-1/2 X 3	19.10
CLK-1830361	I-N-4	2-1/4 X 2-1/2	21.01
CLK-1830649	I-U-10	3/4 X 2-3/4	20.79

Kit Number	Code (Pg. x)	Rod X Bore Size	List Price
CLK-1831042		1-1/4" Rod Kit	\$ 6.26
CLK-1831074	I-U-10	1-3/4 X 4-1/2	27.60
CLK-1831075	I-V-1	3-1/4 Rod Kit	27.53
CLK-1831076	I-U-10	1-1/8 X 2-1/2	17.35
CLK-2367420	I-U-1	2-1/4 X 3-1/4	66.15
CLK-3009626	P-U-10	25 mm X 50 mm	43.93
CLK-3986876	MOTOR KIT		16.43
CLK-841270	P-U-10	2 X 3-3/4	22.55
CLK-886547	P-TR-12	1 X 2	28.29
CLK-888348	PUMP KIT		10.60
CLK-896505	MOTOR KIT		4.61
CLK-905074	MOTOR KIT		10.19
CLK-907984	VALVE KIT		11.53
CLK-908985	VALVE KIT		11.01
CLK-912339	P-U-1	2-1/2 X 3	23.62
CLK-914698	I-U-4	1 X 2-1/2	17.49
CLK-914703	I-O-4	1-1/4 X 3	11.68
CLK-916351	MULTI STAGE	4, 4-3/4	353.15
CLK-917282	O-RING KIT		5.06
CLK-917713	N-N-10	2" Piston Kit	14.16
CLK-918886	I-U-10	2 X 3-3/8	24.30
CLK-921115A	VALVE KIT		6.70
CLK-990076	VALVE KIT		2.83
CLK-990208	SWIVEL KIT		4.51
CLK-990209	SWIVEL KIT		6.43
CLK-992511	O-RING KIT		4.63
CLK-994287	VALVE KIT		7.98
CLK-995815	SWIVEL KIT		6.75
CLK-999820	P-U-10	3/4 X 1-3/4	22.23

**FOR CLARK-MICHIGAN CONSTRUCTION EQUIPMENT
SEE OUR LISTING OF KITS UNDER THE VOLVO SECTION IN THIS CATALOG.**



COMMERCIAL HYDRAULICS

- PACKING:** Vee packing with nylon top and bottom adaptors. 5/16" cross section.
- WIPERS:** .190 shoulder thickness on wipers.
- BEARINGS:** One above packing - may be either bronze or nylon.
- PISTON:** Welded to stage. Single action uses single nylon wear ring. Double action uses 3 cast iron piston rings and 2 nylon wear rings.
- STAGE O.D.'s:** 2.750; 3.750; 4.750; 5.750; 6.750; 7.905; 9.375
- SPECIAL INFO.:** Threaded internal stop ring. Uses wave spring under vee packing.
- IDENTIFICATION:** Cylinder number stamped on metal tag on cylinder body.
Ex: SD85MC-15-220 double acting
S85DC-40-190 single acting

COMMERCIAL

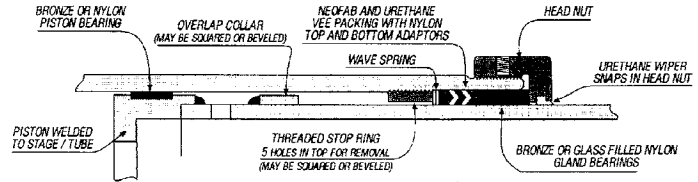

CYLINDER REBUILD KITS SINGLE ACTING DUMP BODY CYLINDERS

Kit includes: Wiper Rings, Packing Assemblies, Bearing Rings, Piston Bearings, Wave Springs, Set Screws & Nylon Balls

Part Number	Cyl. Model Number	List Price
CM-375-1804-017	S53	\$ 123.79
CM-375-1804-020	S62	113.24
CM-375-1804-018	S63	154.22
CM-375-1804-021	S64	186.08
CM-375-1804-019	S73	194.94
CM-375-1804-022	S74	254.46
CM-375-1804-023	S84	293.97
CM-375-1804-024	S85	348.05
CM-375-1804-025	S95	504.06

CYLINDER REPACK KITS SINGLE ACTING DUMP BODY CYLINDERS

Kit includes: Wiper Rings, Packing Assemblies

Part Number	Cyl. Model Number	List Price
CM-391-1804-020	S53	\$ 53.43
CM-375-1804-026	S62	50.07
CM-391-1804-109	S63	67.65
CM-391-1804-237	S64	81.41
CM-375-1804-002	S73	90.82
CM-375-1804-003	S74	108.41
CM-391-1804-054	S84	134.13
CM-391-1804-060	S85	151.72
CM-375-1804-004	S95	223.60

Part Number	Description	List Price
-------------	-------------	------------

PACKING & WIPERS (INCLUDES SHIMS)		
Part Number	Description	List Price
CM-3VSW	2-3/4" Vee Set & Wiper	\$ 13.82
CM-4VSW	3-3/4" Vee Set & Wiper	17.61
CM-5VSW	4-3/4" Vee Set & Wiper	22.03
CM-6VSW	5-3/4" Vee Set & Wiper	28.05
CM-7VSW	6-3/4" Vee Set & Wiper	40.74
CM-8VSW	7.905" Vee Set & Wiper	43.32
CM-9.37VSW	9-3/8" Vee Set & Wiper	89.45

Part Number	Description	List Price
-------------	-------------	------------

GLAND BEARINGS		
CM-275NB	2-3/4" Gland Bearing	\$ 11.82
CM-375NB	3-3/4" Gland Bearing	11.85
CM-475NB	4-3/4" Gland Bearing	18.18
CM-575NB	5-3/4" Gland Bearing	20.89
CM-675NB	6-3/4" Gland Bearing	22.48
CM-790NB	7.905" Gland Bearing	33.89
CM-937NB	9-3/8" Gland Bearing	71.87

GLAND BEARINGS KITS		
CM-NYB35	2-3/4" - 4-3/4" Gland Bearings	\$ 41.81
CM-NYB46	3-3/4" - 5-3/4" Gland Bearings	50.88
CM-NYB47	3-3/4" - 6-3/4" Gland Bearings	73.36
CM-NYB48	3-3/4" - 7.905" Gland Bearings	107.24
CM-NYB49	3-3/4" - 9-3/8" Gland Bearings	179.11
CM-NYB57	4-3/4" - 6-3/4" Gland Bearings	61.54
CM-NYB58	4-3/4" - 7.905" Gland Bearings	95.43

NYLON PISTON BEARINGS		
CM-U3023-32	2-3/4" Piston Bearing	\$ 3.05
CM-U3023-42	3-3/4" Piston Bearing	4.55
CM-U3023-52	4-3/4" Piston Bearing	4.60
CM-U3023-62	5-3/4" Piston Bearing	5.20
CM-U3023-72	6-3/4" Piston Bearing	5.95
CM-U3023-84	7.905" Piston Bearing	7.05
CM-U3023-98	9-3/8" Piston Bearing	14.29
CM-X29-1	Bleeder Valve	2.48

BRONZE PISTON BEARINGS		
CM-U3023-52B	4-3/4" Bronze Piston Bearings	\$ 34.06
CM-U3023-62B	5-3/4" Bronze Piston Bearings	37.65
CM-U3023-72B	6-3/4" Bronze Piston Bearings	41.19
CM-U3023-84B	7.905" Bronze Piston Bearings	67.55
CM-U3023-98B	9-3/8" Bronze Piston Bearings	57.46

COMMERCIAL HYDRAULICS

Part Number	Description	List Price
PISTON RINGS (Double Acting)		
CM-275NB	2-3/4" Gland Bearing	\$ 11.82
CM-375NB	3-3/4" Gland Bearing	11.85
CM-475NB	4-3/4" Gland Bearing	18.18
CM-575NB	5-3/4" Gland Bearing	20.89
CM-675NB	6-3/4" Gland Bearing	22.48
CM-790NB	7.905" Gland Bearing	33.89
CM-937NB	9-3/8" Gland Bearing	71.87
GLAND BEARINGS KITS		
CM-NYB35	2-3/4" - 4-3/4" Gland Bearings	\$ 41.81
CM-NYB46	3-3/4" - 5-3/4" Gland Bearings	50.88
CM-NYB47	3-3/4" - 6-3/4" Gland Bearings	73.36
CM-NYB48	3-3/4" - 7.905" Gland Bearings	107.24
CM-NYB49	3-3/4" - 9-3/8" Gland Bearings	179.11
CM-NYB57	4-3/4" - 6-3/4" Gland Bearings	61.54
CM-NYB58	4-3/4" - 7.905" Gland Bearings	95.43
NYLON PISTON BEARINGS		
CM-U3023-32	2-3/4" Piston Bearing	\$ 3.05
CM-U3023-42	3-3/4" Piston Bearing	4.55
CM-U3023-52	4-3/4" Piston Bearing	4.60
CM-U3023-62	5-3/4" Piston Bearing	5.20
CM-U3023-72	6-3/4" Piston Bearing	5.95
CM-U3023-84	7.905" Piston Bearing	7.05
CM-U3023-98	9-3/8" Piston Bearing	14.29
CM-X29-1	Bleeder Valve	2.48
BRONZE PISTON BEARINGS		
CM-U3023-52B	4-3/4" Bronze Piston Bearings	\$ 34.06
CM-U3023-62B	5-3/4" Bronze Piston Bearings	37.65
CM-U3023-72B	6-3/4" Bronze Piston Bearings	41.19
CM-U3023-84B	7.905" Bronze Piston Bearings	67.55
CM-U3023-98B	9-3/8" Bronze Piston Bearings	57.46
CM-NYB58	4-3/4"-7.905" Gland Bearings	95.43
CM-NYB69	5-3/4"-9-3/8" Gland Bearings	114.02
CM-PR48	3-3/4"-7.905" Piston Rings	208.52
CM-PR58	4-3/4"-7.905" Piston Rings	182.37
THREADED STOPS		
CM-F3020	3-3/4" Threaded Stop Ring	\$ 31.20
CM-F4020	2-3/4" Threaded Stop Ring	28.84
CM-F5020	5-3/4" Threaded Stop Ring	48.06
CM-F6020	4-3/4" Threaded Stop Ring	40.93
CM-F7020	6-3/4" Threaded Stop Ring	51.46
CM-F9020	9-3/8" Threaded Stop Ring	153.35
CM-G8020	7.905" Threaded Stop Ring	75.53

Part Number	Description	List Price
BEVELED STOP RINGS		
CM-375-3020-110	2-13/16 X 3-3/8 X 1	\$ 19.24
CM-375-3020-111	3-13/16 X 4-3/8 X 1	19.64
CM-375-3020-112	4-13/16 X 5-3/8 X 1	22.22
CM-375-3020-113	5-13/16 X 6-3/8 X 1	26.02
CM-375-3020-114	6-13/16 X 7-3/8 X 1	30.24
CM-375-3020-119	9-7/16 X 10 X 2	162.15
CM-375-3020-120	8 X 8-1/2 X 2	64.41
HEAD NUTS (MEASURED AT WIPER I.D.)		
CM-MA3011-37	3-3/4" Bronze Internal Head Nut	\$ 102.71
CM-MA3011-47	4-3/4" Bronze Internal Head Nut	129.74
CM-MA3011-57	5-3/4" Bronze Internal Head Nut	167.59
CM-MA3011-67	6-3/4" Bronze Internal Head Nut	189.21
CM-MA3011-79	7.905" Bronze Internal Head Nut	247.59
CM-MA3011-93	9-3/8" Bronze Internal Head Nut	367.61
CM-YA3011-37	3-3/4" Steel External Head Nut	48.87
CM-YA3011-47	4-3/4" Steel External Head Nut	51.74
CM-YA3011-57	5-3/4" Steel External Head Nut	52.06
CM-YA3011-67	6-3/4" Steel External Head Nut	77.63
CM-YA3011-79	7.905" Steel External Head Nut	114.61
CM-YA3011-93	9-3/8" Steel External Head Nut	207.59
VALVE SERVICE KITS		
CM-391-1803-030	Valve Series A20 Service Kit	\$ 3.46
CM-391-1803-201	Valve Series A35 Service Kit	12.84
WAVE SPRINGS		
CM-P1327-27	2-3/4" Wave Spring	\$ 7.30
CM-P1327-37	3-3/4" Wave Spring	4.30
CM-P1327-47	4-3/4" Wave Spring	7.03
CM-P1327-57	5-3/4" Wave Spring	9.62
CM-P1327-67	6-3/4" Wave Spring	12.82
CM-P1327-79	7.905" Wave Spring	17.68
CM-P1327-93	9-3/8" Wave Spring	51.90



CROSS

Kit Number	Code (Pg. x)	Rod X Bore Size	List Price
CR-1C 1480	P-U-5	1-1/16 X 2	\$ 19.61
CR-1C 4147	P-OB-3	1-1/8 X 3	8.85
CR-1C 4244	P-OB-3	1-1/16 X 2	11.14
CR-1C 4429	P-OB-3	1-1/4 X 3-1/2	10.03
CR-1C 4430	P-OB-3	1-1/4 X 4	10.49
CR-1C 4433	P-OB-3	1-1/16 X 2-1/2	11.61
CR-1C 4629	P-OB-3	1-1/4 X 3	7.62
CR-1C 4630	P-OB-3	1-1/2 X 3	7.79
CR-1C 4631	P-OB-3	1-1/2 X 3-1/2	10.28
CR-1C 4637	P-OB-3	1-1/2 X 4	14.74
CR-1C 4638	P-OB-3	2 X 4	10.36
CR-1C 4642	P-OB-3	3/4 X 1-1/2	13.03
CR-1C 4750	P-OB-3	1 X 2	7.79
CR-1C 4759	P-OB-3	1-1/4 X 2-1/2	8.02
CR-1C 4765	P-OB-3	1-1/4 X 3	8.09
CR-1C 4785	P-OB-3	1-1/2 X 4	11.02
CR-1C 4786-A	P-OB-3	2 X 4	9.49
CR-1C 4796	P-OB-3	2-1/2 X 5	14.74
CR-1C 9964	P-U-5	2 X 4	38.76
CR-2C 1955	P-U-5	1-1/2 X 4	38.57
CR-2C 2842	P-OB-3	1-1/4 X 3	11.52
CR-2C 5395	P-U-5	3-1/2 X 6	63.14
CR-3C 2597	P-U-5	1-1/2 X 3	24.44
CR-3C 7684	P-OB-3	1-3/4 X 4	16.26

CROWN LIFT TRUCKS

Kit Number	Code (Pg. x)	Rod X Bore Size	List Price
CRN-101296	I-U-1	2-1/2" Rod Kit	\$ 14.17
CRN-101302	I-U-1	1-7/8 X 2-1/2	46.32
CRN-101305	I-U-1	1-5/8 X Rod Kit	67.98
CRN-101309	I-U-1	1-7/8" ROD KIT	48.60
CRN-101310	I-U-1	2-1/2" ROD KIT	18.69
CRN-101313	I-U-1	1-3/8" Rod Kit	17.84
CRN-101314	I-U-1	2-1/8" ROD KIT	13.78
CRN-101316	I-U-1	2-3/8" ROD KIT	32.18
CRN-101323	I-V-1	1-7/8" Rod Kit	44.24
CRN-101326	I-U-1	2-3/8" Rod Kit	21.84
CRN-101329	I-U-1	1-7/8", 2-5/8" 2 Stage	54.36
CRN-101331	I-U-1	1-3/4", 2-3/8" 2 Stage	43.60
CRN-101332	I-U-1	1-3/4 X 2-1/2	14.54

CROWN LIFT TRUCKS

Kit Number	Code (Pg. x)	Rod X Bore Size	List Price
CRN-101334	I-U-1	1-7/8, 2-5/8 Rod kit	\$ 53.37
CRN-101335	I-U-N	1-5/8", 2-1/4" 2 Stage	47.25
CRN-101336	I-U-1	1-5/8", 2-1/4" 2 Stage	48.05
CRN-101339	I-U-1	2" Rod Kit	48.04
CRN-101340	I-U-1	1-7/8 ROD KIT	14.84
CRN-101341	I-U-5	1-1/4 X 2-3/8	36.31
CRN-101342	I-U-3	1-1/2 X 3	36.58
CRN-101343	1-U-5	3/4 X 2	42.35
CRN-101346	I-U-5	3/4 X 1-3/4	30.27
CRN-101347	I-U-5	3/4 X 2-1/8	41.72
CRN-101376	I-U-5	1-1/4 X 3	40.07
CRN-101377	I-U-5	1 x 1-3/4	31.20
CRN-102659		VALVE KIT	3.37
CRN-105476004		O-RING	5.06
CRN-105476-6		O-RING	1.69
CRN-107366	I-O-1	1/2" Valve Kit	12.30
CRN-111573	I-U-1	3" ROD KIT	24.44
CRN-111574	I-U-1	2" ROD KIT	15.67
CRN-111790-001		O-RING	1.69
CRN-111790-12		O-RING	1.69
CRN-111790-2		O-RING	3.37
CRN-111790-3		O-RING	2.12
CRN-111790-4		O-RING	2.12
CRN-111790-9		O-RING	2.00
CRN-112022	I-U-4	7/8 X 2	14.34
CRN-112704		8, 9/16" Spools Rod Kit	13.11
CRN-113744	I-U-13	2-1/2 X 3-1/4	39.26
CRN-113745	I-U-13	3/4 x 1-3/4	18.96
CRN-115604	I-U-4	7/8 X 2	24.16
CRN-116360	N-O-1	o-ring	3.74
CRN-116820	I-U-1	2" rod kit	10.54
CRN-42249	I-U-1	56 X 80 mm	26.35
CRN-43023-1		VALVE KIT	21.61
CRN-78685		VALVE KIT	10.05
CRN-79017		VALVE KIT	3.10
CRN-87317	N-O-1	o-ring	2.75
CRN-87484		O-RING	2.87
CRN-88719		O-RING	2.57
CRN-89704	I-U-13	1-3/4 x 2-3/4	34.07
CRN-90880	I-U-5	3/4 X 1-3/4	31.44
CRN-93217		O-RING	2.75
CRN-94580	I-O-1	5/8" Rod kit	3.67

CUSTOM HOISTS 700 SERIES

CUSTOM HOISTS

- PACKING: Vee packing with nylon top and bottom adapters.
- WIPERS: An improved dual-lip snap in wiper to minimize contamination entry.
- Bearing: Top mineral filled nylon bearing.
- Retainer Ring: Heavy duty for improved strength.
- Plunger Stop: Beveled plunger stop for plunger center.
- Piston Wear Ring: Wear ring with increased cross-section for added strength.
- Stage O.D.'S: 3-3/16", 4-1/8", 5-1/16" & 6"
- Identification: Part number and serial number stamped in body near base of cylinder. Ex. 63-702-120

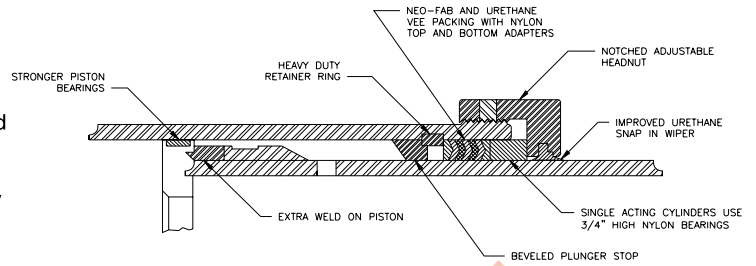

Part Number	Description	List Price
SEAL KITS		
CH-SK-53-700	3 - 5" Seal Kit	\$ 63.31
CH-SK-63-700	4 - 6" Seal Kit	72.45
CH-SK-64-700	3 - 6" Seal Kit	89.34
MINOR PACKING KITS		
CH-MPK-53-700	3 - 5" Minor Packing Kit	\$ 111.07
CH-MPK-63-700	4 - 6" Minor Packing Kit	121.38
CH-MPK-64-700	3 - 6" Minor Packing Kit	152.99
MAJOR PACKING KITS		
CH-MRK-53-700	3 - 5" Major Repair Kit	\$ 346.95
CH-MRK-63-700	4 - 6" Major Repair Kit	373.84
CH-MRK-64-700	3 - 6" Major Repair Kit	466.99
NYLON TOP BEARINGS		
CH-1BU11-3-3/16	3-3/16" Nylon Top Bearing	\$ 11.12
CH-1BU11-4-1/8	4-1/8" Nylon Top Bearing	11.48
CH-1BU11-5-1/16	5-1/16" Nylon Top Bearing	11.54
CH-1BU11-6	6" Nylon Top Bearing	8.89
PACKINGS		
CH-700-3-3/16VS	3-3/16" Vee Set	\$ 12.66
CH-700-4-1/8VS	4-1/8" Vee Set	14.71
CH-700-5-1/16VS	5-1/16" Vee Set	18.25
CH-700-6VS	6" Vee Set	15.45

Part Number	Description	List Price
WIPERS		
CH-1WR1-3-3/16	3-3/16" Wiper	\$ 3.71
CH-1WR1-4-1/8	4-1/8" Wiper	4.83
CH-1WR1-5-1/16	5-1/16" Wiper	5.95
CH-1WR1-6	6" Wiper	5.00
RETAINER RINGS		
CH-2RR58-368	3-11/16" Retainer Ring	\$ 36.73
CH-2RR58-462	4-5/8" Retainer Ring	36.73
CH-2RR58-550	5-1/2" Retainer Ring	38.56
CH-2RR58-650	6-1/2" Retainer Ring	38.74
PLUNGER STOP		
CH-2PS44-3-3/16	3-3/16" Plunger Stop	\$ 51.48
CH-2PS44-4-1/8	4-1/8" Plunger Stop	52.75
CH-2PS44-5-1/16	5-1/16" Plunger Stop	55.47
CH-2PS44-6	6" Plunger Stop	55.79
PISTON WEAR RINGS		
CH-2WG3-3-3/16	3-3/16" Piston Wear Ring	\$ 3.23
CH-2WG3-4-1/8	4-1/8" Piston Wear Ring	4.06
CH-2WG3-5-1/16	5-1/16" Piston Wear Ring	4.78
CH-2WG3-6	6" Piston Wear Ring	5.78



CUSTOM HOISTS 400 SERIES

PACKING:	Vee packing with nylon top and bottom adapters.
WIPERS:	An improved dual-lip snap in wiper to minimize contamination entry.
WAVE SPRING:	To apply a continuous force on the packing.
BEARINGS:	Top and bottom mineral filled nylon bearing.
RETAINER RING:	Heavy duty for improved strength.
PLUNGER STOP:	Beveled plunger stop for plunger centering.
PISTON WEAR RING:	Wear ring with increased cross-section for added strength.
STAGE O.D.'S:	3, 4, 5, 6, 7, 8, 8-1/4, 9-1/8, 9-3/4
IDENTIFICATION:	Part number and serial number stamped in body near oil port near base of cylinder. Example: 85-402-250 single acting.

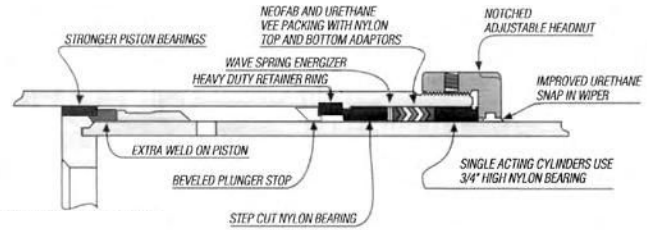

Part Number	Description	List Price
SEAL KITS		
CH-SK-53-400	3 - 5" Seal Kit	\$ 82.60
CH-SK-63-400	4 - 6" Seal Kit	99.41
CH-SK-64-400	3 - 6" Seal Kit	124.22
CH-SK-73-400	5 - 7" Seal Kit	130.35
CH-SK-74-400	4 - 7" Seal Kit	155.58
CH-SK-8-1/4 5-400	4 - 8-1/4" Seal Kit	269.45
CH-SK-84-400	5 - 8" Seal Kit	194.98
CH-SK-85-400	4 - 8" Seal Kit	220.45
CH-SK-95-400	5 - 9-1/8" Seal Kit	305.56
MINOR PACKING KITS		
CH-MPK-53-400	3 - 5" Minor Packing Kit	\$ 135.81
CH-MPK-63-400	4 - 6" Minor Packing Kit	155.69
CH-MPK-64-400	3 - 6" Minor Packing Kit	197.55
CH-MPK-73-400	5 - 7" Minor Packing Kit	191.55
CH-MPK-74-400	4 - 7" Minor Packing Kit	234.08
CH-MPK-8-1/4 5-400	4 - 8-1/4" Minor Packing Kit	417.04
CH-MPK-84-400	5 - 8" Minor Packing Kit	300.64
CH-MPK-85-400	4 - 8" Minor Packing Kit	323.94
CH-MPK-95-400	5 - 9" Minor Packing Kit	634.36
MAJOR REPAIR KITS		
CH-MRK-53-400	3 - 5" Major Repair Kit	\$ 407.07
CH-MRK-63-400	4 - 6" Major Repair Kit	427.13
CH-MRK-64-400	3 - 6" Major Repair Kit	559.09
CH-MRK-73-400	5 - 7" Major Repair Kit	460.43
CH-MRK-74-400	4 - 7" Major Repair Kit	595.90
CH-MRK-8-1/4 5-400	4 - 8" Major Repair Kit	1165.64
CH-MRK-84-400	5 - 8" Major Repair Kit	674.23
CH-MRK-85-400	4 - 8" Major Repair Kit	809.98
CH-MRK-95-400	5 - 9" Major Repair Kit	1272.19
PACKING & WIPERS		
CH-400-3VSW	3" Vee Set & Wiper	\$ 10.81
CH-400-4VSW	4" Vee Set & Wiper	15.35
CH-400-5VSW	5" Vee Set & Wiper	18.49
CH-400-6VSW	6" Vee Set & Wiper	22.92
CH-400-7VSW	7" Vee Set & Wiper	27.36
CH-400-8.25VSW	8-1/4" Vee Set & Wiper	76.22
CH-400-8VSW	8" Vee Set & Wiper	33.36
CH-400-9.12VSW	9-1/8" Vee Set & Wiper	94.84
NYLON BOTTOM BEARINGS		
CH-1BU195-3	3" Nylon Bottom Bearing	\$ 9.25
CH-1BU195-4	4" Nylon Bottom Bearing	9.50
CH-1BU195-5	5" Nylon Bottom Bearing	10.34
CH-1BU195-6	6" Nylon Bottom Bearing	11.12
CH-1BU195-7	7" Nylon Bottom Bearing	12.61
CH-1BU195-8	8" Nylon Bottom Bearing	14.78
CH-1BU195-825	8-1/4" Nylon Bottom Bearing	34.53
CH-1BU195-91	9-1/8" Nylon Bottom Bearing	22.53
NYLON TOP BEARINGS		
CH-1BU11-3	3" Nylon Top Bearing	\$ 7.14
CH-1BU11-4	4" Nylon Top Bearing	7.14

Part Number	Description	List Price
NYLON TOP BEARINGS		
CH-1BU11-5	5" Nylon Top Bearing	\$ 7.52
CH-1BU11-6	6" Nylon Top Bearing	8.89
CH-1BU11-7	7" Nylon Top Bearing	9.68
CH-1BU11-8	8" Nylon Top Bearing	11.72
CH-1BU11-82	8-1/4" Nylon Top Bearing	22.20
CH-1BU11-91	9-1/8" Nylon Top Bearing	27.30
RETAINER RINGS		
CH-2RR58-350	3-1/2" Retainer Ring	\$ 41.56
CH-2RR58-450	4-1/2" Retainer Ring	40.61
CH-2RR58-550	5-1/2" Retainer Ring	38.56
CH-2RR58-650	6-1/2" Retainer Ring	38.74
CH-2RR58-750	7-1/2" Retainer Ring	39.82
CH-2RR58-850	8-1/2" Retainer Ring	61.32
CH-2RR58-9	9" Retainer Ring	180.79
CH-2RR58-975	9-3/4" Retainer Ring	130.08
WAVE SPRINGS		
CH-1WA11-3	3" Wave Spring	\$ 10.88
CH-1WA11-4	4" Wave Spring	11.78
CH-1WA11-5	5" Wave Spring	13.09
CH-1WA11-6	6" Wave Spring	15.44
CH-1WA11-7	7" Wave Spring	25.05
CH-1WA11-8	8" Wave Spring	26.91
CH-1WA11-825	8-1/4" Wave Spring	28.42
CH-1WA11-91	9-1/8" Wave Spring	30.39
PLUNGER STOPS		
CH-2PS36-3	3" Plunger Stop	\$ 59.83
CH-2PS36-4	4" Plunger Stop	60.97
CH-2PS36-5	5" Plunger Stop	61.15
CH-2PS36-6	6" Plunger Stop	63.25
CH-2PS36-7	7" Plunger Stop	64.40
CH-2PS36-8	8" Plunger Stop	80.24
CH-2PS36-825	8-1/4" Plunger Stop	95.15
CH-2PS36-91	9-1/8" Plunger Stop	157.88
PISTON WEAR RINGS		
CH-2WG1-3	3" Piston Wear Ring	\$ 3.19
CH-2WG1-4	4" Piston Wear Ring	3.43
CH-2WG1-5	5" Piston Wear Ring	3.49
CH-2WG1-6	6" Piston Wear Ring	4.03
CH-2WG1-7	7" Piston Wear Ring	4.71
CH-2WG1-8	8" Piston Wear Ring	8.52
CH-2WG1-91	9-1/8" Piston Wear Ring	13.84
WIPERS		
CH-1WR1-3	3" WIPER	\$ 2.95
CH-1WR1-4	4" WIPER	3.53
CH-1WR1-5	5" WIPER	4.24
CH-1WR1-6	6" WIPER	5.00
CH-1WR1-7	7" WIPER	6.18
CH-1WR1-8	8" WIPER	7.30
CH-1WR1-825	8-1/4" WIPER	10.37
CH-1WR1-91	9.12" WIPER	15.02

CUSTOM HOISTS TELESCOPICS

- PACKING:** Vee packing with nylon top and bottom adaptors.
4" thru 8" all 1/4" c.s.
- WIPERS:** Snap in.
- BEARINGS:** One bronze or mineral filled nylon bearing above the packing.
- PISTON:** Steel pistons welded to stage. Replaceable "T" shaped nylon wear rings. Double action use 2 cast iron piston rings in separate grooves.
- STAGE O.D.'s:** 3, 4, 5, 6, 7, 8, 8-1/4, 9-1/8, 9-3/4
- SPECIAL INFO.:** Uses 2 spiral retainer rings with metal spacer in between.
- IDENTIFICATION:** Part number and serial number stamped in body near oil port near base of cylinder.
Example: 85-2-220 single acting;
DAT73-4-128 double acting

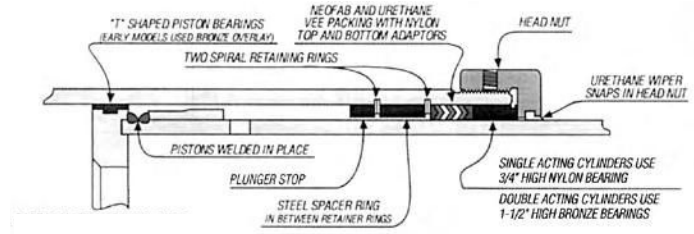

Part Number	Description	List Price
PACKING & WIPERS		
CH-3VSW	3" Vee Set & Wiper	\$ 10.45
CH-4VSW	4" Vee Set & Wiper	11.61
CH-5.87VSW	5-7/8" Vee Set & Wiper	20.72
CH-5VSW	5" Vee Set & Wiper	16.42
CH-6VSW	6" Vee Set & Wiper	20.02
CH-7VSW	7" Vee Set & Wiper	23.39
CH-8VSW	8" Vee Set & Wiper	26.36
CH-8.25VSW	8-1/4" Vee Set & Wiper	60.24
CH-9.12VSW	9-1/8" Vee Set & Wiper	87.06
CH-9.75VSW	9-3/4" Vee Set & Wiper	94.92
NYLON TOP BEARINGS		
CH-1BU11-3	3" Nylon Top Bearing	\$ 7.14
CH-1BU11-4	4" Nylon Top Bearing	7.14
CH-1BU11-5	5" Nylon Top Bearing	7.52
CH-1BU11-6	6" Nylon Top Bearing	8.89
CH-1BU11-7	7" Nylon Top Bearing	9.68
CH-1BU11-8	8" Nylon Top Bearing	11.72
CH-1BU11-82	8-1/4" Nylon Top Bearing	22.20
CH-1BU11-91	9-1/8" Nylon Top Bearing	27.30
CH-1BU1291/8	9-1/8" Nylon Top Bearing 1-1/2" Tall	54.98
BRONZE TOP BEARINGS		
CH-1BU3-3	3" X 3-1/2" X 1-1/2" Bronze Top Bearing	\$ 55.55
CH-1BU3-4	4" X 4-1/2" X 1-1/2" Bronze Top Bearing	76.99
CH-1BU3-5	5" X 5-1/2" X 1-1/2" Bronze Top Bearing	82.01
CH-1BU3-587	5-7/8" X 6-3/8" X 1-1/2" Bronze Top Bearing	79.38
CH-1BU3-6	6" X 6-1/2" X 1-1/2" Bronze Top Bearing	90.88
CH-1BU3-7	7" X 7-1/2" X 1-1/2" Bronze Top Bearing	104.47
CH-1BU3-8	8" X 8-1/2" X 1-1/2" Bronze Top Bearing	119.57
CH-1BU3-825	8-1/4" X 9" X 1-1/2" Bronze Top Bearing	119.19
CH-1BU3-975	9-3/4" X 10-1/2" X 1-1/2" Top Bearing	145.22
SPIRAL RETAINER RINGS		
CH-1RR1-35	3-1/2" Bore Spiral Retainer Ring	\$ 3.08
CH-1RR1-45	4-1/2" Bore Spiral Retainer Ring	7.34
CH-1RR1-55	5-1/2" Bore Spiral Retainer Ring	7.50
CH-1RR1-637	6-3/8" Bore Spiral Retainer Ring	56.93
CH-1RR1-65	6-1/2" Bore Spiral Retainer Ring	5.82
CH-1RR1-75	7-1/2" Bore Spiral Retainer Ring	7.69
CH-1RR1-85	8-1/2" Bore Spiral Retainer Ring	9.55
CH-1RR1-9	9" Bore Spiral Retainer Ring	39.47
CH-1RR1-97	9-3/4" Bore Spiral Retainer Ring	60.20
CH-1RR1-105	10-1/2" Bore Spiral Retainer Ring	80.24

Part Number	Description	List Price
SPACER RINGS		
CH-2SP1-3	3" Spacer	\$ 22.66
CH-2SP1-4	4" Spacer	34.53
CH-2SP1-5	5" Spacer	39.47
CH-2SP1-5-7/8	5-7/8" Spacer	79.62
CH-2SP1-6	6" Spacer	44.29
CH-2SP1-7	7" Spacer	55.12
CH-2SP1-8	8" Spacer	68.64
CH-2SP1-8.25	8-1/4" Spacer	307.45
CH-2SP1-9.12	9-1/8" Spacer	112.83
CH-2SP1-9.75	9-3/4" Spacer	74.50
PISTON WEAR RINGS		
CH-2GR6-3	3" Piston Wear Ring	\$ 5.10
CH-2GR6-4	4" Piston Wear Ring	5.50
CH-2GR6-5	5" Piston Wear Ring	7.02
CH-2GR6-587	5-7/8" Piston Wear Ring	8.71
CH-2GR6-6	6" Piston Wear Ring	8.71
CH-2GR6-7	7" Piston Wear Ring	9.47
CH-2GR6-8	8" Piston Wear Ring	15.62
CH-2GR6-825	8-1/4" Piston Wear Ring	22.32
CH-2GR6-91	9-1/8" Piston Wear Ring	22.32
CH-2GR6-975	9-3/4" Piston Wear Ring	23.43
CH-2WG1-3	3" Piston Wear Ring	3.19
CH-2WG1-4	4" Piston Wear Ring	3.43
CH-2WG1-5	5" Piston Wear Ring	3.49
CH-2WG1-6	6" Piston Wear Ring	4.03
CH-2WG1-7	7" Piston Wear Ring	4.71
CH-2WG1-8	8" Piston Wear Ring	8.52
CH-2WG1-91	9-1/8" Piston Wear Ring	13.84
PISTON RINGS (DOUBLE ACTING)		
CH-2PR3-35	3-1/2" Piston Ring	\$ 8.16
CH-2PR3-45	4-1/2" Piston Ring	10.22
CH-2PR3-55	5-1/2" Piston Ring	13.12
CH-2PR3-637	6-3/8" Piston Ring	65.65
CH-2PR3-65	6-1/2" Piston Ring	21.25
CH-2PR3-75	7-1/2" Piston Ring	19.94
CH-2PR3-85	8-1/2" Piston Ring	26.87
CH-2PR3-97	9-3/4" Piston Ring	55.31
CH-2PR3-105	10-1/2" Piston Ring	71.77

CUSTOM HOISTS TELESCOPICS

Part Number	Description	List Price
KITS		
CH-35	3" - 5" Vee Set & Wiper	\$ 38.53
CH-46	4" - 6" Vee Set & Wiper	48.06
CH-47	4" - 7" Vee Set & Wiper	71.47
CH-48	4" - 8" Vee Set & Wiper	97.82
CH-48-1/4	4" - 8 -1/4" Vee Set & Wiper	131.72
CH-49	4" - 9 -1/8" Vee Set & Wiper	184.87
CH-57	5" - 7" Vee Set & Wiper	59.83
CH-58	5" - 8" Vee Set & Wiper	86.20
CH-59	5" - 9-1/8" Vee Set & Wiper	173.25
CH-NPB35	3" - 5" Nylon Piston Wear Rlng Kit	17.63
CH-NPB36	3" - 6" Nylon Piston Wear Ring Kit	26.34
CH-NPB46	4" - 6" Nylon Piston Wear Ring Kit	21.23
CH-NPB47	4" - 7" Nylon Piston Wear Ring Kit	30.70
CH-NPB48	4" - 8" Nylon Piston Wear Rlng Kit	46.32
CH-NPB48-1/4	4"- 8-1/4" Nylon Piston Wear Ring Kit	53.02
CH-NPB49	4" - 9-1/8" Nylon Piston Wear Ring	68.64
CH-NPB57	5" - 7" Piston Wear Ring Kit	25.20
CH-NPB58	5" - 8" Piston Wear Ring Kit	40.80
CH-NPB59	5" - 9-1/8" Piston Wear Ring Kit	63.13
CH-NYB35-DA	2 ea. 3" - 5" Nylon Top Bearings	43.63
CH-NYB35-SA	1 ea. 3" - 5" Nylon Top Bearings	21.81
CH-NYB36-DA	2 ea. 3" - 6" Nylon Top Bearings	61.44
CH-NYB36-SA	1 ea. 3" - 6" Nylon Top Bearings	30.72
CH-NYB46-DA	2 ea. 4" - 6" Nylon Top Bearings	47.12
CH-NYB46-SA	1 ea. 4" - 6" Nylon Top Bearings	23.56
CH-NYB47-DA	2 ea. 4" - 7" Nylon Top Bearings	66.47
CH-NYB47-SA	1 ea. 4" - 7" Nylon Top Bearings	33.23
CH-NYB48-1/4	1 ea. 4" - 8-1/4" Nylon Top Bearings	55.44
CH-NYB48-DA	2 ea. 4" - 8" Nylon Top Bearings	89.90
CH-NYB48-SA	1 ea. 4" - 8" Nylon Top Bearings	44.94
CH-NYB49-DA	2 ea. 4" - 8" Nylon Top Bearing & 1 ea. 9-1/8" Nylon Top Bearings	157.55
CH-NYB57-DA	2 ea. 5" - 7" Nylon Top Bearings	52.17
CH-NYB57-SA	1 ea. 5" - 7" Nylon Top Bearings	26.08
CH-NYB58-DA	2 ea. 5" - 8" Nylon Top Bearings	75.59
CH-NYB58-SA	1 ea. 5" - 8" Nylon Top Bearings	37.79
CH-NYB59-DA	2 ea. 5" - 9-1/8" Nylon Top Bearings	148.95
CH-NYB59-SA	1 ea. 5" - 9" Nylon Top Bearings	74.48
CH-PR35	2 ea. 3-1/2" - 5-1/2" Piston Rings	63.96
CH-PR36	2 ea. 3-1/2" - 6-1/2" Piston Rings	106.48
CH-PR46	2 ea. 4-1/2" - 6-1/2" Piston Rings	89.20
CH-PR47	2 ea. 4-1/2" - 7-1/2" Piston Rings	129.08
CH-PR48	2 ea. 4-1/2" - 8-1/2" Piston Rings	182.81
CH-PR49	2 ea. 4-1/2" - 9-3/4" Piston Rings	293.44
CH-PR57	2 ea. 5-1/2" - 7-1/2" Piston Rings	108.64
CH-PR58	2 ea. 5-1/2" - 8-1/2" Piston Rings	162.37

Part Number	Description	List Price
KITS		
CH-PR59	2 ea. 5-1/2" - 9-3/4" Piston Rings	\$ 273.00
CH-PS1-3	3" Plunger Stop	29.23
CH-PS1-4	4" Plunger Stop	33.11
CH-PS1-5	5" Plunger Stop	38.12
CH-PS1-587	5-7/8" Plunger Stop	83.32
CH-PS1-6	6" Plunger Stop	39.11
CH-PS1-7	7" Plunger Stop	40.28
CH-PS1-8	8" Plunger Stop	43.46
CH-PS1-82	8-1/4" Plunger Stop	76.29
CH-PS1-91	9-1/8" Plunger Stop	83.49
CH-PS1-975	9-3/4" Plunger Stop	85.75
CH-SR35	2 ea. 3-1/2" - 5-1/2" Spiral Retainer	34.21
CH-SR36	2 ea. 3-1/2" - 6-1/2" Spiral Retainer	45.50
CH-SR46	2 ea. 4-1/2" - 6-1/2" Spiral Retainer	41.30
CH-SR47	2 ea. 4-1/2" - 7-1/2" Spiral Retainer	56.68
CH-SR48	2 ea. 4-1/2" - 8-1/2" Spiral Retainer	75.77
CH-SR48-1/4	2 ea. 4-1/2" - 9" Spiral Retainer	218.01
CH-SR49	2 ea. 4-1/2" - 9-3/4" Spiral Retainer	196.17
CH-SR57	2 ea. 5-1/2" - 7-1/2" Spiral Retainer	42.02
CH-SR58	2 ea. 5-1/2" - 8-1/2" Spiral Retainer	61.11
CH-SR59	2 ea. 5-1/2" - 9-3/4" Spiral Retainer	181.51
HEAD NUTS (Measured at thread - have 12th/in)		
CH-2HN-4	4" Head Nut	\$ 59.78
CH-2HN-5	5" Head Nut	61.48
CH-2HN-6	6" Head Nut	81.34
CH-2HN-7	7" Head Nut	84.80
CH-2HN-8	8" Head Nut	102.04
CH-2HN-82	8-1/4" Head Nut	213.64
CH-2HN-9	9" Head Nut	139.93
CH-2HN-10	10" Head Nut	206.15
CH-2HN-106	10-3/8" Head Nut	229.30
CH-3HN1-11.25	11-1/4" Head Nut (over 9-3/4" Stage)	414.12
CH-3HN1-9.75	9-3/4" Head Nut (over 8-1/4" Stage)	307.80
MISCELLANEOUS PARTS		
CH-ABVA-1	Automatic Bleeder	\$ 39.72
CH-MBVA-1	Manual Bleeder valve	2.53
CH-MBVA-3	OEM Style Manual Bleeder Valve	24.94
CH-SL-2-1	Nylon Slug	.46
CH-SS-3-1	Set Screw	.92
MAJOR REPAIR KITS (SINGLE ACTING)		
Kits include: Packing, wipers, nylon bushings, snap rings, piston bearing, set screws and nylon slugs.		
CH-MRK-63	4" - 6"	\$136.23
CH-MRK-74	4" - 7"	194.40
CH-MRK-84	5" - 8"	220.65
CH-MRK-85	4" - 8"	265.98
CH-MRK-95	5" - 9-1/8"	507.03



CUSTOM HOISTS PISTON-ROD CYLINDERS

Kit Number	Cylinder Number	Code (Pg. x)	RodXBore Size	List Price	Kit Number	Cylinder Number	Code (Pg. x)	RodXBore Size	List Price
CH-SK-4-1/2-15	DA4-1/2-44-21	I-V-5	3 X 4-1/2	\$ 35.15	CH-SK-6-31	DA6-40-108	I-U-12	4-1/2 X 6	\$ 79.83
CH-SK-4-1/2-6	DA4-1/2-21	I-U-11	2 X 4-1/2	43.60	CH-SK-6-33		I-U-1	4" Rod Kit	14.95
CH-SK-4-1/2-8	DA4-1/2-41-48-5/8	P-U-12	2 X 4-1/2	67.63	CH-SK-6-34	DA6-100-63	I-V-10	4 X 6	58.66
CH-SK-4-13	DA4-126-28	I-U-5	2-3/4 X 4	30.15	CH-SK-6-42	DA6-188-60,	I-V-5	4 X 6	44.47
CH-SK-4-19	SA4-11-25	I-V-1	4" Rod Kit	19.61	CH-SK-6-44	DA6-203-42	I-V-5	2-3/4 X 6	56.47
CH-SK-4-21	DA4-142-21-1/2	I-V-10	2-1/2 X 4	25.51	CH-SK-6-54	DA6-9-70-1/2, DA6-9-60-1/2	I-V-10	4 X 6	69.60
CH-SK-4-23	DA4-171-27-3/4	I-V-10,12	2-3/4 X 4	28.65	CH-SK-6-6	DA6-47-47	P-V-5	4 X 6	46.38
CH-SK-4-4	DA4-77-14	I-V-5	1-3/4 X 4	25.64	CH-SK-6-8	DA6-68-79	I-U-5	4 X 6	45.64
CH-SK-4-5	DA4-107-24	I-U-5	2-1/2 X 4	30.31	CH-SK-7-1	DA7-5	I-U-12	5-1/2 X 7	114.75
CH-SK-4-6	DA4-104-48	I-U-5	2 X 4	31.10	CH-SK-7-16	DA7-4-23	I-V-5	3 X 7	52.22
CH-SK-5-1	DA5-67-14	I-U-5	2 X 5	29.97	CH-SK-7-17	DA7-78-79	I-V-5	4 X 7	54.52
CH-SK-5-12	DA5-144-36	I-V-11,12	2-1/2 X 5	66.14	CH-SK-7-18	DA-7-29	I-U-10	5-1/2 X 7	85.15
CH-SK-5-13	DA5-47-27	I-V-5	3 X 5	52.58	CH-SK-7-20	DA7-36-78, DA7- 49-88	I-U-12	4-1/2 X 7	79.11
CH-SK-5-21	DA5-130-16	I-V-5	2-1/2 X 5	48.86	CH-SK-7-34		I-V-4, 12	2-1/2 X 7	77.79
CH-SK-5-28	DA5-41-19,20,23	I-V-5	3 X 5	49.67	CH-SK-7-35	DA7-121,78,83 or 55	I-U-10	4-1/2 X 7	73.52
CH-SK-5-35	DA5-4-26	I-V-9	2-1/2 X 5	41.64	CH-SK-7-43		I-U-4	2 X 7	33.25
CH-SK-6-1	DA6-60, DA6-90, DA6-88	I-V-1	4-1/2 X 6	23.62	CH-SK-7-5	DA7-36-115	I-U-12	4-1/2 X 7	82.37
CH-SK-6-11	DA6-39-78	I-V-5	4-1/2 X 6	91.21	CH-SK-7-9	DA7-63	I-U-10	4-1/2 X 7	86.28
CH-SK-6-15		I-V-5	3-1/2 X 6	87.04	CH-SK-8-1		I-V-4	3 X 8	64.81
CH-SK-6-2	DA6-39-78,	I-U-12	4-1/2 X 6	66.29	CH-SK-8-21	DA8-16-25	I-V-12	2-1/2 X 8	72.81
CH-SK-6-22	DA6-140	I-V-5	4 x 6	45.57	CH-SK-8-3		I-U-5	3 X 8	70.91
CH-SK-6-23	DA6-92-46,62,68	I-V-12	4-1/2 X 6	69.00	CH-SK-9-2	DA9-19-19	I-V-5	3-1/2 X 9	132.63
CH-SK-6-26	DA6-73-34	I-V-5	2-1/2 X 6	41.24	CH-SK-42-60	42-60-43 or CH-475 3"-4" Vee Set & Wiper Telescopic			23.37
CH-SK-6-29	DA6-158-42	I-U-5	2-3/4 X 6	55.35					
CH-SK-6-30	DA6-49-78	I-U-12	4 X 6	62.99					



KINGSEAL CO., LTD. THAILAND

46/152-153 Moo 3 Sri Saman Road
Baan Mai Pakkret, Nonthaburi Thailand 11120

Tel: +662 9617534 to 6

Fax: +662 9617540

Email: intlsales@kingseal.co.th / kingsealmail@gmail.com

Website: <http://www.kingseal.co.th>

DEMPSTER REFUSE TRUCKS

Kit Number	Cylinder Number	Code (Pg. x)	RodXBore Size	List Price
DD-350U	BB7053	P-U-5	2 X 3-1/2	\$ 31.62
DD-400V	CB3267, CB3574, CB3805	I-V-9	2 X 4	86.24
DD-401U	BB6579, 6581,	P-U-5	2 X 4	30.33
DD-500V	CB3248	I-V-9	2-1/2 X 5	106.18
DD-501U	BB6451	P-U-5	2-1/2 X 5	35.81
DD-520U	BB8000	P-U-5	2 X 5	36.27
DD-5470K	CB5470	I-V-1	3 X 3-1/2	16.72
DD-5937K	BB5937	I-V-9	2 X 5	85.80
DD-5938K	BB5938	I-V-9	3 X 5	94.81
DD-6888K	BB6888, BB8281	P-N-1	2-1/2 X 3-1/2	21.23
DD-6996K	BB6996, BB8010	P-U-5	3 X 5	40.96
DD-6997K	BB6997	P-U-5	2 X 5	37.08
DD-8112K	BB8112	P-U-5	2-1/2 X 6	58.31
DD-8133K	BB8133	P-V-5	2-1/2 X 6	60.64
DD-8134K	BB8134	P-V-5	3 X 5	45.66
DD-8169K	BB8169	P-V-5	2 X 4	34.93
DD-8185K		P-V-5	2 X 5	37.77
DD-8206K		P-V-5	3 X 6	57.54
DD-8235K		P-U-5	3 X 5	49.29
DD-HA 2557	AB12308	N-OB-3	1-1/8 X 2-1/2	5.26
DD-HA 2561	AB12225	P-OB-3	1-1/8 X 2-1/2	12.51
DD-HA 2629	PI100-20	I-OB-3	1-1/2 X 3	10.21
DD-HA 2630	PI100-21	I-U-5	1-1/2 X 3-1/2	20.82
DD-HA 2632		I-U-4,12	4 X 4-1/2	41.80
DD-HA 2633		I-U-1	3" ROD	9.69
DD-HA 2634	PI100-94, CB10006	I-OB-3	1-1/2 X 2-1/2	9.13
DD-HA 2895	AB13978	I-OB-3	1-1/2 X 2-1/2	10.60
DD-HA 3300	BB8379-1, BB8748-1, BB8750-1	I-V-5	2 X 4	32.47
DD-HA 3301	BB6888, BB8281-1	I-N-4	2-1/2 X 3-1/2	11.80
DD-HA 3302	BB8133-1	I-V-5	2-1/2 X 6	52.81
DD-HA 3303	BB8374-1, BB8185-1	I-V-5	2 X 5	42.28
DD-HA 3304	BB8134-1	I-V-5	3 X 5	45.13
DD-HA 3527	AB19461, AB19462CH	I-V-9	3 X 6	59.61
DD-HA 3541	AB19775TH	I-V-5,12	2 X 5	51.26
DD-HA 3542	AB19774TH	I-V-5,12	2 X 4	45.33
DD-HA 3557	AB19602TH	I-N-4	2-1/2 X 3-1/2	16.09
DD-HA 3558	AB19601TH	I-V-5	3 X 5	45.26
DD-HA 3559	AB19600TH	I-V-5	2-1/2 X 6	66.88
DD-HA 3562	AB19869TH	I-V-5	2 X 4	36.29
DD-HA 3563	AB19890TH	I-V-5	2 X 5	42.34

Kit Number	Cylinder Number	Code (Pg. x)	RodXBore Size	List Price
DD-HA 3775		I-U-5	1-3/4 X 4	\$ 29.09
DD-HA 3799		I-U-13	2-1/2 X 3-1/2	23.24
DD-HA 3809		I-U-10,12	2 X 4	48.43
DD-HA 3868		I-U-10,12	2-1/2 X 4-1/2	65.97
DD-HA 3869		I-U-4	1-1/4 X 2	13.03
DD-HA 4166		I-U-10,12	2-1/2 X 5	49.51
DD-HA 4263		I-U-1	3-1/2 X 4	24.38
DD-HA 4264		I-U-10	3 X 5	28.62
DD-HA 4265		I-U-10	2-1/2 X 6	33.05
DD-HA 4380		I-U-12	2 X 4	36.92
DD-HA 4387		I-U-10	2-1/2 X 4	60.29
DD-HA 4444		I-U-10	2" X 4"	42.32
DD-HYO 49	O-Ring Kit for 6 Stage Hyco 4"-9"			13.62
DD-PK00107	DB07208, AB26635	P-V-5	2-1/2 X 6	49.89

DENSMORE

Kit Number	Code (Pg. x)	Rod X Bore Size	List Price
DN501220767A	I-U-3	1-1/4 X 5	\$ 27.58
DN6012272438	I-U-3	1-1/4 X 6	35.86
DN6014304312	I-U-3	1-1/2 X 6	27.92
DN6020304312	I-U-3	2 X 6	33.82
DN7014273372	I-U-3	1-1/2 X 7	43.61
DN7020303312	I-U-3	2 X 7	41.50

DRILTECH

Kit Number	Code (Pg. x)	Rod X Bore Size	List Price
DT-1027-088	I-V-9	2-1/2 X 5	\$ 83.54
DT-1029-085	I-V-9	3 X 4-1/2	101.41
DT-12471-058	I-V-9	3-3/4 X 5	211.10
DT-1974-065	I-V-9	3 X 5	135.60
DT-3130-077	I-V-9	3 X 5	86.75

DYNAHOE

Kit Number	Code (Pg. x)	Rod X Bore Size	List Price
DH-116613	P-U-10	3 X 6	\$ 53.61
DH-116840	P-U-10	2-1/2 X 4	35.00

EATON-YALE, TIMBERJACK

Kit Number	Code (Pg. x)	Rod X Bore Size	List Price
EY-2106793	P-U-10	1-1/2 X 3	\$ 26.43
EY-6955800	I-U-10	2 X 3-1/2	33.10
EY-6955804	I-U-10	2-1/4 X 5	51.47
EY-6955805	I-U-10	2-1/2 X 5-1/2	53.04

EDBRO

Kit Number	Bore	Lip Hgt.	Thick-ness	Hole Size	List Price
9200-062ED	2	7/8	7/32	5/8	\$ 9.01
9262-087ED	2-5/8	7/8	7/32	7/8	16.60
9325-100ED	3-1/4	7/8	7/32	1	17.90
9387-112ED	3-7/8	7/8	7/32	1-1/8	20.45
9475-125ED	4-3/4	7/8	7/32	1-1/4	24.61
9575-150ED	5-3/4	7/8	7/32	1-1/2	29.21

EFFER CRANES

Kit Number	Code (Pg. x)	Rod X Bore Size	List Price
EF-2160990	I-U-15	100 X 140 mm	\$ 57.05
EF-2166980	I-U-15	35 X 50 mm	29.68
EF-2261990	I-U-15	130 X 220 mm	100.02
EF-2565990	I-U-15	70 X 90 mm	36.63
EF-2663990	I-U-15	65, 125, X 95, 150 mm	91.69
EF-2761990	I-U-15	110 X 150 mm	76.68
EF-3461990	I-U-15	90 X 130 mm	56.71
EF-3760990	I-U-15	120 X 170 mm	71.55
EF-3761990	I-U-15	90 X 130 mm	56.71
EF-3764990	N-N-15	130 mm PISTON	51.94
EF-3861990	I-U-15	65 X 100 mm	41.87
EF-4464990	N-N-15	130 mm PISTON	90.10
EF-4469990	I-U-15	35,75,120 X 55,90,135mm	115.24
EF-8086500	N-N-15	95, 150 PISTONS	92.50
EF-8087300	N-N-15	130 mm PISTON	29.15

ENERGY

Kit Number	Code (Pg. x)	Rod X Bore Size	List Price
EN-12621X	I-U-3	2 X 4	\$ 31.01
EN-A2430	P-OB-3	1-1/8 X 2	6.28
EN-A2859	P-U-3	1-1/4 X 3	11.43
EN-A7564	P-U-3	1-1/2 X 4	16.47

ESCO

Kit Number	Code (Pg. x)	Rod X Bore Size	List Price
ES-402965	O-Rings		\$ 3.15
ES-402968	O-Rings/Back-Ups		6.13
ES-402970	O-Rings/Back-Ups		2.95
ES-4046426	I-U-5,10	2-1/2 X 5	73.95
ES-4049054	TRW Motor Kit		51.20
ES-4050756	I-U-10	2-1/4 X 4	25.32
ES-4095570	I-U-10	2-1/4 X 4	25.32
ES-420885	I-U-5	1-1/2 X 3-1/2	16.45
ES-421446	I, P-U-5	2 X 4	20.15
ES-421461	I, P-U-5	2 X 5	52.81
ES-421479	P-U-5	2 X 6	57.88
ES-422204	I, P-U-5	2 X 3-1/2	34.80
ES-434043	I-U-10	2-1/2 X 5	24.30
ES-434837	I-U-4	2-1/2 X 4	28.65
ES-435261	I-U-5	1-1/2 X 3-1/2 Boom Cyl.	30.27
ES-435398	I-U-10	2 X 4	19.11
ES-435430	I-U-10	2 X 4	22.82
ES-435686	I-U-5,10	2-1/2 X 5	73.98
ES-435942	I-U-10	2-1/4 X 4	24.24

EUCLID TRUCKS

Kit Number	Description	List Price
EUC-12977806	4", 6.5", 8.5" Stage Telescopic	\$ 357.10
EUC-4046574	6-1/4, 7, 8-1/4, 9, 10-1/2, 11	668.11
EUC-603323	4", 6", 8" Stages	300.85
EUC-R22HOIST	4", 6-1/2", 8-1/2" Stages	125.77
EUC-R50HOIST	3", 6", 8" Stages	125.20

FASSI-CRANE

Kit Number	Code (Pg. x)	Rod X Bore Size	List Price
FAS-GSC-116	I-U-15	95 X 140 mm	\$ 97.14
FAS-GSC-125	I-U-15	95 X 140 mm	97.14
FAS-GSC-138	I-U-15	50 X 75 mm	42.95
FAS-GSC-140	I-U-1	30 mm Rod Kit	17.98
FAS-GSC-152		O-Ring Kit	4.77
FAS-GSC-156	I-U-15	2 Stage 60, 95 mm	123.68
FAS-GSC-157	I-U-15	95 X 100 mm	92.62
FAS-GSC-158	I-U-15	60 X 90 mm	100.17
FAS-GSC-161	I-U-15	35 X 60 mm	22.85
FAS-GSC-162	I-U-15	2 Stage 35, 70 mm	66.67
FAS-GSC-202	N-N-15	130 mm Rod Kit	50.22
FAS-GSC-203	I-U-15	100 X 170 mm	56.71
FAS-GSC-21	I-U-1	25 mm Rod Kit	15.16
FAS-GSC-217	N-N-15	150 mm Piston Kit	58.83
FAS-GSC-228	I-U-15	55 X 95 mm	31.01
FAS-GSC-23	N-N-15	110 mm Piston Kit	79.77
FAS-GSC-245	I-U-15	55 X 85 mm	36.57
FAS-GSC-277	I-U-15	45 X 70 mm	35.85
FAS-GSC-279	I-U-15	55 X 85 mm	39.81
FAS-GSC-288	I-U-15	120 x 190 mm	92.16
FAS-GSC-33	N-N-15	160 mm Bore	24.90
FAS-GSC-35	N-N-15	80 mm Piston Kit	20.73
FAS-GSC-36	N-N-15	95 mm Piston Kit	29.40
FAS-GSC-56	I-U-15	80 X 95 mm	40.28
FAS-GSC-57	I-U-15	70 X 80 mm	23.79
FAS-GSC-62	I-U-15	80 X 95 mm	37.23

FIAT-ALLIS

Kit Number	Code (Pg. x)	Rod X Bore Size	List Price
FA-790458-11-1	P-U-13	70 X 125mm	\$ 129.11

FMC

Kit Number	Code (Pg. x)	Rod X Bore Size	List Price
FMC-232-7178-090	N-U,V-3	5/8 X 1-1/2	\$ 19.29
FMC-238-0858-090	P-V-7	2-1/2 X 5	63.20
FMC-238-4389-090	I-U-10	2-1/2 X 5	23.20
FMC-238-4529-090	P-V-7	1-1/2 X 4	39.57
FMC-239-4563-091			2.97
FMC-239-5241-090	I-V-N	7-1/4 ROD KIT	80.42
FMC-239-8317-090	I-V-5	1 X 2	28.50
FMC-360-4-0006	I-V-N	4-1/2 X 5	37.16
FMC-3X0094	P-U-10	1-1/2 X 3	17.55
FMC-507065	I-U-10	1-1/4 X 3	17.77

FMC

Kit Number	Code (Pg. x)	Rod X Bore Size	List Price
FMC-514-0246-090	I-U-4	2-1/2 X 5	\$ 31.46
FMC-514-0247-090	I-U-5	2-1/2 X 5	36.71
FMC-514-0844-090	I-U-1	2-1/2 X 3-1/2	25.32
FMC-514-0856-090	I-V-1	4-1/2 ROD KIT	19.36
FMC-514-1536-090	I-U-4	1-1/2 X 3-1/2	30.48
FMC-515-4130-090	I-V-5	2-1/2 X 5	47.23
FMC-515-6322-090	I-V-1	4-1/2 ROD KIT	28.22
FMC-515-8903-090	I-U-10	1-1/8 X 2-1/2	19.24
FMC-517-2118	P-U-5	1-1/4 X 3	34.02
FMC-517-2880	P-OB-3	1-1/4 X 3	8.60
FMC-519-9547-090	N-N-5	8" PISTON KIT	80.07
FMC-519-9548-090	P-U-10	3-1/2 X 6	36.71
FMC-519-9887-090	I-U-11	1-1/4 X 3	24.42
FMC-620-0104-090	I-U-11	3/4 X 1-1/2	10.82
FMC-620-0188-090	I-U-4	3 X 5	56.46
FMC-620-0190-090	I-U-4	2 X 3-1/2	29.37
FMC-620-0236-090	I-U-5	2 X 3-1/2	35.13
FMC-620-0307-090	I-U-11	1/2 X 1	15.90
FMC-620-0736-090	I-U-11	1-1/4 X 2	11.37
FMC-620-1545-090	I-U-5	3 X 4	75.53
FMC-620-1571-090	I-U-1	2-1/2 X 3	13.01
FMC-621-5638-090	I-U-10	3/4 X 1-1/2	72.83
FMC-621-5639-090	I-U-10	3/4 X 1-1/2	9.21
FMC-621-5641-090	I-U-1	2-1/2 ROD KIT	28.95
FMC-621-5644-090	I-U-10	3 X 5	53.14
FMC-621-5645-090	I-U-10	2 X 3-1/2	43.13
FMC-621-5646-090	I-U-10	2 X 3-1/2	43.13
FMC-621-5658	O-RING KIT		3.37

FONTAINE

Kit Number	Description	List Price
FNT-38	3" - 8" Vee Sets & Wipers	\$ 115.67
FNT-3VSW	3" Vee Set & Wiper	12.72
FNT-46	4" - 6" Vee Sets & Wipers	51.55
FNT-48	4" - 8" Vee Sets & Wipers	102.94
FNT-4VSW	4" Vee Set & Wiper	14.34
FNT-58	5" - 8" Vee Sets & Wipers	88.59
FNT-5VSW	5" Vee Set & Wiper	17.50
FNT-6VSW	6" Vee Set & Wiper	19.71
FNT-7VSW	7" Vee Set & Wiper	22.94
FNT-8VSW	8" Vee Set & Wiper	28.46

Replacement Kits For

FORD**FORD**

Loader Backhoes								
APPLICATION	CYL #	Piston Type	SERIAL #	CODE	ROD	BORE	KIT #	List \$
MODEL 340, 540								
BACKHOE BUCKET	D8NN-B576-FB	2pc	78/9-81	P-UV-9	63 mm	90 mm	FD-251032	109.49
	D8NN-B576-FB	1pc	78/9-81	P-UV-10	63 mm	90 mm	FD-251321	74.00
BACKHOE CROWD	D8NN-B578-AA	2pc	78/9-81	P-V-9	50 mm	100 mm	FD-251035	157.42
	D8NN-B578-AA	1pc	78/9-81	P-SP-10	50 mm	100 mm	FD-251316	106.05
	D8NN-B578-CC	1pc	78/9-81	P-UV-10	63 mm	115 mm	FD-251319	82.40
BACKHOE LIFT	D8NN-B578-CC	2pc	78/9-81	P-UV-9	63 mm	115 mm	FD-251036	93.66
	D8NN-B577-BB	2pc	78/9-81	P-UV-9	56 mm	115 mm	FD-251034	102.17
	D8NN-B577-BB	1pc	78/9-81	P-UV-10	56 mm	115 mm	FD-251318	78.57
BACKHOE STABILIZER	D8NN-B577-CB	1pc	78/9-81	P-SP-10	50 mm	100 mm	FD-251316	106.05
	D8NN-B577-CB	2pc	78/9-81	P-V-9	50 mm	100 mm	FD-251035	157.42
BACKHOE SWING	D8NN-B580-AA	2pc to 1pc	78/9-81	P-SP-10	50 mm	100 mm	FD-251339	70.53
	D8NN-B580-AA	2pc	78/9-81	P-UV-8	50 mm	100 mm	FD-251038	56.90
BACKHOE SWING	D8NN-B579-BE		78/9-81	P-UV-9	56 mm	110 mm	FD-251037	106.80
LOADER BUCKET	D8NN-L903-FC		3-81/9-81	P-U-10	35 mm	60 mm	FD-251369	26.61
LOADER LIFT	D8NN-L905-FD		3-81/9-81	P-SP-10	40 mm	60 mm	FD-251370	29.89
MODEL 340A, 540A								
BACKHOE BUCKET	D8NN-B576-EC	1pc	84/5-85	P-UV-10	63 mm	90 mm	FD-251321	74.00
	D8NN-B576-FB	1pc	10-81/5-85	P-UV-10	63 mm	90 mm	FD-251321	74.00
BACKHOE CROWD	D8NN-B578-AA	1pc	10-81/5-85	P-SP-10	50 mm	100 mm	FD-251316	106.05
	D8NN-B578-AB	1pc	82/5-85	P-SP-10	50 mm	100 mm	FD-251316	106.05
BACKHOE LIFT	D8NN-B578-CC	1pc	10-81/5-85	P-UV-10	63 mm	115 mm	FD-251319	82.40
	D8NN-B577-BB	1pc	10-81/5-85	P-UV-10	56 mm	115 mm	FD-251318	78.57
BACKHOE STABILIZER	D8NN-B577-CB	1pc	10-81/5-85	P-SP-10	50 mm	100 mm	FD-251316	106.05
	D8NN-B580-AA	2pc to 1pc	10-81/1-83	P-SP-10	50 mm	100 mm	FD-251339	70.53
	D8NN-B580-AA	2pc	10-81/1-83	P-UV-8	50 mm	100 mm	FD-251038	56.90
BACKHOE SWING	D8NN-B580-AD	1pc	2-83/5-85	P-UV-10	56 mm	100 mm	FD-251315	47.17
	D8NN-B579-BE		10-81/8-82	P-UV-9	56 mm	110 mm	FD-251037	106.80
	E0NN-B579-BB		9-82/5-85	P-UV-10	50 mm	110 mm	FD-251303	76.64
LOADER BUCKET	D8NN-L903-FC		10-81/5-85	P-U-10	35 mm	60 mm	FD-251369	26.61
LOADER LIFT	D8NN-L905-FD		10-81/5-85	P-SP-10	40 mm	60 mm	FD-251370	29.89
MODEL 340B, 540B								
BACKHOE BUCKET	D8NN-B576-EC	1pc	6-85/11-88	P-UV-10	63 mm	90 mm	FD-251321	74.00
	D8NN-B576-FB	1pc	6-85/11-88	P-UV-10	63 mm	90 mm	FD-251321	74.00
BACKHOE CROWD	D8NN-B578-AA	1pc	6-85/11-88	P-SP-10	50 mm	100 mm	FD-251316	106.05
	D8NN-B578-AB	1pc	6-85/11-88	P-SP-10	50 mm	100 mm	FD-251316	106.05
BACKHOE LIFT	D8NN-B578-CC	1pc	6-85/11-88	P-UV-10	63 mm	115 mm	FD-251319	82.40
	D8NN-B577-BB	1pc	6-85/11-88	P-UV-10	56 mm	115 mm	FD-251318	78.57
BACKHOE STABILIZER	D8NN-B577-CB	1pc	6-85/11-88	P-SP-10	50 mm	100 mm	FD-251316	106.05
	D8NN-B580-AD	1pc	6-85/6-87	P-UV-10	56 mm	100 mm	FD-251315	47.17
BACKHOE SWING	E4NN-B580-AA	1pc	7-87/11-88	P-UV-10	56 mm	100 mm	FD-251315	47.17
BACKHOE SWING	E0NN-B579-BB		6-85/11-88	P-UV-10	50 mm	110 mm	FD-251303	76.64
LOADER BUCKET	D8NN-L903-FC		6-85/11-88	P-U-10	35 mm	60 mm	FD-251369	26.61
LOADER LIFT	D8NN-L905-FD		6-85/11-88	P-SP-10	40 mm	60 mm	FD-251370	29.89
MODEL 445								
BACKHOE BUCKET	D8NN-B576-EC	1pc	84/5-85	P-UV-10	63 mm	90 mm	FD-251321	74.00

Replacement Kits For

FORD

Loader Backhoes								
APPLICATION	CYL #	Piston Type	SERIAL #	CODE	ROD	BORE	KIT #	List \$
MODEL 445								
BACKHOE BUCKET	D8NN-B576-FB	1pc	78/5-85	P-UV-10	63 mm	90 mm	FD-251321	74.00
	D8NN-B576-FB	2pc	78/11-81	P-UV-9	63 mm	90 mm	FD-251032	109.49
BACKHOE CROWD	D8NN-B578-AA	2pc	78/11-81	P-V-9	50 mm	100 mm	FD-251035	157.42
	D8NN-B578-AA	1pc	78/5-85	P-SP-10	50 mm	100 mm	FD-251316	106.05
	D8NN-B578-AB	1pc	82/5-85	P-SP-10	50 mm	100 mm	FD-251316	106.05
BACKHOE LIFT	D8NN-B578-CC	1pc	78/5-85	P-UV-10	63 mm	115 mm	FD-251319	82.40
	D8NN-B578-CC	2pc	78/11-81	P-UV-9	63 mm	115 mm	FD-251036	93.66
	D8NN-B577-BB	2pc	78/11-81	P-UV-9	56 mm	115 mm	FD-251034	102.17
	D8NN-B577-BB	1pc	78/5-85	P-UV-10	56 mm	115 mm	FD-251318	78.57
BACKHOE STABILIZER	D8NN-B577-CB	2pc	78/11-81	P-V-9	50 mm	100 mm	FD-251035	157.42
	D8NN-B577-CB	1pc	78/5-85	P-SP-10	50 mm	100 mm	FD-251316	106.05
	D8NN-B580-AA	2pc	78/1-83	P-UV-8	50 mm	100 mm	FD-251038	56.90
BACKHOE SWING	D8NN-B580-AA	2pc to 1pc	78/1-83	P-SP-10	50 mm	100 mm	FD-251339	70.53
	D8NN-B580-AD	1pc	2-83/5-85	P-UV-10	56 mm	100 mm	FD-251315	47.17
	D8NN-B579-BE		78/8-82	P-UV-9	56 mm	110 mm	FD-251037	106.80
LOADER BUCKET	E0NN-B579-BB		9-82/5-85	P-UV-10	50 mm	110 mm	FD-251303	76.64
	D8NN-L903-AF		78/5-85	P-SP-10	40 mm	70 mm	FD-251072	23.13
LOADER LIFT	D8NN-L903-DD		78/5-85	P-SP-10	40 mm	70 mm	FD-251072	23.13
	D8NN-L905-DG		78/5-85	P-SP-10	50 mm	70 mm	FD-251162	26.26
MODEL 445A								
BACKHOE BUCKET	D8NN-B576-EC	1pc	6-85/12-86	P-UV-10	63 mm	90 mm	FD-251321	74.00
	D8NN-B576-FB	1pc	6-85/12-86	P-UV-10	63 mm	90 mm	FD-251321	74.00
BACKHOE CROWD	D8NN-B578-AA	1pc	6-85/12-86	P-SP-10	50 mm	100 mm	FD-251316	106.05
	D8NN-B578-AB	1pc	6-85/12-86	P-SP-10	50 mm	100 mm	FD-251316	106.05
	D8NN-B578-CC	1pc	6-85/12-86	P-UV-10	63 mm	115 mm	FD-251319	82.40
BACKHOE LIFT	D8NN-B577-BB	1pc	6-85/12-86	P-UV-10	56 mm	115 mm	FD-251318	78.57
	D8NN-B577-CB	1pc	6-85/12-86	P-SP-10	50 mm	100 mm	FD-251316	106.05
BACKHOE STABILIZER	D8NN-B580-AD	1pc	6-85/12-86	P-UV-10	56 mm	100 mm	FD-251315	47.17
BACKHOE SWING	E0NN-B579-BB		6-85/12-86	P-UV-10	50 mm	110 mm	FD-251303	76.64
LOADER BUCKET	D8NN-L903-AF		6-85/12-86	P-SP-10	40 mm	70 mm	FD-251072	23.13
	D8NN-L903-DD		6-85/12-86	P-SP-10	40 mm	70 mm	FD-251072	23.13
LOADER LIFT	D8NN-L905-DG		6-85/12-86	P-SP-10	50 mm	70 mm	FD-251162	26.26
MODEL 445C								
LOADER BUCKET	F1NN-L903-BA		3-89/6-91, 7-91/-	P-UB-10	40 mm	70 mm	FD-FP419	43.38
LOADER LIFT	F1NN-L905-BB		3-89/6-91, 7-91/11-91	P-UB-10	50 mm	70 mm	FD-FP459	41.24
MODEL 445D								
LOADER BUCKET	F1NN-L903-BA		7-91/	P-UB-10	40 mm	70 mm	FD-FP419	43.38
LOADER LIFT	F1NN-L905-BB		7-91/11-92, 12-92/-	P-UB-10	50 mm	70 mm	FD-FP459	41.24
MODEL 450								
BACKHOE BUCKET	D8NN-B576-EC	1pc	87/11-88	P-UV-10	63 mm	90 mm	FD-251321	74.00
	D8NN-B576-FB	1pc	87/11-88	P-UV-10	63 mm	90 mm	FD-251321	74.00
BACKHOE CROWD	D8NN-B578-AA	1pc	87/11-88	P-SP-10	50 mm	100 mm	FD-251316	106.05

Replacement Kits For

FORD**FORD**

Loader Backhoes								
APPLICATION	CYL #	Piston Type	SERIAL #	CODE	ROD	BORE	KIT #	List \$
MODEL 450								
BACKHOE CROWD	D8NN-B578-AB	1pc	87/11-88	P-SP-10	50 mm	100 mm	FD-251316	106.05
	D8NN-B578-CC	1pc	87/11-88	P-UV-10	63 mm	115 mm	FD-251319	82.40
BACKHOE LIFT	D8NN-B577-BB	1pc	87/11-88	P-UV-10	56 mm	115 mm	FD-251318	78.57
	D8NN-B577-CB	1pc	87/11-88	P-SP-10	50 mm	100 mm	FD-251316	106.05
BACKHOE STABILIZER	D8NN-B580-AD	1pc	1-87/6-87	P-UV-10	56 mm	100 mm	FD-251315	47.17
	E4NN-B580-AA	1pc	7-87/11-88	P-UV-10	56 mm	100 mm	FD-251315	47.17
BACKHOE SWING	E0NN-B579-BB		87/11-88	P-UV-10	50 mm	110 mm	FD-251303	76.64
LOADER BUCKET	D8NN-L903-DD		87/11-88	P-SP-10	40 mm	70 mm	FD-251072	23.13
LOADER LIFT	D8NN-L905-DG		87/11-88	P-SP-10	50 mm	70 mm	FD-251162	26.26
MODEL 455								
BACKHOE BUCKET	D8NN-B576-EC		7-87/11-88	P-UV-10	63 mm	90 mm	FD-251321	74.00
	D8NN-B576-FB		7-87/11-88	P-UV-10	63 mm	90 mm	FD-251321	74.00
BACKHOE CROWD	D8NN-B578-AB		7/87-11-88	P-SP-10	50 mm	100 mm	FD-251316	106.05
	E6NN-B578-AA		7/87-11-88	P-SP-10	50 mm	100 mm	FD-251316	106.05
BACKHOE EXTENDABLE DIPSTICK	E4NN-C492-AA		7-87/11-88	P-V-10	50 mm	80 mm	FD-251317	72.17
BACKHOE LIFT	E6NN-B577-AA		7-87/11-88	P-SP-10	50 mm	100 mm	FD-251316	106.05
	E9NN-B577-AA		7-87/11-88	P-SP-10	50 mm	100 mm	FD-251316	106.05
BACKHOE STABILIZER	E4NN-B580-AA		7-87/11-88	P-UV-10	56 mm	100 mm	FD-251315	47.17
BACKHOE SWING	E6NN-B579-AA		7-87/11-88	P-UV-10	50 mm	110 mm	FD-251303	76.64
LOADER BUCKET LH	E0NN-L904-AA		7-87/11-88	P-U-10	1-1/2	3	FD-251363	18.74
LOADER BUCKET RH	E0NN-L903-AA		7-87/11-88	P-U-10	1-1/2	3	FD-251363	18.74
LOADER LIFT	E4NN-L905-AA		7-87/11-88	P-U-10	2	3	FD-251362	18.09
MODEL 455C								
BACKHOE BUCKET	E7NN-B576-AB		12-88/8-92	P-U-10	63 mm	90 mm	FD-FP456	49.96
BACKHOE CROWD	E7NN-B578-BC		12-88/12-91	P-UB-10	63 mm	115 mm	FD-FP455	66.29
	F1NN-B578-BA		1-92/8-92	P-UB-10	63 mm	115 mm	FD-FP455	66.29
BACKHOE EXTENDABLE DIPSTICK	E7NN-C492-AB		12-88/8-92	P-UB-10	50 mm	80 mm	FD-FP457	36.96
BACKHOE LIFT	E7NN-B577-CC		12-88/12-91	P-UB-10	56 mm	115 mm	FD-FP454	97.66
	F1NN-B577-AA		1-92/8-92	P-UB-10	56 mm	115 mm	FD-FP454	97.66
BACKHOE STABILIZER	E7NN-B580-AE		12-88/4-92	P-UB-10	56 mm	100 mm	FD-FP458	71.56
	F1NN-B580-AA		5-92/8-92	P-UB-10	56 mm	100 mm	FD-FP458	71.56
BACKHOE SWING	E7NN-B579-AC		12-88/8-92	P-UB-10	50 mm	110 mm	FD-FP460	72.61
LOADER BUCKET	E7NN-L903-BA		12-88/6-91	P-UB-10	40 mm	80 mm	FD-85804740	40.21
	F1NN-L903-CA		7-91/8-92	P-UB-10	40 mm	80 mm	FD-85804740	40.21
LOADER LIFT	E7NN-L905-AC		12-88/8-92	P-UB-10	50 mm	80 mm	FD-FP417	42.09
MODEL 455D								
BACKHOE BUCKET	E7NN-B576-AB		9-92/	P-U-10	63 mm	90 mm	FD-FP456	49.96
BACKHOE CROWD	F1NN-B578-BA		9-92/	P-UB-10	63 mm	115 mm	FD-FP455	66.29
BACKHOE EXTENDABLE DIPSTICK	E7NN-C492-AB		9-92/8-93	P-UB-10	50 mm	80 mm	FD-FP457	36.96
	E7NN-C492-AD		9-93/	P-UB-10	50 mm	80 mm	FD-FP457	36.96
BACKHOE LIFT	F1NN-B577-AA		9-92/	P-UB-10	56 mm	115 mm	FD-FP454	97.66
BACKHOE STABILIZER	F1NN-B580-AA		9-92/8-93	P-UB-10	56 mm	100 mm	FD-FP458	71.56

Replacement Kits For

FORD

Loader Backhoes								
APPLICATION	CYL #	Piston Type	SERIAL #	CODE	ROD	BORE	KIT #	List \$
MODEL 455D								
BACKHOE STABILIZER	F2NN-B580-AA		9-93/	P-UB-10	56 mm	100 mm	FD-FP458	71.56
BACKHOE SWING	E7NN-B579-AC		9-92/8-93	P-UB-10	50 mm	110 mm	FD-FP460	72.61
	E7NN-B579-AD		9-93/	P-UB-10	50 mm	110 mm	FD-FP460	72.61
LOADER BUCKET	F1NN-L903-CA		9-92/	P-UB-10	40 mm	80 mm	FD-85804740	40.21
LOADER LIFT	E7NN-L905-AC		9-92/	P-UB-10	50 mm	80 mm	FD-FP417	42.09
MODEL 545								
BACKHOE BUCKET	D8NN-B576-EC	1pc	84/5-85	P-UV-10	63 mm	90 mm	FD-251321	74.00
	D8NN-B576-FB	2pc	78/11-81	P-UV-9	63 mm	90 mm	FD-251032	109.49
	D8NN-B576-FB	1pc	78/5-85	P-UV-10	63 mm	90 mm	FD-251321	74.00
BACKHOE CROWD	D8NN-B578-AA	1pc	78/5-85	P-SP-10	50 mm	100 mm	FD-251316	106.05
	D8NN-B578-AA	2pc	78/11-81	P-V-9	50 mm	100 mm	FD-251035	157.42
	D8NN-B578-AB	1pc	82/5-85	P-SP-10	50 mm	100 mm	FD-251316	106.05
	D8NN-B578-CC	1pc	78/5-85	P-UV-10	63 mm	115 mm	FD-251319	82.40
BACKHOE LIFT	D8NN-B578-CC	2pc	78/11-81	P-UV-9	63 mm	115 mm	FD-251036	93.66
	D8NN-B577-BB	1pc	78/5-85	P-UV-10	56 mm	115 mm	FD-251318	78.57
	D8NN-B577-BB	2pc	78/11-81	P-UV-9	56 mm	115 mm	FD-251034	102.17
	D8NN-B577-CB	1pc	78/5-85	P-SP-10	50 mm	100 mm	FD-251316	106.05
BACKHOE STABILIZER	D8NN-B577-CB	2pc	78/11-81	P-V-9	50 mm	100 mm	FD-251035	157.42
	D8NN-B580-AA	2pc	78/1-83	P-UV-8	50 mm	100 mm	FD-251038	56.90
	D8NN-B580-AA	2pc to 1pc	78/1-83	P-SP-10	50 mm	100 mm	FD-251339	70.53
BACKHOE SWING	D8NN-B580-AD	1pc	2-83/5-85	P-UV-10	56 mm	100 mm	FD-251315	47.17
	D8NN-B579-BE		78/8-82	P-UV-9	56 mm	110 mm	FD-251037	106.80
LOADER BUCKET	E0NN-B579-BB		9-82/5-85	P-UV-10	50 mm	110 mm	FD-251303	76.64
	D8NN-L903-AF		78/5-85	P-SP-10	40 mm	70 mm	FD-251072	23.13
LOADER LIFT	D8NN-L903-CE		78/5-85	P-U-10	40 mm	80 mm	FD-251073	33.37
	D8NN-L903-DD		78/5-85	P-SP-10	40 mm	70 mm	FD-251072	23.13
	D8NN-L905-CE		78/5-85	P-SP-10	50 mm	80 mm	FD-251074	27.52
	D8NN-L905-DG		78/5-85	P-SP-10	50 mm	70 mm	FD-251162	26.26
MODEL 545A								
BACKHOE BUCKET	D8NN-B576-EC	1pc	6-85/11-88	P-UV-10	63 mm	90 mm	FD-251321	74.00
	D8NN-B576-FB	1pc	6-85/11-88	P-UV-10	63 mm	90 mm	FD-251321	74.00
BACKHOE CROWD	D8NN-B578-AA	1pc	6-85/11-88	P-SP-10	50 mm	100 mm	FD-251316	106.05
	D8NN-B578-AB	1pc	6-85/11-88	P-SP-10	50 mm	100 mm	FD-251316	106.05
	D8NN-B578-CC	1pc	6-85/11-88	P-UV-10	63 mm	115 mm	FD-251319	82.40
BACKHOE LIFT	D8NN-B577-BB	1pc	6-85/11-88	P-UV-10	56 mm	115 mm	FD-251318	78.57
	D8NN-B577-CB	1pc	6-85/11-88	P-SP-10	50 mm	100 mm	FD-251316	106.05
BACKHOE STABILIZER	D8NN-B580-AD	1pc	6-85/6-87	P-UV-10	56 mm	100 mm	FD-251315	47.17
	E4NN-B580-AA	1pc	7-87/11-88	P-UV-10	56 mm	100 mm	FD-251315	47.17
BACKHOE SWING	E0NN-B579-BB		6-85/11-88	P-UV-10	50 mm	110 mm	FD-251303	76.64
LOADER BUCKET	D8NN-L903-AF		6-85/11-88	P-SP-10	40 mm	70 mm	FD-251072	23.13
	D8NN-L903-CE		6-85/11-88	P-U-10	40 mm	80 mm	FD-251073	33.37
	D8NN-L903-DD		6-85/11-88	P-SP-10	40 mm	70 mm	FD-251072	23.13
LOADER LIFT	D8NN-L905-CE		6-85/11-88	P-SP-10	50 mm	80 mm	FD-251074	27.52
	D8NN-L905-DG		6-85/11-88	P-SP-10	50 mm	70 mm	FD-251162	26.26

Replacement Kits For

FORD**FORD**

Loader Backhoes								
APPLICATION	CYL #	Piston Type	SERIAL #	CODE	ROD	BORE	KIT #	List \$
MODEL 545C								
LOADER BUCKET	E7NN-L903-BA		3-89/6-91	P-UB-10	40 mm	80 mm	FD-85804740	40.21
	F1NN-L903-CA		7-91/	P-UB-10	40 mm	80 mm	FD-85804740	40.21
LOADER LIFT	E7NN-L905-DA		3-89/6-91	P-UB-10	50 mm	80 mm	FD-FP417	42.09
	F1NN-L905-AB		7-91/11-92	P-UB-10	50 mm	80 mm	FD-FP417	42.09
MODEL 545D								
LOADER BUCKET	F1NN-L903-CA		7-91/	P-UB-10	40 mm	80 mm	FD-85804740	40.21
LOADER LIFT	F1NN-L905-AB		7-91/11-92, 12-92/	P-UB-10	50 mm	80 mm	FD-FP417	42.09
MODEL 550								
BACKHOE BUCKET	D5NN-B576-B		75/83		2-1/2	3.52	FD-309949	60.43
BACKHOE CROWD	D5NN-B578-C		75/83	P-V-9	2-1/4	4-1/2	FD-309948	65.92
	D7NN-B578-C		75/83	P-V-9	2	4	FD-309946	70.26
BACKHOE LIFT HEAVY DUTY	D7NN-B577-F		77/78	P-V-9	2-1/2	5	FD-309962	70.65
BACKHOE LIFT-CENTER PIVOT	D7NN-B577-B		75/83	P-V-9	2	4-1/2	FD-309947	57.93
	D7NN-B577-C		75/83	P-V-9	2	4	FD-309946	70.26
BACKHOE LIFT-SIDESHIFT	D7NN-B577-B		4-78/83	P-V-9	2	4-1/2	FD-309947	57.93
	D7NN-B577-D		75/3-78	P-V-9	2	4	FD-309946	70.26
BACKHOE STABILIZER-CENTERPIVOT	D7NN-B580-C		75/78	P-V-8	1-3/4	4	FD-309940	45.49
BACKHOE STABILIZER-SIDESHIFT	D8NN-B580-CA		75/83	P-V-8	1-1/2	3	FD-309974F	58.67
BACKHOE SWING-CENTER PIVOT	D7NN-B579-D		75/83	P-V-8	1-3/4	4-1/2	FD-309939	49.00
	D7NN-B579-E		75/83	P-V-8	1-3/4	4	FD-309940	45.49
LOADER BUCKET LH	D5NN-L904-A		75/83	P-U-8	1-1/2	3	FD-309985F	38.05
LOADER BUCKET RH	D5NN-L903-C		75/83	P-U-8	1-1/2	3	FD-309985F	38.05
LOADER LIFT	E3NN-L905-AA		75/83	P-U-8	2	3	FD-309984F	38.33
MODEL 555								
BACKHOE BUCKET	D8NN-B576-EC	1pc	10-78/10-88	P-UV-10	63 mm	90 mm	FD-251321	74.00
	D8NN-B576-EC	2pc	10-78/11-81	P-UV-9	63 mm	90 mm	FD-251032	109.49
BACKHOE CROWD	D8NN-B578-BB	2pc	10-78/11-81	P-UV-9	63 mm	115 mm	FD-251036	93.66
	D8NN-B578-BB	1pc	10-78/10-88	P-UV-10	63 mm	115 mm	FD-251319	82.40
	D8NN-B578-CC	2pc	10-78/11-81	P-UV-9	63 mm	115 mm	FD-251036	93.66
	D8NN-B578-CC	1pc	10-78/10-88	P-UV-10	63 mm	115 mm	FD-251319	82.40
BACKHOE EXTENDABLE DIPSTICK	D8NN-C492-BB	1pc	10-78/7-87	P-V-10	50 mm	80 mm	FD-251317	72.17
BACKHOE LIFT	D8NN-B577-AB	1pc	10-78/10-88	P-UV-10	63 mm	125 mm	FD-251320	81.21
	D8NN-B577-AB	2pc	10-78/81	P-UV-9	63 mm	125 mm	FD-251033	105.27
	D8NN-B577-BB	2pc	10-78/81	P-UV-9	56 mm	115 mm	FD-251034	102.17
	D8NN-B577-BB	1pc	10-78/10-88	P-UV-10	56 mm	115 mm	FD-251318	78.57
BACKHOE STABILIZER-CENTERPIVOT	D8NN-B580-AA	1pc	10-78/1-83	P-SP-10	50 mm	100 mm	FD-251339	70.53
	D8NN-B580-AA	2pc	10-78/1-83	P-UV-8	50 mm	100 mm	FD-251038	56.90
	D8NN-B580-AD	1pc	2-83/6-87	P-UV-10	56 mm	100 mm	FD-251315	47.17

Replacement Kits For

FORD

Loader Backhoes								
APPLICATION	CYL #	Piston Type	SERIAL #	CODE	ROD	BORE	KIT #	List \$
MODEL 555								
BACKHOE STABILIZER-CENTERPIVOT	E4NN-B580-AA	1pc	7-87/10-88	P-UV-10	56 mm	100 mm	FD-251315	47.17
BACKHOE STABILIZER-SIDESHIFT	E0NN-B580-AA		84/10-88	P-U-10	45 mm	70 mm	FD-251361	60.38
BACKHOE SWING	D8NN-B579-BE		10-78/8-82	P-UV-9	56 mm	110 mm	FD-251037	106.80
BACKHOE SWING-CENTER PIVOT	E6NN-B579-AA		9-82/10-88	P-UV-10	50 mm	110 mm	FD-251303	76.64
BACKHOE SWING-SIDESHIFT	E1NN-B579-AB		84/10-88	P-UV-10	50 mm	110 mm	FD-251303	76.64
LOADER BUCKET LH	D5NN-L904-A		10-78/83	P-U-8	1-1/2	3	FD-309985F	38.05
	E0NN-L904-AA		84/10-88	P-U-10	1-1/2	3	FD-251363	18.74
LOADER BUCKET RH	D5NN-L903-C		10-78/83	P-U-8	1-1/2	3	FD-309985F	38.05
	E0NN-L903-AA		84/10-88	P-U-10	1-1/2	3	FD-251363	18.74
LOADER LIFT	E3NN-L905-AA		10-78/83	P-U-8	2	3	FD-309984F	38.33
	E4NN-L905-AA		84/10-88	P-U-10	2	3	FD-251362	18.09
MODEL 555A								
BACKHOE BUCKET	D8NN-B576-EC	1pc	84/5-85	P-UV-10	63 mm	90 mm	FD-251321	74.00
BACKHOE CROWD	D8NN-B578-BB	1pc	84/5-85	P-UV-10	63 mm	115 mm	FD-251319	82.40
	D8NN-B578-CC	1pc	84/5-85	P-UV-10	63 mm	115 mm	FD-251319	82.40
BACKHOE EXTENDABLE DIPSTICK	D8NN-C492-BB	1pc	84/5-85	P-V-10	50 mm	80 mm	FD-251317	72.17
BACKHOE LIFT	D8NN-B577-AB	1pc	84/5-85	P-UV-10	63 mm	125 mm	FD-251320	81.21
	D8NN-B577-BB	1pc	84/5-85	P-UV-10	56 mm	115 mm	FD-251318	78.57
BACKHOE STABILIZER-CENTERPIVOT	D8NN-B580-AD	1pc	84/5-85	P-UV-10	56 mm	100 mm	FD-251315	47.17
BACKHOE STABILIZER-SIDESHIFT	E0NN-B580-AA		84/5-85	P-U-10	45 mm	70 mm	FD-251361	60.38
BACKHOE SWING-CENTER PIVOT	E6NN-B579-AA		84/5-85	P-UV-10	50 mm	110 mm	FD-251303	76.64
BACKHOE SWING-SIDESHIFT	E1NN-B579-AB		84/5-85	P-UV-10	50 mm	110 mm	FD-251303	76.64
LOADER BUCKET LH	E0NN-L904-AA		84/5-85	P-U-10	1-1/2	3	FD-251363	18.74
LOADER BUCKET RH	E0NN-L903-AA		84/5-85	P-U-10	1-1/2	3	FD-251363	18.74
LOADER LIFT	E4NN-L905-AA		84/5-85	P-U-10	2	3	FD-251362	18.09
MODEL 555A-XL								
BACKHOE BUCKET	D8NN-B576-EC			P-UV-10	63 mm	90 mm	FD-251321	74.00
BACKHOE CROWD	D8NN-B578-BB			P-UV-10	63 mm	115 mm	FD-251319	82.40
	D8NN-B578-CC			P-UV-10	63 mm	115 mm	FD-251319	82.40
BACKHOE EXTENDABLE DIPSTICK	D8NN-C492-BB			P-V-10	50 mm	80 mm	FD-251317	72.17
BACKHOE LIFT	D8NN-B577-AB			P-UV-10	63 mm	125 mm	FD-251320	81.21
	D8NN-B577-BB			P-UV-10	56 mm	115 mm	FD-251318	78.57
BACKHOE STABILIZER-CENTERPIVOT	D8NN-B580-AD			P-UV-10	56 mm	100 mm	FD-251315	47.17
BACKHOE STABILIZER-SIDESHIFT	E0NN-B580-AA			P-U-10	45 mm	70 mm	FD-251361	60.38
BACKHOE SWING-CENTER PIVOT	E6NN-B579-AA			P-UV-10	50 mm	110 mm	FD-251303	76.64

FORD

Replacement Kits For

FORD

Loader Backhoes								
APPLICATION	CYL #	Piston Type	SERIAL #	CODE	ROD	BORE	KIT #	List \$
MODEL 555A-XL								
BACKHOE SWING-SIDESHIFT	E1NN-B579-AB			P-UV-10	50 mm	110 mm	FD-251303	76.64
LOADER BUCKET LH	E0NN-L904-AA			P-U-10	1-1/2	3	FD-251363	18.74
LOADER BUCKET RH	E0NN-L903-AA			P-U-10	1-1/2	3	FD-251363	18.74
LOADER LIFT	E4NN-L905-AA			P-U-10	2	3	FD-251362	18.09
MODEL 555B								
BACKHOE BUCKET	D8NN-B576-EC	1pc	6-85/10-88	P-UV-10	63 mm	90 mm	FD-251321	74.00
BACKHOE CROWD	D8NN-B578-BB	1pc	6-85/10-88	P-UV-10	63 mm	115 mm	FD-251319	82.40
	D8NN-B578-CC	1pc	6-85/10-88	P-UV-10	63 mm	115 mm	FD-251319	82.40
BACKHOE LIFT	D8NN-B577-AB	1pc	6-85/10-88	P-UV-10	63 mm	125 mm	FD-251320	81.21
	D8NN-B577-BB	1pc	6-85/10-88	P-UV-10	56 mm	115 mm	FD-251318	78.57
BACKHOE STABILIZER-CENTERPIVOT	D8NN-B580-AD	1pc	6-85/6-87	P-UV-10	56 mm	100 mm	FD-251315	47.17
	E4NN-B580-AA	1pc	7-87/10-88	P-UV-10	56 mm	100 mm	FD-251315	47.17
BACKHOE STABILIZER-SIDESHIFT	E0NN-B580-AA		6-85/10-88	P-U-10	45 mm	70 mm	FD-251361	60.38
BACKHOE SWING-CENTER PIVOT	E6NN-B579-AA		6-85/10-88	P-UV-10	50 mm	110 mm	FD-251303	76.64
BACKHOE SWING-SIDESHIFT	E1NN-B579-AB		6-85/10-88	P-UV-10	50 mm	110 mm	FD-251303	76.64
LOADER BUCKET LH	E0NN-L904-AA		6-85/10-88	P-U-10	1-1/2	3	FD-251363	18.74
LOADER BUCKET RH	E0NN-L903-AA		6-85/10-88	P-U-10	1-1/2	3	FD-251363	18.74
LOADER LIFT	E4NN-L905-AA		6-85/10-88	P-U-10	2	3	FD-251362	18.09
MODEL 555C								
BACKHOE BUCKET	E7NN-B576-AB		11-88/8-92	P-U-10	63 mm	90 mm	FD-FP456	49.96
BACKHOE CROWD	F1NN-B578-AA		11-88/8-92	P-UB-10	63 mm	115 mm	FD-FP455	66.29
BACKHOE EXTENDABLE DIPSTICK	E7NN-C492-AB		11-88/8-92	P-UB-10	50 mm	80 mm	FD-FP457	36.96
BACKHOE LIFT W/HED	E7NN-B577-AE		11-88/12-91	P-UB-10	63 mm	125 mm	FD-85804741	94.80
BACKHOE LIFT W/O HED	E7NN-B577-BE		11-88/12-91	P-UB-10	56 mm	115 mm	FD-FP454	97.66
BACKHOE STABILIZER-CENTERPIVOT	F2NN-B580-AA		11-88/8-92	P-UB-10	56 mm	100 mm	FD-FP458	71.56
BACKHOE STABILIZER-SIDESHIFT	E7NN-B580-BA		11-88/8-92	P-UB-10	50 mm	70 mm	FD-FP459	41.24
BACKHOE SWING - CENTER PIVOT	E7NN-B579-BA		11-88/8-92	P-UB-10	50 mm	110 mm	FD-FP460	72.61
BACKHOE SWING - SIDE SHIFT	E7NN-B579-BA		11-88/8-92	P-UB-10	50 mm	110 mm	FD-FP460	72.61
LOADER BUCKET LH	F1NN-L904-AA		11-88/8-92	P-UB-10	40 mm	80 mm	FD-85804740	40.21
LOADER BUCKET RH	F1NN-L903-AA		11-88/8-92	P-UB-10	40 mm	80 mm	FD-85804740	40.21
LOADER BUCKET-MULTIPURPOSE	E7NN-A136-AA		11-88/5-92	P-UB-10	40 mm	70 mm	FD-FP419	43.38
LOADER LIFT	E7NN-L905-BB		11-88/8-92	P-UB-10	50 mm	80 mm	FD-FP417	42.09
MODEL 555D								
BACKHOE BUCKET	E7NN-B576-AB		9-92/	P-U-10	63 mm	90 mm	FD-FP456	49.96
BACKHOE CROWD	F1NN-B578-AA		9-92/	P-UB-10	63 mm	115 mm	FD-FP455	66.29
BACKHOE EXTENDABLE DIPSTICK	E7NN-C492-AB		9-92/8-93	P-UB-10	50 mm	80 mm	FD-FP457	36.96

Replacement Kits For

FORD

Loader Backhoes								
APPLICATION	CYL #	Piston Type	SERIAL #	CODE	ROD	BORE	KIT #	List \$
MODEL 555D								
BACKHOE EXTENDABLE DIPSTICK	E7NN-C492-AD		9-93/	P-UB-10	50 mm	80 mm	FD-FP457	36.96
BACKHOE LIFT W/HED	F1NN-B577-CA		9-92/	P-UB-10	63 mm	125 mm	FD-85804741	94.80
BACKHOE LIFT W/O HED	F1NN-B577-BA		9-92/	P-UB-10	56 mm	115 mm	FD-FP454	97.66
BACKHOE STABILIZER-CENTERPIVOT	F2NN-B580-AA		9-92/	P-UB-10	56 mm	100 mm	FD-FP458	71.56
BACKHOE STABILIZER-SIDESHIFT	E7NN-B580-BA		9-92/8-93	P-UB-10	50 mm	70 mm	FD-FP459	41.24
	E7NN-B580-BB		9-93/	P-UB-10	50 mm	70 mm	FD-FP459	41.24
BACKHOE SWING - CENTER PIVOT	E7NN-B579-AB		9-92/8-93	P-UB-10	50 mm	110 mm	FD-FP460	72.61
	E7NN-B579-AD		9-93/	P-UB-10	50 mm	110 mm	FD-FP460	72.61
BACKHOE SWING - SIDE SHIFT	E7NN-B579-BA		9-92/8-93	P-UB-10	50 mm	110 mm	FD-FP460	72.61
	E7NN-B579-BC		9-93/	P-UB-10	50 mm	110 mm	FD-FP460	72.61
LOADER BUCKET LH	F1NN-L904-AA		9-92/	P-UB-10	40 mm	80 mm	FD-85804740	40.21
LOADER BUCKET RH	F1NN-L903-AA		9-92/	P-UB-10	40 mm	80 mm	FD-85804740	40.21
LOADER BUCKET-MULTIPURPOSE	F1NN-A136-AA		9-92/	P-UB-10	40 mm	70 mm	FD-FP419	43.38
LOADER LIFT	E7NN-L905-BC		4-93/	P-UB-10	50 mm	80 mm	FD-FP417	42.09
POWER STEERING	F1NN-3A540-AA		5-92/	I-U-10	40 mm	2-3/4	FD-FINN3A539AA	26.07
MODEL 555E								
BACKHOE BOOM LIFT	85800400			P-UB-10	63 mm	125 mm	FD-85804741	94.80
BACKHOE BUCKET	83962129			P-U-10	63 mm	90 mm	FD-85804743	78.52
BACKHOE CROWD	81873434			P-UB-10	63 mm	115 mm	FD-85804742	104.32
BACKHOE H.E.D.	85800800			P-UB-10	50 mm	70 mm	FD-85802569	41.21
BACKHOE STABILIZER	85800600			P-UB-10	56 mm	100 mm	FD-83971999	70.57
BACKHOE SWING	85800300			P-UB-10	50 mm	110 mm	FD-85802570	46.79
LOADER BUCKET	85800500			P-UB-10	40 mm	80 mm	FD-85804740	40.21
LOADER LIFT	85800100			P-UB-10	50 mm	90 mm	FD-85802567	40.53
MODEL 575D								
BACKHOE BUCKET	E7NN-B576-AB		9-92/	P-U-10	63 mm	90 mm	FD-FP456	49.96
BACKHOE CROWD	F1NN-B578-AA		9-92/	P-UB-10	63 mm	115 mm	FD-FP455	66.29
BACKHOE EXTENDABLE DIPSTICK	E7NN-C492-AD		9-93/	P-UB-10	50 mm	80 mm	FD-FP457	36.96
BACKHOE STABILIZER-CENTERPIVOT	F2NN-B580-AA		9-92/	P-UB-10	56 mm	100 mm	FD-FP458	71.56
BACKHOE STABILIZER-SIDESHIFT	E7NN-B580-BA		9-92/8-93	P-UB-10	50 mm	70 mm	FD-FP459	41.24
	E7NN-B580-BB		9-93/	P-UB-10	50 mm	70 mm	FD-FP459	41.24
BACKHOE SWING - CENTER PIVOT	E7NN-B579-AD		9-93/	P-UB-10	50 mm	110 mm	FD-FP460	72.61
	E7NN-B579-BA		9-92/8-93	P-UB-10	50 mm	110 mm	FD-FP460	72.61
BACKHOE SWING - SIDE SHIFT	E7NN-B579-BA		9-92/8-93	P-UB-10	50 mm	110 mm	FD-FP460	72.61
	E7NN-B579-BC		9-93/	P-UB-10	50 mm	110 mm	FD-FP460	72.61
LOADER BUCKET LH	F1NN-L904-AA		9-92/	P-UB-10	40 mm	80 mm	FD-85804740	40.21

Replacement Kits For

FORD**FORD**

Loader Backhoes								
APPLICATION	CYL #	Piston Type	SERIAL #	CODE	ROD	BORE	KIT #	List \$
MODEL 575D								
LOADER BUCKET RH	F1NN-L903-AA		9-92/	P-UB-10	40 mm	80 mm	FD-85804740	40.21
LOADER BUCKET-MULTIPURPOSE	F1NN-A136-AA		9-92/	P-UB-10	40 mm	70 mm	FD-FP419	43.38
LOADER LIFT	E7NN-L905-BC		4-93/	P-UB-10	50 mm	80 mm	FD-FP417	42.09
MODEL 575E								
BACKHOE BOOM LIFT	85800400			P-UB-10	63 mm	125 mm	FD-85804741	94.80
BACKHOE BUCKET	83962129			P-U-10	63 mm	90 mm	FD-85804743	78.52
BACKHOE CROWD	81873434			P-UB-10	63 mm	115 mm	FD-85804742	104.32
BACKHOE H.E.D.	85800800			P-UB-10	50 mm	70 mm	FD-85802569	41.21
BACKHOE STABILIZER	85800600			P-UB-10	56 mm	100 mm	FD-83971999	70.57
BACKHOE SWING	85800300			P-UB-10	50 mm	110 mm	FD-85802570	46.79
LOADER BUCKET	85800500			P-UB-10	40 mm	80 mm	FD-85804740	40.21
LOADER LIFT	85800100			P-UB-10	50 mm	90 mm	FD-85802567	40.53
MODEL 650								
BACKHOE BUCKET	D5NN-B576-B		11-75/77		2-1/2	3.52	FD-309949	60.43
BACKHOE CROWD	D7NN-B578-B		11-75/77	P-V-9	2-1/4	4-1/2	FD-309948	65.92
BACKHOE LIFT	D7NN-B577-F		11-75/77	P-V-9	2-1/2	5	FD-309962	70.65
BACKHOE STABILIZER	D7NN-B580-C		11-75/77	P-V-8	1-3/4	4	FD-309940	45.49
BACKHOE SWING	D7NN-B579-D		11-75/77	P-V-8	1-3/4	4-1/2	FD-309939	49.00
LOADER BUCKET	D7NN-L903-A		11-75/77	P-V-9	2-1/4	4	FD-309951	62.26
LOADER HYDRO BUCKET	7708113		11-75/77	P-U-13	2	3	FD-7708145	27.69
LOADER LIFT	D7NN-L905-F		11-75/77	P-V-9	2-1/4	4	FD-309951	62.26
MODEL 655								
BACKHOE BUCKET		2pc			2-1/2	3.52	FD-309949	60.43
	D8NN-B576-EC	1pc	7-85/10-88	P-UV-10	63 mm	90 mm	FD-251321	74.00
BACKHOE CROWD		2pc		P-V-9	2-1/4	4-1/2	FD-309948	65.92
	D8NN-B578-BB	1pc	7-85/10-88	P-UV-10	63 mm	115 mm	FD-251319	82.40
	D8NN-B578-CC	1pc	7-85/10-88	P-UV-10	63 mm	115 mm	FD-251319	82.40
BACKHOE EXTENDABLE DIPSTICK	D8NN-C492-BB	1pc	7-85/7-87	P-V-10	50 mm	80 mm	FD-251317	72.17
BACKHOE LIFT		2pc		P-V-9	2	4-1/2	FD-309947	57.93
	D8NN-B577-AB	1pc	7-85/10-88	P-UV-10	63 mm	125 mm	FD-251320	81.21
	D8NN-B577-BB	1pc	7-85/10-88	P-UV-10	56 mm	115 mm	FD-251318	78.57
BACKHOE STABILIZER		2pc		P-V-8	1-3/4	4	FD-309940	45.49
BACKHOE STABILIZER-CENTERPIVOT	D8NN-B580-AD	1pc	7-85/6-87	P-UV-10	56 mm	100 mm	FD-251315	47.17
	E4NN-B580-AA	1pc	7-87/10-88	P-UV-10	56 mm	100 mm	FD-251315	47.17
BACKHOE STABILIZER-SIDESHIFT	E0NN-B580-AA		7-85/10-88	P-U-10	45 mm	70 mm	FD-251361	60.38
BACKHOE SWING		2pc		P-V-8	1-3/4	4-1/2	FD-309939	49.00
BACKHOE SWING-CENTER PIVOT	E6NN-B579-AA		7-85/10-88	P-UV-10	50 mm	110 mm	FD-251303	76.64
BACKHOE SWING-SIDESHIFT	E1NN-B579-AB		7-85/10-88	P-UV-10	50 mm	110 mm	FD-251303	76.64
LOADER BUCKET LH	E0NN-L904-AA		7-85/10-88	P-U-10	1-1/2	3	FD-251363	18.74
LOADER BUCKET RH	E0NN-L903-AA		7-85/10-88	P-U-10	1-1/2	3	FD-251363	18.74

Replacement Kits For

FORD

Loader Backhoes								
APPLICATION	CYL #	Piston Type	SERIAL #	CODE	ROD	BORE	KIT #	List \$
MODEL 655								
LOADER LIFT	E4NN-L905-AA		7-85/10-88	P-U-10	2	3	FD-251362	18.09
MODEL 655A								
BACKHOE BUCKET	D8NN-B576-EC	1pc	6-85/10-88	P-UV-10	63 mm	90 mm	FD-251321	74.00
BACKHOE CROWD	D8NN-B578-BB	1pc	6-85/10-88	P-UV-10	63 mm	115 mm	FD-251319	82.40
	D8NN-B578-CC	1pc	6-85/10-88	P-UV-10	63 mm	115 mm	FD-251319	82.40
BACKHOE EXTENDABLE DIPSTICK	D8NN-C492-BB	1pc	6-85/7-87	P-V-10	50 mm	80 mm	FD-251317	72.17
BACKHOE LIFT	D8NN-B577-AB	1pc	6-85/10-88	P-UV-10	63 mm	125 mm	FD-251320	81.21
	D8NN-B577-BB	1pc	6-85/10-88	P-UV-10	56 mm	115 mm	FD-251318	78.57
BACKHOE STABILIZER- CENTERPIVOT	D8NN-B580-AD	1pc	6-85/6-87	P-UV-10	56 mm	100 mm	FD-251315	47.17
	E4NN-B580-AA	1pc	7-87/10-88	P-UV-10	56 mm	100 mm	FD-251315	47.17
BACKHOE STABILIZER- SIDESHIFT	E0NN-B580-AA		6-85/10-88	P-U-10	45 mm	70 mm	FD-251361	60.38
BACKHOE SWING- CENTER PIVOT	E6NN-B579-AA		6-85/10-88	P-UV-10	50 mm	110 mm	FD-251303	76.64
BACKHOE SWING- SIDESHIFT	E1NN-B579-AB		6-85/10-88	P-UV-10	50 mm	110 mm	FD-251303	76.64
LOADER BUCKET LH	E0NN-L904-AA		6-85/10-88	P-U-10	1-1/2	3	FD-251363	18.74
LOADER BUCKET RH	E0NN-L903-AA		6-85/10-88	P-U-10	1-1/2	3	FD-251363	18.74
LOADER LIFT	E4NN-L905-AA		6-85/10-88	P-U-10	2	3	FD-251362	18.09
MODEL 655C								
BACKHOE BUCKET	E7NN-B576-AB		11-88/8-92	P-U-10	63 mm	90 mm	FD-FP456	49.96
BACKHOE CROWD	F1NN-B578-AA		11-88/8-92	P-UB-10	63 mm	115 mm	FD-FP455	66.29
BACKHOE EXTENDABLE DIPSTICK	E7NN-C492-BD		11-88/8-92	P-UB-10	50 mm	80 mm	FD-FP457	36.96
BACKHOE LIFT	E7NN-B577-AE		11-88/12-91	P-UB-10	63 mm	125 mm	FD-85804741	94.80
BACKHOE STABILIZER- CENTERPIVOT	F2NN-B580-AA		11-88/8-92	P-UB-10	56 mm	100 mm	FD-FP458	71.56
BACKHOE STABILIZER- SIDESHIFT	E7NN-B580-BA		11-88/8-92	P-UB-10	50 mm	70 mm	FD-FP459	41.24
BACKHOE SWING - CENTER PIVOT	E7NN-B579-BA		11-88/8-92	P-UB-10	50 mm	110 mm	FD-FP460	72.61
BACKHOE SWING - SIDE SHIFT	E7NN-B579-BA		11-88/8-92	P-UB-10	50 mm	110 mm	FD-FP460	72.61
LOADER BUCKET LH	F1NN-L904-AA		11-88/8-92	P-UB-10	40 mm	80 mm	FD-85804740	40.21
LOADER BUCKET RH	F1NN-L903-AA		11-88/8-92	P-UB-10	40 mm	80 mm	FD-85804740	40.21
LOADER BUCKET- MULTIPURPOSE	E7NN-A136-AA		11-88/5-92	P-UB-10	40 mm	70 mm	FD-FP419	43.38
LOADER LIFT	E7NN-L905-BB		11-88/8-92	P-UB-10	50 mm	80 mm	FD-FP417	42.09
MODEL 655D								
BACKHOE BUCKET	E7NN-B576-AB		9-92/	P-U-10	63 mm	90 mm	FD-FP456	49.96
BACKHOE CROWD	F1NN-B578-AA		9-92/	P-UB-10	63 mm	115 mm	FD-FP455	66.29
BACKHOE EXTENDABLE DIPSTICK	E7NN-C492-BD		9-92/	P-UB-10	50 mm	80 mm	FD-FP457	36.96
BACKHOE LIFT	F1NN-B577-CA		9-92/	P-UB-10	63 mm	125 mm	FD-85804741	94.80
BACKHOE STABILIZER- CENTERPIVOT	F2NN-B580-AA		9-92/	P-UB-10	56 mm	100 mm	FD-FP458	71.56

Replacement Kits For

FORD**FORD**

Loader Backhoes								
APPLICATION	CYL #	Piston Type	SERIAL #	CODE	ROD	BORE	KIT #	List \$
MODEL 655D								
BACKHOE STABILIZER-SIDESHIFT	E7NN-B580-BA		9-92/8-93	P-UB-10	50 mm	70 mm	FD-FP459	41.24
	E7NN-B580-BB		9-93/	P-UB-10	50 mm	70 mm	FD-FP459	41.24
BACKHOE SWING - CENTER PIVOT	E7NN-B579-AD		9-93/	P-UB-10	50 mm	110 mm	FD-FP460	72.61
	E7NN-B579-BA		9-92/8-93	P-UB-10	50 mm	110 mm	FD-FP460	72.61
BACKHOE SWING - SIDE SHIFT	E7NN-B579-BA		9-92/8-93	P-UB-10	50 mm	110 mm	FD-FP460	72.61
	E7NN-B579-BC		9-93/	P-UB-10	50 mm	110 mm	FD-FP460	72.61
LOADER BUCKET LH	F1NN-L904-AA		9-92/	P-UB-10	40 mm	80 mm	FD-85804740	40.21
LOADER BUCKET RH	F1NN-L903-AA		9-92/	P-UB-10	40 mm	80 mm	FD-85804740	40.21
LOADER BUCKET-MULTIPURPOSE	F1NN-A136-AA		9-92/	P-UB-10	40 mm	70 mm	FD-FP419	43.38
LOADER LIFT	E7NN-L905-BC		4-93/	P-UB-10	50 mm	80 mm	FD-FP417	42.09
MODEL 655E								
BACKHOE BOOM LIFT	85800200			P-UB-10	63 mm	5-1/8	FD-85802568	134.23
BACKHOE BUCKET	83962129			P-U-10	63 mm	90 mm	FD-85804743	78.52
BACKHOE CROWD	81873434			P-UB-10	63 mm	115 mm	FD-85804742	104.32
BACKHOE H.E.D.	85800700			P-UB-10	50 mm	70 mm	FD-85802569	41.21
BACKHOE STABILIZER	85800600			P-UB-10	56 mm	100 mm	FD-83971999	70.57
BACKHOE SWING	85800300			P-UB-10	50 mm	110 mm	FD-85802570	46.79
LOADER BUCKET	85800500			P-UB-10	40 mm	80 mm	FD-85804740	40.21
LOADER LIFT	85800100			P-UB-10	50 mm	90 mm	FD-85802567	40.53
MODEL 675D								
BACKHOE BUCKET	E7NN-B576-AB		9-92/	P-U-10	63 mm	90 mm	FD-FP456	49.96
BACKHOE CROWD	F1NN-B578-AA		9-92/	P-UB-10	63 mm	115 mm	FD-FP455	66.29
BACKHOE EXTENDABLE DIPSTICK	E7NN-C492-BD		9-92/	P-UB-10	50 mm	80 mm	FD-FP457	36.96
BACKHOE STABILIZER-CENTERPIVOT	F2NN-B580-AA		9-92/	P-UB-10	56 mm	100 mm	FD-FP458	71.56
BACKHOE STABILIZER-SIDESHIFT	E7NN-B580-BA		9-92/8-93	P-UB-10	50 mm	70 mm	FD-FP459	41.24
	E7NN-B580-BB		9-93/	P-UB-10	50 mm	70 mm	FD-FP459	41.24
BACKHOE SWING - CENTER PIVOT	E7NN-B579-AD		9-93/	P-UB-10	50 mm	110 mm	FD-FP460	72.61
	E7NN-B579-BA		9-92/8-93	P-UB-10	50 mm	110 mm	FD-FP460	72.61
BACKHOE SWING - SIDE SHIFT	E7NN-B579-BA		9-92/8-93	P-UB-10	50 mm	110 mm	FD-FP460	72.61
	E7NN-B579-BC		9-93/	P-UB-10	50 mm	110 mm	FD-FP460	72.61
LOADER BUCKET LH	F1NN-L904-AA		9-92/	P-UB-10	40 mm	80 mm	FD-85804740	40.21
LOADER BUCKET RH	F1NN-L903-AA		9-92/	P-UB-10	40 mm	80 mm	FD-85804740	40.21
LOADER BUCKET-MULTIPURPOSE	F1NN-A136-AA		9-92/	P-UB-10	40 mm	70 mm	FD-FP419	43.38
LOADER LIFT	E7NN-L905-BC		4-93/	P-UB-10	50 mm	80 mm	FD-FP417	42.09
MODEL 675E								
BACKHOE BOOM LIFT	85800200			P-UB-10	63 mm	5-1/8	FD-85802568	134.23
BACKHOE BUCKET	83962129			P-U-10	63 mm	90 mm	FD-85804743	78.52

Replacement Kits For

FORD

Loader Backhoes								
APPLICATION	CYL #	Piston Type	SERIAL #	CODE	ROD	BORE	KIT #	List \$
MODEL 675E								
BACKHOE CROWD	81873434			P-UB-10	63 mm	115 mm	FD-85804742	104.32
BACKHOE H.E.D.	85800700			P-UB-10	50 mm	70 mm	FD-85802569	41.21
BACKHOE STABILIZER	85800600			P-UB-10	56 mm	100 mm	FD-83971999	70.57
BACKHOE SWING	85800300			P-UB-10	50 mm	110 mm	FD-85802570	46.79
LOADER BUCKET	85800500			P-UB-10	40 mm	80 mm	FD-85804740	40.21
LOADER LIFT	85800100			P-UB-10	50 mm	90 mm	FD-85802567	40.53
MODEL 730								
LOADER BUCKET				P-V-8	1-1/4	2	FD-309957	18.16
LOADER LIFT				P-V-8	1-1/2	2	FD-309956	26.64
MODEL 740								
LOADER BUCKET				P-V-8	1-1/2	3	FD-309959	31.67
LOADER LIFT				P-V-8	2	3	FD-309960	36.34
MODEL 750								
BACKHOE BUCKET	D5NN-B576-C		11-75/78	P-V-9	2-1/2	4	FD-309970	64.16
BACKHOE CROWD	D7NN-B578-A		11-75/78	P-V-9	2-1/2	5	FD-309962	70.65
BACKHOE LIFT	D7NN-B577-A		11-75/78	P-V-9	2-1/2	5-1/2	FD-309963	75.17
BACKHOE STABILIZER	D7NN-B580-A		11-75/78	P-V-8	2	4-1/2	FD-309941	53.42
BACKHOE SWING	D5NN-B579-D		11-75/78	P-V-9	1-3/4	3-1/2	FD-309950	60.43
LOADER BUCKET	D7NN-L903-A		11-75/78	P-V-9	2-1/4	4	FD-309951	62.26
LOADER HYDRO BUCKET	7708113		11-75/78	P-U-13	2	3	FD-7708145	27.69
LOADER LIFT	D7NN-L905-A		11-75/78	P-V-9	2-1/4	3-3/4	FD-309969	60.43
MODEL 753								
BACKHOE BUCKET					2-1/2	3.52	FD-309949	60.43
BACKHOE CROWD				P-V-9	2	4	FD-309946	70.26
BACKHOE LIFT				P-V-9	2	4	FD-309946	70.26
BACKHOE STABILIZER				P-V-8	1-3/4	4	FD-309940	45.49
BACKHOE SWING				P-V-8	1-3/4	4	FD-309940	45.49
MODEL 755								
BACKHOE BUCKET		2pc			2-1/2	3.52	FD-309949	60.43
	D5NN-B576-C		78/83	P-V-9	2-1/2	4	FD-309970	64.16
BACKHOE CROWD		2pc		P-V-9	2-1/4	4-1/2	FD-309948	65.92
	D7NN-B578-A		78/5-79	P-V-9	2-1/2	5	FD-309962	70.65
	E8NN-B578-AA		6-79/83	P-UV-9	63 mm	125 mm	FD-251160	99.90
BACKHOE LIFT		2pc		P-V-9	2	4-1/2	FD-309947	57.93
	D7NN-B577-A		78/5-79	P-V-9	2-1/2	5-1/2	FD-309963	75.17
	D9NN-B577-AA		6-79/83	P-UV-9	63 mm	150 mm	FD-251159	103.80
BACKHOE STABILIZER		2pc		P-V-8	1-3/4	4	FD-309940	45.49
	D7NN-B580-A		78/83	P-V-8	2	4-1/2	FD-309941	53.42
BACKHOE SWING		2pc		P-V-8	1-3/4	4-1/2	FD-309939	49.00
	D5NN-B579-D		78/83	P-V-9	1-3/4	3-1/2	FD-309950	60.43
LOADER BUCKET	D7NN-L903-A		78/83	P-V-9	2-1/4	4	FD-309951	62.26
LOADER HYDRO BUCKET	7708113		78/83	P-U-13	2	3	FD-7708145	27.69
LOADER LIFT	D7NN-L905-A		78/83	P-V-9	2-1/4	3-3/4	FD-309969	60.43

Replacement Kits For

FORD

FORD

Loader Backhoes								
APPLICATION	CYL #	Piston Type	SERIAL #	CODE	ROD	BORE	KIT #	List \$
MODEL 755A								
BACKHOE BUCKET	D5NN-B576-C		84/5-86	P-V-9	2-1/2	4	FD-309970	64.16
	E5NN-B576-AA		6-86/12-86	P-UV-10	56 mm	100 mm	FD-251315	47.17
BACKHOE CROWD	E8NN-B578-AA		84/86	P-UV-9	63 mm	125 mm	FD-251160	99.90
BACKHOE LIFT	D9NN-B577-AA		84/86	P-UV-9	63 mm	150 mm	FD-251159	103.80
BACKHOE STABILIZER	D7NN-B580-A		84/86	P-V-8	2	4-1/2	FD-309941	53.42
BACKHOE SWING	D5NN-B579-D		83/5-86	P-V-9	1-3/4	3-1/2	FD-309950	60.43
	E6NN-B579-AA		6-86/12-86	P-UV-10	50 mm	110 mm	FD-251303	76.64
LOADER BUCKET	D7NN-L903-A		84/5-86	P-V-9	2-1/4	4	FD-309951	62.26
	E5NN-L903-AA		6-86/12-86	P-UV-10	56 mm	100 mm	FD-251315	47.17
LOADER HYDRO BUCKET	7708113		84/86	P-U-13	2	3	FD-7708145	27.69
LOADER LIFT	D7NN-L905-A		84/5-86	P-V-9	2-1/4	3-3/4	FD-309969	60.43
	E5NN-L905-AA		6-86/12-86	P-UV-10	56 mm	100 mm	FD-251315	47.17
MODEL 755B								
BACKHOE BUCKET	E5NN-B576-AA		87/10-88	P-UV-10	56 mm	100 mm	FD-251315	47.17
	E8NN-B576-AA		11-88	P-UB-10	56 mm	100 mm	FD-FP398	55.89
BACKHOE CROWD	E8NN-B578-AA		87/10-88	P-UV-9	63 mm	125 mm	FD-251160	99.90
	E8NN-B578-AA		11-88/	P-UB-9	63 mm	125 mm	FD-FP528	109.34
BACKHOE EXTENDABLE DIPSTICK	E6NN-C492-AA		5-87/2-89	P-V-10	50 mm	80 mm	FD-251317	72.17
	E7NN-C492-BD		3-89/	P-UB-10	50 mm	80 mm	FD-FP457	36.96
BACKHOE LIFT	D9NN-B577-AA		87/	P-UV-9	63 mm	150 mm	FD-251159	103.80
BACKHOE STABILIZER	D7NN-B580-A		87/10-88	P-V-8	2	4-1/2	FD-309941	53.42
	E8NN-B580-AA		11-88/	P-UB-10	56 mm	115 mm	FD-FP410	53.35
BACKHOE SWING	E6NN-B579-AA		87/10-88	P-UV-10	50 mm	110 mm	FD-251303	76.64
	E7NN-B579-AB		11-88/	P-UB-10	50 mm	110 mm	FD-FP460	72.61
LOADER BUCKET	E5NN-L903-AA		87/10-88	P-UV-10	56 mm	100 mm	FD-251315	47.17
	E8NN-L903-AA		11-88/	P-UB-10	56 mm	100 mm	FD-FP398	55.89
LOADER HYDRO BUCKET	7708113		87/	P-U-13	2	3	FD-7708145	27.69
LOADER LIFT	E5NN-L905-AA		87/10-88	P-UV-10	56 mm	100 mm	FD-251315	47.17
	E8NN-L905-AA		11-88/	P-UB-10	56 mm	100 mm	FD-FP398	55.89
MODEL 5500-5550								
BACKHOE ARM				P-V-9	2-1/2	5	FD-309962	70.65
BACKHOE BUCKET					2-1/2	3.52	FD-309949	60.43
BACKHOE LIFT				P-V-9	2-1/2	5-1/2	FD-309963	75.17
BACKHOE STABILIZER				P-V-8	2	4-1/2	FD-309941	53.42
BACKHOE SWING				P-V-9	1-3/4	3-1/2	FD-309950	60.43
LOADER BUCKET				P-V-9	2-1/2	4	FD-309970	64.16
LOADER LIFT				P-V-9	2-1/4	4	FD-309951	62.26
MODEL 6500								
BACKHOE BUCKET	D5NN-B576-B		73/10-75		2-1/2	3.52	FD-309949	60.43
BACKHOE CROWD	D7NN-B578-B		73/10-75	P-V-9	2-1/4	4-1/2	FD-309948	65.92
BACKHOE LIFT	D7NN-B577-F		73/10-75	P-V-9	2-1/2	5	FD-309962	70.65
BACKHOE STABILIZER	D7NN-B580-C		73/10-75	P-V-8	1-3/4	4	FD-309940	45.49

Replacement Kits For

FORD

Loader Backhoes								
APPLICATION	CYL #	Piston Type	SERIAL #	CODE	ROD	BORE	KIT #	List \$
MODEL 6500								
BACKHOE SWING	D7NN-B579-D		73/10-75	P-V-8	1-3/4	4-1/2	FD-309939	49.00
LOADER BUCKET	D7NN-L903-A		73/10-75	P-V-9	2-1/4	4	FD-309951	62.26
LOADER HYDRO BUCKET	7708113		73/10-75	P-U-13	2	3	FD-7708145	27.69
LOADER LIFT	D7NN-L905-F		73/10-75	P-V-9	2-1/4	4	FD-309951	62.26
MODEL 7500								
BACKHOE BUCKET	D5NN-B576-C		73/10-75	P-V-9	2-1/2	4	FD-309970	64.16
BACKHOE CROWD	D7NN-B578-A		73/10-75	P-V-9	2-1/2	5	FD-309962	70.65
BACKHOE LIFT	D7NN-B577-A		73/10-75	P-V-9	2-1/2	5-1/2	FD-309963	75.17
BACKHOE STABILIZER	D7NN-B580-A		73/10-75	P-V-8	2	4-1/2	FD-309941	53.42
BACKHOE SWING	D5NN-B579-D		73/10-75	P-V-9	1-3/4	3-1/2	FD-309950	60.43
LOADER BUCKET	D7NN-L903-A		73/10-75	P-V-9	2-1/4	4	FD-309951	62.26
LOADER HYDRO BUCKET	7708113		73/10-75	P-U-13	2	3	FD-7708145	27.69
LOADER LIFT	D7NN-L905-A		73/10-75	P-V-9	2-1/4	3-3/4	FD-309969	60.43
MODEL A62								
LOADER BUCKET				P-V-9	2-1/2	5-1/2	FD-309977	82.81
LOADER LIFT				P-V-9	2	4-1/2	FD-309980	63.93
MODEL A64								
LOADER BUCKET				P-V-9	3	6	FD-309978	88.03
LOADER LIFT				P-V-9	2	5	FD-309981	72.26
MODEL A66								
LOADER BUCKET				P-V-9	3	6-1/2	FD-309979	97.05
LOADER LIFT				P-V-9	2-1/2	5-1/2	FD-309963	75.17
Tractors								
APPLICATION	CYL #	Piston Type	SERIAL #	CODE	ROD	BORE	KIT #	List \$
MODEL								
	7102266			N-OB-1	1-1/4		FD-7102289	6.43
	CED2NNC846C			P-OB-10	1-1/4	3	FD-CE41300922	29.75
	CED2NNC846D			P-OB-10	7/8	2	FD-CE41200904	13.12
	D2NN-C846-A			I-U-3	1-3/8	3	FD-DHPNC846A	14.30
	D2NN-C846-B			I-TR-3	1-3/8	3-1/2	FD-DHPNC846D	13.81
	D2NN-C846-C			I-TR-3	1-3/8	3	FD-DHPNC846C	13.11
	D2NN-C846-D			I-TR-3	1	2	FD-DHPNC846B	10.27
	D8NN-C846-AA			I-U-3	1-3/8	3-1/2	FD-PRNPMCKS916	14.49
	MPP20TB08			I-TR-3	1	2	FD-DHPNC846B	10.27
	MPP30TB08			I-TR-3	1-3/8	3	FD-DHPNC846C	13.11
	MPP35TB08			I-TR-3	1-3/8	3-1/2	FD-DHPNC846D	13.81
MODEL 2600, 3600, 4600, 4600-SU								
ACCESSORY	D2NN-C846-B		75/81	I-TR-3	1-3/8	3-1/2	FD-DHPNC846D	13.81
	D2NN-C846-C		75/81	I-TR-3	1-3/8	3	FD-DHPNC846C	13.11
	D2NN-C846-D		75/81	I-TR-3	1	2	FD-DHPNC846B	10.27
MODEL 3400, 3500, 3550, 4400, 4500								
ACCESSORY	7102266		65/74	N-OB-1	1-1/4		FD-7102289	6.43
	D2NN-C846-B		65/74	I-TR-3	1-3/8	3-1/2	FD-DHPNC846D	13.81

Replacement Kits For

FORD**FORD**

Tractors								
APPLICATION	CYL #	Piston Type	SERIAL #	CODE	ROD	BORE	KIT #	List \$
MODEL 3400, 3500, 3550, 4400, 4500								
ACCESSORY	D2NN-C846-C		65/74	I-TR-3	1-3/8	3	FD-DHPNC846C	13.11
	D2NN-C846-D		65/74	I-TR-3	1	2	FD-DHPNC846B	10.27
MODEL 5600								
ACCESSORY	D2NN-C846-A		75/81	I-U-3	1-3/8	3	FD-DHPNC846A	14.30
	D8NN-C846-AA		75/81	I-U-3	1-3/8	3-1/2	FD-PRNPMCKS916	14.49
MODEL 6600, 7600								
ACCESSORY	D2NN-C846-A		75/81	I-U-3	1-3/8	3	FD-DHPNC846A	14.30
	D2NN-C846-B		75/81	I-TR-3	1-3/8	3-1/2	FD-DHPNC846D	13.81
	D2NN-C846-C		75/81	I-TR-3	1-3/8	3	FD-DHPNC846C	13.11
	D2NN-C846-D		75/81	I-TR-3	1	2	FD-DHPNC846B	10.27
	D8NN-C846-AA		75/81	I-U-3	1-3/8	3-1/2	FD-PRNPMCKS916	14.49

REPLACEMENT KITS FOR FORD EQUIPEMENT

Kit Number	Code (Pg. x)	Pist.	Rod X Bore Size	List Price
FD-251032	P-UV-9	2 pc.	63 X 90 mm	\$ 109.50
FD-251033	P-UV-9	2 pc.	63 X 125 mm	105.27
FD-251034	P-UV-9	2 pc.	56 X 115 mm	102.17
FD-251035	P-V-9	2 pc.	50 X 100 mm	157.42
FD-251036	P-UV-9	2 pc.	63 X 115 mm	93.66
FD-251037	P-UV-9	2 pc.	56 X 110 mm	106.80
FD-251038	P-UV-8	2 pc.	50 X 100 mm	56.90
FD-251072	P-UV-8	1 pc.	40 X 70 mm	23.14
FD-251073	P-U-10	1 pc.	40 X 80 mm	33.37
FD-251074	P-U-10	1 pc.	50 X 80 mm	27.52
FD-251074B	P-U-10	1 pc.	50 X 80 mm	42.09
FD-251159	P-UV-9	2 pc.	63 X 150 mm	103.80
FD-251160	P-UV-9	2 pc.	63 X 125 mm	99.89
FD-251162	P-U-10	1 pc.	50 X 70 mm	26.26
FD-251303	P-UV-10	1 pc.	50 X 110 mm	76.64
FD-251315	P-UV-10	1 pc.	56 X 100 mm	47.17
FD-251316	P-UV-10	1 pc.	50 X100 mm	106.04
FD-251317	P-V-10	1 pc.	50 X 80 mm	72.16
FD-251318	P-UV-10	1 pc.	56 X 115 mm	78.58
FD-251319	P-UV-10	1 pc.	63 X 115 mm	82.40
FD-251320	P-UV-10	1 pc.	63 X 125 mm	81.22
FD-251321	P-UV-10	1 pc.	63 X 90 mm	74.00
FD-251339	P-UV-10	2 pc.	50 X 100 mm	70.53
FD-251361	P-U-10	1 pc.	45 X 70 mm	60.38
FD-251362	P-U-10	1 pc.	2 X 3	18.09

Kit Number	Code (Pg. x)	Pist.	Rod X Bore Size	List Price
FD-251363	P-U-10	1 pc.	1-1/2 X 3	\$ 18.74
FD-251369	P-U-10	1 pc.	35 X 60 mm	26.61
FD-251370	P-U-10	1 pc.	40 X 60 mm	29.89
FD-309938	P-V-8	2 pc.	1-3/4 x 3-1/2	52.76
FD-309939	P-V-8	2 pc.	1-3/4 X 4-1/2	49.00
FD-309940	P-V-8	2 pc.	1-3/4 X 4	45.50
FD-309941	P-V-8	2 pc.	2 X 4-1/2	53.41
FD-309945	P-V-9	2 pc.	1-3/4 X 3-1/2	58.78
FD-309946	P-V-9	2 pc.	2 X 4	70.26
FD-309947	P-V-9	2 pc.	2 X 4-1/2	57.93
FD-309948	P-V-9	2 pc.	2-1/4 X 4-1/2	65.92
FD-309949	P-V-9	2 pc.	2-1/2 X 3-1/2	60.43
FD-309950	P-V-9	2 pc.	1-3/4 X 3-1/2	60.43
FD-309951	P-V-9	2 pc.	2-1/4 X 4	62.25
FD-309956	P-V-8	2 pc.	1-1/2 X 2	26.64
FD-309957	P-V-8	2 pc.	1-1/4 X 2	18.16
FD-309959	P-V-8	2 pc.	1-1/2 X 3	31.67
FD-309960	P-V-8	2 pc.	2 X 3	36.34
FD-309962	P-V-9	2 pc.	2-1/2 X 5	70.65
FD-309963	P-V-9	2 pc.	2-1/2 X 5-1/2	75.16
FD-309969	P-V-9	2 pc.	2-1/4 X 3-3/4	60.43
FD-309970	P-V-9	2 pc.	2-1/2 X 4	64.16
FD-309974F	P-V-8	2 pc.	1-1/2 X 3	58.67
FD-309977	P-V-9	2 pc.	2-1/2 X 5-1/2	82.81
FD-309978	P-V-9	2 pc.	3 X 6	88.03

FORD

Kit Number	Code (Pg. x)	Pist.	Rod X Bore Size	List Price
FD-309979	P-V-9	2 pc.	3 X 6-1/2	\$ 97.04
FD-309980	P-V-9	2 pc.	2 X 4-1/2	63.93
FD-309981	P-V-9	2 pc.	2-1/2 X 5.025	72.26
FD-309984	P-U-8	2 pc.	2 X 3.025	30.16
FD-309984F	P-U-8	2 pc.	2 X 3	38.33
FD-309985	P-U-8	2 pc.	1-1/2 X 3.025	29.03
FD-309985F	P-U-8	2 pc.	1-1/2 X 3	38.04
FD-7708145	P-U-13	1 pc.	2 X 3	27.69
FD-83971999	P-UB-10	1 pc.	56 X 100 mm	70.57
FD-85802567	P-UB-10	1 pc.	50 X 90 mm	40.52
FD-85802568	P-UB-10	1 pc.	63 mm X 5.125	134.23
FD-85802569	P-UB-10	1 pc.	50 X 70 mm	41.21
FD-85802570	I-UB-10	1 pc.	50 X 110 mm	46.79
FD-85804740	P-UB-10	1 pc.	40 X 80 mm	40.22
FD-85804741	P-UB-10	1 pc.	63 X 125 mm	94.80
FD-85804742	P-UB-10	1 pc.	63 X 115 mm	104.31
FD-85804743	P-U-10	1 pc.	63 X 90 mm	78.51
FD-FINN3A539AA	I-U-10	1 pc.	40 mm x 2-3/4	26.07
FD-FINN3A539AA	I-U-10	1 pc.	40 mm X 2-3/4	26.07
FD-FP398	P-UB-10	1 pc.	56 X 100 mm	55.88
FD-FP410	P-UB-10	1 pc.	56 X 115 mm	53.35
FD-FP417	P-UB-10	1 pc.	50 X 80 mm	42.09
FD-FP419	P-UB-10	1 pc.	40 X 70 mm	43.39
FD-FP454	P-UB-10	1 pc.	56 x 115 mm	97.67
FD-FP455	P-UB-10	1 pc.	63 x 115 mm	66.29
FD-FP456	P-U-10	1 pc.	63 x 90 mm	49.96
FD-FP457	P-UB-10	1 pc.	50 X 80 mm	36.95
FD-FP458	P-UB-10	1 pc.	56 X 100 mm	71.56
FD-FP459	P-UB-10	1 pc.	50 X 70 mm	41.23
FD-FP460	P-UB-10	1 pc.	50 x 110 mm	72.61
FD-FP528	P-UB-9	1 pc.	63 X 125 mm	109.34



FORD TRACTORS

Kit Number	Code (Pg. x)	Rod X Bore Size	List Price
FD-7102289	N-OB-1	1-1/4 ROD	\$ 6.42
FD-CE41300922	P-OB-1	1-1/4 X 3	29.75
FD-CE41200904	P-OB-1	7/8 X 2	13.12
FD-DHPNC846A	I-U-3	1-3/8 X 3	14.30
FD-DHPNC846D	I-TR-3	1-3/8 X 3-1/2	13.81
FD-DHPNC846C	I-TR-3	1-3/8 X 3	13.11
FD-DHPNC846B	I-TR-3	1 X 2	10.27
FD-PRNPMCKS916	I-U-3	1-3/8 X 3-1/2	14.49

FORD VEE SETS

Part Number	I.D.	O.D.	H.	List Price
FVS12504S079	1-1/4	1-3/4	0.079	\$ 4.57
FVS15004S128	1-1/2	2.000	1.265	6.00
FVS15004U087	1-1/2	2.000	7/8	8.46
FVS22504U087	2-1/4	2-3/4	7/8	9.17
FVS30206S118	2.275	3.025	1-3/16	13.13
FVS25004U087	2-1/2	3.000	7/8	9.01
FVS25004X100	2-1/2	3.000	1.000	10.88
FVS35206S102	2.775	3.525	1.015	13.50
FVS37706D102	3.025	3.775	1.015	14.25
FVS40206D102	3.275	4.025	1.015	21.61
FVS45206D102	3.775	4.525	1.015	22.36
FVS45206S102	3.775	4.525	1.015	21.14
FVS50206D102	4.275	5.025	1.015	19.88
FVS55206D102	4.775	5.525	1.015	21.75
FVS60206D102	5-1/4	6.000	1.015	26.39
FVS65206D102	5-3/4	6-1/2	1.015	31.88

FRANKLIN

Kit Number	Code (Pg. x)	Rod X Bore Size	List Price
FR-1023070	I-U-10	2-1/2 X 5	\$ 31.97
FR-1025526	I-U-10	2-1/2 X 5	30.68
FR-1026526	I-U-10	2-1/2 X 5	29.83
FR-1028996	I-U-10	1-3/4 X 3-1/2	27.63
FR-1028997	I-U-10	3 X 6	40.07
FR-1500328A	P-V-1	1-3/8 ROD	17.50
FR-1500328B	P-V-12	1-3/8 X 3	46.64
FR-1500341	P-V-7	1-3/8 X 3	36.18

FRANKLIN

Kit Number	Code (Pg. x)	Rod X Bore Size	List Price
FR-1500525A	3" PISTON SEAL		\$ 3.31
FR-1500527A	7" PISTON SEAL		7.63
FR-1500568A	P-V-1	1-1/2 ROD	19.59
FR-1500568B	P-V-12	1-1/2 X 3-1/2	42.07
FR-1500893	P-V-10,12	2-1/2 X 4	47.38
FR-1500893A	P-V-10	2-1/2 X 4	25.81
FR-1500893B	P-V-10,12	2-1/2 X 4	39.86
FR-1500900A	P-V-10	1-1/2 X 3-1/2	26.84
FR-1500900B	P-V-10,12	1-1/2 X 3-1/2	42.11
FR-1500921	3" Piston Kit		8.78
FR-1501279	P-V-5	2 X 4-1/2	44.76
FR-1501288	P-V-5	1-1/2 X 3-3/8	37.84
FR-1503650	P-V-12	2 X 3-1/2	45.88
FR-1504074	I-U-5	2-1/2 X 5	39.32
FR-1504160	P-V-7	2-1/2 X 4	43.60
FR-1504353	I-V-12	2 X 4	67.12
FR-1504669	P-V-10,12	2-1/2 X 4	54.40
FR-1504704	P-V-10, 12	1-3/8 X 3	46.43
FR-1504986	I-U-5	2-1/2 X 5	57.63
FR-1505499	I-U-10	2-1/2 X 5	69.09
FR-1505720	I-U-10	2-1/2 X 4	23.01
FR-1505721	I-U-10	2-1/2 X 4	31.41
FR-1505724	I-U-10	1-1/2 X 3	22.63
FR-1505725	I-U-10	4 X 5	37.71
FR-1505727	I-U-10	1-3/4 X 3-1/2	26.34
FR-1505761	P-U-10	1-3/4 X 3-1/2	30.29
FR-1506186	I-U-10	2 X 4	24.31
FR-1507263	I-U-5	4 X 7	52.80
FR-1507265	I-U-5	2 X 3	16.70
FR-1507266	I-U-5	2 X 3-1/2	18.05
FR-1507280	I-U-5	3 X 6	61.70
FR-1507281	I-U-5	3 X 7	45.20
FR-1507282	I-U-5	3 X 6	38.65
FR-1507283	I-U-5	1-1/2 X 3-1/2	17.26
FR-1507284	I-U-5	1-1/2 X 3	15.77
FR-H22/32/42	I-U-4	1-3/8 X 3-1/4	17.37

FRUEHAUF BOTTOM DUMP AIR CYLINDERS

Kit Number	Code (Pg. x)	Rod X Bore Size	List Price
FRU-D10252	I-V-5	1-5/8 X 7	\$ 52.50
FRU-D1052	I-V-5	1-5/8 X 6	49.81
FRU-HLA96845	I-V, U-5	1-5/8 X 6	51.91
FRU-HLA96855	I-V,U-5	1-5/8 X 7	54.86
FRU-HMD	I-U-11	1-1/2 X 3	17.17

FURUKAWA

Kit Number	Code (Pg. x)	Rod X Bore Size	List Price
FUR-341541-99110	P-U-5	40 X 80	\$ 90.90
FUR-341831-99110	P-U-5	65 X 140	87.85
FUR-341831-99120	I-U-5	55 X 110	74.28

GALBREATH ROLL-OFF

Kit Number	Code (Pg. x)	Rod X Bore Size	List Price
GLB-1110	I-U-12	4-1/2 X 6	\$ 92.07
GLB-2473	I-U-12	3 X 7	73.28
GLB-3135	I-U-1	3 Rod Kit	18.68

GALION-DRESSER

Kit Number	Description	List Price
GD-D48664	5-1/2" Double Acting Vee Set	\$ 12.35
GD-D50182	3-1/2" Double Acting Vee Set	30.61
GD-D63806	11-1/4" X 12 Vee Set	120.72

GARWOOD

Kit Number	Code (Pg. x)	Rod X Bore Size	List Price
GW-2044692K	I-V-5	2 X 7	\$ 41.03
GW-2061839K	I-V-5	1-3/4 X 4	32.44
GW-2061841K	I-V-1	3-1/8, 4-1/2, 5-3/4 Stgs	80.05
GW-2064753K	I-V-1	4, 5, 6 Stages	56.56
GW-2064754K	I-V-1	5, 6, 7 Stages	68.03
GW-2064755K	I-V-1	4, 5, 6, 7 Stages	83.10
GW-2069544K	I-TR-1	2-1/2, 3-1/4 Stages	18.20
GW-2072369	I-U-5	2-1/2 X 5	41.77
GW-2073610K	N-U-4	3-1/2 X 4	26.40
GW-2074132K	I-U-5	3-1/2 X 5	34.62
GW-2074169K	I-U-1	3-1/2, 4-1/2, 5-1/2 Stgs	45.61
GW-2074235K	N-N-4	3" Bore	14.16
GW-2074467K	I-U-5	2-1/2 X 5	31.70
GW-2079197K	I-U-5	3-1/2 X 5	36.97

Replacement Kits For

GEHL

Forklifts							
APPLICATION	CYL #	SERIAL #	CODE	ROD	BORE	KIT #	List \$
MODEL 552, 553							
ATTACHMENT ROTATE	L63594		I-U-10	1	2-1/2	GEHL-L99170	25.55
ATTACHMENT SLAVE	L63014		I-U-11	1-3/4	3-1/2	GEHL-L98527	23.61
ATTACHMENT TILT	L63013		I-U-11	2	4	GEHL-L98548	41.42
BOOM EXTEND	L63012		I-U-11	2-1/2	3-1/2	GEHL-L98558	45.51
BOOM LIFT	L63199		I-U-11	2-1/2	4-1/2	GEHL-L98521	41.44
FORK SHIFT	L66920		I-U-10	1-1/4	2	GEHL-L99958	51.02
FRAME LEVEL	L63015		I-U-11	1-3/4	4	GEHL-L98506	31.04
STEER	L98444		I-U-10	45 mm	90 mm	GEHL-L98565	78.95
MODEL 663							
BOOM EXTEND	L64333		I-U-10	3	4	GEHL-L99386	50.68
BOOM LIFT	L64014		I-U-10	3	4	GEHL-L99331	73.89
CARRIER SLAVE	L61869		I-U-10	1-3/4	3-1/2	GEHL-L99332	41.93
CARRIER TILT	L61868		I-U-10	2	4	GEHL-L99385	62.01
FRAME SWAY	L64054	PRIOR-4319	I-U-10	3	4	GEHL-L97674	46.74
	L64085	4320-4356	P-U-5	1-3/4	4	GEHL-L97903	42.58
	L64818	4357-UP	I-U-10	1-3/4	4	GEHL-L99382	50.15
ROTATE CARRIAGE	L61317		I-U-10	1-3/8	3	GEHL-L97769	31.09
STEER	L97649- L97976		I-U-10	1-1/8	2-1/4	GEHL-L97978	24.84
MODEL 883							
ATTACHMENT TILT	L49988A	7001-7004	I-U-10	2-1/2	5	GEHL-L97716	58.24
	L64086	7005-7444	P-U-10	2-1/2	5	GEHL-L97922	47.44
	L66665	7445-UP	I-U-11	2-1/2	5	GEHL-L99377	66.19
BOOM EXTEND	L64385	7001-7004	I-U-10	3-1/2	4-1/2	GEHL-L97713	51.35
	L66770	7446-UP	I-U-10	3-1/2	4-1/2	GEHL-L99376	58.83
BOOM LIFT	L64083	7005-7445	I-U-10	3-1/2	4-1/2	GEHL-L97908	34.72
	L64401	7001-7004	I-U-10	3-1/2	4-1/2	GEHL-L97711	42.81
	L66821	7446-UP	I-U-10	3-1/2	4-1/2	GEHL-L99329	74.14
BOOM SLAVE	L64087	7005-7171	I-U-10	2-1/4	4-1/2	GEHL-L97715	36.17
	L64087	7001-7004	I-U-10	2-1/4	4-1/2	GEHL-L97917	42.03
	L66032	7172-7444	I-U-10	2-1/4	4-1/2	GEHL-L97917	42.03
	L66666	7445-UP	I-U-11	2-1/4	5	GEHL-L99330	58.04
FORK SHIFT	L66920		I-U-10	1-1/4	2	GEHL-L99958	51.02
FRAME LEVEL	L64085	7005-7445	P-U-5	1-3/4	4	GEHL-L97903	42.58
	L64818	7001-7004, 7446-UP	I-U-10	1-3/4	4	GEHL-L99382	50.15
MAST LIFT	L66537		I-U-10	2	3	GEHL-L98848	23.32
OUTRIGGER	L64968	PRIOR-7386	I-U-10	2-1/2	4	GEHL-L97938	28.15
	L66642	7387-UP	I-U-11	2-1/2	4	GEHL-L99059	39.91
ROTATE CARRIAGE	L61317		I-U-10	1-3/8	3	GEHL-L97769	31.09
STEER	L97649		I-U-10	1-1/8	2-1/4	GEHL-L97978	24.84
	L99428		I-U-10	1-1/8	3	GEHL-L99430	28.29
SWING CARRIAGE	L63970	2781-UP	I-U-10	1-1/4	2-1/2	GEHL-L99944	25.09
	L65659	PRIOR-2780	I-U-10	1-3/8	3	GEHL-L97955	39.78

GEHL

Kit Number	Code (Pg. x)	Rod X Bore Size	List Price
GEHL-L97674	I-U-10	3 X 4	\$ 46.74
GEHL-L97711	I-U-10	3-1/2 X 4-1/2	42.81
GEHL-L97713	I-U-10	3-1/2 X 4-1/2	51.35
GEHL-L97715	I-U-10	2-1/4 X 4-1/2	42.03
GEHL-L97716	I-U-10	2-1/2 X 5	58.24
GEHL-L97769	I-U-10	1-3/8 X 3	31.09
GEHL-L97903	P-U-5	1-3/4 X 4	42.58
GEHL-L97908	I-U-10	3-1/2 X 4-1/2	34.72
GEHL-L97917	I-U-10	2-1/4 X 4-1/2	36.17
GEHL-L97922	P-U-10	2-1/2 X 5	47.44
GEHL-L97938	I-U-10	2-1/2 X 4	28.15
GEHL-L97955	I-U-10	1-3/8 X 3	39.78
GEHL-L97978	I-U-10	1-1/8 X 2-1/4	24.84
GEHL-L98506	I-U-11	1-3/4 X 4	31.04
GEHL-L98521	I-U-11	2-1/2 X 4-1/2	41.44
GEHL-L98527	I-U-11	1-3/4 X 3-1/2	23.61
GEHL-L98548	I-U-11	2 X 4	41.42
GEHL-L98558	I-U-11	2-1/2 X 3-1/2	45.51
GEHL-L98565	I-U-10	45 X 90 mm	78.95
GEHL-L98848	I-U-10	2 X 3	23.32
GEHL-L99059	I-U-11	2-1/2 X 4	39.91
GEHL-L99170	I-U-10	1 X 2-1/2	25.55
GEHL-L99329	I-U-10	3-1/2 X 4-1/2	74.14
GEHL-L99330	I-U-11	2-1/4 X 5	58.04
GEHL-L99331	I-U-10	3 X 4	73.89

GEHL

Kit Number	Code (Pg. x)	Rod X Bore Size	List Price
GEHL-L99332	I-U-10	1-3/4 X 3-1/2	\$ 41.93
GEHL-L99376	I-U-10	3-1/2 X 4-1/2	58.83
GEHL-L99377	I-U-11	2-1/2 X 5	66.19
GEHL-L99382	I-U-10	1-3/4 X 4	50.15
GEHL-L99385	I-U-10	2 X 4	62.01
GEHL-L99386	I-U-10	3 X 4	50.68
GEHL-L99430	I-U-10	1-1/8 X 3	28.29
GEHL-L99944	I-U-10	1-1/4 X 2-1/2	25.09
GEHL-L99958	I-U-10	1-1/4 X 2	51.02

GLENCOE

Kit Number	Code (Pg. x)	Rod X Bore Size	List Price
GLC-TH200B-K	I-TR-1	2-1/2, 2-7/8, 3-3/8 Stages	\$ 32.87
GLC-TH80	I-TR-1	2-3/8, 2-7/8 Stages	19.75
GLC-UA80568	I-TR-1	2-7/8, 3-3/8 Stages	25.96
GLC-UA80569	I-TR-1	2-3/8, 2-7/8, 3-3/8 Stages	32.82
GLC-UA80570	I-TR-1	2-3/8, 2-7/8, 3-3/8, 3-7/8 Stgs	48.60
GLC-UA80589	I-TR-1	2-7/8, 3-3/8, 3-7/8 Stages	39.47

**KINGSEAL CO., LTD. THAILAND**

46/152-153 Moo 3 Sri Saman Road
Baan Mai Pakkret, Nonthaburi Thailand 11120

Tel: +662 9617534 to 6

Fax: +662 9617540

Email: intlsales@kingseal.co.th / kingsealmail@gmail.com

Website: <http://www.kingseal.co.th>

Replacement Kits For

GRADALL

GRADALL

Rough Terrain Forklifts							
APPLICATION	CYL #	SERIAL #	CODE	ROD	BORE	KIT #	List \$
MODEL 532C-6							
COMPENSATING	9112-3049	0188002-UP	I-U-10	3-1/8	6-1/4	GRD-91124049	37.10
CROWD	9112-3009	0188002-UP	P-U-10	2-1/2	3-1/2	GRD-91124044	23.63
	9112-5024	0188153-UP	P-U-14	2-1/2	3-1/2	GRD-91123080	83.27
LIFT(IOWA)	9112-3111	0288940H-0388020H	P-U-10	3	5-1/2	GRD-91124071	63.95
	9112-3111	0288695-0288715	P-U-10	3	5-1/2	GRD-91124071	63.95
	9112-3111	0288587, 0288692	P-U-10	3	5-1/2	GRD-91124071	63.95
LIFT(SEITZ)	9112-3010	0288588-0288691	P-U-10	3	5-1/2	GRD-91124036	33.77
	9112-3010	0288693, 0288694	P-U-10	3	5-1/2	GRD-91124036	33.77
	9112-3010	0288716-0288939	P-U-10	3	5-1/2	GRD-91124036	33.77
	9112-3010	0188002-0288586	P-U-10	3	5-1/2	GRD-91124036	33.77
STEERING(IOWA)	9108-3467	0288587, 0288692	P-UB-10	1-1/4	2-1/2	GRD-91084305	35.51
	9108-3467	0288940H-0388020H	P-UB-10	1-1/4	2-1/2	GRD-91084305	35.51
	9108-3467	0288695-0288715	P-UB-10	1-1/4	2-1/2	GRD-91084305	35.51
STEERING(SEITZ)	9108-3281	0288716-0288939	P-U-10	1-1/4	2-1/2	GRD-91084183	16.83
	9108-3281	0288693, 0288694	P-U-10	1-1/4	2-1/2	GRD-91084183	16.83
	9108-3281	0288588-0288691	P-U-10	1-1/4	2-1/2	GRD-91084183	16.83
	9108-3281	0188002-0288586	P-U-10	1-1/4	2-1/2	GRD-91084183	16.83
SWAY(IOWA)	9108-3471	0288695-0288715	P-UB-10	2	3-1/2	GRD-91084308	56.84
	9108-3471	0288587, 0288692	P-UB-10	2	3-1/2	GRD-91084308	56.84
	9108-3471	0288940H-0388020H	P-UB-10	2	3-1/2	GRD-91084308	56.84
SWAY(SEITZ)	9108-3286	0288588-0288691	P-U-10	2	3-1/2	GRD-91084189	18.57
	9108-3286	0288693, 0288694	P-U-10	2	3-1/2	GRD-91084189	18.57
	9108-3286	0288716-0288939	P-U-10	2	3-1/2	GRD-91084189	18.57
	9108-3286	0188002-0288586	P-U-10	2	3-1/2	GRD-91084189	18.57
TILT	9112-3067	0188002-UP	P-U-10	2-1/2	5	GRD-91034278	27.05
MODEL 534B-6							
COMPENSATING	9103-3288	0144293H-UP	P-U-10	2-1/2	5	GRD-91034150	32.04
CROWD	9080-1293	8344001L-UP	I-U-10	2-1/2	4	GRD-90208023	32.55
CROWD(IOWA)	9103-3290	0144293H-UP	P-U-10	2-1/2	4	GRD-91034223	29.08
LIFT	9080-1333	8344001L-UP	I-U-10	2-1/2	5	GRD-90207953	25.65
LIFT(IOWA)	9103-3286	0144293H-UP	P-U-10	2-1/2	5	GRD-91034140	32.29
STEERING	9045-3034	FOR SERVICE	P-UB-10	1-1/2	3	GRD-91144006	35.03
STEERING(IOWA)	9103-3291	0144293H-UP	P-U-10	1-1/2	3	GRD-91034145	22.48
STEERING(JARP)	9080-1313	8344001L-UP	I-U-10	1-1/2	3	GRD-90202551	12.55
SWAY	9080-1270	8344001L-8644030G	I-U-10	2	4	GRD-90201553	20.34
	9104-3139	8644031G-UP	I-U-10	2	4	GRD-91044205	16.41
SWAY(IOWA)	9104-3205	0144293H-UP	P-U-10	2	4	GRD-91044275	27.11
TILT	9080-1292	8344001L-8344011L	I-U-10	2	4	GRD-90201553	20.34
	9080-1357	8344012L-8744136G	I-U-10	2-1/2	4	GRD-91034049	21.87
TILT COMP	9080-1291	8344001L-8344011L	I-U-10	2	4	GRD-90201553	20.34
	9080-1356	8344012L-8744136G	I-U-10	2-1/2	4	GRD-91034049	21.87
TILT COMP(JARP)	9080-1328	8744142G-UP	I-U-10	2-1/2	5	GRD-90207954	23.20
TILT(IOWA)	9103-3287	0144293H-UP	P-U-10	2-1/2	5	GRD-91034150	32.04
TILT(JARP)	9080-1327	8744142G-UP	I-U-10	2-1/2	5	GRD-90207954	23.20
MODEL 534B-8							
COMPENSATING	9103-3288	0144293H-UP	P-U-10	2-1/2	5	GRD-91034150	32.04
CROWD	9080-1293	8344001L-UP	I-U-10	2-1/2	4	GRD-90208023	32.55
CROWD(IOWA)	9103-3290	0144293H-UP	P-U-10	2-1/2	4	GRD-91034223	29.08

Replacement Kits For

GRADALL

GRADALL

Rough Terrain Forklifts							
APPLICATION	CYL #	SERIAL #	CODE	ROD	BORE	KIT #	List \$
MODEL 534B-8							
LIFT	9080-1180	8344001L-UP	I-U-10	2-1/2	4-1/2	GRD-90207956	21.97
LIFT(IOWA)	9103-3286	0144293H-UP	P-U-10	2-1/2	5	GRD-91034140	32.29
STEERING	9045-3034	FOR SERVICE	P-UB-10	1-1/2	3	GRD-91144006	35.03
STEERING(IOWA)	9103-3291	0144293H-UP	P-U-10	1-1/2	3	GRD-91034145	22.48
STEERING(JARP)	9080-1313	8344001L-UP	I-U-10	1-1/2	3	GRD-90202551	12.55
SWAY	9080-1270	8344001L-8644030G	I-U-10	2	4	GRD-90201553	20.34
	9104-3139	8644031G-UP	I-U-10	2	4	GRD-91044205	16.41
SWAY(IOWA)	9104-3205	0144293H-UP	P-U-10	2	4	GRD-91044275	27.11
TILT COMP(JARP)	9080-1328	8344001L-UP	I-U-10	2-1/2	5	GRD-90207954	23.20
TILT(IOWA)	9103-3287	0144293H-UP	P-U-10	2-1/2	5	GRD-91034150	32.04
TILT(JARP)	9080-1327	8344001L-UP	I-U-10	2-1/2	5	GRD-90207954	23.20
MODEL 534B-9							
COMPENSATING	9104-3304	0144860S-UP	P-U-10	2-1/2	5	GRD-91034278	27.05
CROWD	9103-3368	0144860S-UP	P-U-10	2-1/2	4	GRD-91034290	24.19
LIFT	9103-3371	0144860S-UP	P-U-10	2-1/2	5	GRD-91034278	27.05
STEERING	9103-3478	0244089S-UP	P-U-10	1-1/2	3	GRD-91034301	23.26
	9104-3316	0144860S-UP	P-U-10	1-1/2	3	GRD-91034301	23.26
SWAY	9103-3367	0144860S-UP	P-U-10	2	4	GRD-91034297	21.28
TILT	9103-3369	0144860S-UP	P-U-10	2-1/2	5	GRD-91034278	27.05
MODEL 534C-6							
COMPENSATING(IOWA)	9108-3470	0288940H-0388020H	P-UB-10	2-1/2	5	GRD-91034339	52.32
	9108-3470	0288695-0288715	P-UB-10	2-1/2	5	GRD-91034339	52.32
	9108-3470	0288587, 0288692	P-UB-10	2-1/2	5	GRD-91034339	52.32
COMPENSATING(SEITZ)	9108-3285	0288693, 0288694	P-U-10	2-1/2	5	GRD-91084169	24.05
	9108-3285	0188002-0288586	P-U-10	2-1/2	5	GRD-91084169	24.05
	9108-3285	0288588-0288691	P-U-10	2-1/2	5	GRD-91084169	24.05
	9108-3285	0288716-0288939	P-U-10	2-1/2	5	GRD-91084169	24.05
CROWD	9112-3009	0188002-UP	P-U-10	2-1/2	3-1/2	GRD-91124044	23.63
	9112-5024	0188153-UP	P-U-14	2-1/2	3-1/2	GRD-91123080	83.27
LIFT(IOWA)	9112-3111	0288587, 0288692	P-U-10	3	5-1/2	GRD-91124071	63.95
	9112-3111	0288940H-0388020H	P-U-10	3	5-1/2	GRD-91124071	63.95
	9112-3111	0288695-0288715	P-U-10	3	5-1/2	GRD-91124071	63.95
LIFT(SEITZ)	9112-3010	0288716-0288939	P-U-10	3	5-1/2	GRD-91124036	33.77
	9112-3010	0288693, 0288694	P-U-10	3	5-1/2	GRD-91124036	33.77
	9112-3010	0188002-0288586	P-U-10	3	5-1/2	GRD-91124036	33.77
	9112-3010	0288588-0288691	P-U-10	3	5-1/2	GRD-91124036	33.77
STEERING(IOWA)	9108-3467	0288695-0288715	P-UB-10	1-1/4	2-1/2	GRD-91084305	35.51
	9108-3467	0288940H-0388020H	P-UB-10	1-1/4	2-1/2	GRD-91084305	35.51
	9108-3467	0288587, 0288692	P-UB-10	1-1/4	2-1/2	GRD-91084305	35.51
STEERING(SEITZ)	9108-3281	0288716-0288939	P-U-10	1-1/4	2-1/2	GRD-91084183	16.83
	9108-3281	0188002-0288586	P-U-10	1-1/4	2-1/2	GRD-91084183	16.83
	9108-3281	0288693, 0288694	P-U-10	1-1/4	2-1/2	GRD-91084183	16.83
	9108-3281	0288588-0288691	P-U-10	1-1/4	2-1/2	GRD-91084183	16.83
SWAY(IOWA)	9108-3471	0288695-0288715	P-UB-10	2	3-1/2	GRD-91084308	56.84
	9108-3471	0288587, 0288692	P-UB-10	2	3-1/2	GRD-91084308	56.84
	9108-3471	0288940H-0388020H	P-UB-10	2	3-1/2	GRD-91084308	56.84
SWAY(SEITZ)	9108-3286	0188002-0288586	P-U-10	2	3-1/2	GRD-91084189	18.57
	9108-3286	0288588-0288691	P-U-10	2	3-1/2	GRD-91084189	18.57

Replacement Kits For

GRADALL

Rough Terrain Forklifts

APPLICATION	CYL #	SERIAL #	CODE	ROD	BORE	KIT #	List \$
MODEL 534C-6							
SWAY(SEITZ)	9108-3286	0288693, 0288694	P-U-10	2	3-1/2	GRD-91084189	18.57
	9108-3286	0288716-0288939	P-U-10	2	3-1/2	GRD-91084189	18.57
TILT(IOWA)	9108-3472	0288587, 0288692	P-UB-10	2	4	GRD-91034337	37.75
	9108-3472	0288695-0288715	P-UB-10	2	4	GRD-91034337	37.75
TILT(SEITZ)	9108-3472	0288940H-0388020H	P-UB-10	2	4	GRD-91034337	37.75
	9108-3379	0188002-0288586	P-U-10	2	4	GRD-91034297	21.28
	9108-3379	0288716-0288939	P-U-10	2	4	GRD-91034297	21.28
	9108-3379	0288588-0288691	P-U-10	2	4	GRD-91034297	21.28
	9108-3379	0288693, 0288694	P-U-10	2	4	GRD-91034297	21.28

GRADALL

Kit Number	Code (Pg. x)	Rod X Bore Size	List Price
GRD-90201553	I-U-10	2X4	\$ 20.34
GRD-90202551	I-U-10	1-1/2X3	12.55
GRD-90207953	I-U-10	2-1/2X5	25.65
GRD-90207954	I-U-10	2-1/2X5	23.20
GRD-90207956	I-U-10	2-1/2X4-1/2	21.97
GRD-90208023	I-U-10	2-1/2X4	32.55
GRD-91034049	I-U-10	2-1/2X4	21.87
GRD-91034140	P-U-10	2-1/2X5	32.29
GRD-91034145	P-U-10	1-1/2X3	22.48
GRD-91034150	P-U-10	2-1/2X5	32.04
GRD-91034223	P-U-10	2-1/2X4	29.08
GRD-91034278	P-U-10	2-1/2X5	27.05
GRD-91034290	P-U-10	2-1/2X4	24.19
GRD-91034297	P-U-10	2X4	21.28
GRD-91034301	P-U-10	1-1/2X3	23.26
GRD-91034337	P-UB-10	2X4	37.75
GRD-91034339	P-UB-10	2-1/2X5	52.32
GRD-91044205	I-U-10	2X4	16.41
GRD-91044275	P-U-10	2X4	27.11
GRD-91044335	I-U-11, 12	2-1/2 X 5	64.23

Kit Number	Code (Pg. x)	Rod X Bore Size	List Price
GRD-91084169	P-U-10	2-1/2X5	\$ 24.05
GRD-91084183	P-U-10	1-1/4X2-1/2	16.83
GRD-91084189	P-U-10	2X3-1/2	18.57
GRD-91084305	P-UB-10	1-1/4X2-1/2	35.51
GRD-91084308	P-UB-10	2X3-1/2	56.84
GRD-91123080	P-U-14	2-1/2X3-1/2	83.27
GRD-91124036	P-U-10	3X5-1/2	51.69
GRD-91124044	P-U-10	2-1/2X3-1/2	23.63
GRD-91124049	I-U-10	3-1/8X6-1/4	37.10
GRD-91124071	P-UB-10	3X5-1/2	63.95
GRD-91144006	P-UB-10	1-1/2X3	49.28



Replacement Kits For

GROVE CRANE

GROVE CRANE

Rough Terrain Cranes					
APPLICATION	CODE	ROD	BORE	KIT #	List \$
MODEL RT58B, RT58C, RT58D					
BOOM LIFT	I-U-11	3-5/8	8-1/4	GC9752100164	165.51
BOOM TELE	I-U-11	4-1/2	6-1/2	GC9752100232	103.75
EXTENSION	I-U-11	3-5/8	7	GC9752100329	144.71
STABILIZER	I-U-11	3-5/8	7	GC9752100329	144.71
SWIVEL	SWIVEL		7-1/2	GC9752100358	59.42
MODEL RT60S					
BOOM LIFT	I-U-10	3-1/2	8-1/4	GC9752100027	35.33
BOOM TELE	I-U-11	3	4	GC9752100114	35.58
	I-U-11	3-5/8	5	GC9752100076	76.69
EXTENSION	I-U-11	1-3/4	3	GC9752100072	39.12
STABILIZER	I-U-11	3-5/8	5	GC9752100076	76.69
SWIVEL	SWIVEL		3-3/4	GC9752100303	27.58
	SWIVEL		8-1/4	GC9752100302	182.34
MODEL RT515, RT518, RT525, RT527					
BOOM LIFT	I-U-11	3-5/8	9	GC9752100199	172.31
BOOM TELE	I-U-11	5	6-1/2	GC9752100238	117.65
EXTENSION	I-U-11	1-3/4	3	GC9752100072	39.12
STABILIZER	I-U-11	4	5-1/2	GC9752100240	135.42
SWIVEL	SWIVEL		5-1/2	GC9752100312	52.44
	SWIVEL		8-1/2	GC9752100311	117.98
Truck Mounted Crane					
APPLICATION	CODE	ROD	BORE	KIT #	List \$
MODEL TM150, TM155					
BOOM LIFT	I-U-11	3-5/8	8-1/4	GC9752100074	90.65
	I-U-10	3-1/2	8-1/4	GC9752100027	35.33
BOOM TELE	I-U-11	3-5/8	5	GC9752100034	42.29
	I-U-11	2-5/8	4	GC9752100035	32.64
EXTENSION	I-U-11	1-3/4	3	GC9752100072	39.12
	I-U-10	1-3/4	3	GC9752100019	19.97
STABILIZER	I-U-10	3-5/8	5	GC9752100008	36.99
MODEL TM180					
BOOM LIFT	I-U-10	3-1/2	8-1/4	GC9752100027	35.33
BOOM TELE	I-U-11	3	4	GC9752100114	35.58
	I-U-11	3-5/8	5	GC9752100076	76.69
	I-U-11	2-5/8	4	GC9752100075	53.16
EXTENSION	I-U-11	1-3/4	3	GC9752100072	39.12
STABILIZER	I-U-11	3-5/8	5	GC9752100076	76.69
MODEL TM250					
BOOM LIFT	I-U-11	6	10	GC9752100029	138.69
BOOM TELE	I-U-11	5-1/2	7	GC9752100193	111.43
EXTENSION	I-U-11	1-3/4	3	GC9752100072	39.12
JACK	I-U-11	3-5/8	5	GC9752100229	112.15
STABILIZER	I-U-11	3-5/8	5	GC9752100229	112.15
SWIVEL	SWIVEL		8-1/2	GC9752100314	194.15
	SWIVEL		8-1/2	GC9752100306	81.06
MODEL TM300					
BOOM LIFT	I-U-10	6-1/2	8-1/4	GC9752100146	166.32
BOOM TELE	I-U-11	4-1/2	5-1/2	GC9752100157	92.34

Replacement Kits For

GROVE CRANE

GROVE CRANE

Truck Mounted Crane					
APPLICATION	CODE	ROD	BORE	KIT #	List \$
MODEL TM300					
EXTENSION	I-U-11	1-3/4	3	GC9752100072	39.12
JACK	I-U-11	3-5/8	5	GC9752100229	112.15
STABILIZER	I-U-11	4-3/4	6	GC9752100162	90.25
SWIVEL	SWIVEL		8-1/2	GC9752100314	194.15
MODEL TM400					
BOOM LIFT	I-U-10	6-1/2	12-1/2	GC9752100039	141.41
BOOM TELE	I-U-11	4-1/2	6	GC9752100077	61.43
	I-U-11	3-5/8	5	GC9752100076	76.69
EXTENSION	I-U-11	1-3/4	3	GC9752100072	39.12
STABILIZER	I-U-10	4-1/2	7-1/2	GC9576100048	33.76
MODEL TM475					
BOOM TELE	I-U-11	4-1/2	5-1/2	GC9752100202	131.14
EXTENSION	I-U-11	1-3/4	3	GC9752100072	39.12
JACK	I-U-11	3-5/8	5	GC9752100229	112.15
STABILIZER	I-U-11	4-3/4	6	GC9752100162	90.25
SWIVEL	SWIVEL		8-1/2	GC9752100314	194.15
MODEL TM750E					
BOOM TELE	I-U-11	5	6	GC9752100293	157.89
EXTENSION	I-U-11	1-3/4	3	GC9752100369	40.13
JACK	I-U-11	3-5/8	5	GC9752100364	98.87
STABILIZER	I-U-11	4-3/4	6	GC9752100163	85.20
SWIVEL	SWIVEL		5-1/2	GC9752100300	21.27
MODEL TM800					
EXTENSION	I-U-11	5-1/2	6-1/2	GC9752100090	100.48
MODEL TM870E					
BOOM LIFT	I-U-11	7	10	GC9752100286	258.29
EXTENSION	I-U-11	1-3/4	3	GC9752100072	39.12
JACK	I-U-11	4-3/4	6	GC9752100163	85.20
STABILIZER	I-U-11	4-3/4	6	GC9752100163	85.20
SWIVEL	SWIVEL		5-1/2	GC9752100300	21.27
MODEL TMS250EB					
BOOM LIFT	I-U-11	6	10	GC9752100029	138.69
BOOM TELE	I-U-11	5-1/2	7	GC9752100193	111.43
EXTENSION	I-U-11	1-1/2	2-1/2	GC9752100363	29.80
JACK	I-U-11	3-5/8	5	GC9752100364	98.87
STABILIZER	I-U-11	4	5-1/2	GC9752100387	124.35
SWIVEL	SWIVEL		8-1/2	GC9752100306	81.06
	SWIVEL		8-1/2	GC9752100538	230.02
MODEL TMS275					
BOOM LIFT	I-U-11	6	10	GC9752100029	138.69
BOOM TELE	I-U-11	3-5/8	5	GC9752100076	76.69
EXTENSION	I-U-10	1-3/4	3	GC9752100009	19.84
STABILIZER	I-U-10	3-1/2	5-7/8	GC9372100153	46.87

REPLACEMENT KITS FOR GROVE CRANE

GROVE CRANE

Kit Number	Code (Pg. x)	Rod X Bore Size	List Price
GC360006321	I-OB-4	2-1/2 X 4-1/2	\$ 24.04
GC6576000014	I-U-10	2-5/8 X 4	25.91
GC9372100153	I-U-10	3-1/2 X 5-7/8	46.87
GC9372100165	I-U-10	6 X 11	94.59
GC9372101365	I-U-4	2-1/2 X 4-1/2	25.16
GC9576000014	I-U-10	2-5/8 X 4	23.53
GC9576100016	P-U-5	3-5/8 X 5	118.76
GC9576100048	I-U-10	4-1/2 X 7-1/2	33.76
GC9752100002	I-U-10	2-5/8 X 5	31.12
GC9752100003	I-U-10	1-1/4 X 3	12.32
GC9752100004	I-U-10	2-5/8 X 7	44.17
GC9752100008	I-U-10	3-5/8 X 5	36.99
GC9752100009	I-U-10	1-3/4 X 3	19.84
GC9752100019	I-U-10	1-3/4 X 3	19.97
GC9752100027	I-U-10	3-1/2 X 8-1/4	35.33
GC9752100029	I-U-10	6 X 11	138.69
GC9752100032	I-U-10	2-5/8 X 4	27.43
GC9752100034	N-U-11	3-5/8 X 5	42.29
GC9752100035	I-U-11	2-5/8 X 4	32.64
GC9752100039	I-U-10	6-1/2 X 12-1/2	141.41
GC9752100072	I-U-11	1-3/4 X 3	39.12
GC9752100074	I-U-13	3-5/8 X 8-1/4	90.65
GC9752100075	I-U-11	2-5/8 X 4	53.16
GC9752100076	I-U-11	3-5/8 X 5	76.69
GC9752100077	I-U-11	4-1/2 X 6	61.43
GC9752100079	I-U-11	2-5/8 X 5	64.30
GC9752100081	I-U-11	3-5/8 X 7	85.99
GC9752100082	I-U-11	2-5/8 X 7	82.07
GC9752100083	I-U-11	3-5/8 X 6	79.75
GC9752100085	I-U-11	2 X 4	43.41
GC9752100090	I-U-11	5-1/2 X 6-1/2	100.48
GC9752100111	I-U-11	4-3/4 X 6	93.61
GC9752100112	I-U-11	5-1/2 X 7	113.84
GC9752100114	I-U-11	3 X 4	35.58
GC9752100115		EXTENSION LINE KIT	28.75
GC9752100116		O-RING KIT	4.27
GC9752100117		O-RING KIT	25.56
GC9752100119		TUBE EXTENSION KIT	33.58
GC9752100121		O-RING KIT	5.31
GC9752100123	N-U-4	5/8 X 1-7/8	10.64

Kit Number	Code (Pg. x)	Rod X Bore Size	List Price
GC9752100127	I-U-11	6 X 10	\$ 198.22
GC9752100137	I-U-10	6 X 10	201.34
GC9752100138	I-U-13	7 X 11	327.29
GC9752100146	I-U-10	6-1/2 X 8-1/4	166.32
GC9752100150	I-U-11	6 X 7	138.38
GC9752100152	I-U-10	7 X 11	206.76
GC9752100157	I-U-11	4-1/2 X 5-1/2	92.34
GC9752100160		O-RING KIT	4.39
GC9752100161		O-RING KIT	4.06
GC9752100162	I-U-11	4-3/4 X 6	90.25
GC9752100163	I-U-11	4-3/4 X 6	85.20
GC9752100164	I-U-11	3-5/8 X 8-1/4	165.51
GC9752100167	I-U-11	6 X 7	119.74
GC9752100168	I-U-11	5-1/2 X 7	149.64
GC9752100173	I-U-11	5-1/2 X 6-1/2	171.25
GC9752100180	I-U-11	6 X 8-1/4	148.40
GC9752100181	I-U-11	7 X 8-1/4	253.76
GC9752100182		VALVE KIT	6.31
GC9752100184	I-U-13	7 X 11	244.55
GC9752100184U	I-U-13	7 X 11 UNIV. KIT	340.21
GC9752100186	I-U-11	6 X 10	251.94
GC9752100187	I-U-11	3-5/8 X 6	94.51
GC9752100189	I-U-11	4-1/2 X 6	90.64
GC9752100192	I-U-11	6 X 10	314.34
GC9752100193	I-U-11	5-1/2 X 7	111.43
GC9752100198	I-U-11	7 X 11	322.77
GC9752100199	I-U-11	3-5/8 X 9	172.31
GC9752100202	I-U-11	4-1/2 X 5-1/2	131.14
GC9752100229	I-U-11	3-5/8 X 5	112.15
GC9752100232	I-U-11	4-1/2 X 6-1/2	103.75
GC9752100234	I-U-11	4-1/2 X 6	104.38
GC9752100235	I-U-11	2-5/8 X 5	67.44
GC9752100236	I-U-11	3-5/8 X 8-1/4	144.75
GC9752100238	I-U-11	5 X 6-1/2	117.65
GC9752100239	I-U-11	4 X 5-1/2	118.47
GC9752100240	I-U-11	4 X 5-1/2	135.42
GC9752100241	I-U-11	3-5/8 X 5	92.14
GC9752100242	I-U-11	2-5/8 X 5	93.46
GC9752100243	I-U-11	5-1/2 X 7	193.91
GC9752100267		O-RING KIT	2.97

GROVE CRANE

Kit Number	Code (Pg. x)	Rod X Bore Size	List Price
GC9752100286	I-U-11	7 X 10	\$ 258.29
GC9752100290	I-U-11	6 X 9	244.43
GC9752100293	I-U-11	5 X 6	157.89
GC9752100298		7-1/2" SWIVEL KIT	97.75
GC9752100299		6" SWIVEL KIT	52.04
GC9752100300		5-1/2" SWIVEL KIT	21.27
GC9752100301		8-1/2" SWIVEL KIT	168.00
GC9752100302		8-1/4" SWIVEL KIT	182.34
GC9752100303		3-3/4" SWIVEL KIT	27.58
GC9752100306		8-1/2" SWIVEL KIT	81.06
GC9752100307		8-1/2" SWIVEL KIT	140.24
GC9752100311		8-1/2" SWIVEL KIT	117.98
GC9752100312		5-1/2" SWIVEL KIT	52.44
GC9752100314		8-1/2" SWIVEL KIT	194.15
GC9752100324	I-U-10	1-3/4 X 3	47.25
GC9752100328		VALVE KIT	6.68
GC9752100329	I-U-11	3-5/8 X 7	144.71
GC9752100345	I-U-11	4-1/2 X 5-1/2	104.64
GC9752100358		7-1/2" SWIVEL KIT	59.42
GC9752100361		7" SWIVEL KIT	82.16
GC9752100363	I-U-13	1-1/2 X 2-1/2	29.80
GC9752100364	I-U-11	3-5/8 X 5	98.87
GC9752100369	I-U-11	1-3/4 X 3	40.13
GC9752100377	I-U-11	3 X 4-1/2	66.59
GC9752100385		5-1/2" SWIVEL KIT	53.05
GC9752100387	I-U-11	4 X 5-1/2	124.35
GC9752100391		Valve Kit	4.45
GC9752100445	I-U-11	6 X 9	248.63
GC9752100461	I-U-11	3-5/8 X 5	126.54
GC9752100463	I-UB-11	7 X 9	309.54

GROVE CRANE

Kit Number	Code (Pg. x)	Rod X Bore Size	List Price
GC9752100466		EXTENSION LINE KIT	\$ 34.73
GC9752100467	I-U-11	3-5/8 X 7	157.54
GC9752100468	I-U-11	3-5/8 X 5	116.35
GC9752100470	I-UB-11	5 X 8-1/4	201.45
GC9752100475	I-U-11	7 X 9	267.71
GC9752100477	I-U-11	3 X 5-1/2	88.51
GC9752100491	I-U-11	3-5/8 X 8-1/4	145.75
GC9752100498		EXTENSION LINE KIT	26.03
GC9752100532	I-UB-9	5 X 6	330.99
GC9752100538		8-1/2" SWIVEL KIT	230.02
GC9752100563		5-1/2" SWIVEL KIT	53.05
GC9752101126		8-1/2" SWIVEL KIT	317.67

HARSH MFG.

Kit Number	Code (Pg. x)	Rod X Bore Size	List Price
HM-A9112	I-OB-1	1-7/8 X 2-1/4	\$ 2.04
HM-A9114	I-OB-1	2-7/8" ROD	6.55
HM-A9115	I-OB-1	3-3/8" ROD	6.36
HM-A9116	I-OB-1	3-7/8" ROD	7.87



Replacement Kits For

HEIL

HEIL

Refuse Collectors								
APPLICATION	CYL #	SERIAL #	CODE	ROD	BORE	KIT #	MISC	List \$
MODEL Formula 7000								
BODY HOIST	1-6191	405 - UP	I-U-4	3-1/4, 4	STAGES	HL-K272-4893		101.02
GRABBER	1-4327	405 - UP	I-V-12	1-1/2	3	HL-K272-981		42.19
	1-4843	405 - UP	I-V-12	1-1/2	3	HL-K272-981		42.19
LIFT	1-4338	405 - UP	I-V-12	1-1/2	3	HL-K272-981		42.19
PACKER	1-4298	1 to 447	I-U-10	4	5-1/2	HL-K272-989		46.13
	1-4878	448 - UP	I-U-10	4	5-1/2	HL-K272-989		46.13
REACH	1-4276	405 - UP	I-V-12	1-1/2	3	HL-K272-981		42.19
TAILGATE	1-4305	405 - UP	I-V-10	1-1/2	3	HL-K272-966		22.41
MODEL Half Pak III Full Eject								
LIFT ARM	1-5150	3105106 - UP	P-UB-14	2-1/2	4-1/2	HL-K272-3605		88.04
MODEL Rapid Rail Auto-Side Loader 10/94 - 6/98								
ARM	1-6404		P-UB-14	2	3	HL-1-6404-100		73.09
BODY RAISE	1-4807	To 1837	I-U-1	3-1/4, 4	STAGES	HL-1-4807-100	2 Stage	42.79
	1-6191	1838-UP	I-U-4	3-1/4, 4	STAGES	HL-K272-4893	2 Stage	101.02
DUMP	1-6160		I-UB-4	1-1/8	3	HL-1-6160-100		42.79
DUMP & GRAB	1-6407		P-UB-14	1-1/8	3	HL-1-6402-100		75.00
GRIP	1-6330	To 0329	I-UB-4	1-1/8	2-1/2	HL-K272-6627		41.87
	1-6331	0330 - UP	I-UB-4	1-1/8	3	HL-1-6160-100		42.79
IN-OUT	1-6162		I-UB-14	1-1/8	1-3/4	HL-1-6194-100		58.78
	1-6403		I-UB-14	1-1/8	1-3/4	HL-1-6403-100		76.96
LIFT	1-6161		I-UB-4	2	3	HL-1-6161-100		53.66
PACKER	1-6164		I-UB-4	1-1/2	5	HL-1-6164-100		42.59
	1-6406		P-UB-14	1-1/2	5	HL-1-6406-100		102.56
TAILGATE	1-6405		P-UB-10	1-1/8	3	HL-1-6405-100		36.89
TAILGATE RAISE	1-6163		I-UB-4	1-1/8	3	HL-1-6160-100		42.79
Refuse Rear Loaders								
APPLICATION	CYL #	SERIAL #	CODE	ROD	BORE	KIT #	MISC	List \$
MODEL Formula 4000 MK IV								
EJECTOR	1-4050		I-V-12	2,3,4,5	STAGES	HL-K272-933	18 & 20 yds, Narrow Units	97.52
	1-4050		I-V-12	2,3,4,5	STAGES	HL-K272-933	20 yd	97.52
	1-4053		I-V-12	2,3,4,5	STAGES	HL-K272-933	16 & 18 yds, Narrow Units	97.52
	1-4053		I-V-12	2,3,4,5	STAGES	HL-K272-933	18 yd	97.52
	1-4054		I-V-12	2,3,4,5	STAGES	HL-K272-933	25 yd, Narrow Units	97.52
	1-4054		I-V-12	2,3,4,5	STAGES	HL-K272-933	25 yd	97.52
	1-6222		I-U-12			HL-K272-4885	11 & 13 yds	260.23
	1-6223		I-U-12			HL-K272-4885	11 & 13 yds, Narrow Units	260.23
MODEL Formula 5000 MK V								
EJECTOR	1-4261, 63132-DA		I-V-12	4,5,6	STAGES	HL-K272-976	25 yd	189.57
	1-4266, 63108-DA		I-V-12	4,5,6	STAGES	HL-K272-976	20 yd	189.57
INSIDE LOWER PANEL	1-4343	3722 - UP	I-U-1	4,5,6,7	STAGES	HL-K272-2774	32 yd	247.74
	1-4887	2740 - 6845	I-V-10, 12	3-1/2	5-1/2	HL-K272-2776		47.28

Replacement Kits For

HEIL

Refuse Rear Loaders

APPLICATION	CYL #	SERIAL #	CODE	ROD	BORE	KIT #	MISC	List \$
MODEL Formula 5000 MK V								
OUTSIDE UPPER PANEL	1-4824, 1-4884	2740 - 6845	I-V-10	2-1/2	5	HL-K272-2778		43.45
PACKER BLADE	1-4884		I-V-10	2-1/2	5	HL-K272-2778	Outside Cylinder	43.45
	1-4887		I-V-10, 12	3-1/2	5-1/2	HL-K272-2776	Inside Cylinder	47.28
REAVING	1-6160	5008725 - UP	I-UB-4	1-1/8	3	HL-1-6160-100		42.79

HEIL REPAIR KITS

Kit Number	Cyl. # or Description	Code (Pg. x)	Rod X Bore Size	List Price
HL-1-3688-06	1-3688	I-V-12	5, 6, 7, 8, 9-1/8 Stages	\$ 971.35
HL-1-3689-22	1-3689	I-V-12	4, 5, 6, 7, 8, 9-1/8 Stgs.	1053.25
HL-1-3690-09	1-3690, 1-3691	I-V-10	4 X 6	35.39
HL-1-3692-07	1-3692, 1-3695, 1-3717, 1-3719	I-U-10	1-1/2 X 2-1/2	8.18
HL-1-3693-09	1-3693	I-V-10	2-1/2 X 5	23.28
HL-1-3706-05	1-3705, 1-3706	I-V-10	4 X 6	47.94
HL-1-4098K	1-4098	I-V-10	2-1/2 X 7-1/2	44.51
HL-1-4181-16	1-4181	I-U-5	4 X 4-1/2	38.76
HL-1-4807-100		I-U-1	3-1/4 X 4	42.79
HL-1-5098K	1-5098	P-UB-14	2-1/2 X 4-1/2	84.50
HL-1-5110-10	1-5110	P-UB-14	2-1/2 X 5	89.51
HL-1-6070K	1-6070	P-UB-14,12	1-1/2 X 3	74.67
HL-1-6085-1K	1-6085	P-UB-12,14	1-1/2 X 3	103.22
HL-1-6160-100	1-6160, 1-6163, 1-6331	1-UB-4	1-1/8 X 3	42.79
HL-1-6161-100	1-6161	1-UB-4	2 X 3	53.66
HL-1-6164-100	1-6164	1-UB-4	1-1/2 X 5	42.59
HL-1-6194-100	1-6162	I-UB-14	CYL #1-6162	58.78
HL-1-6402-100	1-6407	P-UB-14	1-1/8 X 3	75.00
HL-1-6403-100	1-6403	P-UB-14	1-1/8 X 1-3/4	76.96
HL-1-6404-100	1-6404	P-UB-14	2 X 3	73.09
HL-1-6405-100	1-6405	P-UB-10	1-1/8 X 3	36.89
HL-1-6406-100	1-6406	P-UB-14	1-1/2 X 5	102.56
HL-6403-34	A1D 3705, 3706	I-V-10	4 X 6	48.94
HL-A1C2819K	A1D 2819	P-V-12	4-1/2 X 6-1/2	153.38
HL-A1D1275-2K	A1D 1275-2K	I-V-1	3-1/2" Rod	31.86
HL-A1D1276K	A1D 1276	I-V-1	2, 3-1/2 Stages	50.74
HL-A1D1285K	A1D 1285	I-V-1	2-3/8 Rod	15.17
HL-A1D1868K	HH30 REEVING CYL.	I-V-12	3-1/2 X 5	106.37
HL-A1D2105K	A1D 2105	N-V-12	1-1/2 X 3	24.52
HL-A1D2801K	A1D 2801	I-V-1	3-1/2 Rod	17.84
HL-A1D2844K	A1D 2844	P-V-12	2-3/4 X 5-1/2	51.24
HL-A1D2847-1	A1D 2847	I-V-1	3-1/2 Rod	22.91
HL-A1D2928K	A1D 2928	I-V-12	2 X 4-1/2	27.28
HL-A1D3503K	A1D 3503	I-V-1	3-1/2 Rod	17.42
HL-A1D3523K	A1D 3523	I-V-1	2, 3-1/2 Stages	31.42
HL-A1D3541-14	LOAD LUGGER	I-U-10	4 X 4-1/2	29.55
HL-A1D3672K	A1D 3672K	I-V-10, 12	2-1/4 X 3-1/2	28.59

HEIL REPAIR KITS

HEIL

Kit Number	Cyl. # or Description	Code (Pg. x)	Rod X Bore Size	List Price
HL-A1D3809K	3809	I-U-10	2 X 4-1/2	\$ 36.27
HL-A1D3856K	A1D 3856	I-U-1	2-1/4 X 3-1/2	17.66
HL-A1D3874K	A1D 3874	I-V-1	3-1/2 Rod	14.29
HL-A1D3917	A1D 3917	I-V-10	3-1/2 X 5	44.56
HL-K22-3132	A1D 3606	I-U-10,12	1-1/2 X 3	16.05
HL-K252-9310	AIE 2125, Mack MX-35, Hoist LIT-72-64	I-V-12	4-3/4, 6-1/4 Stages	195.02
HL-K252-9312	AIE 2108, Mack MX-65, Hoist LIT 92-75	I, P-V-12	6-1/4, 8-5/8 Stages	272.16
HL-K272-1024	1-4854, 1-4137, 1-4138, 1-4139, 1-4140	I-V-1	3-1/8, 4, 5 Stages	50.45
HL-K272-1026	1-4141, 1-4142, 1-4143, 1-4144	I-V-1	4,5,6 Stages	63.82
HL-K272-1027	1-4141, 1-4142, 1-4143, 1-4144	I-V-1	4,5,6 Stages	90.39
HL-K272-2771	1-4344	I-V-10,12	2 X 5	71.44
HL-K272-2774	1-4343	I-U-1	4, 5, 6, 7 Stages	247.74
HL-K272-2775	1-4345	I-V-10, 12	2 X 4	46.66
HL-K272-2776	1-4347, 1-4887	I-V-10, 12	3-1/2 X 5-1/2	47.28
HL-K272-2778	1-4824, 1-4884	I-V-10	2-1/2 X 5	43.45
HL-K272-2880	1-4467	I-U-1	4, 5 Stages	74.54
HL-K272-2924	VALVE KIT			6.22
HL-K272-3334	1-4149	I-V-10	3-1/2 X 5	48.52
HL-K272-3572	1-4849	I-V-12	3-1/2 X 4	43.99
HL-K272-3581	1-4882	I-V-10	4 X 5-1/2	40.45
HL-K272-3582	1-4868, 1-4902, 1-4903, 1-6126	I-V-10	2 X 4	32.83
HL-K272-3583	1-4869	I-V-10	3-1/2 X 5	54.37
HL-K272-3584	1-4871	I-V-10, 12	2-1/2 X 4-1/2	44.52
HL-K272-3586	1-4876	I-U-5	1-1/2 X 2-1/8	18.91
HL-K272-3594	1-5088	P-UB-10	1-3/4 X 3	36.16
HL-K272-3595	1-5082	P-UB,12, 14	2 X 4	109.04
HL-K272-3600	1-5112, 1-5147	I, P-V, UB-14	3, 4, 5 Stages	418.70
HL-K272-3605	1-5150	P-UB-14	2-1/2 X 4-1/2	88.04
HL-K272-3607	1-5146	P-UB-14	4 X 5-1/2	125.55
HL-K272-3608	1-5110	P-UB-14	2-1/2 X 5	89.51
HL-K272-3609	1-5111	P-UB-14	3-1/2 X 5-1/2	135.09
HL-K272-3991	1-4821, 1-4270	I-V-12	4, 5, 6, 7 Stages	274.53
HL-K272-4285		I-V-1	4, 5, 6 Stages	108.36
HL-K272-4456		I-U-10	2 X 6	48.76
HL-K272-4872	TELE. MRK-CYL#50009-53-189		3",4", 5"	396.44
HL-K272-4884	1-6224, 1-6225, 1-6226	I-U-12		395.91
HL-K272-4885	1-6222, 1-6223	I-U-12		260.23
HL-K272-4893	1-6191, 1-4807	I-U-4	3-1/4 X 4	101.02
HL-K272-4932	A1E4159	I-U-1	3-1/8, 4, 5 Stages	102.82
HL-K272-4933	1-4137, 1-4138, 1-4139, 1-4140, A1D-4437	I-V-1	3-1/8, 4, 5 Stages	89.73
HL-K272-4938		I-U-1	4, 5, 6 Stages	122.96
HL-K272-4939	WIPERS,U-SEALS,GLAND & PISTON BEARINGS	4, 5, 6 Stages		137.09
HL-K272-659	A1D 3873	I-V-12	2, 3-1/2 Stages	49.75
HL-K272-660	A1D 3923	I-V-10	3-1/2 X 5	56.81
HL-K272-661	A1D 3924	I-V-10	3-1/2 X 5-1/2	52.77
HL-K272-662	1-3623, AID 3605	I-U-1	2-1/2 X 3	18.20
HL-K272-6627		1-UB-4	1-1/8 X 2-1/2	41.87
HL-K272-6627	1-6330	I-UB-4	1-1/8 X 2-1/2	41.87

HEIL REPAIR KITS

Kit Number	Cyl. # or Description	Code (Pg. x)	Rod X Bore Size	List Price
HL-K272-663	A1D 3513	I-V-1	1-1/2" ROD	\$ 15.73
HL-K272-664	A1D 3921	I-U-10	2 X 4-1/2	33.59
HL-K272-665	A1D 3902, 1-4017	I-U-10	2-1/4 X 3-1/2	30.74
HL-K272-666	4 STAGE EJECTOR	I-V-12	2, 3, 4, 5 Stages	102.44
HL-K272-667	A1D 3904	I-U-10	2-3/4 X 5-1/2	53.89
HL-K272-668	A1D 3903	I-U-10	3-1/2 X 5	50.00
HL-K272-669	A1D 3802	I-U-1	3-1/2 X 4	19.73
HL-K272-672	A001-3807	I-U-10	2-1/4 X 5-1/2	38.34
HL-K272-673	A001-3531	I-U-10	1-1/2 X 3	27.31
HL-K272-674	A001-3525	I-U-10	2 X 4	29.44
HL-K272-676	A1D3835	I-V-12	2, 3, 4 Stages	77.16
HL-K272-677			2, 3, 4 Bearing Kit	69.36
HL-K272-933	1-4050, 1-4053, 1-4054	I-V-12	2, 3, 4, 5 Stages	97.52
HL-K272-934	1-4052	I-V-12	2, 3, 4 Stages	71.23
HL-K272-937	1-4820, 1-4070	I-V-1	2-1/2 X 3	17.55
HL-K272-938	1-4272, 1-4348, 1-4880	I-V-1	3-1/2 X 4	22.03
HL-K272-939	TAILGATE CYL.	I-V-12	2-1/2 X 3	29.21
HL-K272-941	1-4081	I-U-10,12	2-3/4 X 5-1/2	78.84
HL-K272-944	A1D 4100	I-V-10	2-1/4 X 3-1/2	22.92
HL-K272-945	A1D 4101	I-V-10	2 X 4-1/2	27.67
HL-K272-946	A1D 4092	I-N-4	1-3/4 X 3	11.98
HL-K272-948	A1D 4093, 1-4340	I-V-10, 12	2-1/2 X 5	81.09
HL-K272-949	A1D 4094	I-V-10, 12	3 X 5	82.68
HL-K272-950	1-4097	I-V-10, 12	3 X 4-1/2	54.78
HL-K272-951		I-V-10	2-1/2 X 7-1/2	45.40
HL-K272-953	A1D 4103	I-V-10	3-1/2 X 5	60.45
HL-K272-954	A1D 4104	I-V-10	3-1/2 X 5-1/2	34.00
HL-K272-955	A1D 4106	I-V-10, 12	2, 3-1/2 Stages	80.02
HL-K272-956	A1D 4108	I-V-10, 12	2-1/2 X 4	45.82
HL-K272-956A	A1D 4108	I-V-10	2-1/2 X 4	45.82
HL-K272-957	A1D 4110	I-V-10, 12	2 X 4-1/2	66.07
HL-K272-957A	A1D 4110	I-V-10	2 X 4-1/2	66.07
HL-K272-958	1-4339, 1-4105, 1-4264	I-U-10	1-1/2 X 2-1/2	22.60
HL-K272-959	1-4341, 1-4864	I-V-10	2 X 4	31.52
HL-K272-962	A001 - 4114	I-V-12	1-1/2 X 3	32.20
HL-K272-963	1-4265	I-V-10, 12	2-1/4 X 5-1/2	98.96
HL-K272-966	1-4305, 1-4283, 1-4870	I-V-10	1-1/2 X 3	22.41
HL-K272-969		I-V-10	3-1/2 X 5	31.61
HL-K272-971	1-4134	I-V-12	3, 4 Stages	108.77
HL-K272-974		I-U-10	2 X 4	32.32
HL-K272-976	1-4261, 1-4266, 1-4267	I-V-12	4, 5, 6 Stages	189.57
HL-K272-980		N-N-12	4" Piston Ring Kit	19.85
HL-K272-981	1-4883, 1-4276, 1-4338, 1-4327	I-V-12	1-1/2 X 3	42.19
HL-K272-983		I-U-5	4 X 4-1/2	62.73
HL-K272-989	1-4309, 1-4298, 1-4878, 1-6061, 1-6189	I-U-10	4 X 5-1/2	46.13
HL-K272-994	1-4328, 1-4330	I-V-10	4 X 6	34.68

REPLACEMENT CYLINDERS FOR HEIL HPT SERIES DUMP BODIES

Our Company Part Number	Original Part Number	Changed To	Changed To	Changed To	Current Part Number
HPT53100	A1D1972	A1D3140	A1D3887	A1E3983	A1-4137
HPT53110	A1D1766	A1D3141	A1D3888	A1E3984	A1-4138
HPT53120	A1D1973	A1D3058	A1D3889	A1E3985	A1-4139
HPT53130	A1D1974	A1D3139	A1D3890	A1E3986	A1-4140
HPT63120	A1D2043	A1D3177	A1D3891	A1E3998	A1-4141
HPT63130	A1D2044	A1D3178	A1D3892	A1E3999	A1-4142
HPT63140	A1D2298	A1D3179	A1D3893	A1E4000	A1-4143
HPT63160	A1D2624	A1D3180	A1D3180	A1E3180	A1-4144

HEIL REPLACEMENT PARTS FOR DOUBLE ACTING AND SINGLE ACTING TELESCOPIC CYLINDERS

NOTE: The following parts and kits are for the old style Heil telescopic cylinders with vee packing and spiral retainer rings.

- PACKING:** Vee packing with no adaptors.
- WIPERS:** Some cylinders used bronze wipers trapped between the gland collar and the top bearing. Some cylinders used "AN" wipers which snap into a groove in the gland collar.
- BEARINGS:** Cast iron that serve as top and bottom adaptors for vee packing.
- STAGE O.D.'s:** 3-1/8 (3/16" C.S), 4, 5, 6, (1/4" C.S.)
- SPECIAL INFO.:** Uses one spiral type retainer ring per stage as internal stop. Gland collars have 2 "ears" cast 180° apart.
- IDENTIFICATION:** Metal tag attached to cylinder body with model/part number.
Example: AID3140

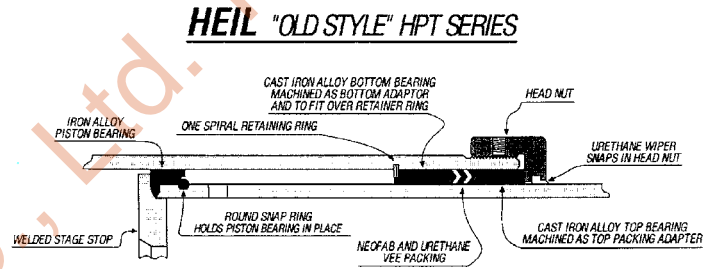

Part Number	Description	List Price
HL26B2090-2A	2" VEE SET & WIPER	\$ 8.78
HL26B2090-3A	3" VEE SET & WIPER	9.62
HL26B2266-1A	3-1/8" VEE SET & WIPER	16.17
HL26B2260-1A	4" VEE SET & WIPER	17.57
HL26B2260-2A	5" VEE SET & WIPER	25.32
HL26B2260-3A	6" VEE SET & WIPER	33.75
HL26A2083-1	2" SPIRAL RETAINER	3.50
HL26A2083-2	3" SPIRAL RETAINER	6.46
HL26A2240-1	3-1/8" SPIRAL RETAINER	11.98
HL26A2083-3	4" SPIRAL RETAINER	7.19
HL26A2083-4	5" SPIRAL RETAINER	6.54
HL26A2406-1	6" SPIRAL RETAINER	17.42
HL26A2080	2" PISTON RING	7.59
HL26A2081	3" PISTON RING	8.00
HL26A2082	4" PISTON RING	9.07
HL26B2221	5" PISTON RING	12.49
HL-26A4149	4-1/2" PISTON SEAL	16.14

Part Number	Description	List Price
HL-24	2" - 4" VEE SETS W/ WIPERS	\$ 34.27
HL-25	2" - 5" VEE SETS W/ WIPERS	57.46
HL-35	3-1/8" - 5" VEE SETS W/ WIPERS	55.32
HL-46	4" - 6" VEE SETS W/ WIPERS	72.07

The following kits contain packing, wiper, top & bottom bearings & spiral snap ring.

Kit Number	Stage O.D.	List Price
HL-2PBTK	2"	\$ 34.47
HL-3.12PBTK	3-1/8"	38.68
HL-3PBTK	3"	37.28
HL-4PBTK	4"	44.27
HL-5PBTK	5"	59.29
HL-6PBTK	6"	69.98
HL-24PBTK	2" - 4"	116.03
HL-25PBTK	2" - 5"	175.30
HL-35PBTK	3-1/8" - 5"	142.11
HL-46PBTK	4" - 6"	173.55

HEIL REPLACEMENT PARTS FOR SINGLE ACTING DUMP TRUCK CYLINDERS

NOTE: The following parts and kits are for the old style Heil telescopic cylinders with vee packing and spiral retainers rings.

HEIL "NEW STYLE" HPT SERIES

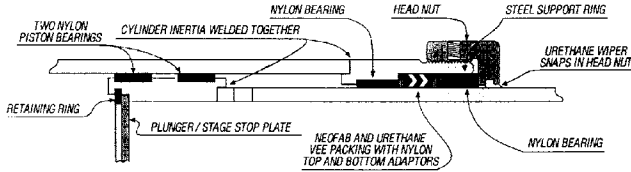

PACKING: Vee packing with nylon top and bottom adaptors.
WIPERS: AN Style
BEARINGS: Split 1/8" thick nylon wear rings.
STAGE O.D's: 3-1/8, 4, 5, 6
SPECIAL INFO.: Has welded stop in gland. Cylinder disassembles by removing large Tru-Arc type snap ring which retains the cylinder base and bottom of each stage.
IDENTIFICATION: Metal tag attached to cylinder body with model/part number.
 Example: AIE3938

Part Number	Description	List Price
HL26-4157-3	5" ID UPPER WEAR RING	\$ 3.35
HL26-4157-4	6" ID UPPER WEAR RING	3.70
HL26-4176-4	6-1/2" OD LOWER WEAR RING	3.95
HL26-4394-1	3-1/8" ID UPPER WEAR RING	4.01
HL26-4394-2	4" ID UPPER WEAR RING	3.35
HL26-4395-1	3-1/2" OD LOWER WEAR RING	4.05
HL26-4395-2	4-1/2" OD LOWER WEAR RING	3.43
HL26-4395-3	5-1/2" OD LOWER WEAR RING	3.42
HL-K272-1024	3-1/8" - 5" PACKING, WIPERS, O-RING	50.45
HL-K272-1026	4" - 6" PACKING, WIPERS, O-RING	63.82
HL-K272-1027	4" - 6" PACKING, WIPERS, WEAR RINGS	90.39

HEIL "NEW STYLE" HPT SERIES

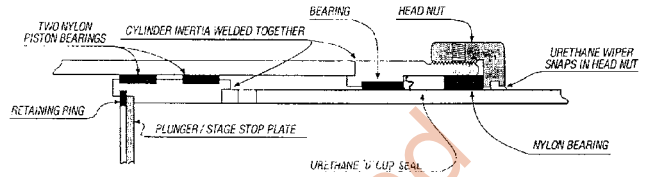

PACKING: Urethane U-Seals
WIPERS: AN Style
BEARINGS: Nylon bearings above and below U-Seal
STAGE O.D's: 3-1/8, 4, 5, 6
SPECIAL INFO.: Welded stop in gland. Tru-Arc type snap ring which retains the cylinder base and bottom of each stage.
IDENTIFICATION: Metal tag attached to cylinder body with model/part number.
 Example: AIE4159

Part Number	Description	List Price
HL-K272-4932	3-1/8, 4, 5" stages - U-seals, wipers, gland bearing, quattro rings, nylon slug, set screw	\$102.82
HL-K272-4938	4, 5, 6" stages - U-seals, wipers, gland bearings, quattro ring, nylon slug, set screw	122.96
HL-K272-4939	4, 5, 6" stages - U-seals, wipers, bearings, quattro ring, nylon slug, set screw	137.09

HEIL SPECIAL HEIL TELESCOPIC VEE SETS

Part Number	Size	List Price
HL26A2038	2-1/2 X 2-7/8	\$ 5.25
HL26A2039	3-1/4 X 3-5/8	6.23
HL26A2215	1-3/4 X 2-1/8	3.71
HL26B2191-2	6-1/4 X 6-3/4	42.95
HL26B2202-1H	2 X 3 W/WIPER	18.69

Part Number	Size	List Price
HL26B2203-1H	3-1/2 X 5 W/WIPER	\$ 39.00
HL26B2482-1	8-5/8 X 9-5/16	75.58
HL26B2484-1	6-1/4 X 7-5/16	69.36
HL30004X182	3 X 3-1/2 X 1.825	40.91
HL40004X184	4 X 4-1/2 X 1.845	55.07

Replacement Kits For

HIAB

HIAB

Cranes								
APPLICATION	CYL #	SERIAL #	CODE	ROD	BORE	KIT #	MISC	List \$
MODEL 045								
1ST EXTENSION			P-U-15	40 mm	55 mm	HIAB-542121		34.62
2ND & 3RD EXT.			P-U-15	30 mm	50 mm	HIAB-542130		31.33
INNER BOOM			P-U-15	50 mm	90 mm	HIAB-542105		38.58
LONG OUTRIGGER			P-U-15	50 mm	70 mm	HIAB-542156		45.13
OUTER BOOM			P-U-15	50 mm	90 mm	HIAB-542113		38.58
SWING			I-N-15	N/A	100 mm	HIAB-542148		63.07
MODEL 070								
BOOM EXT			P-U-13	33 mm	60 mm	HIAB-330-0897		21.30
	AW		P-U-13	35, 82 mm	60, 92 mm	HIAB-330-0731	2-stage Telescopic	103.41
INNER BOOM			P-U-13	90 mm	125 mm	HIAB-330-0871		100.95
OUTER BOOM			P-U-13	70 mm	100 mm	HIAB-330-0889		57.66
MODEL 071								
BOOM EXT	3400441		P-U-13	35, 82 mm	60, 92 mm	HIAB-330-0731		103.41
	3478378		I-U-15	50 mm	80 mm	HIAB-330-1044		30.24
	3501515		I-U-15	50 mm	80 mm	HIAB-330-1044		30.24
	3509052		P-U-13	35, 82 mm	60, 92 mm	HIAB-330-0731		103.41
INNER BOOM	3554589		P-U-13	90 mm	125 mm	HIAB-330-0871		100.95
OUTER BOOM	3300889		P-U-13	70 mm	100 mm	HIAB-330-0889		57.66
OUTRIGGER	3502414		P-U-15	70 mm	90 mm	HIAB-330-1028		33.78
MODEL 100								
BOOM EXT	A		P-SP-15	45 mm	70 mm	HIAB-330-0714		32.51
INNER BOOM			I-SP-15	80 mm	125 mm	HIAB-330-0692		55.12
MODEL 1165								
INNER BOOM			I-SP-15	80 mm	140 mm	HIAB-622-1688		63.37
OUTER BOOM			I-SP-15	80 mm	140 mm	HIAB-622-1688		63.37
MODEL 1165/1								
BOOM EXT	A		I-U-15	50 mm	80 mm	HIAB-330-1044		30.24
	AW	TO 1977	P-U-13	40, 90 mm	70, 105 mm	HIAB-330-0668	2-Stage Telescopic	104.73
INNER BOOM			I-U-13	80 mm	140 mm	HIAB-330-1036		82.75
OUTER BOOM			I-U-13	80 mm	140 mm	HIAB-330-1036		82.75
MODEL 1165/2								
BOOM EXT	3407110		P-U-13	40, 90 mm	70, 105 mm	HIAB-330-0668		104.73
	3430405		I-U-13	33 mm	60 mm	HIAB-330-1001		19.55
	6215645		I-U-15	50 mm	80 mm	HIAB-330-1044		30.24
INNER BOOM	3445038		I-SP-15	80 mm	140 mm	HIAB-622-1688		63.37
OUTER BOOM	3445852		I-SP-15	80 mm	140 mm	HIAB-622-1688		63.37
MODEL 120								
BOOM EXT			P-U-15	45 mm	63 mm	HIAB-330-1311		26.62
			P-U-15	40 mm	63 mm	HIAB-330-1320	Updated Version	29.82
OUTER BOOM			P-U-15	90 mm	125 mm	HIAB-330-1303		72.55
MODEL 140								
BOOM EXT			I-U-15	50 mm	80 mm	HIAB-330-1044		30.24
	AW		P-U-13	40, 90 mm	70, 105 mm	HIAB-330-0668		104.73
	AWV		I-U-13	33 mm	60 mm	HIAB-330-1001		19.55
INNER BOOM			I-U-13	80 mm	140 mm	HIAB-330-1036		82.75
OUTER BOOM			I-U-13	80 mm	140 mm	HIAB-330-1036		82.75

Replacement Kits For

HIAB

Cranes								
APPLICATION	CYL #	SERIAL #	CODE	ROD	BORE	KIT #	MISC	List \$
MODEL 175								
BOOM EXT EXTENSION INNER BOOM OUTER BOOM OUTRIGGER	3608603		P-U-15	40 mm	63 mm	HIAB-330-1613		33.92
	3616819		P-U-15	45 mm	70 mm	HIAB-330-1583		38.92
	3622100		P-U-15	45 mm	70 mm	HIAB-330-1583		38.92
	3625681		P-U-15	40 mm	63 mm	HIAB-330-1613		33.92
	3583872		P-U-15	25 mm	40 mm	HIAB-330-1052		49.62
	3625745		P-U-15	100 mm	160 mm	HIAB-330-1443		92.75
	3561330		P-U-15	100 mm	140 mm	HIAB-330-1290		59.59
	3531031		P-U-15	70 mm	90 mm	HIAB-330-1028		33.78
	3592774		P-U-15	70 mm	90 mm	HIAB-330-1028		33.78
3594769		P-U-15	70 mm	90 mm	HIAB-330-1028		33.78	
MODEL 1770								
BOOM EXT	A		I-U-15	50 mm	80 mm	HIAB-330-1044		30.24
	AW		P-U-13	40, 90 mm	70, 105 mm	HIAB-330-0668	2-Stage Telescopic	104.73
INNER BOOM			P-U-13	80 mm	125 mm	HIAB-872-8330		52.34
OUTER BOOM			P-U-13	100 mm	180 mm	HIAB-872-8348		80.79
OUTRIGGER			P-U-15	90 mm	110 mm	HIAB-330-0773	13 Ton Leg	54.46
MODEL 2640								
BOOM EXT			I-U-13	63 mm	100 mm	HIAB-330-0641		42.77
INNER BOOM			P-U-13	100 mm	140 mm	HIAB-872-8038		58.61
OUTER BOOM			P-U-13	100 mm	140 mm	HIAB-872-8038		58.61
MODEL 650								
BOOM EXT	3088031		I-U-13	33 mm	60 mm	HIAB-330-1001		19.55
	AW		P-U-13	35, 82 mm	60, 92 mm	HIAB-330-0731	Model 650/1, 2-stage Telescopic	103.41
D. BOOM EXT	AW		P-U-13	32, 85 mm	65, 100 mm	HIAB-330-0633	2-stage Telescopic	76.88
	3080005		P-U-13	35, 82 mm	60, 92 mm	HIAB-330-0731		103.41
	3199622		P-U-13	32, 85 mm	65, 100 mm	HIAB-330-0633		76.88
	3402746		P-U-13	32, 85 mm	65, 100 mm	HIAB-330-0633		76.88
	3411176		P-U-13	32, 85 mm	65, 100 mm	HIAB-330-0633		76.88
	3419258		P-U-13	35, 82 mm	60, 92 mm	HIAB-330-0731		103.41
	6216765		P-U-13	32, 85 mm	65, 100 mm	HIAB-330-0633		76.88
D.A. INNER BOOM	3051919		I-U-15	100 mm	140 mm	HIAB-330-0501		56.16
	3091919		I-U-15	100 mm	140 mm	HIAB-330-0501		56.16
	3099199	90001-->	I-U-13	100 mm	140 mm	HIAB-330-0749		57.43
INNER BOOM		90001-->	I-U-13	100 mm	140 mm	HIAB-330-0749		57.43
	3155528	-->65450	I-U-1	140 mm	160 mm	HIAB-330-0218		52.48
MODEL 985								
1ST EXTENSION			P-SP-15	45 mm	70 mm	HIAB-330-0714		32.51
2ND EXTENSION			P-U-13	35, 82 mm	60, 92 mm	HIAB-330-0731		103.41
3RD EXTENSION			I-U-15	33 mm	60 mm	HIAB-330-0595		26.90
AH EXTENSION			P-SP-15	45 mm	70 mm	HIAB-330-0714		32.51
INNER BOOM			I-SP-15	80 mm	125 mm	HIAB-330-0692		55.12
OUTER BOOM			I-SP-15	80 mm	125 mm	HIAB-330-0692		55.12

REPLACEMENT KITS FOR HIAB

HIAB

Kit Number	Code (Pg. x)	Rod X Bore Size	List Price
HIAB-121039	P-U-15	63 x 110 mm	\$ 45.22
HIAB-330-0218	I-U-1	140 X 160 mm	52.48
HIAB-330-0315	N-N-5	100 mm Piston Kit	60.70
HIAB-330-0498	N-N-5	105 MM Piston Kit	67.16
HIAB-330-0501	I-U-15	100 X 140 mm	56.16
HIAB-330-0528	N-N-5	105 mm Piston Kit	68.65
HIAB-330-0595	I-U-15	33 X 60 mm	26.90
HIAB-330-0625	P-O-1	78 mm Rod Kit	23.09
HIAB-330-0633	P-U-15	32, 85 X 65, 100 mm	76.88
HIAB-330-0641	I-U-15	63 X 100 mm	42.77
HIAB-330-0668	P-U-15	40 , 90 mm Stage OD's	104.73
HIAB-330-0692	I-U-15	80 X 125 mm	55.12
HIAB-330-0714	P-SP-15	45 X 70 mm	32.51
HIAB-330-0731	P-U-15	35, 80 mm Stage OD's	103.41
HIAB-330-0749	I-U-15	100 X 140 mm	57.43
HIAB-330-0773	P-U-15	90 X 110 mm	54.46
HIAB-330-0871	P-U-15	90 X 125 mm	100.95
HIAB-330-0889	P-U-15	70 X 100 mm	57.66
HIAB-330-0897	P-U-15	33 X 60 mm	21.30
HIAB-330-0951	P-U-15	100 X 180 mm	74.24
HIAB-330-1001	I-U-15	33 X 60 mm	19.55
HIAB-330-1028	P-U-15	70 X 90 mm	33.78
HIAB-330-1036	I-U-15	80 X 140 mm	82.75
HIAB-330-1044	I-U-15	50 X 80 mm	30.24
HIAB-330-1052	P-U-15	25 X 40 mm	49.62
HIAB-330-1061	P-U-15	70 X 125 mm	49.29
HIAB-330-1231	P-U-15	90 X 160 mm	73.86
HIAB-330-1249	P-U-15	40 x 70 mm	33.39
HIAB-330-1290	P-U-15	100 X 140 mm	59.59
HIAB-330-1303	P-U-15	90 X 125 mm	72.55
HIAB-330-1311	P-U-15	45 X 63 mm	26.62

Kit Number	Code (Pg. x)	Rod X Bore Size	List Price
HIAB-330-1320	P-U-15	40 X 63 mm	\$ 29.82
HIAB-330-1443	P-U-15	100 X 160 mm	103.09
HIAB-330-1583	P-U-15	45 X 70 mm	38.92
HIAB-330-1613	P-U-15	40 X 63 mm	33.92
HIAB-542105	P-U-15	50 X 90 mm	38.58
HIAB-542113	P-U-15	50 X 90 mm	38.58
HIAB-542121	P-U-15	40 X 55 mm	34.62
HIAB-542130	P-U-15	30 X 50 mm	31.33
HIAB-542148	I-N-15	100 mm Piston Kit	63.07
HIAB-542156	P-U-15	50 X 70 mm	45.13
HIAB-607-2267	I-O-15	74 X 85 mm	27.75
HIAB-622-1599	I-U-15	63 X 125 mm	43.25
HIAB-622-1661	I-SP-15	63 X 140 mm	57.88
HIAB-622-1670	I-SP-15	70 X 140 mm	61.33
HIAB-622-1688	I-SP-15	80 X 140 mm	63.37
HIAB-622-2170	TELE.	32, 90 mm Stage OD's	119.57
HIAB-711-4659	P-U-15	50 x 110 mm	58.51
HIAB-711-4660	I-U-15	30 x 50 mm	22.20
HIAB-711-5366	I,P-U-15	80 X 140 mm	68.56
HIAB-711-5834	I-U-15	30 X 70 mm	29.83
HIAB-712-4173	P,I-U-15	100 x 180 mm	170.19
HIAB-712-4174	I-U-15	50 x 90 mm	69.77
HIAB-825-2050	P-U-15	45 X 80 mm	34.34
HIAB-872-8038	P-U-15	100 X 140 mm	58.61
HIAB-872-8046	P-U-15	100 X 140 mm	76.21
HIAB-872-8330	P-U-15	80 X 125 mm	52.34
HIAB-872-8348	P-U-15	100 X 180 mm	80.79
HIAB-872-8356	I-SP-15	50 X 80 mm	32.93
HIAB-995-0621	N-N-4	100 mm Piston Kit	30.21
HIAB-995-9122	N-N-5	105 mm Piston Kit	32.86



Replacement Kits For

HITACHI

Excavators								
APPLICATION	CYL #	SERIAL #	CODE	ROD	BORE	KIT #	MISC	List \$
MODEL EX100								
ARM			P-UB-10	75 mm	105 mm	HIT-4206343		81.65
BOOM			P-UB-10	70 mm	95 mm	HIT-4206340		88.41
BUCKET			P-UB-10	65 mm	95 mm	HIT-4206345		86.07
MODEL EX120								
ARM			P-UB-10	80 mm	115 mm	HIT-4206344		92.78
BOOM			P-UB-10	75 mm	105 mm	HIT-4206343		81.65
BUCKET			P-UB-10	65 mm	95 mm	HIT-4206345		86.07
MODEL EX120-2								
ARM			P-UB-10	80 mm	110 mm	HIT-4286463		93.91
BOOM			P-UB-10	70 mm	105 mm	HIT-4286459		77.88
BUCKET			P-UB-10	65 mm	95 mm	HIT-4286739		86.10
MODEL EX150								
ARM	4193532	01001-UP	P-UB-10	85 mm	120 mm	HIT-4216264P		143.98
BOOM LH	4193533	01001-UP	P-UB-10	80 mm	115 mm	HIT-4369893P		116.37
BOOM RH	4193531	01001-UP	P-UB-10	80 mm	115 mm	HIT-4369893P		116.37
BUCKET	4193534	01001-UP	P-UB-10	80 mm	115 mm	HIT-4369893P		116.37
MODEL EX150LC-5, EX160LC-5								
ARM	4370784	1002-UP	P-UB-10	85 mm	115 mm	HIT-4389720		147.65
	4370784	1002-UP		85 mm		HIT-4272960	Bushing	21.62
	4370784	1002-UP			115 mm	HIT-0686405	Wear Ring	7.53
	4370784	1002-UP			115 mm	HIT-0310908	Wear Ring	15.65
BOOM LH	4370783	1002-UP	P-UB-10	80 mm	110 mm	HIT-4389719		130.19
	4370783	1002-UP		80 mm		HIT-0309304	Bushing	19.46
	4370783	1002-UP			110 mm	HIT-0667008	Wear Ring	7.53
BOOM RH	4370783	1002-UP			110 mm	HIT-0298907	Wear Ring	30.61
	4370782	1002-UP	P-UB-10	80 mm	110 mm	HIT-4389719		130.19
	4370782	1002-UP		80 mm		HIT-0309304	Bushing	19.46
BUCKET	4370782	1002-UP			110 mm	HIT-0298907	Wear Ring	30.61
	4370782	1002-UP			110 mm	HIT-0667008	Wear Ring	7.53
	4370785	1002-UP	P-UB-10	75 mm	105 mm	HIT-4389721		95.96
BUCKET	4370785	1002-UP		75 mm		HIT-0310504	Bushing	16.89
	4370785	1002-UP			105 mm	HIT-0310510	Wear Ring	65.29
	4370785	1002-UP			105 mm	HIT-0666808	Wear Ring	23.84
MODEL EX200, EX200LC								
ARM	4180278	30001-UP	P-UB-10	95 mm	135 mm	HIT-4206019		167.20
BOOM LH	4180277	30001-UP	P-UB-10	85 mm	125 mm	HIT-4206018		113.21
	4223826	30001-UP	P-UB-10	85 mm	125 mm	HIT-4206018		113.21
BOOM RH	4180276	30001-UP	P-UB-10	85 mm	125 mm	HIT-4206018		113.21
	4223825	30001-UP	P-UB-10	85 mm	125 mm	HIT-4206018		113.21
BUCKET	4180279	30001-UP	P-UB-10	80 mm	120 mm	HIT-4206020		125.91
CLAMSHELL	2024987	30001-UP	P-UB-10	85 mm	135 mm	HIT-4214722		117.57
MODEL EX200-2, EX200LC-2								
ARM	4250226	60001-D91/12	P-UB-10	95 mm	130 mm	HIT-4286780		128.66

Hercules Bulldog and original equipment Hitachi kits may not include the necessary wear rings for your cylinder rebuild. Please ask your sales representative for a cross-reference if no complementary parts are listed.

Replacement Kits For

HITACHI

HITACHI

Excavators								
APPLICATION	CYL #	SERIAL #	CODE	ROD	BORE	KIT #	MISC	List \$
MODEL EX200-2, EX200LC-2								
ARM	4250226	60001-UP		95 mm		HIT-0309204	Bushing	23.48
	4250226	60001-UP			130 mm	HIT-0254309	Wear Ring	19.29
	4250226	60001-UP			130 mm	HIT-0409912	Wear Ring	9.55
BOOM LH	4250224	60001-D91/12	P-UB-10	85 mm	120 mm	HIT-4286774		124.34
	4250224	60001-UP		85 mm		HIT-4272960	Bushing	21.62
	4250224	60001-UP			120 mm	HIT-0261308	Wear Ring	18.19
BOOM RH	4250224	60001-UP			120 mm	HIT-0309309	Wear Ring	7.75
	4250223	60001-D91/12	P-UB-10	85 mm	120 mm	HIT-4286774		124.34
	4250223	60001-UP		85 mm		HIT-4272960	Bushing	21.62
BUCKET	4250223	60001-UP			120 mm	HIT-0309309	Wear Ring	7.75
	4250223	60001-UP			120 mm	HIT-0261308	Wear Ring	18.19
	4250225	60001-D91/12	P-UB-10	75 mm	110 mm	HIT-4286784		89.19
BUCKET (River)	4250225	60001-UP		75 mm		HIT-0310504	Bushing	16.89
	4250225	60001-UP			110 mm	HIT-0410005	Wear Ring	7.38
	4250225	60001-UP			110 mm	HIT-0298907	Wear Ring	30.61
CLAMSHELL	4287889	60001-D91/12	P-UB-10	65 mm	95 mm	HIT-4286739		86.10
	4287889	60001-UP		65 mm		HIT-0310604	Bushing	13.52
	4287889	60001-UP			95 mm	HIT-0310609	Wear Ring	6.22
ROLLING	4287889	60001-UP			95 mm	HIT-0310610	Wear Ring	14.60
	4288743	60001-UP	P-UB-10	85 mm	125 mm	HIT-4369902		192.73
	4288743	60001-UP		85 mm		HIT-4272960	Bushing	21.62
BUCKET	4288743	60001-UP			125 mm	HIT-0309009	Wear Ring	8.11
	4288743	60001-UP			125 mm	HIT-0223713	Wear Ring	18.94
	4305528	65612-UP	P-UB-10	95 mm	150 mm	HIT-4320954		121.81
BUCKET (River)	4305528	65612-UP		95 mm		HIT-0309204	Bushing	23.48
	4305528	65612-UP			150 mm	HIT-0387305	Wear Ring	10.54
	4305528	65612-UP			150 mm	HIT-0237220	Wear Ring	21.98
MODEL EX200-3, EX200LC-3, EX200H-3, EX200LCH-3								
ARM	4314778	D95/06-UP	P-UB-10	95 mm	130 mm	HIT-4369914		154.33
	4314778	78001-UP		95 mm		HIT-0309204	Bushing	23.48
	4314778	78001-UP			130 mm	HIT-0409912	Wear Ring	9.55
BOOM LH	4314778	78001-UP			130 mm	HIT-0254309	Wear Ring	19.29
	4250224	D95/06-UP	P-UB-10	85 mm	120 mm	HIT-4369901		120.63
	4250224	78001-UP		85 mm		HIT-4272960	Bushing	21.62
BOOM RH	4250224	78001-UP			120 mm	HIT-0261308	Wear Ring	18.19
	4250224	78001-UP			120 mm	HIT-0309309	Wear Ring	7.75
	4250223	D95/06-UP	P-UB-10	85 mm	120 mm	HIT-4369901		120.63
BUCKET	4250223	78001-UP		85 mm		HIT-4272960	Bushing	21.62
	4250223	78001-UP			120 mm	HIT-0309309	Wear Ring	7.75
	4250223	78001-UP			120 mm	HIT-0261308	Wear Ring	18.19
BUCKET (River)	4250225	D95/06-UP	P-UB-10	75 mm	110 mm	HIT-4369890		108.53
	4250225	78001-UP		75 mm		HIT-0310504	Bushing	16.89
	4250225	78001-UP			110 mm	HIT-0410005	Wear Ring	7.38
BUCKET (River)	4250225	78001-UP			110 mm	HIT-0298907	Wear Ring	30.61
	4287889	D95/06-UP	P-UB-10	65 mm	95 mm	HIT-4369766		70.31
	4287889	78001-UP		65 mm		HIT-0310604	Bushing	13.52

Hercules Bulldog and original equipment Hitachi kits may not include the necessary wear rings for your cylinder rebuild. Please ask your sales representative for a cross-reference if no complementary parts are listed.

Replacement Kits For

HITACHI

Excavators								
APPLICATION	CYL #	SERIAL #	CODE	ROD	BORE	KIT #	MISC	List \$
MODEL EX200-3, EX200LC-3, EX200H-3, EX200LCH-3								
BUCKET (River)	4287889	78001-UP			95 mm	HIT-0310610	Wear Ring	14.60
	4287889	78001-UP			95 mm	HIT-0310609	Wear Ring	6.22
CLAMSHELL	4288743	78001-D95/05	P-UB-10	85 mm	125 mm	HIT-4369902		192.73
	4288743	D95/06-UP	P-UB-10	85 mm	125 mm	HIT-4369902		192.73
	4288743	78001-UP		85 mm		HIT-4272960	Bushing	21.62
	4288743	78001-UP			125 mm	HIT-0309009	Wear Ring	8.11
	4288743	78001-UP			125 mm	HIT-0223713	Wear Ring	18.94
MODEL EX200-5, EX200LC-5, EX210H-5, EX210LCH-5								
ARM	4316930	050001-UP	P-UB-10	95 mm	130 mm	HIT-4364916		158.95
	4316930	050001-UP		95 mm		HIT-0309204	Bushing	23.48
	4316930	050001-UP			130 mm	HIT-0667409	Wear Ring	9.03
	4316930	050001-UP			130 mm	HIT-0254309	Wear Ring	19.29
	4372914	050001-UP	P-UB-10	95 mm	130 mm	HIT-4364916		158.95
	4372914	050001-UP		95 mm		HIT-0309204	Bushing	23.48
	4372914	050001-UP			130 mm	HIT-0667409	Wear Ring	9.03
BOOM LH	4372914	050001-UP			130 mm	HIT-0254309	Wear Ring	19.29
	4317394	050001-UP	P-UB-10	85 mm	120 mm	HIT-4364915		125.96
	4317394	050001-UP		85 mm		HIT-4272960	Bushing	21.62
	4317394	050001-UP			120 mm	HIT-0667206	Wear Ring	8.10
	4317394	050001-UP			120 mm	HIT-0261308	Wear Ring	18.19
	4372913	050001-UP	P-UB-10	85 mm	120 mm	HIT-4364915		125.96
	4372913	050001-UP		85 mm		HIT-4272960	Bushing	21.62
	4372913	050001-UP			120 mm	HIT-0667206	Wear Ring	8.10
	4372913	050001-UP			120 mm	HIT-0261308	Wear Ring	18.19
	BOOM RH	4317393	050001-UP	P-UB-10	85 mm	120 mm	HIT-4364915	
4317393		050001-UP		85 mm		HIT-4272960	Bushing	21.62
4317393		050001-UP			120 mm	HIT-0667206	Wear Ring	8.10
4317393		050001-UP			120 mm	HIT-0261308	Wear Ring	18.19
4372912		050001-UP	P-UB-10	85 mm	120 mm	HIT-4364915		125.96
4372912		050001-UP		85 mm		HIT-4272960	Bushing	21.62
4372912		050001-UP			120 mm	HIT-0667206	Wear Ring	8.10
BUCKET	4372912	050001-UP			120 mm	HIT-0261308	Wear Ring	18.19
	4318327	050001-UP	P-UB-10	75 mm	110 mm	HIT-4369890		108.53
	4318327	050001-UP		75 mm		HIT-0310504	Bushing	16.89
	4318327	050001-UP			110 mm	HIT-0298907	Wear Ring	30.61
	4318327	050001-UP			110 mm	HIT-0410005	Wear Ring	7.38
	4372915	050001-UP	P-UB-10	75 mm	110 mm	HIT-4369890		108.53
	4372915	050001-UP		75 mm		HIT-0310504	Bushing	16.89
	4372915	050001-UP			110 mm	HIT-0298907	Wear Ring	30.61
	4372915	050001-UP			110 mm	HIT-0410005	Wear Ring	7.38
	BUCKET (River)	4371061	050001-UP	P-UB-10	65 mm	95 mm	HIT-4369766	
4371061		050001-UP		65 mm		HIT-0310604	Bushing	13.52
4371061		050001-UP			95 mm	HIT-0310610	Wear Ring	14.60
4371061		050001-UP			95 mm	HIT-0310609	Wear Ring	6.22
CLAMSHELL	4288743	050001-UP	P-UB-10	85 mm	125 mm	HIT-4369902		192.73
	4288743	050001-UP		85 mm		HIT-4272960	Bushing	21.62

Hercules Bulldog and original equipment Hitachi kits may not include the necessary wear rings for your cylinder rebuild. Please ask your sales representative for a cross-reference if no complementary parts are listed.

Replacement Kits For

HITACHI

HITACHI

Excavators								
APPLICATION	CYL #	SERIAL #	CODE	ROD	BORE	KIT #	MISC	List \$
MODEL EX200-5, EX200LC-5, EX210H-5, EX210LCH-5								
CLAMSHELL	4288743	050001-UP			125 mm	HIT-0309009	Wear Ring	8.11
	4288743	050001-UP			125 mm	HIT-0223713	Wear Ring	18.94
MODEL EX220								
ARM			P-UB-10	100 mm	145 mm	HIT-4203831		141.23
BOOM			P-UB-10	90 mm	135 mm	HIT-4203830		130.19
BUCKET			P-UB-10	90 mm	135 mm	HIT-4203830		130.19
MODEL EX220-2								
ARM			P-UB-10	100 mm	135 mm	HIT-9103843		151.37
BOOM			P-UB-10	90 mm	125 mm	HIT-9103842		115.55
BUCKET			P-UB-10	85 mm	125 mm	HIT-9103844		116.54
MODEL EX220-3, EX220LC-3								
ARM	9101317	10001-UP	P-UB-10	100 mm	135 mm	HIT-9103843		151.37
	9101317	10001-UP		100 mm		HIT-4272963	Bushing	32.44
	9101317	10001-UP			135 mm	HIT-4252191	Wear Ring	11.89
	9101317	10001-UP			135 mm	HIT-4185246	Wear Ring	23.02
BOOM LH	9101316	10001-UP	P-UB-10	90 mm	125 mm	HIT-9103842		115.55
	9101316	10001-UP		90 mm		HIT-4272961	Bushing	20.85
	9101316	10001-UP			125 mm	HIT-4253562	Wear Ring	8.65
BOOM RH	9101316	10001-UP			125 mm	HIT-4168234	Wear Ring	41.21
	9101315	10001-UP	P-UB-10	90 mm	125 mm	HIT-9103842		115.55
	9101315	10001-UP		90 mm		HIT-4272961	Bushing	20.85
BUCKET	9101315	10001-UP			125 mm	HIT-4168234	Wear Ring	41.21
	9101315	10001-UP			125 mm	HIT-4253562	Wear Ring	8.65
	9101318	10001-UP	P-UB-10	85 mm	125 mm	HIT-9103844		116.54
	9101318	10001-UP		85 mm		HIT-4272960	Bushing	21.62
	9101318	10001-UP			125 mm	HIT-4168234	Wear Ring	41.21
	9101318	10001-UP			125 mm	HIT-4253562	Wear Ring	8.65
MODEL EX220-5, EX220LC-5, EX230-5, EX230LC-5, EX230H-5, EX230LCH-5								
ARM	9101317	1001-UP	P-UB-14	100 mm	135 mm	HIT-9178284		117.85
	9101317	1001-UP		100 mm		HIT-4272963	Bushing	32.44
	9101317	1001-UP			135 mm	HIT-4185246	Wear Ring	23.02
	9101317	1001-UP			135 mm	HIT-4252191	Wear Ring	11.89
	9147233	D96/12-UP	P-UB-14	100 mm	135 mm	HIT-9178284		117.85
	9147233	1001-UP		100 mm		HIT-4272963	Bushing	32.44
	9147233	1001-UP			135 mm	HIT-4185246	Wear Ring	23.02
	9147233	1001-UP			135 mm	HIT-4252191	Wear Ring	11.89
ARM (River)	4380500	1001-UP	P-UB-10	105 mm	145 mm	HIT-4369943		167.87
	4380500	1001-UP		105 mm		HIT-0373405	Bushing	27.68
	4380500	1001-UP			145 mm	HIT-0373413	Wear Ring	31.30
	4380500	1001-UP			145 mm	HIT-0492209	Wear Ring	10.46
BOOM LH	9101316	1001-UP	P-UB-14	90 mm	125 mm	HIT-9178283		86.29
	9101316	1001-UP		90 mm		HIT-4272961	Bushing	20.85
	9101316	1001-UP			125 mm	HIT-4253562	Wear Ring	8.65
	9101316	1001-UP			125 mm	HIT-4168234	Wear Ring	41.21
	9147232	D96/12-UP	P-UB-14	90 mm	125 mm	HIT-9178283		86.29
	9147232	1001-UP		90 mm		HIT-4272961	Bushing	20.85

Hercules Bulldog and original equipment Hitachi kits may not include the necessary wear rings for your cylinder rebuild. Please ask your sales representative for a cross-reference if no complementary parts are listed.

Replacement Kits For

HITACHI

Excavators								
APPLICATION	CYL #	SERIAL #	CODE	ROD	BORE	KIT #	MISC	List \$
MODEL EX220-5, EX220LC-5, EX230-5, EX230LC-5, EX230H-5, EX230LCH-5								
BOOM LH	9147232	1001-UP			125 mm	HIT-4168234	Wear Ring	41.21
	9147232	1001-UP			125 mm	HIT-4253562	Wear Ring	8.65
BOOM RH	9101315	1001-UP	P-UB-14	90 mm	125 mm	HIT-9178283		86.29
	9101315	1001-UP		90 mm		HIT-4272961	Bushing	20.85
BUCKET	9101315	1001-UP			125 mm	HIT-4253562	Wear Ring	8.65
	9101315	1001-UP			125 mm	HIT-4168234	Wear Ring	41.21
	9147231	1001-D96/11	P-UB-14	90 mm	125 mm	HIT-9178283		86.29
	9147231	1001-UP		90 mm		HIT-4272961	Bushing	20.85
	9147231	1001-UP			125 mm	HIT-4168234	Wear Ring	41.21
	9147231	1001-UP			125 mm	HIT-4253562	Wear Ring	8.65
	9101318	1001-UP	P-UB-14	85 mm	125 mm	HIT-9178294		90.35
	9101318	1001-UP		85 mm		HIT-4272960	Bushing	21.62
	9101318	1001-UP			125 mm	HIT-4168234	Wear Ring	41.21
	9101318	1001-UP			125 mm	HIT-4253562	Wear Ring	8.65
BUCKET (River)	9147234	D96/12-UP	P-UB-14	85 mm	125 mm	HIT-9178294		90.35
	9147234	1001-UP		85 mm		HIT-4272960	Bushing	21.62
	9147234	1001-UP			125 mm	HIT-4253562	Wear Ring	8.65
	9147234	1001-UP			125 mm	HIT-4168234	Wear Ring	41.21
	4371061	1001-UP	P-UB-10	65 mm	95 mm	HIT-4369766		70.31
	4371061	1001-UP		65 mm		HIT-0310604	Bushing	13.52
	4371061	1001-UP			95 mm	HIT-0310610	Wear Ring	14.60
	4371061	1001-UP			95 mm	HIT-0310609	Wear Ring	6.22
MODEL EX270, EX270LC								
ARM	9076106	50001-UP	P-UB-14	105 mm	150 mm	HIT-9078844		207.88
BOOM	ALL	50001-UP	P-UB-10	95 mm	145 mm	HIT-9078843		138.91
BUCKET	ALL	50001-UP	P-UB-10	95 mm	145 mm	HIT-9078843		138.91
MODEL EX270-5, EX270LC-5, EX280H-5, EX280LCH-5								
ARM	9147237	10001-UP	P-UB-14	100 mm	145 mm	HIT-9180579		125.69
	9147237	10001-UP		100 mm		HIT-4272963	Bushing	32.44
BOOM LH	9147237	10001-UP			145 mm	HIT-4194621	Wear Ring	11.35
	9147237	10001-UP			145 mm	HIT-4185247	Wear Ring	25.18
	9147236	10001-UP	P-UB-14	95 mm	135 mm	HIT-9180587		110.75
	9147236	10001-UP		95 mm		HIT-4272962	Bushing	23.48
BOOM RH	9147236	10001-UP			135 mm	HIT-4185246	Wear Ring	23.02
	9147236	10001-UP			135 mm	HIT-4252191	Wear Ring	11.89
	9147235	10001-UP	P-UB-14	95 mm	135 mm	HIT-9180587		110.75
	9147235	10001-UP		95 mm		HIT-4272962	Bushing	23.48
BUCKET	9147235	10001-UP			135 mm	HIT-4185246	Wear Ring	23.02
	9147235	10001-UP			135 mm	HIT-4252191	Wear Ring	11.89
	9147238	10001-UP	P-UB-14	90 mm	135 mm	HIT-9180580		101.09
	9147238	10001-UP		90 mm		HIT-4272961	Bushing	20.85
BUCKET	9147238	10001-UP			135 mm	HIT-4252191	Wear Ring	11.89
	9147238	10001-UP			135 mm	HIT-4185246	Wear Ring	23.02
MODEL EX300, EX300LC								
ARM			P-UB-10	110 mm	165 mm	HIT-9078846		204.03
BOOM			P-UB-10	100 mm	145 mm	HIT-9078845		141.23

Hercules Bulldog and original equipment Hitachi kits may not include the necessary wear rings for your cylinder rebuild. Please ask your sales representative for a cross-reference if no complementary parts are listed.

Replacement Kits For

HITACHI

HITACHI

Excavators								
APPLICATION	CYL #	SERIAL #	CODE	ROD	BORE	KIT #	MISC	List \$
MODEL EX300, EX300LC								
BUCKET			P-UB-10	95 mm	145 mm	HIT-9078843		138.91
MODEL EX300-3, EX300LC-3, EX300H-3, EX300LCH-3								
ARM	9122617		P-UB-14	110 mm	165 mm	HIT-9123264		113.67
	9122617	7001-UP		110 mm		HIT-4284534	Bushing	52.61
	9122617	7001-UP			165 mm	HIT-4194624	Wear Ring	53.34
	9122617	7001-UP			165 mm	HIT-4194623	Wear Ring	16.22
BOOM LH	9122616	7001-UP	P-UB-10	100 mm	145 mm	HIT-9078845		141.23
	9122616	7001-UP		100 mm		HIT-4272963	Bushing	32.44
	9122616	7001-UP			145 mm	HIT-4185247	Wear Ring	25.18
BOOM RH	9122616	7001-UP			145 mm	HIT-4185249	Wear Ring	11.58
	9122615	7001-UP	P-UB-10	100 mm	145 mm	HIT-9078845		141.23
	9122615	7001-UP		100 mm		HIT-4272963	Bushing	32.44
BUCKET	9122615	7001-UP			145 mm	HIT-4185247	Wear Ring	25.18
	9122615	7001-UP			145 mm	HIT-4185249	Wear Ring	11.58
	9122618	7001-HL803556	P-UB-14	95 mm	145 mm	HIT-9123265		90.26
	9122618	HL803557-UP	P-UB-14	95 mm	145 mm	HIT-9175564		102.04
BUCKET (River)	9122618	7001-UP		95 mm		HIT-4284535	Bushing	27.64
	9122618	7001-UP			145 mm	HIT-4185247	Wear Ring	25.18
	9122618	7001-UP			145 mm	HIT-4185249	Wear Ring	11.58
	4326775	7001-UP	P-UB-10	65 mm	100 mm	HIT-4369767		73.86
	4326775	7001-UP		65 mm		HIT-0310604	Bushing	13.52
	4326775	7001-UP			100 mm	HIT-0254908	Wear Ring	28.05
	4326775	7001-UP			100 mm	HIT-0326005	Wear Ring	6.92
MODEL EX300-5, EX330-5, EX350-5, EX370-5 (H,HD,K,&LC)								
ARM	9164990	20001-UP	P-UB-14	115 mm	170 mm	HIT-9180582		150.25
	9164990	20001-UP		115 mm		HIT-4370337	Bushing	41.35
	9164990	20001-UP			170 mm	HIT-4370064	Wear Ring	21.08
	9164990	20001-UP			170 mm	HIT-4370063	Wear Ring	33.07
BOOM LH	9164872	20001-UP	P-UB-14	105 mm	150 mm	HIT-9180581		172.16
	9164872	20001-UP		105 mm		HIT-4383093	Bushing	29.19
	9164872	20001-UP			150 mm	HIT-4194622	Wear Ring	12.45
BOOM RH	9164872	20001-UP			150 mm	HIT-4171490	Wear Ring	26.39
	9164874	20001-UP	P-UB-14	105 mm	150 mm	HIT-9180581		172.16
	9164874	20001-UP		105 mm		HIT-4383093	Bushing	29.19
BUCKET	9164874	20001-UP			150 mm	HIT-4194622	Wear Ring	12.45
	9164874	20001-UP			150 mm	HIT-4171490	Wear Ring	26.39
	9164997	20001-UP	P-UB-14	95 mm	145 mm	HIT-9175564		102.04
	9164997	20001-UP		95 mm		HIT-4284535	Bushing	27.64
BUCKET	9164997	20001-UP			145 mm	HIT-4185247	Wear Ring	25.18
	9164997	20001-UP			145 mm	HIT-4185249	Wear Ring	11.58
	MODEL EX400, EX400LC, EX400H, EX400LCH							
ARM	4206480	02001-UP	P-UB-10	130 mm	190 mm	HIT-4236058		215.14
BOOM LH	4206479	02001-UP	P-UB-10	115 mm	170 mm	HIT-4236057		198.75
BOOM RH	4206478	02001-UP	P-UB-10	115 mm	170 mm	HIT-4236057		198.75
BUCKET	4206481	02001-UP	P-UB-10	115 mm	170 mm	HIT-4236057		198.75

Hercules Bulldog and original equipment Hitachi kits may not include the necessary wear rings for your cylinder rebuild. Please ask your sales representative for a cross-reference if no complementary parts are listed.

Replacement Kits For

HITACHI

Excavators								
APPLICATION	CYL #	SERIAL #	CODE	ROD	BORE	KIT #	MISC	List \$
MODEL EX400-3, EX400LC-3, EX400H-3, EX400LCH-3								
ARM	4310243	5001-UP	P-UB-10	130 mm	190 mm	HIT-4438679		192.66
	4310243	5001-UP		130 mm		HIT-0353004	Bushing	44.33
	4310243	5001-UP			190 mm	HIT-0242512	Wear Ring	34.39
	4310243	5001-UP			190 mm	HIT-0420307	Wear Ring	22.71
	4310243	5001-UP		130 mm		HIT-0417605	Wear Ring	23.59
ARM (Load Shvl)	4219778	5001-UP	P-UB-10	115 mm	170 mm	HIT-4236057		198.75
	4219778	5001-UP		115 mm		HIT-0352704	Bushing	31.27
	4219778	5001-UP			170 mm	HIT-0352712	Wear Ring	22.01
	4219778	5001-UP			170 mm	HIT-0259307	Wear Ring	33.07
	4219778	5001-UP		115 mm		HIT-0352708	Wear Ring	15.55
BOOM LH	4310242	5001-UP	P-UB-10	115 mm	170 mm	HIT-4438672		228.88
	4310242	5001-UP		115 mm		HIT-0352704	Bushing	31.27
	4310242	5001-UP			170 mm	HIT-0420109	Wear Ring	12.62
	4310242	5001-UP			170 mm	HIT-0259307	Wear Ring	33.07
	4310242	5001-UP		115 mm		HIT-0460004	Wear Ring	15.33
BOOM LH (Load Shvl)	4249749	5162, 5164	P-UB-10	115 mm	170 mm	HIT-4236057		198.75
	4249749	5162, 5164		115 mm		HIT-0352704	Bushing	31.27
	4249749	5162, 5164			170 mm	HIT-0259307	Wear Ring	33.07
	4249749	5162, 5164			170 mm	HIT-0352712	Wear Ring	22.01
	4249749	5162, 5164		115 mm		HIT-0352708	Wear Ring	15.55
BOOM RH	4350424	5001-UP	P-UB-10	115 mm	170 mm	HIT-4438672		228.88
	4350424	5001-UP		115 mm		HIT-0352704	Bushing	31.27
	4350424	5001-UP			170 mm	HIT-0259307	Wear Ring	33.07
	4350424	5001-UP			170 mm	HIT-0420109	Wear Ring	12.62
	4350424	5001-UP		115 mm		HIT-0460004	Wear Ring	15.33
	4310241	5001-UP	P-UB-10	115 mm	170 mm	HIT-4438672		228.88
	4310241	5001-UP		115 mm		HIT-0352704	Bushing	31.27
	4310241	5001-UP			170 mm	HIT-0420109	Wear Ring	12.62
	4310241	5001-UP		115 mm		HIT-0460004	Wear Ring	15.33
	4310241	5001-UP			170 mm	HIT-0259307	Wear Ring	33.07
BOOM RH (Load Shvl)	4249748	5162, 5164	P-UB-10	115 mm	170 mm	HIT-4236057		198.75
	4249748	5162, 5164		115 mm		HIT-0352704	Bushing	31.27
	4249748	5162, 5164			170 mm	HIT-0259307	Wear Ring	33.07
	4249748	5162, 5164		115 mm		HIT-0352708	Wear Ring	15.55
	4249748	5162, 5164			170 mm	HIT-0352712	Wear Ring	22.01
BUCKET	4350423	5001-UP	P-UB-10	115 mm	170 mm	HIT-4438672		228.88
	4350423	5001-UP		115 mm		HIT-0352704	Bushing	31.27
	4350423	5001-UP		115 mm		HIT-0460004	Wear Ring	15.33
	4350423	5001-UP			170 mm	HIT-0420109	Wear Ring	12.62
	4350423	5001-UP			170 mm	HIT-0259307	Wear Ring	33.07
	4310244	5001-UP	P-UB-10	115 mm	170 mm	HIT-4438672		228.88
	4310244	5001-UP		115 mm		HIT-0352704	Bushing	31.27
	4310244	5001-UP		115 mm		HIT-0460004	Wear Ring	15.33
	4310244	5001-UP			170 mm	HIT-0420109	Wear Ring	12.62
	4310244	5001-UP			170 mm	HIT-0259307	Wear Ring	33.07

Hercules Bulldog and original equipment Hitachi kits may not include the necessary wear rings for your cylinder rebuild. Please ask your sales representative for a cross-reference if no complementary parts are listed.

Replacement Kits For

HITACHI

HITACHI

Excavators								
APPLICATION	CYL #	SERIAL #	CODE	ROD	BORE	KIT #	MISC	List \$
MODEL EX400-3, EX400LC-3, EX400H-3, EX400LCH-3								
BUCKET	4390024	ALL	P-UB-10	120 mm	170 mm	HIT-4438681		138.65
	4390024	ALL		120 mm		HIT-0450506	Bushing	35.10
	4390024	ALL			170 mm	HIT-0259307	Wear Ring	33.07
	4390024	ALL			170 mm	HIT-0420109	Wear Ring	12.62
	4390024	ALL		120 mm		HIT-0450508	Wear Ring	13.81
BUCKET (Long Arm)	9138785	5001-UP	P-UB-14	95 mm	145 mm	HIT-9123265		90.26
	9138785	5001-UP		95 mm		HIT-4284535	Bushing	27.64
	9138785	5001-UP			145 mm	HIT-4185249	Wear Ring	11.58
	9138785	5001-UP			145 mm	HIT-4185247	Wear Ring	25.18
BUCKET LH (Load Shvl)	4219781	5001-UP	P-UB-10	115 mm	150 mm	HIT-4255532		149.47
	4219781	5001-UP		115 mm		HIT-0352704	Bushing	31.27
	4219781	5001-UP		115 mm		HIT-0352708	Wear Ring	15.55
	4219781	5001-UP			150 mm	HIT-0237220	Wear Ring	21.98
	4219781	5001-UP			150 mm	HIT-0387305	Wear Ring	10.54
BUCKET RH (Load Shvl)	4219780	5001-UP	P-UB-10	115 mm	150 mm	HIT-4255532		149.47
	4219780	5001-UP		115 mm		HIT-0352704	Bushing	31.27
	4219780	5001-UP		115 mm		HIT-0352708	Wear Ring	15.55
	4219780	5001-UP			150 mm	HIT-0237220	Wear Ring	21.98
	4219780	5001-UP			150 mm	HIT-0387305	Wear Ring	10.54
DUMP (Load Shvl)	4219782	5001-UP	P-UB-10	65 mm	100 mm	HIT-4255533		62.02
	4219782	5001-UP		65 mm		HIT-0310604	Bushing	13.52
	4219782	5001-UP		65 mm		HIT-0387503	Wear Ring	11.83
	4219782	5001-UP			100 mm	HIT-0326005	Wear Ring	6.92
	4219782	5001-UP			100 mm	HIT-0254908	Wear Ring	28.05
LEVEL (Load Shvl)	4219779	5001-UP	P-UB-10	115 mm	170 mm	HIT-4236057		198.75
	4219779	5001-UP		115 mm		HIT-0352704	Bushing	31.27
	4219779	5001-UP		115 mm		HIT-0352708	Wear Ring	15.55
	4219779	5001-UP			170 mm	HIT-0259307	Wear Ring	33.07
	4219779	5001-UP			170 mm	HIT-0352712	Wear Ring	22.01
LOADING SHOVEL	4344048	5001-UP	P-U-10	65 mm	130 mm	HIT-4363078		82.26
	4344048	5001-UP		65 mm		HIT-0657704	Bushing	14.06
	4344048	5001-UP			130 mm	HIT-0657706	Wear Ring	39.02
MODEL EX400-3C, EX400LC-3C, EX450H-3C, EX450LCH-3C								
ARM	4310243	6001-UP	P-UB-10	130 mm	190 mm	HIT-4438679		192.66
	4310243	6001-UP		130 mm		HIT-0353004	Bushing	44.33
	4310243	6001-UP		130 mm		HIT-0417605	Wear Ring	23.59
	4310243	6001-UP			190 mm	HIT-0420307	Wear Ring	22.71
	4310243	6001-UP			190 mm	HIT-0242512	Wear Ring	34.39
BOOM LH	4310242	6001-UP	P-UB-10	115 mm	170 mm	HIT-4438672		228.88
	4310242	6001-UP		115 mm		HIT-0352704	Bushing	31.27
	4310242	6001-UP			170 mm	HIT-0420109	Wear Ring	12.62
	4310242	6001-UP			170 mm	HIT-0259307	Wear Ring	33.07
BOOM RH	4310242	6001-UP		115 mm		HIT-0460004	Wear Ring	15.33
	4310241	6001-UP	P-UB-10	115 mm	170 mm	HIT-4438672		228.88
	4310241	6001-UP		115 mm		HIT-0352704	Bushing	31.27

Hercules Bulldog and original equipment Hitachi kits may not include the necessary wear rings for your cylinder rebuild. Please ask your sales representative for a cross-reference if no complementary parts are listed.

Replacement Kits For

HITACHI

Excavators								
APPLICATION	CYL #	SERIAL #	CODE	ROD	BORE	KIT #	MISC	List \$
MODEL EX400-3C, EX400LC-3C, EX450H-3C, EX450LCH-3C								
BOOM RH	4310241	6001-UP			170 mm	HIT-0420109	Wear Ring	12.62
	4310241	6001-UP			170 mm	HIT-0259307	Wear Ring	33.07
	4310241	6001-UP		115 mm		HIT-0460004	Wear Ring	15.33
BUCKET	4310244	6001-UP	P-UB-10	115 mm	170 mm	HIT-4438672		228.88
	4310244	6001-UP		115 mm		HIT-0352704	Bushing	31.27
	4310244	6001-UP			170 mm	HIT-0259307	Wear Ring	33.07
	4310244	6001-UP			170 mm	HIT-0420109	Wear Ring	12.62
BUCKET (Long Arm)	4310244	6001-UP		115 mm		HIT-0460004	Wear Ring	15.33
	9138785	6001-UP	P-UB-14	95 mm	145 mm	HIT-9123265		90.26
	9138785	6001-UP		95 mm		HIT-4284535	Bushing	27.64
	9138785	6001-UP			145 mm	HIT-4185247	Wear Ring	25.18
LOADING SHOVEL	4344048	6001-UP	P-U-10	65 mm	130 mm	HIT-4363078		82.26
	4344048	6001-UP		65 mm		HIT-0657704	Bushing	14.06
	4344048	6001-UP			130 mm	HIT-0657706	Wear Ring	39.02
MODEL EX400-5, EX400LC-5, EX450LC-5, EX450LCH-5								
ARM	4310243	7001-UP	P-UB-10	130 mm	190 mm	HIT-4438679		192.66
	4310243	7001-UP		130 mm		HIT-0353004	Bushing	44.33
	4310243	7001-UP			190 mm	HIT-0420307	Wear Ring	22.71
	4310243	7001-UP		130 mm		HIT-0417605	Wear Ring	23.59
	4310243	7001-UP			190 mm	HIT-0242512	Wear Ring	34.39
BOOM LH	4310242	7001-UP	P-UB-10	115 mm	170 mm	HIT-4438672		228.88
	4310242	7001-UP		115 mm		HIT-0352704	Bushing	31.27
	4310242	7001-UP			170 mm	HIT-0420109	Wear Ring	12.62
	4310242	7001-UP			170 mm	HIT-0259307	Wear Ring	33.07
BOOM RH	4310242	7001-UP		115 mm		HIT-0460004	Wear Ring	15.33
	4310241	7001-UP	P-UB-10	115 mm	170 mm	HIT-4438672		228.88
	4310241	7001-UP		115 mm		HIT-0352704	Bushing	31.27
	4310241	7001-UP			170 mm	HIT-0259307	Wear Ring	33.07
BUCKET	4310241	7001-UP			170 mm	HIT-0420109	Wear Ring	12.62
	4310241	7001-UP		115 mm		HIT-0460004	Wear Ring	15.33
	4310244	7001-UP	P-UB-10	115 mm	170 mm	HIT-4438672		228.88
	4310244	7001-UP		115 mm		HIT-0352704	Bushing	31.27
	4310244	7001-UP		115 mm		HIT-0460004	Wear Ring	15.33
	4310244	7001-UP			170 mm	HIT-0259307	Wear Ring	33.07
	4310244	7001-UP			170 mm	HIT-0420109	Wear Ring	12.62
	4390024	7001-UP	P-UB-10	120 mm	170 mm	HIT-4438681		138.65
	4390024	7001-UP		120 mm		HIT-0450506	Bushing	35.10
	4390024	7001-UP		120 mm		HIT-0450508	Wear Ring	13.81
	4390024	7001-UP			170 mm	HIT-0420109	Wear Ring	12.62
BUCKET (Long Arm)	4390024	7001-UP			170 mm	HIT-0259307	Wear Ring	33.07
	9138785	7001-UP	P-UB-14	95 mm	145 mm	HIT-9123265		90.26
	9138785	7001-UP		95 mm		HIT-4284535	Bushing	27.64
	9138785	7001-UP			145 mm	HIT-4185249	Wear Ring	11.58
LOADING SHOVEL	9138785	7001-UP			145 mm	HIT-4185247	Wear Ring	25.18
	4344048	7001-UP	P-U-10	65 mm	130 mm	HIT-4363078		82.26

Hercules Bulldog and original equipment Hitachi kits may not include the necessary wear rings for your cylinder rebuild. Please ask your sales representative for a cross-reference if no complementary parts are listed.

Replacement Kits For

HITACHI

HITACHI

Excavators								
APPLICATION	CYL #	SERIAL #	CODE	ROD	BORE	KIT #	MISC	List \$
MODEL EX400-5, EX400LC-5, EX450LC-5, EX450LCH-5								
LOADING SHOVEL	4344048	7001-UP		65 mm		HIT-0657704	Bushing	14.06
	4344048	7001-UP			130 mm	HIT-0657706	Wear Ring	39.02
MODEL EX700, EX700H								
ARM	4218518	01003-UP	P-UB-10	150 mm	215 mm	HIT-4254042		258.59
	4253060	6/89-UP	P-UB-10	150 mm	215 mm	HIT-4266596		258.59
BOOM	4218516	01003-UP	P-UB-10	140 mm	200 mm	HIT-4254041		225.41
	4218517	01003-UP	P-UB-10	140 mm	200 mm	HIT-4254041		225.41
BUCKET	4251780	01003-UP	P-UB-10	130 mm	190 mm	HIT-4256119		212.93
	4253061	6/89-UP	P-UB-10	150 mm	215 mm	HIT-4266596		258.59
MODEL EX1000								
ARM	4157138	101-UP	P-U-10	150 mm	225 mm	HIT-4163898		218.16
	4157138	101-UP	P-UB-10	150 mm	225 mm	HIT-4171991		401.88
BOOM	4157139	101-UP	P-U-10	160 mm	240 mm	HIT-4163899		251.52
	4157139	101-UP	P-UB-10	160 mm	240 mm	HIT-4171990		465.39
BUCKET	4174020	101-UP	P-UB-10	160 mm	240 mm	HIT-4171990		465.39
	4193517	101-UP	P-UB-10	160 mm	240 mm	HIT-4171990		465.39
DUMP	4157143	101-UP	P-UB-10	80 mm	140 mm	HIT-4171993		197.78
	4157143	101-UP	P-U-10	80 mm	140 mm	HIT-4163901		100.53
LEVEL	4157142	101-UP	P-U-10	160 mm	240 mm	HIT-4163899		251.52
	4157142	101-UP	P-UB-10	160 mm	240 mm	HIT-4171990		465.39
TILT	4157140	101-UP	P-U-10	140 mm	190 mm	HIT-4163900		177.41
	4157140	101-UP	P-UB-10	140 mm	190 mm	HIT-4171992		275.55
MODEL EX1800								
DUMP	4248484		P-UB-10	110 mm	190 mm	HIT-4221872		318.07
MODEL EX3500								
DUMP			P-UB-10	130 mm	225 mm	HIT-4210676		459.40
MODEL UH07-3								
ARM			P-UB-5	85 mm	125 mm	HIT-4094458		139.84
BOOM			P-UB-5	85 mm	125 mm	HIT-4094457		130.06
BUCKET			I-U-5	70 mm	125 mm	HIT-4071694		79.74
MODEL UH07-5								
ARM			P-UB-5	90 mm	130 mm	HIT-4104127		166.78
BOOM			P-UB-5	85 mm	125 mm	HIT-4117741		138.50
BUCKET			P-UB-5	75 mm	125 mm	HIT-4117743		145.38
MODEL UH07-7								
ARM			P-UB-10	100 mm	140 mm	HIT-4153211		155.03
BOOM			P-UB-10	90 mm	130 mm	HIT-4153209		105.83
BUCKET			P-UB-10	80 mm	125 mm	HIT-4153213		137.24
MODEL UH009								
ARM			I-U-5	95 mm	150 mm	HIT-4064636		153.15
BOOM			I-U-5	90 mm	150 mm	HIT-4064635		98.26
BUCKET			I-U-5	90 mm	150 mm	HIT-4064635		98.26
MODEL UH010								
ARM			P-UB-5	105 mm	150 mm	HIT-4096959		308.35
BOOM			P-UB-5	95 mm	150 mm	HIT-4096957		304.75
BUCKET			P-UB-5	95 mm	150 mm	HIT-4096960		278.52

Hercules Bulldog and original equipment Hitachi kits may not include the necessary wear rings for your cylinder rebuild. Please ask your sales representative for a cross-reference if no complementary parts are listed.

Replacement Kits For

HITACHI

HITACHI

Excavators								
APPLICATION	CYL #	SERIAL #	CODE	ROD	BORE	KIT #	MISC	List \$
MODEL UH012								
ARM			P-U-5	110 mm	180 mm	HIT-4509364		281.54
BOOM			P-U-5	110 mm	180 mm	HIT-4509364		281.54
BUCKET			P-U-5	120 mm	180 mm	HIT-4509365		284.95
MODEL UH016								
ARM	3022991	005-009;053-069	P-UB-5	110 mm	170 mm	HIT-4153235		559.43
	3027628	001-165	P-UB-5	120 mm	190 mm	HIT-4162027		517.55
	3031888	166-UP	P-UB-10	120 mm	190 mm	HIT-4176980		207.50
	4167618	001-004;010-052;070-UP	P-UB-10	110 mm	170 mm	HIT-4167722		188.52
BOOM LH	3026175		P-UB-5	110 mm	170 mm	HIT-4162026	Old Style	535.71
	4167617		P-UB-10	110 mm	170 mm	HIT-4167721	New Style	192.17
BOOM RH	3026114		P-UB-5	110 mm	170 mm	HIT-4162026	Old Style	535.71
	4167616		P-UB-10	110 mm	170 mm	HIT-4167721	New Style	192.17
BUCKET	3026115	001-145	P-UB-5	110 mm	170 mm	HIT-4162028		535.71
	3027022	001-UP	P-UB-5	95 mm	150 mm	HIT-4150681		346.01
	3031889	146-UP	P-UB-10	110 mm	170 mm	HIT-4167721		192.17
DUMP	3024187	001-UP	P-UB-5	55 mm	100 mm	HIT-4144635		177.23
LEVEL	3025213	001-UP	P-UB-5	110 mm	170 mm	HIT-4153237		499.20
MODEL UH035								
ARM	4157138	002-UP	P-U-10	150 mm	225 mm	HIT-4163898		218.16
BOOM	4157139	002-UP	P-U-10	160 mm	240 mm	HIT-4163899		251.52
DUMP	4157143	002-UP	P-U-10	80 mm	140 mm	HIT-4163901		100.53
LEVEL	4157142	002-UP	P-U-10	160 mm	240 mm	HIT-4163899		251.52
TILT LH	4157141	002-UP	P-U-10	140 mm	190 mm	HIT-4163900		177.41
TILT RH	4157140	002-UP	P-U-10	140 mm	190 mm	HIT-4163900		177.41
MODEL UH045, UH061								
ARM			I-U-5	80 mm	130 mm	HIT-4101443		103.44
BOOM			I-U-5	70 mm	120 mm	HIT-4101442		78.40
BUCKET			I-U-5	70 mm	120 mm	HIT-4101442		78.40
MODEL UH083, UH083LC								
ARM	4132364	20051-UP	P-UB-5	100 mm	140 mm	HIT-4153205		282.24
	4132364	20001-20010	P-UB-5	100 mm	140 mm	HIT-4153205		282.24
	4153281	20011-20050	P-UB-10	100 mm	140 mm	HIT-4153211		155.03
BOOM LH	4128103	20001-20010	P-UB-5	85 mm	125 mm	HIT-4153203		201.95
	4153280	20011-20050	P-UB-10	90 mm	130 mm	HIT-4153209		105.83
BOOM RH	4153312	20051-UP	P-UB-5	85 mm	125 mm	HIT-4153203		201.95
	4128102	20001-20010	P-UB-5	85 mm	125 mm	HIT-4153203		201.95
	4153279	20011-20050	P-UB-10	90 mm	130 mm	HIT-4153209		105.83
BUCKET	4153311	20051-UP	P-UB-5	85 mm	125 mm	HIT-4153203		201.95
	4128105	20051-UP	P-UB-5	80 mm	125 mm	HIT-4153207		228.32
	4128105	20001-20010	P-UB-5	80 mm	125 mm	HIT-4153207		228.32
	4153282	20011-20050	P-UB-10	80 mm	125 mm	HIT-4153213		137.24
MODEL UH107								
ARM			P-UB-5	105 mm	150 mm	HIT-4096959		308.35
BOOM			P-UB-5	95 mm	150 mm	HIT-4096957		304.75
BUCKET			P-UB-5	95 mm	150 mm	HIT-4096960		278.52

Hercules Bulldog and original equipment Hitachi kits may not include the necessary wear rings for your cylinder rebuild. Please ask your sales representative for a cross-reference if no complementary parts are listed.

HITACHI

Replacement Kits For

HITACHI

Excavators								
APPLICATION	CYL #	SERIAL #	CODE	ROD	BORE	KIT #	MISC	List \$
MODEL UH122, UH122LC								
ARM	3011918	125	P-UB-5	105 mm	150 mm	HIT-4096958		285.00
	3015873	351-605	P-UB-5	105 mm	150 mm	HIT-4096959		308.35
	3019398	835-UP	P-UB-5	105 mm	150 mm	HIT-4122040		313.78
	3020009	606-834	P-UB-5	105 mm	150 mm	HIT-4117746		308.35
BOOM LH	3010528	125-605	P-UB-5	95 mm	150 mm	HIT-4096957		304.75
	3020012	606-835	P-UB-5	95 mm	150 mm	HIT-4117745		304.75
	3020973	836-UP	P-UB-5	95 mm	150 mm	HIT-4122039		315.16
BOOM RH	3010527	125-605	P-UB-5	95 mm	150 mm	HIT-4096957		304.75
	3020011	606-835	P-UB-5	95 mm	150 mm	HIT-4117745		304.75
	3020972	836-UP	P-UB-5	95 mm	150 mm	HIT-4122039		315.16
BUCKET	3010530	125-UP	P-UB-5	95 mm	150 mm	HIT-4096960		278.52
MODEL UH123								
ARM	4170628	3001-UP	P-UB-10	105 mm	150 mm	HIT-4163569		127.21
BOOM LH	4170627	3001-UP	P-UB-10	95 mm	150 mm	HIT-4179470		157.30
BOOM RH	4173626	3001-UP	P-UB-10	95 mm	150 mm	HIT-4179470		157.30
BUCKET	4170629	3001-UP	P-UB-10	95 mm	150 mm	HIT-4163573		157.04
MODEL UH172								
ARM	3015411	601-UP	P-UB-5	120 mm	190 mm	HIT-4101392		490.81
BOOM LH	3014038		P-UB-5	110 mm	170 mm	HIT-4094852		511.94
BOOM RH	3013801		P-UB-5	110 mm	170 mm	HIT-4094852		511.94
BUCKET	3014042	001-UP	P-UB-5	110 mm	170 mm	HIT-4094852		511.94
MODEL UH181								
ARM	3022991	005-009;053-069	P-UB-5	110 mm	170 mm	HIT-4153235		559.43
	3027628	001-165	P-UB-5	120 mm	190 mm	HIT-4162027		517.55
	3031888	166-UP	P-UB-10	120 mm	190 mm	HIT-4176980		207.50
	4167618	001-004;010-052	P-UB-10	110 mm	170 mm	HIT-4167722		188.52
	4167618	070-UP	P-UB-10	110 mm	170 mm	HIT-4167722		188.52
BOOM LH	3026175		P-UB-5	110 mm	170 mm	HIT-4162026		535.71
	4167617		P-UB-10	110 mm	170 mm	HIT-4167721		192.17
BOOM RH	3026114		P-UB-5	110 mm	170 mm	HIT-4162026		535.71
	4167616		P-UB-10	110 mm	170 mm	HIT-4167721		192.17
BUCKET	3026115	001-145	P-UB-5	110 mm	170 mm	HIT-4162028		535.71
	3027022	001-UP	P-UB-5	95 mm	150 mm	HIT-4150681		346.01
	3031889	146-UP	P-UB-10	110 mm	170 mm	HIT-4167721		192.17
DUMP	3024187	001-UP	P-UB-5	55 mm	100 mm	HIT-4144635		177.23
LEVEL	3025213	001-UP	P-UB-5	110 mm	170 mm	HIT-4153237		499.20
TILT	3022992	005-009;053-069	P-UB-5	110 mm	150 mm	HIT-4153236		353.07
	4167620	001-004;010-052;070-UP	P-UB-10	110 mm	140 mm	HIT-4167724		186.24
MODEL UH501								
ARM	4157138	002-UP	P-U-10	150 mm	225 mm	HIT-4163898		218.16
BOOM	4157139	002-UP	P-U-10	160 mm	240 mm	HIT-4163899		251.52
DUMP	4157143	002-UP	P-U-10	80 mm	140 mm	HIT-4163901		100.53
LEVEL	4157142	002-UP	P-U-10	160 mm	240 mm	HIT-4163899		251.52
TILT LH	4157141	002-UP	P-U-10	140 mm	190 mm	HIT-4163900		177.41
TILT RH	4157140	002-UP	P-U-10	140 mm	190 mm	HIT-4163900		177.41

Hercules Bulldog and original equipment Hitachi kits may not include the necessary wear rings for your cylinder rebuild. Please ask your sales representative for a cross-reference if no complementary parts are listed.

REPLACEMENT KITS FOR HITACHI

Part Number	Code (Pg. x)	Rod X Bore Size	List Price
HIT-4064635	I-U-5	90 X 150	\$ 98.26
HIT-4064636	I-U-5	95 X 150	153.15
HIT-4071694	I-U-5	70 X 125	79.74
HIT-4094457	P-UB-5	85 X 125	130.06
HIT-4094458	P-UB-5	85 X 125	139.85
HIT-4094852	P-UB-5	110 X 170	511.94
HIT-4096957	P-UB-5	95 X 150	304.75
HIT-4096958	P-UB-5	105 X 150	285.00
HIT-4096959	P-UB-5	105 X 150	308.34
HIT-4096960	P-UB-5	95 X 150	278.52
HIT-4101442	I-U-5	70 X 120	78.40
HIT-4101443	I-U-5	80 X 130	103.43
HIT-4104127	P-UB-5	90 X 130	166.78
HIT-4117741	P-UB-5	85 X 125	138.50
HIT-4117743	P-UB-5	75 X 125	145.38
HIT-4117745	P-UB-5	95 X 150	304.75
HIT-4117746	P-UB-5	105 X 150	308.34
HIT-4122039	P-UB-5	95 X 150	315.16
HIT-4122040	P-UB-5	105 X 150	313.77
HIT-4124367	P-UB-5	140 X 200	653.13
HIT-4125182	P-UB-5	95 X 150	315.16
HIT-4125183	P-UB-5	105 X 150	313.77
HIT-4144635	P-UB-5	55 X 100	177.23
HIT-4150681	P-UB-5	95 X 150	346.01
HIT-4153203	P-UB-5	85 X 125	201.95
HIT-4153205	P-UB-5	100 X 140	282.24
HIT-4153207	P-UB-5	80 X 125	228.31
HIT-4153209	P-UB-10	90 X 130	105.83
HIT-4153211	P-UB-10	100 X 140	155.04
HIT-4153213	P-UB-10	80 X 125	137.24
HIT-4153235	P-UB-5	110 X 170	559.44
HIT-4153236	P-UB-5	110 X 150	353.06
HIT-4153237	P-UB-5	110 X 170	499.20
HIT-4162026	P-UB-5	110 X 170	535.71
HIT-4162028	P-UB-5	110 X 170	535.71
HIT-4163569	P-UB-10	105 X 150	127.21
HIT-4163573	P-UB-10	95 X 150	157.05
HIT-4163898	P-U-10	150 X 225	218.17
HIT-4163899	P-U-10	160 X 240	251.52
HIT-4163900	P-U-10	140 X 190	177.41
HIT-4163901	P-U-10	80 X 140	100.53
HIT-4167721	P-UB-10	110 X 170	192.17
HIT-4167722	P-UB-10	110 X 170	188.52
HIT-4167724	P-UB-10	110 X 140	186.24
HIT-4171990	P-UB-10	160 X 240	465.39
HIT-4171991	P-UB-10	150 X 225	401.88
HIT-4171992	P-UB-10	140 X 190	275.56
HIT-4171993	P-UB-10	80 X 140	197.79
HIT-4176980	P-UB-10	120 X 190	207.51
HIT-4179470	P-UB-10	95 X 150	157.30

Part Number	Code (Pg. x)	Rod X Bore Size	List Price
HIT-4203830	P-UB-14	90 X 135	\$ 130.19
HIT-4203831	P-UB-10	100 X 145	141.22
HIT-4206018	P-UB-10	85 X 125	113.21
HIT-4206019	P-UB-10	95 X 135	167.19
HIT-4206020	P-UB-10	80 X 120	125.91
HIT-4206340	P-UB-10	70 X 95	88.41
HIT-4206343	P-UB-10	75 X 105	81.65
HIT-4206344	P-UB-10	80 X 115	92.78
HIT-4206345	P-UB-10	65 X 95	86.07
HIT-4210676	P-UB-10	130 X 225	459.40
HIT-4214722	P-UB-10	85 X 135	117.56
HIT-4216264P	P-UB-10	85 X 120	143.98
HIT-4221872	P-UB-10	110 X 190	318.06
HIT-4223636	P-UB-10	35 X 65	77.20
HIT-4236057	P-UB-10	115 X 170	198.75
HIT-4236058	P-UB-10	130 X 190	215.14
HIT-4254041	P-UB-10	140 X 200	225.41
HIT-4254042	P-UB-10	150 X 215	258.59
HIT-4255532	P-UB-10	115 X 150	149.46
HIT-4255533	P-UB-10	65 X 100	62.02
HIT-4256119	P-UB-10	130 X 190	212.93
HIT-4266596	P-UB-10	150 X 215	258.59
HIT-4286459	P-UB-10	70 X 105	77.88
HIT-4286463	P-UB-10	80 X 110	93.92
HIT-4286739	P-UB-10	65 X 95	86.09
HIT-4286774	P-UB-10	85 X 120	124.34
HIT-4286780	P-UB-10	95 X 130	128.66
HIT-4286784	P-UB-10	75 X 110	89.19
HIT-4320954	P-UB-10	95 X 150	121.80
HIT-4340620	P-UB-10	115 X 170	261.56
HIT-4363078	P-U-10	65 X 130	82.26
HIT-4364915	P-UB-10	85 X 120	125.96
HIT-4364916	P-UB-10	95 X 130	158.95
HIT-4369766	P-UB-10	65 X 95	70.31
HIT-4369767	P-UB-10	65 X 100	73.86
HIT-4369890	P-UB-10	75 X 110	108.53
HIT-4369893P	P-UB-10	80 X 115	116.37
HIT-4369901	P-UB-10	85 X 120	120.63
HIT-4369902	P-UB-10	85 X 125	192.74
HIT-4369914	P-UB-10	95 X 130	154.33
HIT-4369943	P-UB-10	105 X 145	167.87
HIT-4389719	P-UB-10	80 X 110	130.19
HIT-4389720	P-UB-10	85 X 115	147.65
HIT-4389721	P-UB-10	75 X 105	95.96
HIT-4438672	P-UB-10	115 X 170	228.88
HIT-4438679	P-UB-10	130 X 190	192.66
HIT-4438681	P-UB-10	120 X 170	138.65
HIT-4438758	P-UB-10	115 X 170	157.96
HIT-4509364	P-U-5	110 X 180	281.55
HIT-4509365	P-U-5	120 X 180	284.95

REPLACEMENT KITS FOR HITACHI

HITACHI

Part Number	Code (Pg. x)	Rod X Bore Size	List Price
HIT-9078843	P-UB-10	95 X 145	\$138.91
HIT-9078844	P-UB-14	105 X 150	207.89
HIT-9078845	P-UB-10	100 X 145	141.22
HIT-9078846	P-UB-10	110 X 165	204.03
HIT-9103842	P-UB-10	90 X 125	115.55
HIT-9103843	P-UB-14	100 X 135	151.37
HIT-9103844	P-UB-10	85 X 125	116.55
HIT-9123264	P-UB-14	110 X 165	113.66
HIT-9123265	P-UB-14	95 X 145	90.26
HIT-9156441	P-UB-14	100 X 135	100.64
HIT-9175562	P-UB-14	100 X 145	120.69
HIT-9175563	P-UB-14	110 X 165	146.84
HIT-9175564	P-UB-14	95 X 145	102.05
HIT-9178283	P-UB-14	90 X 125	86.29
HIT-9178284	P-UB-14	100 X 135	117.85
HIT-9178294	P-UB-14	85 X 125	90.34
HIT-9180579	P-UB-14	100 X 145	125.69
HIT-9180580	P-UB-14	90 X 135	101.09
HIT-9180581	P-UB-14	105 X 150	172.15
HIT-9180582	P-UB-14	115 X 170	150.26
HIT-9180587	P-UB-14	95 X 135	110.75

WIPERS

Part Number	Rod Diameter	List Price
HIT-4094867	55 mm	\$ 19.26
HIT-225610	65 mm	22.12
HIT-271308	70 mm	23.73
HIT-4036973	70 mm	8.56
HIT-240910	72 mm	25.52
HIT-4103699	75 mm	25.52
HIT-208607	80 mm	30.09
HIT-128607	85 mm	34.15
HIT-208307	85 mm	34.15
HIT-4039669	90 mm	9.09
HIT-4124849	90 mm	36.93
HIT-127208	95 mm	37.77
HIT-146409	95 mm	37.77
HIT-236920	95 mm	37.77
HIT-309206	95 mm	37.77
HIT-4039686	95 mm	12.46
HIT-4171482	95 mm	37.77
HIT-208507	100 mm	38.77
HIT-4074008	100 mm	24.33
HIT-4131730	100 mm	38.77
HIT-808507	100 mm	38.77
HIT-127409	105 mm	37.46
HIT-237216	105 mm	37.46
HIT-4171483	105 mm	37.46

WIPERS

Part Number	Rod Diameter	List Price
HIT-237310	110 mm	\$ 39.71
HIT-4505063	110 mm	39.71
HIT-352709	115 mm	35.14
HIT-4505954	120 mm	43.46
HIT-257006	130 mm	47.57
HIT-242506	140 mm	48.74
HIT-242707	150 mm	51.09
HIT-242306	160 mm	63.02

ROD U-SEALS

Part Number	Rod Diameter	List Price
HIT-4070039	55 mm	\$ 11.37
HIT-225611	65 mm	12.15
HIT-271309	70 mm	13.80
HIT-4508829	70 mm	16.59
HIT-127710	75 mm	16.72
HIT-240911	75 mm	15.21
HIT-208605	80 mm	16.92
HIT-128606	85 mm	19.03
HIT-208305	85 mm	18.39
HIT-4039668	90 mm	20.34
HIT-4094890	90 mm	20.41
HIT-4168226	90 mm	27.10
HIT-127207	95 mm	20.66
HIT-146407	95 mm	20.66
HIT-4034640	95 mm	20.66
HIT-4171484	95 mm	20.49
HIT-4070021	100 mm	22.41
HIT-4168227	100 mm	14.90
HIT-127408	105 mm	27.81
HIT-4069701	110 mm	29.88
HIT-4505060	110 mm	29.88
HIT-352706	115 mm	30.27
HIT-4069711	120 mm	34.70
HIT-4505951	120 mm	34.70
HIT-191405	130 mm	32.92
HIT-4094949	140 mm	37.30
HIT-4070027	150 mm	43.84
HIT-4105385	160 mm	52.25

REPLACEMENT PARTS FOR HITACHI

NOTE: Hitachi part numbers are used as a reference only. We do not imply that these kits are original REPLACEMENT PARTS.

BUFFER RINGS

Part Number	Rod Diameter	List Price
HIT-201003	55 mm	\$ 19.31
HIT-187305	60 mm	37.66
HIT-225613	65 mm	18.61
HIT-409104	65 mm	18.61
HIT-271311	70 mm	21.62
HIT-408804	70 mm	19.23
HIT-158102	75 mm	23.07
HIT-240913	75 mm	23.07
HIT-409605	75 mm	23.07
HIT-174506	80 mm	24.87
HIT-309305	80 mm	25.83
HIT-409004	80 mm	24.87
HIT-128603	85 mm	18.26
HIT-157801	85 mm	28.54
HIT-309005	85 mm	28.54
HIT-4108704	90 mm	29.16
HIT-4253560	90 mm	29.16
HIT-127205	95 mm	29.79
HIT-127221	95 mm	29.79
HIT-151902	95 mm	29.79
HIT-309205	95 mm	29.79
HIT-4171486	95 mm	29.79
HIT-208505	100 mm	30.92
HIT-4131728	100 mm	30.92
HIT-127407	105 mm	32.20
HIT-127419	105 mm	32.20
HIT-151703	105 mm	32.20
HIT-4171487	105 mm	32.20
HIT-165702	110 mm	33.61
HIT-336805	110 mm	33.61
HIT-4094814	110 mm	33.61
HIT-165903	120 mm	33.68
HIT-4094836	120 mm	33.68
HIT-353005	130 mm	34.33
HIT-380004	130 mm	34.33
HIT-187705	140 mm	34.66
HIT-379807	140 mm	34.66
HIT-242705	150 mm	36.59
HIT-292303	150 mm	36.59
HIT-379906	150 mm	36.59
HIT-336605	170 mm	46.28

PISTON SEALS

Part Number	Bore Diameter	List Price
HIT-310608	95 mm	\$ 24.87
HIT-201006	100 mm	30.06
HIT-240915	110 mm	30.62
HIT-258205	120 mm	31.35
HIT-128611	125 mm	37.84
HIT-223706	125 mm	31.35
HIT-4092193	125 mm	37.84
HIT-4124860	125 mm	46.59
HIT-4085439	130 mm	37.84
HIT-309210	135 mm	36.63
HIT-133505	140 mm	43.64
HIT-224106	140 mm	37.04
HIT-4185245	145 mm	57.42
HIT-127210	150 mm	48.65
HIT-127412	150 mm	48.65
HIT-187405	150 mm	48.65
HIT-237218	150 mm	39.83
HIT-4128769	150 mm	48.65
HIT-4171492	150 mm	62.02
HIT-165703	170 mm	95.15
HIT-4094809	170 mm	95.15
HIT-4170547	170 mm	49.41
HIT-105707	190 mm	96.92
HIT-161603	190 mm	96.92
HIT-242510	190 mm	56.22
HIT-380006	190 mm	56.22
HIT-379811	200 mm	57.91
HIT-379911	215 mm	58.93
HIT-392305	215 mm	58.93
HIT-242712	225 mm	64.69
HIT-242310	240 mm	65.95

WEAR RINGS

Part Number	OD X Width	List Price
HIT-0387503	70 X 9.5 mm	\$ 11.83
HIT-0310609	95 X 6 mm	6.21
HIT-0310610	95 X 6 mm	14.60
HIT-0254908	100 X 5.9 mm	28.05
HIT-0326005	100 X 6 mm	6.92
HIT-0310510	105 X 6 mm	65.29
HIT-0666808	105 X 6 mm	23.85
HIT-0298907	110 X 5.9 mm	30.61
HIT-0410005	110 X 7.9 mm	7.39
HIT-0667008	110 X 7.9 mm	7.53
HIT-410005	110 X 7.9 mm	7.53
HIT-0352708	115 X 14.8 mm	15.55
HIT-0310908	115 X 6 mm	15.66
HIT-0686405	115 X 7.9 mm	7.53
HIT-0450508	120 X 14.8 mm	13.81
HIT-0460004	120 X 15 mm	15.33
HIT-0667206	120 X 7.9 mm	8.10
HIT-309309	120 X 7.9 mm	8.10
HIT-0261308	120 X 8 mm	18.19
HIT-261308	120 X 8 mm	18.19
HIT-0309009	125 X 7.9 mm	8.11
HIT-0309309	125 X 7.9 mm	7.75
HIT-309009	125 X 7.9 mm	8.38
HIT-0223713	125 X 8 mm	18.94
HIT-4253562	125 X 9.9 mm	8.65
HIT-0657706	130 X 11.6 mm	39.03
HIT-0417605	130 X 14.8 mm	23.60
HIT-0409912	130 X 7.9 mm	9.55
HIT-0667409	130 X 7.9 mm	9.03
HIT-223707	130 X 7.9 mm	9.03
HIT-0254309	130 X 8 mm	19.29
HIT-223713	130 X 8 mm	19.29
HIT-4185248	135 X 14.8 mm	11.17
HIT-309211	135 X 7.9 mm	9.49
HIT-309212	135 X 8 mm	23.82
HIT-4252191	135 X 9.8 mm	11.89
HIT-224107	140 X 7.9 mm	9.85
HIT-224108	140 X 8 mm	19.91
HIT-4185249	145 X 14.8 mm	11.58

REPLACEMENT PARTS FOR HITACHI

NOTE: Hitachi part numbers are used as a reference only. We do not imply that these kits are original REPLACEMENT PARTS.

WEAR RINGS

Part Number	OD X Width	List Price
HIT-4194621	145 X 14.8 mm	\$ 11.35
HIT-0373413	145 X 7.9 mm	31.30
HIT-0492209	145 X 9.5 mm	10.45
HIT-4185247	145 X 9.7 mm	25.18
HIT-4194622	150 X 14.8 mm	12.44
HIT-0237220	150 X 8 mm	21.98
HIT-237220	150 X 8 mm	21.98
HIT-0387305	150 X 9.5 mm	10.54
HIT-237219	150 X 9.5 mm	10.54
HIT-4171490	150 X 9.7 mm	26.39
HIT-0352712	160 X 9.5 mm	22.02
HIT-4194623	165 X 15 mm	16.22
HIT-4194624	165 X 9.7 mm	53.34
HIT-4370064	170 X 14.8 mm	21.08
HIT-0420109	170 X 9.5 mm	12.61
HIT-259306	170 X 9.5 mm	11.71
HIT-352712	170 X 9.5 mm	11.71
HIT-0259307	170 X 9.7 mm	33.07
HIT-259307	170 X 9.7 mm	33.07
HIT-4370063	170 X 9.7 mm	33.07
HIT-0420307	190 X 14.8 mm	22.71
HIT-242511	190 X 15 mm	16.84
HIT-336808	190 X 15 mm	16.84
HIT-0242512	190 X 9.7 mm	34.40
HIT-242512	190 X 9.7 mm	34.40

ROD BUSHINGS

Part Number	Rod Diameter	List Price
HIT-0310604	65 mm	\$ 13.52
HIT-0657704	65 mm	14.06
HIT-0310504	75 mm	16.89
HIT-0309304	80 mm	19.46
HIT-4272960	85 mm	21.62
HIT-4272961	90 mm	20.85
HIT-0309204	95 mm	23.48
HIT-4171488	95 mm	47.38
HIT-4272962	95 mm	23.48
HIT-4284535	95 mm	27.63
HIT-4272963	100 mm	32.44
HIT-0373405	105 mm	27.68
HIT-4383093	105 mm	29.19
HIT-336804	110 mm	52.61
HIT-4284534	110 mm	52.61
HIT-0352704	115 mm	31.27
HIT-4370337	115 mm	41.34
HIT-0450506	120 mm	35.10
HIT-0353004	130 mm	44.33
HIT-317404	130 mm	49.36

O-RINGS

Part Number	Min Pkg Qty	List Price
HIT-127216	2	\$ 5.11
HIT-127218	3	2.22
HIT-127414	5	1.20
HIT-127417	2	4.58
HIT-128605	3	2.24
HIT-128609	3	2.14
HIT-128610	6	1.27
HIT-128612	3	2.52
HIT-136004	3	2.29
HIT-146423	10	.61
HIT-148310	1	9.11
HIT-150609	1	8.14
HIT-166010	3	2.52
HIT-186206	2	4.18
HIT-208509	2	2.85
HIT-808509	1	2.85
HIT-939306	10	.53
HIT-954488	3	2.82
HIT-955612	10	.61
HIT-984614	10	.53
HIT-985098	10	.53
HIT-1486206	2	4.18
HIT-4007528	1	9.74
HIT-4007535	1	7.38
HIT-4031027	2	4.09
HIT-4033451	2	4.22
HIT-4033751	2	4.22
HIT-4034653	2	4.22
HIT-4034654	2	5.11
HIT-4034655	1	7.48
HIT-4034656	2	4.58
HIT-4034657	5	1.91
HIT-4034658	10	.61
HIT-4035039	2	4.08
HIT-4037888	10	.61
HIT-4038304	2	4.01
HIT-4039611	1	7.80
HIT-4039657	2	5.11
HIT-4039659	1	7.38
HIT-4039678	2	2.84



REPLACEMENT PARTS FOR HITACHI

NOTE: Hitachi part numbers are used as a reference only. We do not imply that these kits are original REPLACEMENT PARTS.

O-RINGS

Part Number	Min Pkg Qty	List Price
HIT-4039679	2	\$ 5.11
HIT-4040565	3	2.34
HIT-4046608	2	3.93
HIT-4049492	3	2.24
HIT-4049494	2	4.01
HIT-4049565	3	2.34
HIT-4049568	2	2.62
HIT-4068626	2	4.09
HIT-4068628	4	1.21
HIT-4068632	2	3.93
HIT-4068682	2	3.93
HIT-4070046	3	2.97
HIT-4070049	10	.53
HIT-4087852	2	4.16
HIT-4094815	1	7.48
HIT-4094908	15	.40
HIT-4095999	3	2.24
HIT-4101722	3	2.22
HIT-4103701	3	1.86
HIT-4104498	15	.43
HIT-4105424	18	.33
HIT-4113165	1	8.40
HIT-4123447	3	2.29
HIT-4138931	18	.33
HIT-4140487	1	7.80
HIT-4140491	1	15.69
HIT-4253563	2	3.93
HIT-4505080	1	7.90
HIT-4505082	1	7.48
HIT-A810025	15	.43
HIT-A810085	4	1.40
HIT-A810125	3	2.24
HIT-A810130	3	2.29
HIT-A810155	2	3.96
HIT-A810165	2	4.58
HIT-A810170	2	4.58

O-RING 90 DUROMETER

Part Number	Min Pkg Qty	List Price
HIT-317406	1	\$ 15.83
HIT-317717	1	6.81
HIT-4007534	1	5.11
HIT-4104135	3	2.04
HIT-4123441	1	37.71
HIT-4203611	3	2.47
HIT-4506405	30	.20
HIT-4506408	25	.23
HIT-4506424	1	.42
HIT-4506428	12	.59
HIT-4506430	12	.70
HIT-A811025	1	.49
HIT-A811030	12	.49
HIT-A811035	10	.53
HIT-A811040	10	1.22
HIT-A811045	10	.85
HIT-A811050	8	.89
HIT-A811070	5	1.27
HIT-A811075	4	4.13
HIT-A811080	4	1.40
HIT-A811085	3	1.65
HIT-A811090	3	1.83
HIT-A811100	3	2.04
HIT-A811105	3	2.14
HIT-A811110	3	2.24
HIT-A811115	3	2.31
HIT-A811120	3	2.42
HIT-A811125	3	2.47
HIT-A811130	2	2.52
HIT-A811135	2	2.62
HIT-A811140	2	2.80
HIT-A811145	2	2.95
HIT-A811150	1	4.58
HIT-A811160	2	5.61
HIT-A811180	1	7.81
HIT-A811190	1	7.99
HIT-A812180	1	7.81

BACK-UP RINGS

Part Number	Min Pkg Qty	List Price
HIT-133704	1	\$ 9.85
HIT-133707	1	8.15
HIT-136006	1	9.21
HIT-146416	1	7.96
HIT-150610	1	18.66
HIT-166009	1	7.82
HIT-167721	1	7.17
HIT-208306	1	7.91
HIT-208308	1	7.25
HIT-208508	1	5.30
HIT-208522	1	9.21
HIT-208606	1	7.91
HIT-219405	1	6.02
HIT-223704	1	5.10
HIT-225612	1	6.56
HIT-236919	1	7.91
HIT-237215	1	9.21
HIT-237217	1	7.96
HIT-237309	1	9.21
HIT-239506	1	18.66
HIT-240912	1	6.56
HIT-242307	1	26.82
HIT-242507	1	7.74
HIT-242708	1	20.44
HIT-257007	1	7.97
HIT-257510	1	35.10
HIT-261310	1	5.10
HIT-262403	1	9.85
HIT-271310	1	6.56
HIT-298904	1	4.98
HIT-309207	1	7.58
HIT-310506	1	4.88
HIT-310606	1	4.76
HIT-317710	1	52.66
HIT-317718	1	7.22
HIT-336610	1	7.30
HIT-379908	1	20.11
HIT-403347	1	14.06
HIT-487862	1	7.82
HIT-1660019	1	7.82

HITACHI**BACK-UP RINGS**

Part Number	Min Pkg Qty	List Price
HIT-4007510	1	\$ 13.84
HIT-4033747	1	7.91
HIT-4034645	1	7.96
HIT-4034646	1	6.83
HIT-4034647	1	17.59
HIT-4035029	1	7.32
HIT-4035030	1	7.32
HIT-4039658	1	6.83
HIT-4039660	1	13.84
HIT-4061803	1	18.17
HIT-4061827	1	6.83
HIT-4067085	1	15.78
HIT-4067140	1	7.58
HIT-4068627	1	7.25
HIT-4070047	1	6.59
HIT-4087862	1	7.82
HIT-4094811	1	15.78
HIT-4094816	1	9.21
HIT-4094817	1	13.84
HIT-4103695	1	5.10
HIT-4103705	1	7.91
HIT-4104134	1	7.25
HIT-4113178	1	7.96
HIT-4113180	1	15.78
HIT-4170546	1	7.17
HIT-4170548	1	5.45
HIT-4505081	1	15.66
HIT-4505083	1	14.60
HIT-4505752	1	7.91
HIT-4509747	1	6.56
HIT-4510854	1	5.30
HIT-4510878	1	6.72

HUSKY BRUTE

Kit Number	Kit Reference Number	Code (Pg. x)	Rod X Bore Size	List Price
HB-790-030-004		P-V-8	2 X 4	\$ 40.26
HB-790-030-015		I-U-10, 12	2 X 5	37.49
HB-790-030-016		I-U-10, 12	2 X 5	52.64
HB-790-030-017		I-U-10, 12	2-1/2 X 6	50.15
HB-790-030-018		I-U-10, 12	2-1/2 X 6	71.85
HB-790-030-019		I-U-10, 12	3 X 6	73.09
HB-790-030-020		I-U-10, 12	2 X 5	64.49
HB-790-030-022		I-U-10, 12	3-1/2 X 7	85.93
HB-790-030-023		I-O-4	2-1/2 X 6	35.74
HB-790-030-024		5" Piston Kit		25.60
HB-790-035-501		P-OB-12	1-3/8 X 3-1/2	21.45
HB-790-035-502		5" Piston Kit		32.71
HB-790-035-504		P-OB-12	1-3/4 X 5	34.38
HB-790-035-507		I-U-5	3 X 6	58.18
HB-790-035-508		P-OB-12	2-1/2 X 6	62.12
HB-790-035-510		I-U-5	2-1/2 X 5	43.71
HB-790-035-519		I-V-9	2 X 4	53.91
HB-790-035-530		I-U-4	4 X 6-1/4	66.28
HB-790-035-531		I-U-5	4 X 7	87.19
HB-790-035-536		P-U-11	3-1/2 X 6	60.29
HB-790-120-019		I-U-5	4 X 7	73.09
HB-790-121-092		I-U-10, 12	2 X 5	52.64
HB-790-121-093		I-U-4	3-1/2 X 6	81.01
HB-790-121-097	790-121-097	I-U-4	4 X 7	63.03
HB-790-121-111		I-U-5	3 X 6	50.15
HB-790-122-302		6" Piston Kit		28.44
HB-790-200-011	790-200-011	I-U-5	2 X 3-1/2	32.47
HB-790-200-023		I-U-4	2-1/2 X 5	72.83
HBPMCK-D1192	790-035-50	P-OB-2,12	1-3/8 X 3-1/2	135.93
HBPMCK-F715	CYL. # F715	I-N-10,12	2 X 5	24.77
HBPMCK-F716	CYL. #716	I-U-10,12	2 X 5	52.64
HBPMCK-F717	790-030-018	I-N-10,12	2-1/2 X 6	50.03
HBPMCK-F718	CYL. #F718	I-U-10,12	2-1/2 X 6	71.03
HBPMCK-F721	790-030-019	I-U-10,12	3 X 6	73.09
HBPMCK-F726	CYL. #F726	I-U-10,12	2 X 5	64.84
HBPMCK-G968	790-030-022	I-U-10,12	3-1/2 X 7	88.44
HBPMCK-H163	CYL. #H163	I-N-4	2-1/2 X 6	42.64
HBPMCK-H182	790-030-024	I-N-4	2 X 5	34.55

HYCO TELESCOPIC CYLINDERS

IMPORTANT NOTE

When ordering hyco telescopic parts it is helpful to provide a model number and serial number. The serial number is stamped into the base of the cylinder body or is just above the cylinder port. The serial number is the first four or five digits of the number. The last three or four digits indicates the date of manufacture.

EXAMPLE 12345 10 93
 SERIAL # MONTH YEAR

70,000 SERIES SINGLE ACTING

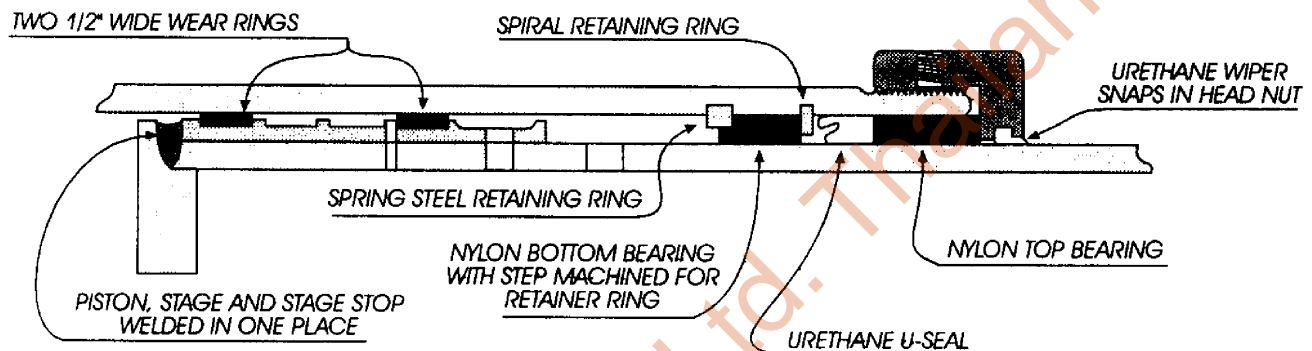

70,000 SERIES SINGLE ACTING

- PACKING:** Normally uses urethane u-seals, but may be retrofitted with vee packing. All sizes 1/4" c.s.
- WIPERS:** Urethane snap-in type.
- BEARINGS:** Nylon bearings. Outer bearing is flat on the top and bottom. Inner bearing is "trapped" between two retainers. The bottom side of the inner bearing is "step-cut" on the o.d. to pilot over snap ring. c/s = .245"
- PISTON:** Welded to stage. Uses 2 replaceable wear rings per stage.
- STAGE O.D.'s:** 3", 4", 5", 6", 7", 8-1/8", 9-3/8"
- SPECIAL INFO.:** Spring steel type snap ring serves as internal stop. Uses a spiral retainer to "trap" lower bearing.
- IDENTIFICATION:** Cylinder model number and serial number stamped on cylinder body near base of cylinder.
 Ex: 70000-815-180D

70,000 Series single action cylinders are manufactured to use urethane u-seals but may be retrofitted with a vee packing set if desired. We stock both types of packing for your convenience.

70,000 SERIES SINGLE ACTING PACKING SETS

We offer three types of packing for Hyco 70,000 series cylinders. Type 1 kits are identical to the original Hyco packing sets and utilize Parker u-seals. Type 2 kits are also identical to the Hyco sets but contain a lower cost Hallite manufactured u-seal. Type 3 kits contain a vee packing set retrofit for the original u-seal packing. The vee packing can be more effective in sealing an older cylinder with abrasive scoring or other surface blemishes.

HYCO TELESCOPIC CYLINDERS

70,000 SERIES CYLINDERS WITH K STYLE WIPER

HYCO

Part Number	Description	List Price
TYPE 1: OEM U-SEALS, WIPERS, NYLON BEARINGS AND RETAINER KITS		
HYOE-034-00070-300	3" Pack Kit	\$ 66.05
HYOE-034-00070-400	4" Pack Kit	87.33
HYOE-034-00070-500	5" Pack Kit	107.47
HYOE-034-00070-600	6" Pack Kit	120.65
HYOE-034-00070-700	7" Pack Kit	128.02
HYOE-034-00070-812	8-1/8" Pack Kit	194.66
HYOE-034-00070-938	9-3/8" Pack Kit	277.89
MULTIPLE STAGE KITS		
HYOE-034-00070-46	4 - 6"	\$ 283.83
HYOE-034-00070-47	4 - 7"	387.91
HYOE-034-00070-48-1/8	4 - 8-1/8"	613.14
HYOE-034-00070-49-3/8	4 - 9-3/8"	849.30
HYOE-034-00070-57	5 - 7"	325.80
HYOE-034-00070-58-1/8	5 - 8-1/8"	537.50
TYPE 2: U-SEALS, WIPERS, NYLON BEARINGS AND RETAINER KITS		
HY-034-00070-300	3" Pack Kit	\$ 42.76
HY-034-00070-400	4" Pack Kit	55.24
HY-034-00070-500	5" Pack Kit	62.60
HY-034-00070-600	6" Pack Kit	70.94
HY-034-00070-700	7" Pack Kit	81.51
HY-034-00070-812	8-1/8" Pack Kit	139.61
HY-034-00070-938	9-3/8" Pack Kit	189.59
MULTIPLE STAGE KITS		
HY-034-00070-46	4 - 6"	\$ 188.48
HY-034-00070-47	4 - 7"	258.34
HY-034-00070-48-1/8	4 - 8-1/8"	393.51
HY-034-00070-49-3/8	4 - 9-3/8"	589.89
HY-034-00070-57	5 - 7"	208.11
HY-034-00070-58-1/8	5 - 8-1/8"	341.53

Part Number	Description	List Price
TYPE 3: OPTIONAL VEE SETS, WIPERS, NYLON BEARINGS AND RETAINER KITS		
HY-034-00072-300	3" Pack Kit	\$ 36.86
HY-034-00072-400	4" Pack Kit	48.82
HY-034-00072-500	5" Pack Kit	58.00
HY-034-00072-600	6" Pack Kit	65.76
HY-034-00072-700	7" Pack Kit	74.08
HY-034-00072-812	8-1/8" Pack Kit	129.03
HY-034-00072-938	9-3/8" Pack Kit	166.36
MULTIPLE STAGE KITS		
HY-034-00072-46	4" - 6"	170.12
HY-034-00072-47	4" - 7"	243.25
HY-034-00072-48-1/8	4" - 8-1/8"	395.27
HY-034-00072-49-3/8	4" - 9-3/8"	611.37
HY-034-00072-57	5" - 7"	196.94
HY-034-00072-58-1/8	5" - 8-1/8"	311.12



HYCO TELESCOPIC CYLINDERS

70,000 SERIES CYLINDERS

Part Number	Description	List Price
TYPE 1: OEM U-SEALS, WIPERS, NYLON BEARINGS AND RETAINER KITS		
HYOE-B15252-300	3" Pack Kit	\$ 61.07
HYOE-B15252-400	4" Pack Kit	79.62
HYOE-B15252-500	5" Pack Kit	97.41
HYOE-B15252-600	6" Pack Kit	109.40
HYOE-B15252-700	7" Pack Kit	115.84
HYOE-B15252-812	8-1/8" Pack Kit	171.92
HYOE-B15252-938	9-3/8" Pack Kit	254.10
MULTIPLE STAGE KITS		
HYOE-B15252-46	4" - 6"	\$ 254.81
HYOE-B15252-47	4" - 7"	375.88
HYOE-B15252-48-1/8	4" - 8-1/8"	555.09
HYOE-B15252-57	5" - 7"	292.39
TYPE 2: U-SEALS, WIPERS, NYLON BEARINGS AND RETAINER KITS		
HY-B15252-300	3" Pack Kit	\$ 37.78
HY-B15252-400	4" Pack Kit	47.22
HY-B15252-600	6" Pack Kit	59.69
HY-B15252-700	7" Pack Kit	69.33
HY-B15252-812	8-1/8" Pack Kit	116.48
HY-B15252-938	9-3/8" Pack Kit	165.10
MULTIPLE STAGE KITS		
HY-B15252-46	4" - 6"	\$ 159.47
HY-B15252-47	4" - 7"	217.16
HY-B15252-48-1/8	4" - 8-1/8"	335.08
HY-B15252-49-3/8	4" - 9-3/8"	530.47
HY-B15252-500	5" Pack Kit	52.54
HY-B15252-57	5" - 7"	174.64
HY-B15252-58-1/8	5" - 8-1/8"	286.81

Part Number	Description	List Price
TYPE 3: OPTIONAL VEE SETS, WIPERS, NYLON BEARINGS AND RETAINER KITS		
HY-B15255-300	3" Pack Kit	\$ 31.87
HY-B15255-400	4" Pack Kit	41.12
HY-B15255-500	5" Pack Kit	47.95
HY-B15255-600	6" Pack Kit	54.52
HY-B15255-700	7" Pack Kit	61.91
HY-B15255-812	8-1/8" Pack Kit	106.33
HY-B15255-938	9-3/8" Pack Kit	139.33
MULTIPLE STAGE KITS		
HY-B15255-46	4" - 6"	\$ 141.11
HY-B15255-47	4" - 7"	202.07
HY-B15255-48-1/8	4" - 8-1/8"	336.25
HY-B15255-49-3/8	4" - 9-3/8"	451.15
HY-B15255-57	5" - 7"	163.46
HY-B15255-58-1/8	5" - 8-1/8"	260.50



HYCO TELESCOPIC CYLINDERS

70,000 SERIES CYLINDERS

INDIVIDUAL PARTS

HYCO

Part Number	Description	List Price
RETAINER RINGS		
HY-B9971-5.5	5" Retainer Ring	\$ 23.36
HY-B9971-6.5	6" Retainer Ring	23.84
HY-B9971-7.5	7" Retainer Ring	23.84
HY-B9971-862	8-1/8" Retainer Ring	64.45
HY-B9971-988	9-3/8" Retainer Ring	92.26
HY-083-50002-00350	3" Retainer Ring	22.49
HY-083-50002-00450	4" Retainer Ring	22.49
PISTON WEAR RINGS		
HY-10764-300	3-1/2" Nylon Piston Wear Ring	\$ 2.81
HY-10764-400	4-1/2" Nylon Piston Wear Ring	3.01
HY-10764-500	5-1/2" Nylon Piston Wear Ring	3.01
HY-10764-600	6-1/2" Nylon Piston Wear Ring	3.95
HY-10764-700	7-1/2" Nylon Piston Wear Ring	3.95
HY-10764-812	8-5/8" Nylon Piston Wear Ring	7.08
HY-10764-938	9-7/8" Nylon Piston Wear Ring	13.32
MISCELLANEOUS PARTS		
HY-A2688	Manual Bleeder Valve	\$ 2.48
HY-A20419	Set Screw for Headnut	.90
HY-A20420	Nylon Slug for Headnut	.45
INDIVIDUAL WIPERS		
HY-080-0005-300	3" Wiper	\$ 4.98
HY-080-0005-400	4" Wiper	7.71
HY-080-0005-500	5" Wiper	10.06
HY-080-0005-600	6" Wiper	11.25
HY-080-0005-700	7" Wiper	12.18
HY-080-0005-800	8" Wiper	26.22
HY-080-0005-812	8-1/8" Wiper	22.67
HY-080-0005-912	9-1/8" Wiper	39.50
HY-080-0005-938	9-3/8" Wiper	42.05
MULTIPLE STAGE WIPER KITS		
HY-080-0005-46	4" - 6"	\$ 30.09
HY-080-0005-47	4" - 7"	42.26
HY-080-0005-48-1/8	4" - 7" & 8-1/8"	65.39
HY-080-0005-49-1/8	4" - 8" & 9-1/8"	109.30
HY-080-0005-49-3/8	4" - 7", 8-1/8" & 9-3/8"	109.36
HY-080-0005-57	5" - 7"	34.56
HY-080-0005-58-1/8	5" - 7" & 8-1/8"	57.69

CAUTION:
Getting the correct Hyco headnut can be a problem. If you are unsure, call our sales department. Headnuts are measured at the I.D. of the wiper.

Part Number	Size - Wiper I.D.	List Price
HEADNUTS		
HY-011-11001-125	9-3/8" Headnut	\$ 204.33
HY-011-39001-125	3" Headnut	68.25
HY-011-49003-125	4" Headnut	70.36
HY-011-59002-125	5" Headnut	71.59
HY-011-69002-125	6" Headnut	86.21
HY-011-79002-125	7" Headnut	119.67
HY-011-93001-125	8-1/8" Headnut	203.38

Part Number	Description	List Price
BEARINGS		
HY-B12075-3	3" Bearing	\$ 7.01
HY-B12075-4	4" Bearing	7.01
HY-B12075-5	5" Bearing	7.37
HY-B12075-6	6" Bearing	8.72
HY-B12075-7	7" Bearing	9.49
HY-B12075-8	8" Bearing	11.49
HY-B12075-8.12	8-1/8" Bearing	32.79
HY-B12075-9.12	9-1/8" Bearing	41.65
HY-B12075-9.38	9-3/8" Bearing	36.64

U-SEALS		
HYOE-085-00001-0300	3" U-SEAL	\$ 31.41
HYOE-085-00001-0400	4" U-SEAL	49.42
HYOE-085-00001-0500	5" U-SEAL	61.52
HYOE-085-00001-0600	6" U-SEAL	68.64
HYOE-085-00001-0700	7" U-SEAL	69.81
HYOE-085-00001-0812	8-1/8" U-SEAL	80.76



HYCO TELESCOPIC CYLINDERS

IMPORTANT NOTE

When ordering hyco telescopic parts it is helpful to provide a model number and serial number. The serial number is stamped into the base of the cylinder body or is just above the cylinder port. The serial number is the first four or five digits of the number. The last three or four digits indicates the date of manufacture.

EXAMPLE 12345 10 93
SERIAL # MONTH YEAR

30,000 SERIES SINGLE ACTING MANUFACTURED AFTER AUGUST 1, 1981

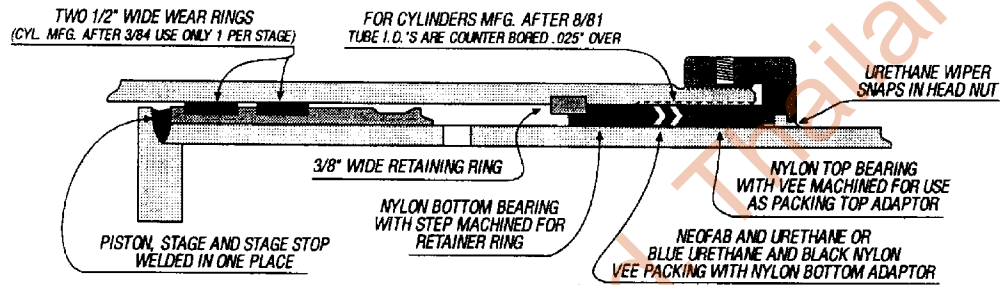

- PACKING:** Vee packing. Outer bearing serves as top adaptor for vee set. Note: Packing area is .025" over nominal bore. There is a "step" above the retainer ring groove where the bore dimension returns to nominal size.
- WIPERS:** Urethane snap-in type.
- BEARINGS:** Glass filled nylon. Outer bearing serves as top adaptor for vee set. Inner bearing is "step cut" on o.d. to pilot over snap ring.
- PISTON:** Welded to stage. Uses 1/2" wide replaceable wear rings as bearings. Cylinders manufactured 3/84 and before use 2 wear rings per stage. Cylinders manufactured after 3/84 use 1 per stage.
- STAGE O.D.'s:** 3", 4", 5", 6", 7", 8", 8-1/8", 8-1/4", 9-1/8", 9-3/8"
- SPECIAL INFO.:** Packing area bore diameter is .025" over nominal dimension. 3/8" thick spring steel snap ring serves as internal stop.
- IDENTIFICATION:** Cylinder model number and serial number stamped on cylinder body near base of cylinder.
Ex: 30001-85-220

The plungers and cylinder tube assembly have a "step" on the inside diameter above retaining ring groove. As a result packing surface is .025" over the plunger base I.D.. Pack sets contain wiper, vee packing, glass filled nylon top & bottom bearings, retainer rings are 3/8" wide, piston guide rings 1/2" wide, cylinders manufactured after 3/84 may only use one wear ring per stage.

Part Number	Description	List Price
VEE PACKING, BUSHING AND WIPER KITS		
HY-14750-300	3" Pack Kit	\$ 26.32
HY-14750-400	4" Pack Kit	26.32
HY-14750-500	5" Pack Kit	26.93
HY-14750-600	6" Pack Kit	31.39
HY-14750-700	7" Pack Kit	52.18
HY-14750-800	8" Pack Kit	64.47
HY-14750-812	8-1/8" Pack Kit	85.22
HY-14750-825	8-1/4" Pack Kit	92.53
HY-14750-912	9-1/8" Pack Kit	83.85
HY-14750-938	9-3/8" Pack Kit	83.85

Part Number	Description	List Price
VEE PACKING, BUSHING AND WIPER KITS		
HY-14750-46	4 - 6" Pack Kit	\$ 84.64
HY-14750-47	4 - 7" Pack Kit	136.81
HY-14750-48	4 - 8" Pack Kit	201.28
HY-14750-482	4 - 8-1/4" Pack Kit	229.34
HY-14750-57	5 - 7" Pack Kit	110.49
HY-14750-58	5 - 8" Pack Kit	174.97
MAJOR REPAIR KITS		
Contain vee packing, bushings, wear rings, retainer rings and wipers.		
HY-MRK-14750-46	4" - 6"	\$ 185.46
HY-MRK-14750-47	4" - 7"	271.26
HY-MRK-14750-48	4" - 8"	375.23

HYCO TELESCOPIC CYLINDERS

70,000 SERIES CYLINDERS

INDIVIDUAL PARTS

HYCO

Part Number	Description	List Price
RETAINER RINGS		
HY-B9971-3.5	3" Retainer Ring	\$ 44.06
HY-B9971-4.5	4" Retainer Ring	23.01
HY-B9971-5.5	5" Retainer Ring	23.36
HY-B9971-6.5	6" Retainer Ring	23.84
HY-B9971-7.5	7" Retainer Ring	23.84
HY-B9971-8.5	8" Retainer Ring	50.49
HY-B9971-862	8-1/8" Retainer Ring	64.45
HY-B9971-900	8-1/4" Retainer Ring	105.83
HY-B9971-962	9-1/8" Retainer Ring - S.A.	94.11
HY-B9971-988	9-3/8" Retainer Ring	92.26
PISTON WEAR RINGS		
HY-10764-300	3-1/2" Nylon Piston Wear Ring	\$ 2.81
HY-10764-400	4-1/2" Nylon Piston Wear Ring	3.01
HY-10764-500	5-1/2" Nylon Piston Wear Ring	3.01
HY-10764-600	6-1/2" Nylon Piston Wear Ring	3.95
HY-10764-700	7-1/2" Nylon Piston Wear Ring	3.95
HY-10764-800	8-1/2" Nylon Piston Wear Ring	4.75
HY-10764-812	8-5/8" Nylon Piston Wear Ring	7.08
HY-10764-825	9" Nylon Piston Wear Ring	7.60
HY-10764-900	9-3/4" Nylon Piston Wear Ring	8.12
HY-10764-938	9-7/8" Nylon Piston Wear Ring	13.32
PISTON WEAR RING KITS		
HY-10764-46	4-1/2" - 6-1/2" Kit (1 ea. size)	\$ 11.25
HY-10764-47	4-1/2" - 7-1/2" Kit (1 ea. size)	15.35
HY-10764-48	4-1/2" - 8-1/2" Kit (1 ea. size)	20.35
HY-10764-48.2	4-1/2" - 9" Kit (1 ea. size)	20.57
HY-10764-49	4-1/2" - 9-3/4" Kit (1 ea. size)	28.51
HY-10764-57	5-1/2" - 7-1/2" Kit (1 ea. size)	11.74
HY-10764-58	5-1/2" - 8-1/2" Kit (1 ea. size)	16.75
MISCELLANEOUS PARTS		
HY-ABV100	Automatic Bleeder Valve (For cylinders MFG prior to 1-1-88)	\$ 41.52
HY-ABV103	Automatic Bleeder Valve with S.A.E. O-Ring Seals (For cylinders MFG after 1-1-88)	41.52
HY-A20419	Set Screw for Headnut	.90
HY-A20420	Nylon Slug for Headnut	.45
HY-A20866	Nylon Slug & Set Screw	1.43

HEADNUTS

CAUTION:

Getting the correct Hyco headnut can be a problem. If you are unsure, call our sales department. Headnuts are measured at the I.D. of the wiper.

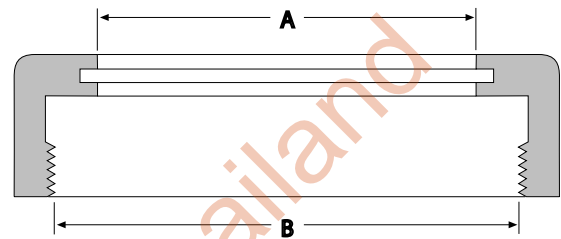

Part Number	"A" Wiper I.D.	"B" Thread I.D.	Threads/Inch	List Price
HY-A2527	3"	3.840"	12	\$ 68.25
HY-A2217	4"	4.840"	12	70.36
HY-A2216	5"	5.840"	12	71.59
HY-A2215	6"	6.840"	12	86.21
HY-A2406	7"	7.840"	12	119.67
HY-A3535	7" Headnut			178.83
HY-A20621	8"	9.020"	12	136.36
(For 30,000 Series prior to 9-1-87)				
HY-A22747	8"	8.990"	12	225.45
(For 30,000 Series after 9-1-87 and for threading on all 9-1/8" Stages)				
HY-A20558	8-1/8"	9.220"	12	203.38
HY-A3534	8-1/4" Headnut			223.83
HY-A22746	9-1/8"	10.170"	12	203.12
(For 30,000 Series after 9/81)				
HY-A20599	9-3/8"	10.670"	12	204.33

NOTE:

REPLACEMENT STAGES AVAILABLE UPON REQUEST.
CYLINDER SERIAL NUMBER IS IMPORTANT

HYCO TELESCOPIC CYLINDERS

30,000 SERIES SINGLE ACTING

MANUFACTURED BEFORE AUGUST 1, 1981

20,000 SERIES DOUBLE ACTING

ALL

TWO 1/2" WIDE WEAR RINGS
(CYL. MFG. AFTER 3/84 USE ONLY 1 PER STAGE)

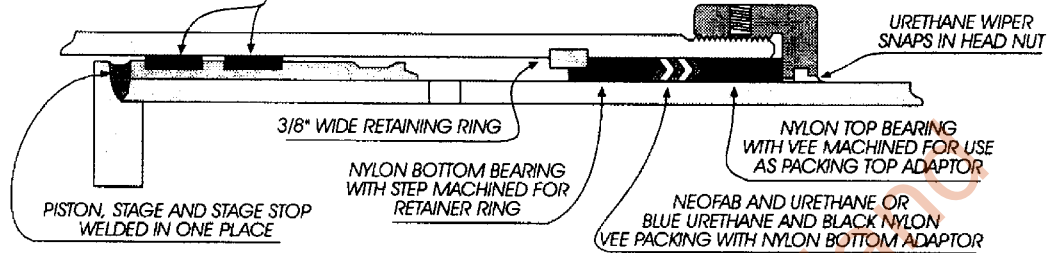

HYCO 30,000 SERIES

- PACKING:** Vee packing. Outer bearing serves as top adaptor for vee set. All packing is 1/4" cross section, except 9" stage has 3/8" c/s packing and 9-1/8" stage has 5/16" c/s packing.
- WIPERS:** Urethane snap-in type.
- BEARINGS:** Glass filled nylon. Outer bearing serves as top adaptor for vee set. Inner bearing is "step-cut" on o.d. to pilot over snap ring.
- PISTON:** Welded to stage. Uses 1/2" wide replaceable wear rings as bearings.
- STAGE O.D.'s:** 3", 4", 5", 6", 7", 8", 8-1/8", 8-1/4", 9", 9-1/8", 9-3/8"
- SPECIAL INFO.:** 3/8" spring steel snap ring serves as internal stop.
- IDENTIFICATION:** Cylinder model number and serial number stamped on cylinder body near base of cylinder. Ex: 30001-85-220

HYCO 20,000 SERIES DOUBLE ACTION

- PACKING:** Vee packing with bottom adaptor. 4" through 8" sizes 1/4" c.s.; 9" is 3/8" c.s.; 9-1/8" is 5/16".
- WIPERS:** Urethane snap-in type.
- BEARINGS:** Glass filled nylon. Top bearing serves as top adaptor for vee packing. Inner bearing is step-cut to pilot over snap ring.
- PISTON:** Welded to stage. Uses 1, 1/2" wide nylon wear ring and 2 iron piston rings in separate grooves.
- STAGE O.D.'s:** 3", 4", 5", 6", 7", 8", 9", 9-1/8"
- SPECIAL INFO.:** 3/8" spring steel snap ring serves as internal stop.
- IDENTIFICATION:** Cylinder model number and serial number stamped on cylinder body near base.

Part Number	Description	List Price
VEE PACKING, NYLON TOP & BOTTOM BEARINGS AND WIPER KITS		
HY-14411-300N	3" Pack Kit	\$ 23.31
HY-14411-400N	4" Pack Kit	23.31
HY-14411-500N	5" Pack Kit	32.37
HY-14411-600N	6" Pack Kit	33.99
HY-14411-700N	7" Pack Kit	44.11
HY-14411-800N	8" Pack Kit	66.81
HY-14411-812N	8-1/8" Pack Kit	92.97
HY-14411-825N	8-1/4" Pack Kit	125.81
HY-14411-900N	9" Pack Kit	143.60
HY-14411-912N	9-1/8" Pack Kit	129.24
HY-14411-938N	9-3/8" Pack Kit	123.41
MULTIPLE STAGE KITS		
HY-14411-46N	4" - 6" Pack Kit	\$ 89.68
HY-14411-47N	4" - 7" Pack Kit	133.77
HY-14411-48N	4" - 8" Pack Kit	200.56
HY-14411-491N	4" - 9-1/8" Pack Kit	329.81
HY-14411-49N	4" - 9" Pack Kit	344.17

Part Number	Description	List Price
VEE PACKING, BRONZE TOP BEARING, AND NYLON BOTTOM BEARING AND WIPER KITS		
HY-14411-300B	3" Pack Kit Hytrel & Fab Vees	\$ 30.04
HY-14411-400B	4" Pack Kit Hytrel & Fab Vees	32.32
HY-14411-500B	5" Pack Kit Hytrel & Fab Vees	36.29
HY-14411-600B	6" Pack Kit Hytrel & Fab Vees	43.05
HY-14411-700B	7" Pack Kit Hytrel & Fab Vees	56.57
HY-14411-800B	8" Pack Kit Hytrel & Fab Vees	72.26
HY-14411-812B	8-1/8" Pack Kit Hytrel & Fab Vees	97.84
HY-14411-825B	8-1/4" Pack Kit Hytrel & Fab Vees	126.13
HY-14411-900B	9" Pack Kit Hytrel & Fab Vees	146.48
HY-14411-912B	9-1/8" Pack Kit Hytrel & Fab Vees	133.14
HY-14411-938B	9-3/8" Pack Kit Hytrel & Fab Vees	128.15
Part Number	Stages	List Price
MAJOR REPAIR KITS - SINGLE ACTING		
Contains vee packing, bushings, wear rings, retainer rings and wipers.		
HY-MRK-14411-46	4" - 6"	\$ 178.35
HY-MRK-14411-47	4" - 7"	252.83
HY-MRK-14411-48	4" - 8"	354.11

HYCO TELESCOPIC CYLINDERS

30,000 SERIES CYLINDERS & 20,000 SERIES CYLINDERS

(MANUFACTURED BEFORE AUGUST 1, 1981)

(ALL)

Part Number	Description	List Price
RETAINER RINGS		
HY-B9971-3.5	3" Retainer Ring	\$ 44.06
HY-B9971-4.5	4" Retainer Ring	23.01
HY-B9971-5.5	5" Retainer Ring	23.36
HY-B9971-6.5	6" Retainer Ring	23.84
HY-B9971-7.5	7" Retainer Ring	23.84
HY-B9971-8.5	8" Retainer Ring	50.49
HY-B9971-862	8-1/8" Retainer Ring	64.45
HY-B9971-900	8-1/4" Retainer Ring	105.83
HY-B9971-962	9-1/8" Retainer Ring	94.11
HY-B9971-970	9-1/8" Retainer Ring - D.A.	148.24
HY-B9971-988	9-3/8" Retainer Ring	92.26
PISTON WEAR RINGS		
HY-10764-300	3-1/2" Nylon Piston Wear Ring	\$ 2.81
HY-10764-400	4-1/2" Nylon Piston Wear Ring	3.01
HY-10764-500	5-1/2" Nylon Piston Wear Ring	3.01
HY-10764-600	6-1/2" Nylon Piston Wear Ring	3.95
HY-10764-700	7-1/2" Nylon Piston Wear Ring	3.95
HY-10764-800	8-1/2" Nylon Piston Wear Ring	4.75
HY-10764-812	8-5/8" Nylon Piston Wear Ring	7.08
HY-10764-825	9" Nylon Piston Wear Ring	7.60
HY-10764-900	9-3/4" Nylon Piston Wear Ring	8.12
HY-10764-938	9-7/8" Nylon Piston Wear Ring	13.32
PISTON WEAR RING KITS		
HY-10764-46	4-1/2" - 6-1/2" Kit (1 ea. size)	\$ 11.25
HY-10764-47	4-1/2" - 7-1/2" Kit (1 ea. size)	15.35
HY-10764-48	4-1/2" - 8-1/2" Kit (1 ea. size)	20.35
HY-10764-48.2	4-1/2" - 9" Kit (1 ea. size)	20.57
HY-10764-49	4-1/2" - 9-3/4" Kit (1 ea. size)	28.51
HY-10764-57	5-1/2" - 7-1/2" Kit (1 ea. size)	11.74
HY-10764-58	5-1/2" - 8-1/2" Kit (1 ea. size)	16.75
CAST IRON PISTON RINGS FOR DOUBLE ACTING CYLINDERS 1/2" WIDE		
HY-B12071-3	3-1/2 Cast Iron Piston Ring	\$ 38.64
HY-B12071-4	4-1/2 Cast Iron Piston Ring	18.27
HY-B12071-49	4-1/2-9-3/4 Cast Iron Piston Ring Kit	335.92
HY-B12071-5	5-1/2 Cast Iron Piston Ring	22.04
HY-B12071-6	6-1/2 Cast Iron Piston Ring	25.76
HY-B12071-7	7-1/2 Cast Iron Piston Ring	28.23
HY-B12071-8	8-1/2 Cast Iron Piston Ring	31.86
HY-B12071-812	8-5/8 Cast Iron Piston Ring	68.66
HY-B12071-9	9-3/4 Cast Iron Piston Ring	33.80
HY-B12071-938	9-7/8 Cast Iron Piston Ring	68.66

Part Number	Description	List Price
MISCELLANEOUS PARTS		
DD-HA 2401	2" ID X 2" Wide Pin Eye Bushing	\$ 37.47
HY-A20419	Set Screw for Headnut	.90
HY-A20420	Nylon Slug for Headnut	.45
HY-A20866	Nylon Slug & Set Screw	1.43
HY-A2688	1/8" NPT Manual Bleeder Valve	2.48
HY-ABV100	Automatic Bleeder Valve	41.52

HEADNUTS

CAUTION:
Getting the correct Hyco headnut can be a problem. If you are unsure, call our sales department. Headnuts are measured at the I.D. of the wiper.

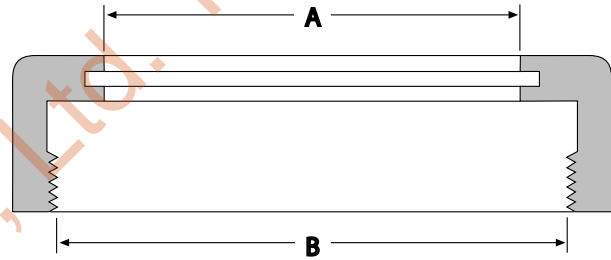

Part Number	"A" Wiper I.D.	"B" Thread I.D.	Threads/Inch	List Price
HY-A2527	3"	3.840"	12	\$ 68.25
HY-A2217	4" Headnut			70.36
HY-A2216	5"	5.840"	12	71.59
HY-A2215	6"	6.840"	12	86.21
HY-A2406	7"	7.840"	12	119.67
HY-A3535	7"	8.100"	12	178.83
(For threading on 8-1/4" Stage)				
HY-A22747	8"	8.990"	12	225.45
(For 30,000 Series after 9-1-87 and for threading on all 9-1/8" Stages)				
HY-A20621	8"	9.020"	12	136.36
(For 30,000 Series prior to 9-1-87)				
HY-A3534	8-1/4"	9.780"	12	223.83
HY-A20558	8-1/8"	9.220"	12	203.38
HY-A22483	9-1/8"		12	171.30
HY-A22746	9-1/8"	10.170"	12	203.12
(For 30,000 Series after 9/81)				
HY-A20599	9-3/8"	10.670"	12	204.33

HYCO TELESCOPIC CYLINDERS

20,000 SERIES CYLINDERS WITH K-STYLE WIPERS

Part Number	Description	List Price
MAJOR REPAIR KITS - SINGLE ACTING		
HY-MRK-034-00020-46	4" - 6" Pack Kit	\$ 207.48
HY-MRK-034-00020-47	4" - 7" Pack Kit	294.13
HY-MRK-034-00020-48	4" - 8" Pack Kit	412.99
VEE PACKING, BRONZE TOP & NYLON BOTTOM BEARINGS AND 2 WIPER KITS		
HY-034-00020-300B	3" Pack Kit	\$ 35.02
HY-034-00020-400B	4" Pack Kit	39.25
HY-034-00020-500B	5" Pack Kit	46.35
HY-034-00020-600B	6" Pack Kit	54.29
HY-034-00020-700B	7" Pack Kit	68.77
HY-034-00020-800B	8" Pack Kit	94.68
HY-034-00020-812B	8.12" Pack Kit	120.97
HY-034-00020-912B	9.12" Pack Kit	158.59
HY-034-00020-938B	9.38" Pack Kit	153.17

Part Number	Description	List Price
VEE PACKING, NYLON TOP & BOTTOM BEARINGS AND 2 WIPER KITS		
HY-034-00020-300N	3" Pack Kit	\$ 28.29
HY-034-00020-400N	4" Pack Kit	31.02
HY-034-00020-500N	5" Pack Kit	42.54
HY-034-00020-600N	6" Pack Kit	45.24
HY-034-00020-700N	7" Pack Kit	56.31
HY-034-00020-800N	8" Pack Kit	89.23
HY-034-00020-812N	8.12" Pack Kit	116.10
HY-034-00020-912N	9.12" Pack Kit	154.69
HY-034-00020-938N	9.38" Pack Kit	148.86
MULTIPLE STAGE KITS		
HY-034-00020-46N	4" - 6" Pack Kit	\$ 118.69
HY-034-00020-47N	4" - 7" Pack Kit	175.11
HY-034-00020-48N	4" - 8" Pack Kit	258.89
HY-034-00020-491N	4" - 9-1/8" Pack Kit	393.01



KINGSEAL CO., LTD. THAILAND

46/152-153 Moo 3 Sri Saman Road
Baan Mai Pakkret, Nonthaburi Thailand 11120

Tel: +662 9617534 to 6

Fax: +662 9617540

Email: intlsales@kingseal.co.th / kingsealmail@gmail.com

Website: <http://www.kingseal.co.th>

HYCO TELESCOPIC CYLINDERS

10,000 SERIES CYLINDER CYLINDERS

MANUFACTURED FROM JULY, 1974 THROUGH AUGUST, 1976

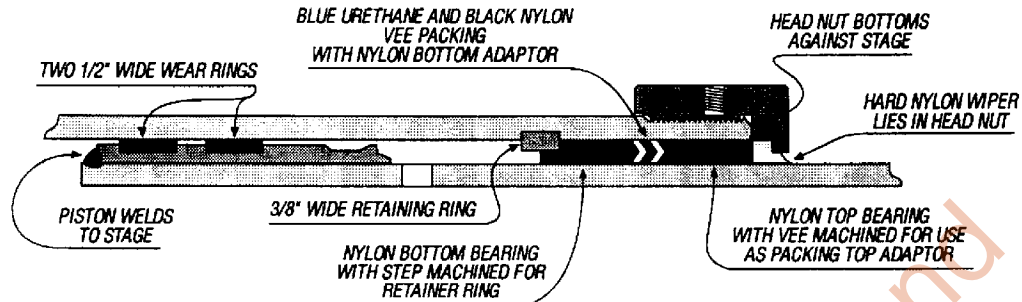

- PACKING:** Vee packing. Outer bearing serves as top adaptor for vee set.
- WIPERS:** Hard black nylon. Does NOT snap into a groove. Wiper is "trapped" between head nut and top bearing.
- BEARINGS:** Glass filled nylon. Outer bearing serves as top adaptor for vee set. Inner bearing is "step-cut" to pilot over snap ring.
- PISTON:** Welded to stage. Uses 2 replaceable 1/2" wide wear rings. Pistons are open through the bottom; they have no "plug", so a smaller stage will pass out through the bottom of the piston on a larger stage when the headnut is removed and the stages are removed from the cylinder body.
- STAGE O.D.s:** 3", 4", 5", 6", 7", 8", 8-1/4"
- SPECIAL INFO.:** 3/8" spring steel snap ring serves as internal stop. Rod eye threads into stage.
- IDENTIFICATION:** Cylinder model number and serial number stamped on cylinder body near base.

For all 10,000 Series Single Acting Cylinders manufactured from 7/74 through 8/76, kits include hard black wipers, vee sets and top and bottom bearings.

Part Number	Description	List Price
PISTON WEAR RINGS		
HY-10764-400	4-1/2" Nylon Piston Wear Ring	\$ 3.01
HY-10764-500	5-1/2" Nylon Piston Wear Ring	3.01
HY-10764-600	6-1/2" Nylon Piston Wear Ring	3.95
HY-10764-700	7-1/2" Nylon Piston Wear Ring	3.95
HY-10764-800	8-1/2" Nylon Piston Wear Ring	4.75
HY-10764-825	9" Nylon Piston Wear Ring	7.60
RETAINER RINGS		
HY-B9971-4.5	4" Retainer Ring	\$ 23.01
HY-B9971-5.5	5" Retainer Ring	23.36
HY-B9971-6.5	6" Retainer Ring	23.84
HY-B9971-7.5	7" Retainer Ring	23.84
HY-B9971-8.5	8" Retainer Ring	50.49
HY-B9971-900	8-1/4" Retainer Ring	105.83

Part Number	Description	List Price
VEE PACKING, NYLON TOP & BOTTOM BEARINGS AND WIPER KITS		
HY-11426-300	3" Pack Kit	\$ 34.22
HY-11426-400	4" Pack Kit	31.74
HY-11426-500	5" Pack Kit	41.79
HY-11426-600	6" Pack Kit	46.49
HY-11426-700	7" Pack Kit	59.74
HY-11426-800	8" Pack Kit	75.09
HY-11426-825	8-1/4" Pack Kit	147.84
MULTIPLE STAGE KITS		
HY-11426-48	4" - 8" Pack Kit	\$ 254.83



HYCO TELESCOPIC CYLINDERS

IMPORTANT NOTE:

WHEN ORDERING HYCO TELESCOPIC PARTS IT IS HELPFUL TO PROVIDE A MODEL NUMBER AND SERIAL NUMBER. THE SERIAL NUMBER IS STAMPED ONTO A METAL TAG APPLIED TO THE CYLINDER BODY. THE SERIAL NUMBER IS THE FIRST FOUR OR FIVE DIGITS OF THE NUMBER. THE LAST THREE OR FOUR DIGITS INDICATES THE DATE OF MANUFACTURE.

EXAMPLE 12345 10 93
 SERIAL # MONTH YEAR

C900 - C2000 SERIES SINGLE ACTING

MANUFACTURED BEFORE JULY 10, 1974

C9000 SERIES DOUBLE ACTING

ALL

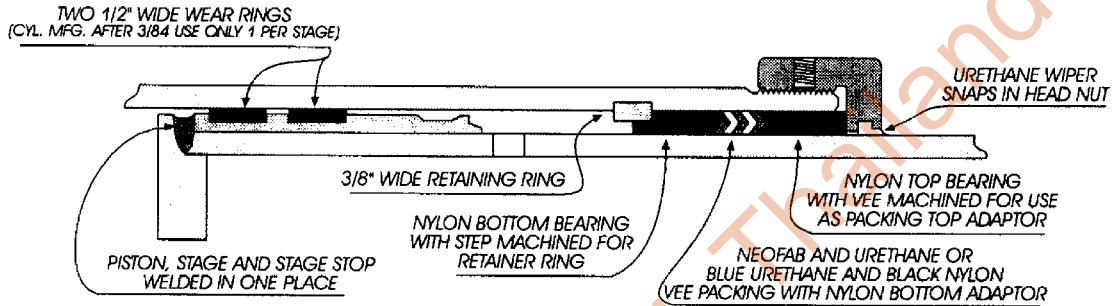

- PACKING: Vee packing with nylon top and bottom adaptors 1/4" c.s. on 4" through 8".
- WIPERS: Urethane snap-in type.
- BEARINGS: 2 bearings, one above the vee packing and the other "trapped" between the two spiral retainers. Original bearings were bronze. Currently many replacements are glass filled or mineral filled nylon.
- PISTON: Single acting cylinders have piston welded to stage. Piston bearings are bronze overlay on steel nylon. Double acting cylinders have steel piston which threads onto stage. Contains 2, 1/2" wide nylon wear rings and 2 cast iron piston rings in common groove.
- STAGE O.D.s: 3", 4", 5", 6", 7", 8", 8-1/4", 9", 9-3/4"
- SPECIAL INFO.: 2 spiral retaining rings with bearings "trapped" between them serving as internal stop.
- IDENTIFICATION: Cylinder model number and serial number stamped on metal tag applied to cylinder body.

For all C900 - C2000 Series single acting cylinders manufactured before 7/74 and all C9000 Series double acting telescopic, pack kits include only the wiper and vee packing. Nylon and bronze bearings are offered separately.

Part Number	Description	List Price
INDIVIDUAL STAGE VEE PACKING AND WIPER SETS		
HY-2VSW	2" Packing & Wiper	\$ 10.23
HY-3VSW	3" Packing & Wiper	10.45
HY-4VSW	4" Packing & Wiper	11.61
HY-5VSW	5" Packing & Wiper	15.79
HY-6VSW	6" Packing & Wiper	19.26
HY-7VSW	7" Packing & Wiper	22.50
HY-8.12VSW	8-1/8" Packing & Wiper	44.54
HY-8.25VSW	8-1/4" Packing & Wiper	57.93
HY-8VSW	8" Packing & Wiper	25.34
HY-9.12VSW	9-1/8" Packing & Wiper	83.71
HY-9.37VSW	9-3/8" Packing & Wiper	66.96
HY-9.75VSW	9-3/4" Packing & Wiper	94.92
HY-9VSW	9" Packing & Wiper	65.83

Part Number	Description	List Price
MULTIPLE STAGE VEE PACKING AND WIPER SETS		
HY-35	3" - 5" Pack Kit	\$ 38.50
HY-36	3" - 6" Pack Kit	58.52
HY-38	3" - 8" Pack Kit	108.28
HY-46	4" - 6" Pack Kit	48.06
HY-47	4" - 7" Pack Kit	71.47
HY-48	4" - 8" Pack Kit	97.82
HY-48-1/4	4" - 8-1/4" Pack Kit	131.72
HY-49	4" - 9" Pack Kit	166.27
HY-57	5" - 7" Pack Kit	59.83
HY-58	5" - 8" Pack Kit	86.20
HY-59-3/4	5" - 9-3/4" Pack Kit	215.02

HYCO TELESCOPIC CYLINDERS

C900 - C2000 SERIES SINGLE ACTING

AND

C9000 SERIES DOUBLE ACTING

MANUFACTURED BEFORE JULY10, 1974

ALL

Part Number	Description	List Price
NYLON BEARINGS		
HY-A18415N	9" Nylon Bearing	\$ 39.51
HY-A2225N	6" Nylon Bearing	8.89
HY-A2226N	5" Nylon Bearing	7.52
HY-A2227N	4" Nylon Bearing	7.14
HY-A2411N	7" Nylon Bearing	9.68
HY-A2447N	8" Nylon Bearing	11.72
HY-A2475N	3" Nylon Bearing	7.14
HY-A3438N	8-1/4" Nylon Bearing	22.20
NYLON BEARING KITS		
HY-NYB38	2 ea. 3" - 8" Nylon Bearings	\$ 104.21
HY-NYB46	2 ea. 4" - 6" Nylon Bearings	47.12
HY-NYB47	2 ea. 4" - 7" Nylon Bearings	66.49
HY-NYB48	2 ea. 4" - 8" Nylon Bearings	89.91
HY-NYB48-1/4	2 ea. 4" - 8-1/4" Nylon Bearings	110.87
HY-NYB49	2 ea. 4" - 9" Nylon Bearings	168.92
HY-NYB57	2 ea. 5" - 7" Nylon Bearings	52.17
HY-NYB58	2 ea. 5" - 8" Nylon Bearings	75.59
BRONZE BEARINGS		
HY-A18415B	9" Bronze Bearing	\$ 58.57
HY-A2225B	6" Bronze Bearing	24.58
HY-A2226B	5" Bronze Bearing	22.25
HY-A2227B	4" Bronze Bearing	19.76
HY-A2411B	7" Bronze Bearing	27.04
HY-A2447B	8" Bronze Bearing	35.20
HY-A2475B	3" Bronze Bearing	22.10
HY-A3438B	8-1/4" Bronze Bearing	46.45
HY-A8258	9-3/4" Bottom Bronze Bearing	201.35
HY-A8308	9-3/4" Top Bronze Bearing	197.40
SPIRAL RETAINERS		
HY-A17793	5" Spiral Retainer	\$ 7.50
HY-A17794	4" Spiral Retainer	7.34
HY-A18387	9" Spiral Retainer	46.05
HY-A2228	6" Spiral Retainer	5.82
HY-A2477	3" Spiral Retainer	3.08
HY-A3012	7" Spiral Retainer	7.69
HY-A3013	8" Spiral Retainer	9.55
HY-A4616	8-1/4" Spiral Retainer	39.47
HY-A8246	9-3/4" Spiral Retainer	80.24
SPIRAL RETAINER KITS		
HY-SR48	2 ea. 4" - 8" Spiral Retainers	\$ 75.27
HY-SR49	2 ea. 4" - 9" Spiral Retainers	167.37
HY-SR58	2 ea. 5" - 8" Spiral Retainers	60.36

Part Number	Description	List Price
PISTON RINGS Double Acting Only		
HY-A18025	8-1/2" O.D. Cast Iron Piston Ring	\$ 30.27
HY-A18026	7-1/2" O.D. Cast Iron Piston Ring	21.62
HY-A18027	6-1/2" O.D. Cast Iron Piston Ring	15.09
HY-A18028	5-1/2" O.D. Cast Iron Piston Ring	12.56
HY-A18029	4-1/2" O.D. Cast Iron Piston Ring	9.15
HY-A18385	9-3/4" O.D. Cast Iron Piston Ring	48.09
PISTON RING KITS Double Acting Only		
HY-PR48	2 ea. 4-1/2"-8-1/2" Piston Rings	\$ 149.92
HY-PR49	2 ea. 4-1/2"-9-3/4" Piston Rings	217.63
PISTON WEAR RINGS Double Acting Only		
HY-10764-400	4-1/2" O.D. Piston Wear Ring	\$ 3.01
HY-10764-500	5-1/2" O.D. Piston Wear Ring	3.01
HY-10764-600	6-1/2" O.D. Piston Wear Ring	3.95
HY-10764-700	7-1/2" O.D. Piston Wear Ring	3.95
HY-10764-800	8-1/2" O.D. Piston Wear Ring	4.75
HY-10764-900	9-3/4" O.D. Piston Wear Ring	8.12
NYLON PISTON WEAR RING KITS Double Acting Only		
HY-NPB48	2 ea. 4-1/2"-8-1/2" Piston Wear Rings	\$ 38.08
HY-NPB49	2 ea. 4-1/2"-9-3/4" Piston Wear Rings	54.35
HEADNUTS		
Getting the correct Hyco headnut can be a problem. If you are unsure, call our sales department. Headnuts are measured at the I.D. of the wiper.		
HY-A2527	3" Headnut	\$ 68.25
HY-A2217	4" Headnut	70.36
HY-A2216	5" Headnut	71.59
HY-A2215	6" Headnut	86.21
HY-A3535	7" Headnut	178.83
HY-A2406	7" Headnut	119.67
HY-A2442	8" Headnut	182.72
HY-A3534	8-1/4" Headnut	223.83
HY-A18411	9" Headnut	155.09



HYCO PISTON-ROD CYLINDERS

Kit Number	Cylinder Number	Code (Pg. x)	Rod X Bore Size	List Price
HY-A18881	C4979	I-V-12	2 X 4-1/2	\$ 35.04
HY-A22227	C6312	I-V-5	2 X 4	32.54
HY-A22228	C6404	I-N-4	2-1/2 X 3-1/2	11.88
HY-A22229	C6403	I-V-5	2-1/2 X 6	55.07
HY-A22230	C6443	I-V-5	2 X 5	41.46
HY-A22231	C6402	I-V-5	3 X 5	45.48
HY-A22286	C6304	I-U-5	3 X 5	44.22
HY-A22368	C5845	I-U-5	2-1/2 X 5	42.20
HY-A22891	C6591	I-U-5	3-1/2 X 4-1/2	42.20
HY-C2062K	C2062	I-V-9	2 X 6-1/2	52.98
HY-C2526K	C2526	I-V-7	2-1/2 X 5	50.63
HY-C2670K	C2670	I-V-5	2 X 3-1/4	40.96
HY-C2672K	C2672	I-V-5	2-1/2 X 5	60.07
HY-C2699K	C2699	I-V-5	2 X 4	46.28
HY-C3571K	C3571	I-V-9	1-1/2 X 3-1/2	44.09
HY-C3650K	C3650	I-V-5	3 X 6	45.76
HY-C3651K	C3651	I-V-5	3 X 7	67.37
HY-C4658K	C4658	I-V-5	3 X 7	53.27
HY-C4794K	C4794	I-V-5	3 X 7	69.25
HY-C4797K	C4797	I-V-9	3 X 7	120.89
HY-C6217K	C6217	I-V-9	2 X 6	82.18
HY-C6410K	C6410	I-U-5	2 X 4	33.33
HY-C6429K	C6429	I-V-5	3 X 7	73.85

HYDRO-AX

Kit Number	Code (Pg. x)	Rod X Bore Size	List Price
HA-2401-1046	P-V-12	2 X 3-1/2	\$ 42.73
HA-2401-1097	I-U-11	2 x 3-1/2	21.27
HA-2401-1100	I-U-11	1-1/4 X 3	18.24
HA-3002-1016	I-U-10	2 X 3-1/2	17.32
HA-3002-1031	I-U-10	1-1/2 X 3	14.84
HA-3002-1086	I-U-10	2-1/2 X 5-1/2	32.65
HA-3002-1092	P-U-10	1-1/4 X 2-1/2	12.92
HA-8711016	I-U-10	2 X 3-1/2	16.82
HA-8711031	I-U-10	1-1/2 X 3	14.10
HA-8711056	I-U-10	2-1/2 X 4-1/2	23.81
HA-8711086	I-U-10	2-1/2 X 5-1/2	32.40
HA-8711090	I-U-10	3 X 6	57.39
HA-8804019	I-U-11	2 X 3-1/2	28.69
HA-8804032	I-U-11	2-1/2 X 4	51.12
HA-8804048	I-U-13	1-1/2 X 3	24.12
HA-8804062	I-U-11	1-1/4 X 2-1/2	19.46
HA-8804076	I-U-13	2-1/2 X 4-1/2	42.60
HA-8804094	I-U-11	3 X 6	55.65
HA-8804105	I-U-13	2-1/2 X 5-1/2	54.91

HYDRO-AX

Kit Number	Code (Pg. x)	Rod X Bore Size	List Price
HA-8804125	I-U-11	4-1/2 X 8	\$ 123.98
HA-8804138	I-U-11	4 X 7	80.43
HA-8804178	I-U-13	2-1/2 X 5	33.03
HA-8804197	I-U-11	4 X 6	55.65
HA-8804213	I-U-11	4-1/2 X 8	118.72
HA-8804214	I-U-11	4 X 7	80.43
HA-8804232	I-U-11	4 X 6	70.49

HYSTER

Kit Number	Code (Pg. x)	Rod X Bore Size	List Price
HA-2401-1046	P-V-12	2 X 3-1/2	\$ 42.73
HA-2401-1097	I-U-11	2 x 3-1/2	21.27
HA-2401-1100	I-U-11	1-1/4 X 3	18.24
HA-3002-1016	I-U-10	2 X 3-1/2	17.32
HA-3002-1031	I-U-10	1-1/2 X 3	14.84
HA-3002-1086	I-U-10	2-1/2 X 5-1/2	32.65
HA-3002-1092	P-U-10	1-1/4 X 2-1/2	12.92
HA-8711016	I-U-10	2 X 3-1/2	16.82
HA-8711031	I-U-10	1-1/2 X 3	14.10
HA-8711056	I-U-10	2-1/2 X 4-1/2	23.81
HA-8711086	I-U-10	2-1/2 X 5-1/2	32.40
HA-8711090	I-U-10	3 X 6	57.39
HA-8804019	I-U-11	2 X 3-1/2	28.69
HA-8804032	I-U-11	2-1/2 X 4	51.12
HA-8804048	I-U-13	1-1/2 X 3	24.12
HA-8804062	I-U-11	1-1/4 X 2-1/2	19.46
HA-8804076	I-U-13	2-1/2 X 4-1/2	42.60
HA-8804094	I-U-11	3 X 6	55.65
HA-8804105	I-U-13	2-1/2 X 5-1/2	54.91
HA-8804125	I-U-11	4-1/2 X 8	\$ 123.98
HA-8804138	I-U-11	4 X 7	80.43
HA-8804178	I-U-13	2-1/2 X 5	33.03
HA-8804197	I-U-11	4 X 6	55.65
HA-8804213	I-U-11	4-1/2 X 8	118.72
HA-8804214	I-U-11	4 X 7	80.43
HA-8804232	I-U-11	4 X 6	70.49
HYS-250937	I-U-8	1-1/2 X 3.525	69.65
HYS-250943	I-U-1	3.70, 5.45 STAGES	128.16
HYS-280182	I-O-10	1 X 2-1/4	9.25
HYS-280537	I-U-4	2-1/8 X 2-1/2	31.82
HYS-281474	P-U-10	1-1/2 X 3-1/2	24.94
HYS-281815	I-U-10	1-3/4 X 3-1/2	12.77
HYS-281822	I-U-10	1-1/4 X 3	11.69
HYS-281855	I-U-10, 12	1-3/4 X 3-1/2	26.42
HYS-281859	I-U-10, 12	2-1/4 X 3-1/2	28.13

HYSTER

Kit Number	Code (Pg. x)	Rod X Bore Size	List Price
HYS-281864	I-U-10	1-3/4 X 3-1/2	\$ 12.87
HYS-314993	O-RING KIT		3.67
HYS-318005	I-U-1	2-3/4, 3-3/4 STAGES	41.95
HYS-321758	I-U-10	2-1/4 X 4-1/2	18.95
HYS-321909	I-U-5	3 X 4-3/4	69.62
HYS-323645	I-U-8	1-3/4 X 4	34.67
HYS-327393	I-U-4	2-1/8 X 2-1/2	23.28
HYS-328074	I-U-10	1-1/4 X 2-3/4	14.00
HYS-328121	P-U-10	1-1/4 X 3	27.31
HYS-328226	P-U-10	1-3/4 X 4-1/4	28.41
HYS-333742	P-U-10	2-1/8 X 3	40.79
HYS-334997	I-U-10	1-1/4 X 2-3/4	16.26

Kit Number	Code (Pg. x)	Rod X Bore Size	List Price
HYS-337281	I-U-4	1-3/8 X 2	\$ 22.85
HYS-339347	I-U-4	2 STAGES, 4 - 5"	96.56
HYS-340079	N-U-4	1-3/4 X 2-3/4	29.57
HYS-355695	P-U-10	1-3/8 X 3	24.32
HYS-355909	I-U-5	1-1/2 X 4	34.79
HYS-381762	I-U-10	2-7/8 X 4-1/2	38.36
HYS-383991	P-U-10	1-1/4 X 3	23.28
HYS-48628	I-U-4	3/4 X 1-5/8	11.68
HYS-629326	Hose Reel Kit		4.57
HYS-639456	I-U-4	3 X 3-1/2	37.04
HYS-643280	I-U-4	3 X 3-1/2	39.18

Replacement Kits For

HYUNDAI

Excavators					
APPLICATION	CODE	ROD	BORE	KIT #	List \$
MODEL 130LC					
ARM	P-UB-10	80 mm	115 mm	HYU-91E6-2712	245.92
BOOM	P-UB-10	75 mm	105 mm	HYU-91E6-2711	80.62
BUCKET	P-UB-10	70 mm	100 mm	HYU-91E6-2713	87.62
MODEL R200LC, R210LC					
ARM	P-UB-14	95 mm	140 mm	HYU-91E1-2707	284.42
BOOM	P-UB-14	85 mm	125 mm	HYU-91E1-2706	252.45
BUCKET	P-UB-14	80 mm	120 mm	HYU-91E1-2708	232.20
MODEL R280LC, R320LC-1					
ARM	P-UB-10	105 mm	150 mm	HYU-91E2-2708	251.58
BOOM	P-UB-10	95 mm	145 mm	HYU-91E2-2707	265.00
BUCKET	P-UB-10	95 mm	145 mm	HYU-91E2-2709	254.17
MODEL R420LC, R450LC					
ARM	P-UB-14	120 mm	185 mm	HYU-31E7-2712	380.94
BOOM	P-UB-14	110 mm	160 mm	HYU-31E7-2711	330.30
BUCKET	P-UB-14	110 mm	160 mm	HYU-31E7-2713	428.92

HYUNDAI

Kit Number	Code (Pg. x)	Rod X Bore Size	List Price
HYU-31E7-2711	P-UB-14	110 X 160 mm	\$ 330.30
HYU-31E7-2712	P-UB-14	120 X 185 mm	380.94
HYU-31E7-2713	P-UB-14	110 X 160 mm	428.92
HYU-31Y1-05260	P-UB-14	85 X 125	160.33
HYU-91E1-2706	P-UB-14	85 X 125 mm	252.45
HYU-91E1-2707	P-UB-14	95 X 140 mm	284.42
HYU-91E1-2708	P-UB-14	80 X 120 mm	232.20
HYU-91E2-2707	P-UB-10	95 X 145 mm	265.00

Kit Number	Code (Pg. x)	Rod X Bore Size	List Price
HYU-91E2-2708	P-UB-10	105 X 150 mm	\$ 251.58
HYU-91E2-2709	P-UB-10	95 X 145 mm	254.17
HYU-91E6-2711	P-UB-10	75 X 105 mm	80.62
HYU-91E6-2712	P-UB-10	80 X 115 mm	245.92
HYU-91E6-2713	P-UB-10	70 X 100 mm	87.62

INGERSOLL-RAND

Kit Number	Code (Pg. x)	Rod X Bore Size	List Price
IR-50428648	I-U-10	3 X 5	\$ 22.58
IR-50779636	P-U-10	3 X 6	175.96
IR-51318095	O-RING KIT		6.48
IR-51324887	I-SPB-1	53,63	127.08
IR-51779346	I-U-5	1-1/4 X 1-1/2	146.28
IR-52119906	VALVE KIT		10.01
IR-52163987	P-U-10	3 X 4	54.00
IR-58150798	I-U-5	1-1/2 X 3-1/2	26.30
IR-59484246	I-U-10	1-1/8 X 2-1/2	17.96
IR-6589792	I-U-10	1-1/2 X 3-1/4	16.82
IR-6661441	P-O-1	1-1/8 Shaft Kit	3.24
IR-6803329	I-U-10	1-1/4 X 2	16.62
IR-6803472	I-U-10	1 X 2	12.92
IR-6804605	I-U-10	1-1/2 X 3-1/4	28.69
IR-70035308	I-V-5	70 X 100 mm	203.37
IR-70035324	I-U-10	63 X 100 mm	46.68
IR-95295879	O-RING		24.17
IR-97114698	OIL SEAL		10.75
IR-97120679	PUMP KIT		32.28

INTERNATIONAL HARVESTER

Kit Number	Code (Pg. x)	Rod X Bore Size	List Price
IH1124732C94	P-U-10	1-1/2 X 3	\$ 49.81
IH1124738C91	P-U-10	1-1/2 X 4	28.09
IH1124745C91	P-U-10	2 X 4	43.01
IH1124749C91	P-U-10	2-3/4 X 4-1/2	43.47
IH1124749C93	P-U-10	2-3/4 X 4-1/2	38.98
IH1124749C94	P-UB-10	2-3/4 X 4-1/2	59.05
IH1124757C94	P-UB-10	2-3/4 X 5-1/2	185.08
IH1124774C93	P-U-10	3-1/2 X 7	201.75
IH1124867C91	P-U-10, 12	3-3/4, 5-3/4, 6-3/4 Stages	617.02
IH1126587C91	P-U-10	2 X 3-1/2	33.27
IH1126592C91	P-U-10	2-3/4 X 4-1/2	38.56
IH1126614C91	P-U-10	2-1/2 X 6-1/2	53.07
IH386693R92	P-OB-10	1-1/2 X 2-1/2	18.73
IH471270R95	P-U-10, 12	1-1/2 X 2-1/2	33.11
IH533625R93	P-U-10	2-1/2 X 4-1/2	34.51

INTERNATIONAL HARVESTER

Kit Number	Code (Pg. x)	Rod X Bore Size	List Price
IH533626R93	P-U-10	2-1/2 X 4	\$ 34.97
IH545299R92	P-U-10	2-1/4 X 3-1/2	33.47
IH545300R93	P-U-10	2-1/4 X 4-1/2	37.24
IH545829R93	P-U-10	2 X 3-1/2	32.89
IH545831R93	P-U-10	2-1/4 X 4	33.14
IH546214R93	P-U-10	2 X 3-1/2	24.01
IH609615C1	I-N-U	2-1/2 X 2-1/2	15.14
IH622825C91	Track Adjuster for a TD8		12.53
IH626199C1	P-U-10	1-1/2 X 3	18.74
IH626230C3	P-U-10	1-3/4 X 3-1/2	21.17
IH626230C6	P-UB-10	1-3/4 X 3-1/2	52.17
IH626232C2	P-U-10	2-1/4 X 3-1/2	23.92
IH626233C2	P-U-10	2-1/2 X 4	24.85
IH626234C3	P-U-10	1-3/4 X 4	21.84
IH63577C91	P-U-10	2-1/4 X 4	37.59
IH63581C91	P-U-10	2-1/4 X 3-1/2	36.76
IH636139C91	I-U-10	2-3/4 X 5	106.74
IH636144C91	P-U-10	2-1/2 X 5-1/2	48.77
IH636145C91	P-U-10	2-1/2 X 5-1/2	56.40
IH636146C91	P-U-10	3 X 5-1/2	83.52
IH636147C91	P-U-10	3 X 5-1/2	52.23
IH636149C91	P-U-10	2-1/2 X 6-1/2	102.89
IH636229C91	P-U-10	2-3/4 X 6-1/2	106.31
IH636230C91	P-U-10	3 X 7	74.83
IH63698C91	P-U-10	2 X 3	23.20
IH679325C91	P-U-10	2-1/4 X 4-1/2	38.72
IH679328C91	P-U-10	2-3/4 X 5	110.83
IH679330C91	P-U-10	2-3/4 X 6-1/2	66.98
IH679331C91	P-U-10	2-3/4 X 6-1/2	56.29
IH679332C91	P-U-10	3 X 7	126.38
IH-906000	TRACK ADJUSTER		13.30
IH-906001	TRACK ADJUSTER		13.38
IH-906004	TRACK ADJUSTER		26.97
IH927444C91	O-Rings		4.52
IH933310C91	P-U-10	4-1/2 X 9	152.58
IH933419C91	P-U-10	2 X 4	37.99
IH935799C91	P-U-10	1-1/2 X 4	34.79
IH943746C91	P-OB-10	1 X 3	15.62

Replacement Kits For

JCB

JCB

Backhoe Loaders							
APPLICATION	CYL #	SERIAL #	CODE	ROD	BORE	KIT #	List \$
MODEL 3CX							
BACKHOE BUCKET		-->M319999	I-U-15	50 mm	90 mm	JCB-991-00013	31.07
		M320000-UP	I-U-15	50 mm	90 mm	JCB-991-00096	70.99
BACKHOE BOOM & STICK		-->M319999	I-U-15	60 mm	100 mm	JCB-991-00012	34.62
		M320000-UP	I-U-15	60 mm	100 mm	JCB-991-00055	76.95
LOADER LIFT		-->M319999	I-U-15	50 mm	80 mm	JCB-991-00016	33.26
		M320000-UP	I-U-15	50 mm	80 mm	JCB-991-00061	70.99
LOADER TILT		-->M319999	I-U-15	40 mm	70 mm	JCB-991-00015	25.87
		M320000-UP	I-U-15	40 mm	70 mm	JCB-991-00025	33.26
STABILIZER - Heavy Duty		-->M319999	I-U-15	60 mm	100 mm	JCB-991-00012	34.62
		M320000-UP	I-U-15	60 mm	100 mm	JCB-991-00055	76.95
STABILIZER - Standard		-->M319999	I-U-15	40 mm	70 mm	JCB-991-00015	25.87
		M320000-UP	I-U-15	40 mm	70 mm	JCB-991-00025	33.26
STEERING-2WD		M290000-M300725	I-U-15	30 mm	60 mm	JCB-991-00017	34.75
		M300726-M337000	I-U-14	30 mm	60 mm	JCB-991-00021	28.80
		M337001-M356443	I-U-15	30 mm	70 mm	JCB-991-00036	26.21
STEERING-4WD		M290000-M297207	I-U-15	30 mm	60 mm	JCB-991-00017	34.75
		M297208-M319999	I-U-14	30 mm	60 mm	JCB-991-00020	17.76
		M320000-M337000	I-U-14	30 mm	60 mm	JCB-991-00021	28.80
STICK EXTENSION		-->M319999	I-U-15	40 mm	70 mm	JCB-991-00015	25.87
		M320000-UP	I-U-15	40 mm	70 mm	JCB-991-00025	33.26
SWING		-->M319999	I-U-15	60 mm	100 mm	JCB-991-00012	34.62
		M320000-UP	I-U-15	60 mm	100 mm	JCB-991-00055	76.95
SWING W/ Side Shift		-->M319999	N-N-15		110 mm	JCB-991-00018	18.48
MODEL 3CX SITEMASTER							
BACHOE BOOM		M320000-UP	I-U-15	60 mm	110 mm	JCB-991-00058	79.37
BACKHOE BUCKET		M320000-UP	I-U-15	50 mm	90 mm	JCB-991-00096	70.99
LOADER LIFT		M320000-UP	I-U-15	50 mm	80 mm	JCB-991-00061	70.99
LOADER TILT		M320000-UP	I-U-15	40 mm	70 mm	JCB-991-00025	33.26
STABILIZER - Heavy Duty		M320000-UP	I-U-15	60 mm	100 mm	JCB-991-00055	76.95
STABILIZER - Standard		M320000-UP	I-U-15	40 mm	70 mm	JCB-991-00025	33.26
STEERING-2WD		M300726-M337000	I-U-14	30 mm	60 mm	JCB-991-00021	28.80
		M337001-M356443	I-U-15	30 mm	70 mm	JCB-991-00036	26.21
STEERING-4WD		M290000-M297206	I-U-15	30 mm	60 mm	JCB-991-00017	34.75
		M297207-M319999	I-U-14	30 mm	60 mm	JCB-991-00020	17.76
		M320000-M337000	I-U-14	30 mm	60 mm	JCB-991-00021	28.80
STICK		M320000-UP	I-U-15	60 mm	100 mm	JCB-991-00055	76.95
STICK EXTENSION		M320000-UP	I-U-15	40 mm	70 mm	JCB-991-00025	33.26
SWING		M320000-UP	I-U-15	60 mm	100 mm	JCB-991-00055	76.95
MODEL 4CN, 4C TURBO							
BACKHOE BOOM		-->M319999	I-U-15	60 mm	110 mm	JCB-991-00014	33.26
		M320000-UP	I-U-15	60 mm	110 mm	JCB-991-00058	79.37
BACKHOE BUCKET		-->M319999	I-U-15	50 mm	90 mm	JCB-991-00013	31.07
		M320000-UP	I-U-15	50 mm	90 mm	JCB-991-00096	70.99
LOADER LIFT		-->M319999	I-U-15	50 mm	80 mm	JCB-991-00016	33.26
		M320000-UP	I-U-15	50 mm	80 mm	JCB-991-00061	70.99
LOADER TILT		-->M319999	I-U-15	40 mm	70 mm	JCB-991-00015	25.87
		M320000-UP	I-U-15	40 mm	70 mm	JCB-991-00025	33.26
STABILIZER		-->M319999	I-U-15	60 mm	100 mm	JCB-991-00012	34.62

Replacement Kits For

JCB

Backhoe Loaders

APPLICATION	CYL #	SERIAL #	CODE	ROD	BORE	KIT #	List \$
MODEL 4CN, 4C TURBO							
STABILIZER		M320000-UP	I-U-15	60 mm	100 mm	JCB-991-00055	76.95
STEERING-2WD		M290000-M300725	I-U-15	30 mm	60 mm	JCB-991-00017	34.75
		M300726-M337000	I-U-14	30 mm	60 mm	JCB-991-00021	28.80
STEERING-4WD		M290000-M297207	I-U-15	30 mm	60 mm	JCB-991-00017	34.75
		M297208-M319999	I-U-14	30 mm	60 mm	JCB-991-00020	17.76
		M320000-M337000	I-U-14	30 mm	60 mm	JCB-991-00021	28.80
		M337001-M356443	I-U-15	30 mm	70 mm	JCB-991-00036	26.21
STICK		-->M319999	I-U-15	60 mm	100 mm	JCB-991-00012	34.62
		M320000-UP	I-U-15	60 mm	100 mm	JCB-991-00055	76.95
STICK EXTENSION		-->M319999	I-U-15	40 mm	70 mm	JCB-991-00015	25.87
		M32000-UP	I-U-15	40 mm	70 mm	JCB-991-00025	33.26
SWING - Heavy Duty		-->M319999	I-U-15	60 mm	110 mm	JCB-991-00014	33.26
		M32000-UP	I-U-15	60 mm	110 mm	JCB-991-00058	79.37
SWING - Standard		-->M319999	I-U-15	60 mm	100 mm	JCB-991-00012	34.62
		M320000-UP	I-U-15	60 mm	100 mm	JCB-991-00055	76.95
MODEL 208S, 208S HF							
BOOM	556-60025	M751600-UP	I-U-10	40 mm	70 mm	JCB-991-00100	33.34
BUCKET 7' 3"	556-60026	M751600-UP	I-U-10	40 mm	70 mm	JCB-991-00100	33.34
BUCKET 8' 4"	556-60049	M751600-UP	I-U-10	40 mm	70 mm	JCB-991-00100	33.34
CLAMSHOVEL	551-60021	M751600-UP	I-U-10	25 mm	50 mm	JCB-991-00097	25.11
	980-38800	M751600-UP	I-U-10	25 mm	50 mm	JCB-991-00097	25.11
DIPPER	556-60027	M751600-UP	I-U-10	40 mm	70 mm	JCB-991-00100	33.34
HIGHTIP	997-07700	M751600-UP	I-U-15	1-3/8"	2"	JCB-903-10301	25.09
LIFT	553-60005	M751600-UP	I-U-10	30 mm	60 mm	JCB-991-00098	33.29
SHOVEL	553-60004	M751600-UP	I-U-10	30 mm	60 mm	JCB-991-00098	33.29
SIDETIP	997-0090	M751600-UP	I-U-15	1-1/2"	2-1/2"	JCB-997-00908	84.48
STABILIZER	553-60006	M751600-UP	I-U-10	30 mm	60 mm	JCB-991-00098	33.29
MODEL 210S, 210SU							
BUCKET	556-60000	M762248-M769999	I-U-10	40 mm	70 mm	JCB-991-00100	33.34
EXTENSION	553-60010	M762248-M769999	I-U-10	30 mm	60 mm	JCB-991-00098	33.29
	553-60022	M762248-M769999	I-U-10	30 mm	60 mm	JCB-991-00098	33.29
LIFT	556-60017	M762248-M769999	I-U-10	40 mm	70 mm	JCB-991-00100	33.34
LIFT LH	556-60023	M762248-M769999	I-U-10	40 mm	70 mm	JCB-991-00100	33.34
LIFT RH	556-60024	M762248-M769999	I-U-10	40 mm	70 mm	JCB-991-00100	33.34
SHOVEL	556-60084	M762248-M769999	I-U-10	40 mm	70 mm	JCB-991-00100	33.34
STABILIZER	556-60003	M762248-M769999	I-U-10	40 mm	70 mm	JCB-991-00100	33.34
	556-60093	M762248-M769999	I-U-10	40 mm	70 mm	JCB-991-00100	33.34
SWING	556-60010	M762248-M769999	I-U-10	40 mm	70 mm	JCB-991-00100	33.34
MODEL 214							
BOOM	561-39000	M400001-M430000	I-U-15	60 mm	110 mm	JCB-991-00131	79.37
	561-39100	M400001-M430000	I-U-15	60 mm	110 mm	JCB-991-00131	79.37
	561-60028	M400001-M430000	I-U-10	60 mm	110 mm	JCB-991-00110	46.01
	561-90011	M400001-M430000	I-U-10	60 mm	110 mm	JCB-991-00110	46.01
BUCKET	557-16000	M400001-M430000	I-U-15	50 mm	90 mm	JCB-991-00127	70.99
	557-16600	M400001-M430000	I-U-10	50 mm	90 mm	JCB-991-00103	47.36
	557-60006	M400001-M430000	I-U-15	50 mm	90 mm	JCB-991-00013	31.07
CLAMSHOVEL	556-31900	M400001-M430000	I-U-15	40 mm	70 mm	JCB-991-00025	33.26
	556-44000	M400001-M430000	I-U-10	40 mm	70 mm	JCB-991-00100	33.34

Replacement Kits For

JCB**JCB**

Backhoe Loaders							
APPLICATION	CYL #	SERIAL #	CODE	ROD	BORE	KIT #	List \$
MODEL 214							
CLAMSHOVEL DIPPER	556-60019	M400001-M430000	I-U-10	40 mm	70 mm	JCB-991-00100	33.34
	559-50000	M400001-M430000	I-U-15	60 mm	100 mm	JCB-991-00055	76.95
	559-50100	M400001-M430000	I-U-15	60 mm	100 mm	JCB-991-00055	76.95
	559-60009	M400001-M430000	I-U-10	60 mm	100 mm	JCB-991-00145	46.21
	559-60019	M400001-M430000	I-U-10	60 mm	100 mm	JCB-991-00145	46.21
EXTENSION	556-31000	M400001-M430000	I-U-15	40 mm	70 mm	JCB-991-00025	33.26
	556-44500	M400001-M430000	I-U-10	40 mm	70 mm	JCB-991-00100	33.34
	556-45400	M400001-M430000	I-U-15	40 mm	70 mm	JCB-991-00025	33.26
	556-60057	M400001-M430000	I-U-10	40 mm	70 mm	JCB-991-00100	33.34
JAW BUCKET LIFT	560-34300	M400001-M430000	I-SP-13	2"	4"	JCB-991-00003	33.17
	576-22100	M400001-M430000	I-U-15	50 mm	80 mm	JCB-991-00123	47.12
	576-60000	M400001-M430000	I-U-10	50 mm	80 mm	JCB-991-00102	44.88
SHOVEL	556-28900	M400001-M430000	I-U-15	40 mm	70 mm	JCB-991-00025	33.26
	556-44700	M400001-M430000	I-U-10	40 mm	70 mm	JCB-991-00095	33.34
STABILIZER	556-43700	M400001-M430000	I-U-10	40 mm	70 mm	JCB-991-00100	33.34
	559-53600	M400001-M430000	I-U-15	60 mm	100 mm	JCB-991-00055	76.95
	559-53700	M400001-M430000	I-U-15	60 mm	100 mm	JCB-991-00055	76.95
	559-60004	M400001-M430000	I-U-10	60 mm	100 mm	JCB-991-00145	46.21
STEERING	559-60005	M400001-M430000	I-U-10	60 mm	100 mm	JCB-991-00145	46.21
	556-33800	M400001-M430000	I-U-10	30 mm	70 mm	JCB-991-00099	35.27
	556-34000	M400001-M430000	I-U-10	30 mm	70 mm	JCB-991-00099	35.27
	556-46400	M400001-M430000	I-U-10	30 mm	70 mm	JCB-991-00099	35.27
	556-46500	M400001-M430000	I-U-10	30 mm	70 mm	JCB-991-00099	35.27
SWING	559-53400	M400001-M430000	I-U-15	60 mm	100 mm	JCB-991-00055	76.95
	559-53500	M400001-M430000	I-U-15	60 mm	100 mm	JCB-991-00055	76.95
MODEL 214E							
BOOM	561-60028	M430001-UP	I-U-10	60 mm	110 mm	JCB-991-00110	46.01
BUCKET	557-60006	M430001-UP	I-U-10	50 mm	90 mm	JCB-991-00103	47.36
DIPPER	559-60019	M430001-UP	I-U-10	60 mm	100 mm	JCB-991-00145	46.21
EXTENSION	556-60057	M430001-UP	I-U-10	40 mm	70 mm	JCB-991-00100	33.34
LIFT	576-60000	M430001-UP	I-U-10	50 mm	80 mm	JCB-991-00102	44.88
SHOVEL	556-44700	M430001-UP	I-U-10	40 mm	70 mm	JCB-991-00100	33.34
STABILIZER LH	559-60004	M430001-UP	I-U-10	60 mm	100 mm	JCB-991-00145	46.21
STABILIZER RH	559-60005	M430001-UP	I-U-10	60 mm	100 mm	JCB-991-00145	46.21
STEERING	556-46400	M430001-UP	I-U-10	30 mm	70 mm	JCB-991-00099	35.27
	556-46500	M430001-UP	I-U-10	30 mm	70 mm	JCB-991-00099	35.27
SWING	559-53400	M430001-UP	I-U-15	60 mm	100 mm	JCB-991-00055	76.95
	559-53500	M430001-UP	I-U-15	60 mm	100 mm	JCB-991-00055	76.95
MODEL 214SM-4							
BOOM LIFT	563-60028	M460001-UP	I-U-10	65 mm	120 mm	JCB-991-00115	64.42
	563-60029	M460001-UP	I-U-10	65 mm	120 mm	JCB-991-00115	64.42
BUCKET	557-60006	M460001-UP	I-U-10	50 mm	90 mm	JCB-991-00103	47.36
	557-60016	M460001-UP	I-U-10	50 mm	90 mm	JCB-991-00103	47.36
	557-60030	M460001-UP	I-U-10	60 mm	90 mm	JCB-991-00147	59.66
CLAMSHOVEL DIPPER LIFT	556-60077	M460001-UP	I-U-10	40 mm	70 mm	JCB-991-00100	33.34
	561-60060	M460001-UP	I-U-10	60 mm	110 mm	JCB-991-00148	65.51
	561-60061	M460001-UP	I-U-10	60 mm	110 mm	JCB-991-00148	65.51
	561-60071	M460001-UP	I-U-10	60 mm	110 mm	JCB-991-00148	65.51

Replacement Kits For

JCB

Backhoe Loaders

APPLICATION	CYL #	SERIAL #	CODE	ROD	BORE	KIT #	List \$
MODEL 214SM-4							
EXTENSION	556-60057	M460001-UP	I-U-10	40 mm	70 mm	JCB-991-00100	33.34
JAW BUCKET	560-34300	M460001-UP	I-SP-13	2"	4"	JCB-991-00003	33.17
LIFT	576-60000	M460001-UP	I-U-10	50 mm	80 mm	JCB-991-00102	44.88
SHOVEL	556-44700	M460001-UP	I-U-10	40 mm	70 mm	JCB-991-00100	33.34
STABILIZER	559-60063	M460001-UP	I-U-10	60 mm	100 mm	JCB-991-00145	46.21
	559-60069	M460001-UP	I-U-10	60 mm	100 mm	JCB-991-00152	44.33
STEERING	573-20001	M460001-UP	I-U-10	45 mm	75 mm	JCB-991-00156	56.62
SWING	559-60069	M460001-UP	I-U-10	60 mm	100 mm	JCB-991-00152	44.33
MODEL 215-4 CENTERMONUNT SERIES 3							
BOOM	556-60004	M460001-UP	I-U-10	75 mm	140 mm	JCB-991-00144	103.69
BUCKET	559-60024	M460001-UP	I-U-10	60 mm	100 mm	JCB-991-00145	46.21
	559-60074	M460001-UP	I-U-10	60 mm	100 mm	JCB-991-00145	46.21
CLAMSHOVEL	556-60077	M460001-UP	I-U-10	40 mm	70 mm	JCB-991-00100	33.34
DIPPER	561-60048	M460001-UP	I-U-10	65 mm	110 mm	JCB-991-00146	54.66
	561-60085	M460001-UP	I-U-10	65 mm	110 mm	JCB-991-00146	54.66
EXTENSION	556-60057	M460001-UP	I-U-10	40 mm	70 mm	JCB-991-00100	33.34
JAW BUCKET	560-34300	M460001-UP	I-SP-13	2"	4"	JCB-991-00003	33.17
LIFT	576-60000	M460001-UP	I-U-10	50 mm	80 mm	JCB-991-00102	44.88
SHOVEL	556-44700	M460001-UP	I-U-10	40 mm	70 mm	JCB-991-00100	33.34
SHOVEL C/W Reset Bracket	556-60022	M460001-UP	I-U-10	40 mm	70 mm	JCB-991-00100	33.34
STABILIZER	559-60063	M460001-UP	I-U-10	60 mm	100 mm	JCB-991-00145	46.21
STEERING	573-10001	M460001-UP	I-U-10	45 mm	75 mm	JCB-991-00156	56.62
SWING	559-60069	M460001-UP	I-U-10	60 mm	100 mm	JCB-991-00152	44.33
MODEL 215S							
BOOM	563-22600	M400001-M430000	I-U-15	65 mm	120 mm	JCB-991-00135	60.26
	563-60007	M400001-M430000	I-U-10	65 mm	120 mm	JCB-991-00115	64.42
	565-60004	M400001-M430000	I-U-10	70 mm	130 mm	JCB-991-00120	79.06
BUCKET	557-16000	M400001-M430000	I-U-15	50 mm	90 mm	JCB-991-00127	70.99
	557-16600	M400001-M430000	I-U-10	50 mm	90 mm	JCB-991-00103	47.36
CLAMSHOVEL	553-13800	M400001-M430000	I-U-15	40 mm	70 mm	JCB-991-00122	33.69
	556-44000	M400001-M430000	I-U-10	40 mm	70 mm	JCB-991-00095	33.34
	556-60019	M400001-M430000	I-U-10	40 mm	70 mm	JCB-991-00095	33.34
DIPPER	556-60051	M400001-M430000	I-U-10	40 mm	70 mm	JCB-991-00095	33.34
	559-50200	M400001-M430000	I-U-15	60 mm	100 mm	JCB-991-00130	76.95
	559-60013	M400001-M430000	I-U-10	60 mm	100 mm	JCB-991-00145	46.21
	556-31000	M400001-M430000	I-U-15	40 mm	70 mm	JCB-991-00122	33.69
EXTENSION	556-44500	M400001-M430000	I-U-10	40 mm	70 mm	JCB-991-00095	33.34
	556-45400	M400001-M430000	I-U-15	40 mm	70 mm	JCB-991-00122	33.69
	560-34300	M400001-M430000	I-SP-13	2"	4"	JCB-991-00003	33.17
JAW BUCKET	560-34300	M400001-M430000	I-SP-13	2"	4"	JCB-991-00003	33.17
LIFT	557-13100	M400001-M430000	I-U-15	50 mm	90 mm	JCB-991-00127	70.99
	557-16100	M400001-M430000	I-U-15	50 mm	90 mm	JCB-991-00127	70.99
	557-60000	M400001-M430000	I-U-10	50 mm	90 mm	JCB-991-00103	47.36
	557-60004	M400001-M430000	I-U-10	50 mm	90 mm	JCB-991-00103	47.36
SHOVEL	556-28900	M400001-M430000	I-U-15	40 mm	70 mm	JCB-991-00122	33.69
	556-44700	M400001-M430000	I-U-10	40 mm	70 mm	JCB-991-00095	33.34
	556-60022	M400001-M430000	I-U-10	40 mm	70 mm	JCB-991-00095	33.34
STABILIZER	559-53600	M400001-M430000	I-U-15	60 mm	100 mm	JCB-991-00130	76.95
	559-53700	M400001-M430000	I-U-15	60 mm	100 mm	JCB-991-00130	76.95

Replacement Kits For

JCB**JCB**

Backhoe Loaders							
APPLICATION	CYL #	SERIAL #	CODE	ROD	BORE	KIT #	List \$
MODEL 215S							
STABILIZER	559-60004	M400001-M430000	I-U-10	60 mm	100 mm	JCB-991-00145	46.21
	559-60005	M400001-M430000	I-U-10	60 mm	100 mm	JCB-991-00145	46.21
STEERING LH - Front	553-09600	M400001-M430000	I-U-10	30 mm	60 mm	JCB-991-00098	33.29
	553-13400	M400001-M430000	I-U-10	30 mm	60 mm	JCB-991-00098	33.29
STEERING LH - Rear	553-09800	M400001-M430000	I-U-10	30 mm	60 mm	JCB-991-00098	33.29
	553-13800	M400001-M430000	I-U-10	30 mm	60 mm	JCB-991-00098	33.29
	553-14100	M400001-M430000	I-U-10	30 mm	60 mm	JCB-991-00098	33.29
STEERING RH - Front	553-09700	M400001-M430000	I-U-10	30 mm	60 mm	JCB-991-00098	33.29
	553-13600	M400001-M430000	I-U-10	30 mm	60 mm	JCB-991-00098	33.29
STEERING RH - Rear	553-09900	M400001-M430000	I-U-10	30 mm	60 mm	JCB-991-00098	33.29
	553-13800	M400001-M430000	I-U-10	30 mm	60 mm	JCB-991-00098	33.29
	553-14300	M400001-M430000	I-U-10	30 mm	60 mm	JCB-991-00098	33.29
SWING	559-52800	M400001-M430000	I-U-15	60 mm	100 mm	JCB-991-00130	76.95
	559-52900	M400001-M430000	I-U-15	60 mm	100 mm	JCB-991-00130	76.95
	559-53400	M400001-M430000	I-U-15	60 mm	100 mm	JCB-991-00130	76.95
	559-53500	M400001-M430000	I-U-15	60 mm	100 mm	JCB-991-00130	76.95
MODEL 1400, 1400B							
BOOM	561-31200	M337001-M399999	I-U-15	60 mm	110 mm	JCB-991-00131	79.37
	561-39000	M337001-M399999	I-U-15	60 mm	110 mm	JCB-991-00131	79.37
	561-60011	M337001-M399999	I-U-15	60 mm	110 mm	JCB-991-00131	79.37
CLAMSHOVEL	556-23700	TO M435696	I-U-15	40 mm	70 mm	JCB-991-00122	33.69
	556-31900	M337001-M399999	I-U-15	40 mm	70 mm	JCB-991-00122	33.69
DIPPER	557-12900	M337001-M399999	I-U-15	50 mm	90 mm	JCB-991-00127	70.99
	557-16600	M337001-M399999	I-U-15	50 mm	90 mm	JCB-991-00127	70.99
	559-44000	M337001-M399999	I-U-15	60 mm	100 mm	JCB-991-00130	76.95
	559-50000	M337001-M399999	I-U-15	60 mm	100 mm	JCB-991-00130	76.95
EXTENSION	556-23800	M337001-M399999	I-U-15	40 mm	70 mm	JCB-991-00122	33.69
	556-31000	M337001-M399999	I-U-15	40 mm	70 mm	JCB-991-00122	33.69
JAW BUCKET	560-34300	M337001-M399999	I-SP-13	2"	4"	JCB-991-00003	33.17
	560-34300	M337001-M399999	I-SP-13	2"	4"	JCB-991-00003	33.17
LIFT	576-14100	M337001-M399999	I-U-15	50 mm	80 mm	JCB-991-00123	47.12
SHOVEL	556-23900	M337001-M399999	I-U-15	40 mm	70 mm	JCB-991-00122	33.69
STABILIZER	556-23600	M337001-M399999	I-U-15	40 mm	70 mm	JCB-991-00122	33.69
STABILIZER LH	559-36300	M337001-M399999	I-U-15	60 mm	100 mm	JCB-991-00130	76.95
	559-53600	M337001-M399999	I-U-15	60 mm	100 mm	JCB-991-00130	76.95
	559-60004	M337001-M399999	I-U-15	60 mm	100 mm	JCB-991-00130	76.95
STABILIZER RH	559-36400	M337001-M399999	I-U-15	60 mm	100 mm	JCB-991-00130	76.95
	559-53700	M337001-M399999	I-U-15	60 mm	100 mm	JCB-991-00130	76.95
	559-60005	M337001-M399999	I-U-15	60 mm	100 mm	JCB-991-00130	76.95
STEERING	556-27600	M337001-M399999	I-U-15	30 mm	70 mm	JCB-991-00036	26.21
	556-28700	M337001-M399999	I-U-15	30 mm	70 mm	JCB-991-00036	26.21
	556-46400	M337001-M399999	I-U-10	30 mm	70 mm	JCB-991-00099	35.27
	556-46500	M337001-M399999	I-U-10	30 mm	70 mm	JCB-991-00099	35.27
SWING LH	559-53400	M337001-M399999	I-U-15	60 mm	100 mm	JCB-991-00130	76.95
SWING RH	559-53500	M337001-M399999	I-U-15	60 mm	100 mm	JCB-991-00130	76.95
MODEL 1550, 1550B							
BOOM	563-15500	M337001-M399999	I-U-15	65 mm	120 mm	JCB-991-00135	60.26
BUCKET	557-12900	M337001-M399999	I-U-15	50 mm	90 mm	JCB-991-00127	70.99

Replacement Kits For

JCB

Backhoe Loaders

APPLICATION	CYL #	SERIAL #	CODE	ROD	BORE	KIT #	List \$	
MODEL 1550, 1550B								
BUCKET	557-16000	M337001-M399999	I-U-15	50 mm	90 mm	JCB-991-00127	70.99	
	557-16600	M337001-M399999	I-U-15	50 mm	90 mm	JCB-991-00127	70.99	
CLAMSHOVEL	556-23700	M337001-M399999	I-U-15	40 mm	70 mm	JCB-991-00122	33.69	
	556-31900	M337001-M399999	I-U-15	40 mm	70 mm	JCB-991-00122	33.69	
	556-44000	M337001-M399999	I-U-15	40 mm	70 mm	JCB-991-00122	33.69	
DIPPER	559-43200	M337001-M399999	I-U-15	60 mm	100 mm	JCB-991-00130	76.95	
	559-50200	M337001-M399999	I-U-15	60 mm	100 mm	JCB-991-00130	76.95	
EXTENSION - Long Type	556-23800	M337001-M399999	I-U-15	40 mm	70 mm	JCB-991-00122	33.69	
	556-31000	M337001-M399999	I-U-15	40 mm	70 mm	JCB-991-00122	33.69	
	556-44500	M337001-M399999	I-U-15	40 mm	70 mm	JCB-991-00122	33.69	
JAW BUCKET	560-34300	M337001-M399999	I-SP-13	2"	4"	JCB-991-00003	33.17	
LIFT	576-14100	M337001-M399999	I-U-15	50 mm	80 mm	JCB-991-00123	47.12	
SHOVEL	556-23900	M337001-M399999	I-U-15	40 mm	70 mm	JCB-991-00122	33.69	
STABILIZER	5568-36400	M337001-M399999	I-U-15	60 mm	100 mm	JCB-991-00130	76.95	
	559-53700	M337001-M399999	I-U-15	60 mm	100 mm	JCB-991-00130	76.95	
	559-60005	M337001-M399999	I-U-15	60 mm	100 mm	JCB-991-00130	76.95	
STEERING	556-27600	M337001-M399999	I-U-15	30 mm	70 mm	JCB-991-00036	26.21	
	556-28700	M337001-M399999	I-U-15	30 mm	70 mm	JCB-991-00036	26.21	
	556-33800	M337001-M399999	I-U-10	30 mm	70 mm	JCB-991-00099	35.27	
	556-33800	M337001-M399999	I-U-15	30 mm	70 mm	JCB-991-00036	26.21	
	556-34000	M337001-M399999	I-U-15	30 mm	70 mm	JCB-991-00036	26.21	
	556-34000	M337001-M399999	I-U-10	30 mm	70 mm	JCB-991-00099	35.27	
	556-46400	M337001-M399999	I-U-10	30 mm	70 mm	JCB-991-00099	35.27	
	556-46500	M337001-M399999	I-U-10	30 mm	70 mm	JCB-991-00099	35.27	
	SWING	559-53400	M337001-M399999	I-U-15	60 mm	100 mm	JCB-991-00130	76.95
MODEL 1700B								
BUCKET	557-12900	M337001-M399999	I-U-15	50 mm	90 mm	JCB-991-00127	70.99	
	557-16000	M337001-M399999	I-U-15	50 mm	90 mm	JCB-991-00127	70.99	
	557-16600	M337001-M399999	I-U-15	50 mm	90 mm	JCB-991-00127	70.99	
	559-36100	M337001-M399999	I-U-15	60 mm	100 mm	JCB-991-00130	76.95	
CLAMSHOVEL	556-23700	TO M345696	I-U-15	40 mm	70 mm	JCB-991-00122	33.69	
	556-44000	M337001-M399999	I-U-15	40 mm	70 mm	JCB-991-00122	33.69	
EXTENSION	556-23800	M337001-M399999	I-U-15	40 mm	70 mm	JCB-991-00122	33.69	
	556-31000	M337001-M399999	I-U-15	40 mm	70 mm	JCB-991-00122	33.69	
	556-44500	M337001-M399999	I-U-15	40 mm	70 mm	JCB-991-00122	33.69	
JAW BUCKET	560-34300	M337001-M399999	I-SP-13	2"	4"	JCB-991-00003	33.17	
LIFT	576-14100	M337001-M399999	I-U-15	50 mm	80 mm	JCB-991-00123	47.12	
SHOVEL	576-14300	M337001-M399999	I-U-15	50 mm	80 mm	JCB-991-00123	47.12	
STABILIZER LH	576-20200	M337001-M399999	I-U-15	50 mm	80 mm	JCB-991-00123	47.12	
	559-36300	M337001-M399999	I-U-15	60 mm	100 mm	JCB-991-00130	76.95	
	559-53600	M337001-M399999	I-U-15	60 mm	100 mm	JCB-991-00130	76.95	
STABILIZER RH	559-60004	M337001-M399999	I-U-15	60 mm	100 mm	JCB-991-00130	76.95	
	559-36400	M337001-M399999	I-U-15	60 mm	100 mm	JCB-991-00130	76.95	
	559-53700	M337001-M399999	I-U-15	60 mm	100 mm	JCB-991-00130	76.95	
STEERING	559-60005	M337001-M399999	I-U-15	60 mm	100 mm	JCB-991-00130	76.95	
	556-27600	M337001-M399999	I-U-15	30 mm	70 mm	JCB-991-00036	26.21	
	556-428700	M337001-M399999	I-U-15	30 mm	70 mm	JCB-991-00036	26.21	
	556-46400	M337001-M399999	I-U-10	30 mm	70 mm	JCB-991-00099	35.27	

Replacement Kits For

JCB**JCB**

Backhoe Loaders							
APPLICATION	CYL #	SERIAL #	CODE	ROD	BORE	KIT #	List \$
MODEL 1700B							
STEERING	556-46500	M337001-M399999	I-U-10	30 mm	70 mm	JCB-991-00099	35.27
SWING LH	559-53400	M337001-M399999	I-U-15	60 mm	100 mm	JCB-991-00130	76.95
SWING RH	559-53500	M337001-M399999	I-U-15	60 mm	100 mm	JCB-991-00130	76.95
MODEL SITEMASTER							
BACKHOE BOOM	561-31200	M337001-M399999	I-U-15	60 mm	110 mm	JCB-991-00131	79.37
	561-60011	M337001-M399999	I-U-15	60 mm	110 mm	JCB-991-00131	79.37
BACKHOE BUCKET	557-12900	M337001-M399999	I-U-15	50 mm	90 mm	JCB-991-00127	70.99
	557-16000	M337001-M399999	I-U-15	50 mm	90 mm	JCB-991-00127	70.99
	557-16600	M337001-M399999	I-U-15	50 mm	90 mm	JCB-991-00127	70.99
CLAMSHOVEL	556-23700	M337001-M399999	I-U-15	40 mm	70 mm	JCB-991-00122	33.69
	556-31900	M337001-M399999	I-U-15	40 mm	70 mm	JCB-991-00122	33.69
	556-44000	M337001-M399999	I-U-15	40 mm	70 mm	JCB-991-00122	33.69
DIPPER	559-44000	M337001-M399999	I-U-15	60 mm	100 mm	JCB-991-00130	76.95
	559-50000	M337001-M399999	I-U-15	60 mm	100 mm	JCB-991-00130	76.95
	559-50000	M337001-M399999	I-U-15	60 mm	100 mm	JCB-991-00130	76.95
EXTENSION	556-23800	M337001-M399999	I-U-15	40 mm	70 mm	JCB-991-00122	33.69
	556-31000	M337001-M399999	I-U-15	40 mm	70 mm	JCB-991-00122	33.69
	556-44500	M337001-M399999	I-U-15	40 mm	70 mm	JCB-991-00122	33.69
JAW BUCKET	560-34300	M337001-M399999	I-SP-13	2"	4"	JCB-991-00003	33.17
LIFT	576-14100	M337001-M399999	I-U-15	50 mm	80 mm	JCB-991-00123	47.12
LOADER BOOM	561-39000	M337001-M399999	I-U-15	60 mm	110 mm	JCB-991-00131	79.37
SHOVEL	556-23900	M337001-M399999	I-U-15	40 mm	70 mm	JCB-991-00122	33.69
STABILIZER	559-36400	M337001-M399999	I-U-15	60 mm	100 mm	JCB-991-00130	76.95
STEERING	556-27600	M337001-M399999	I-U-15	30 mm	70 mm	JCB-991-00036	26.21
	556-28700	M337001-M399999	I-U-15	30 mm	70 mm	JCB-991-00036	26.21
	556-33800	M337001-M399999	I-U-15	30 mm	70 mm	JCB-991-00036	26.21
	556-34000	M337001-M399999	I-U-15	30 mm	70 mm	JCB-991-00036	26.21
	556-46400	M337001-M399999	I-U-10	30 mm	70 mm	JCB-991-00099	35.27
	556-46500	M337001-M399999	I-U-10	30 mm	70 mm	JCB-991-00099	35.27
SWING	559-53400	M337001-M399999	I-U-15	60 mm	100 mm	JCB-991-00130	76.95
Loadall							
APPLICATION	CYL #	SERIAL #	CODE	ROD	BORE	KIT #	List \$
MODEL 505-19 F.M							
BOX TIPPER, STRIMECH	983-00130	M561011-M579360	I-U-15	50 mm	100 mm	JCB-983-00154	49.76
CARRIAGE - Sideshift	547-42101	M561011-M579360	I-U-4	7/8"	2"	JCB-547-42102	12.83
CLAMSHOVEL	556-44000	M561011-M579360	I-U-15	40 mm	70 mm	JCB-991-00025	33.26
	556-60019	M561011-M579360	I-U-10	40 mm	70 mm	JCB-991-00095	33.34
DISPLACEMENT	561-24200	M569247	I-U-15	50 mm	110 mm	JCB-991-00126	36.90
	561-60006	M561011-M579360	I-U-15	50 mm	110 mm	JCB-991-00126	36.90
	561-60019	M561011-M579360	I-U-10	50 mm	110 mm	JCB-991-00109	48.03
EXTENSION	553-13800	M561011-M579360	I-U-15	50 mm	70 mm	JCB-556-24900K	64.94
EXTENSION - Metric	556-60062	M561011-M579360	I-U-10	50 mm	70 mm	JCB-991-00105	47.33
LIFT	561-23600	M567495	I-U-15	60 mm	110 mm	JCB-991-00131	79.37
	561-42800	M569262	I-U-15	60 mm	110 mm	JCB-991-00131	79.37
	561-60005	M561011-M579360	I-U-15	60 mm	110 mm	JCB-991-00131	79.37
	561-60017	M561011-M579360	I-U-10	60 mm	110 mm	JCB-991-00110	46.01
LIFT - Float	561-60039	M561011-M579360	I-U-10	60 mm	110 mm	JCB-991-00110	46.01
LOG GRAB	545-45300	M561011-M579360	I-U-10	1-1/2"	2-3/8"	JCB-545-45307	28.29

Replacement Kits For

JCB

Loadall							
APPLICATION	CYL #	SERIAL #	CODE	ROD	BORE	KIT #	List \$
MODEL 505-19 F.M							
MANURE FORK	980-35601	M561011-M579360	I-U-10	1-1/2"	3"	JCB-980-35603	39.54
STEERING - Front	551-06200	M561011-M579360	I-U-10	25 mm	50 mm	JCB-993-46200K	30.93
STEERING - Front & Rear	551-06400	M561011-M579360	I-U-10	25 mm	50 mm	JCB-991-00071	25.74
	551-08500	M568555	I-U-10	25 mm	50 mm	JCB-991-00054	33.67
	551-10100	M561011-M579360	I-U-10	25 mm	50 mm	JCB-991-00097	25.11
STEERING - Front, JCB Option	993-46200	M561011-M579360	I-U-10	25 mm	50 mm	JCB-993-46200K	30.93
STEERING - Rear	551-06300	M561011-M579360	I-U-10	25 mm	50 mm	JCB-993-46200K	30.93
STEERING - Rear, JCB Option	993-46400	M561011-M579360	I-U-10	25 mm	50 mm	JCB-993-46200K	30.93
TILT	553-02000	M561011-M579360	I-U-14	30 mm	60 mm	JCB-991-00021	28.80
	553-04300	M561011-M579360	I-U-14	30 mm	60 mm	JCB-991-00021	28.80
	561-23900	M561307	I-U-15	50 mm	110 mm	JCB-991-00126	36.90
	561-33500	M569262	I-U-15	50 mm	110 mm	JCB-991-00126	36.90
	561-60009	M561011-M579360	I-U-15	50 mm	110 mm	JCB-991-00126	36.90
	561-60020	M561011-M579360	I-U-10	50 mm	110 mm	JCB-991-00109	48.03
TILT - Boom Float	561-60038	M561011-M579360	I-U-10	50 mm	110 mm	JCB-991-00109	48.03
TOW HITCH	556-31100	M561011-M579360	I-U-10	30 mm	70 mm	JCB-991-00069	20.18
	556-42200	M568560	I-U-10	30 mm	70 mm	JCB-991-00099	35.27
	556-46700	M561011-M579360	I-U-10	30 mm	70 mm	JCB-991-00099	35.27
MODEL 505-22, 505-22 SWAY							
BOX TIPPER, STRIMECH	983-00130	M561011-M579360	I-U-15	50 mm	100 mm	JCB-983-00154	49.76
CARRIAGE - Sideshift	547-42101	M561011-M579360	I-U-4	7/8"	2"	JCB-547-42102	12.83
	993-34500	M561011-M579360	I-U-4	1"	2-1/2"	JCB-993-34509	13.87
CLAMSHOVEL	556-44000	M561011-M579360	I-U-15	40 mm	70 mm	JCB-991-00025	33.26
	556-60019	M561011-M579360	I-U-10	40 mm	70 mm	JCB-991-00095	33.34
DISPLACEMENT	561-32400	M569237	I-U-15	50 mm	110 mm	JCB-991-00126	36.90
	561-60008	M561011-M579360	I-U-15	50 mm	110 mm	JCB-991-00126	36.90
	561-60025	M561011-M579360	I-U-10	50 mm	110 mm	JCB-991-00109	48.03
EXTENSION	556-32700	M561011-M579360	I-U-15	50 mm	70 mm	JCB-556-24900K	64.94
	556-60050	M561011-M579360	I-U-10	50 mm	70 mm	JCB-991-00105	47.33
LIFT	561-24500	M567495	I-U-15	60 mm	110 mm	JCB-991-00131	79.37
	561-42700	M569149	I-U-15	60 mm	110 mm	JCB-991-00131	79.37
	561-60004	M561011-M579360	I-U-15	60 mm	110 mm	JCB-991-00131	79.37
	561-60015	M561011-M579360	I-U-10	60 mm	110 mm	JCB-991-00110	46.01
LOG GRAB	545-45300	M561011-M579360	I-U-10	1-1/2"	2-3/8"	JCB-545-45307	28.29
MANURE FORK	980-35601	M561011-M579360	I-U-10	1-1/2"	3"	JCB-980-35603	39.54
STEERING - Front	551-06200	M561011-M579360	I-U-10	25 mm	50 mm	JCB-993-46200K	30.93
STEERING - Front & Rear	551-06400	M561011-M579360	I-U-10	25 mm	50 mm	JCB-991-00071	25.74
	551-08500	M568555	I-U-10	25 mm	50 mm	JCB-991-00054	33.67
	551-10100	M561011-M579360	I-U-10	25 mm	50 mm	JCB-991-00097	25.11
STEERING - Front, JCB Option	993-46200	M561011-M579360	I-U-10	25 mm	50 mm	JCB-993-46200K	30.93
STEERING - Rear	551-06300	M561011-M579360	I-U-10	25 mm	50 mm	JCB-993-46200K	30.93
STEERING - Rear, JCB Option	993-46400	M561011-M579360	I-U-10	25 mm	50 mm	JCB-993-46200K	30.93
SWAY	561-24800	M569212	I-U-15	50 mm	110 mm	JCB-991-00126	36.90
	561-60012	M561011-M579360	I-U-15	50 mm	110 mm	JCB-991-00126	36.90
	561-60023	M561011-M579360	I-U-10	50 mm	110 mm	JCB-991-00109	48.03
TILT	553-02000	M561011-M579360	I-U-14	30 mm	60 mm	JCB-991-00021	28.80
	553-04300	M561011-M579360	I-U-14	30 mm	60 mm	JCB-991-00021	28.80
	561-23900	M561307	I-U-15	50 mm	110 mm	JCB-991-00126	36.90

Replacement Kits For

JCB

JCB

Loadall							
APPLICATION	CYL #	SERIAL #	CODE	ROD	BORE	KIT #	List \$
MODEL 505-22, 505-22 SWAY							
TILT TOW HITCH	561-33500	M569262	I-U-15	50 mm	110 mm	JCB-991-00126	36.90
	561-60009	M561011-M579360	I-U-15	50 mm	110 mm	JCB-991-00126	36.90
	561-60020	M561011-M579360	I-U-10	50 mm	110 mm	JCB-991-00109	48.03
	556-31100	M561011-M579360	I-U-10	30 mm	70 mm	JCB-991-00069	20.18
	556-42200	M568560	I-U-10	30 mm	70 mm	JCB-991-00099	35.27
	556-46700	M561011-M579360	I-U-10	30 mm	70 mm	JCB-991-00099	35.27
MODEL 506B							
DISPLACEMENT	563-60012	M570000	I-U-10	65 mm	120 mm	JCB-991-00115	64.42
EXTENSION	903-05900	M570000	I-U-10	70 mm	110 mm	JCB-991-00112	91.90
	903-06100	M570000	I-U-10	70 mm	110 mm	JCB-991-00112	91.90
	561-60018	M570000	I-U-10	65 mm	110 mm	JCB-991-00111	82.69
LIFT	551-10100	M570000	I-U-10	25 mm	50 mm	JCB-991-00097	25.11
STEERING - Front & Rear	561-60012	M570000	I-U-15	50 mm	110 mm	JCB-991-00126	36.90
SWAY	561-60023	M570000	I-U-10	50 mm	110 mm	JCB-991-00109	48.03
TILT	563-60011	M570000	I-U-10	65 mm	120 mm	JCB-991-00115	64.42
MODEL 525B-4HL							
ATTACHMENT	545-45300	M272000-M276567	I-U-10	1-1/2"	2-3/8"	JCB-545-45307	28.29
BOOM LIFT	563-08300	M272000-M276567	I-SP-15	65 mm	120 mm	JCB-563-08300K	69.79
DISPLACEMENT	561-09900	M272000-M276567	I-U-15	60 mm	110 mm	JCB-991-00058	79.37
EXTENSION	556-08300	M272050	I-SP-15	50 mm	70 mm	JCB-556-08300K	52.85
	556-12900	M272000-M276567	I-SP-15	50 mm	70 mm	JCB-556-08300K	52.85
EXTENSION w/ Check Valve	556-13400	M272000-M276567	I-SP-15	50 mm	70 mm	JCB-556-08300K	52.85
LIFT - 7' Mast - 1st Stage	547-41700	M272000-M276567	P-U-10	2"	2-1/2"	JCB-991-03900	26.40
LIFT - 7' Mast - 2nd Stage	547-41700	M272000-M276567	I-U-15	2-7/8"	3-1/2"	JCB-991-03800	37.82
TILT	561-29600	M272000-M276567	I-SP-15	60 mm	110 mm	JCB-561-10200K	71.01
TILT - Side	553-04300	M272000-M276567	I-U-14	30 mm	60 mm	JCB-991-00021	28.80
MODEL 530B-4HL							
ATTACHMENT	545-45300	M580001-M584435	I-U-10	1-1/2"	2-3/8"	JCB-545-45307	28.29
BOOM LIFT	561-13800	M580970	I-U-15	60 mm	110 mm	JCB-991-00014	33.26
	561-22400	M580001-M584435	I-U-15	60 mm	110 mm	JCB-991-00029	79.37
	556-23700	M580001-M584435	I-U-15	40 mm	70 mm	JCB-991-00015	25.87
CLAMSHOVEL	556-31900	M580001-M584435	I-U-15	40 mm	70 mm	JCB-991-00025	33.26
DISPLACEMENT	563-05600	M580001-M584435	I-U-15	65 mm	120 mm	JCB-991-00030	60.26
EXTENSION - Inner	557-06700	M580001-M584435	I-SP-15	60 mm	90 mm	JCB-557-06700K	74.40
EXTENSION - Outer	561-17200	M581764	I-U-15	60 mm	110 mm	JCB-991-00014	33.26
	561-29500	M580001-M584435	I-U-15	60 mm	110 mm	JCB-991-00029	79.37
LIFT - 7' Mast - 1st Stage	547-41700	M580001-M584435	P-U-10	2"	2-1/2"	JCB-991-03900	26.40
LIFT - 7' Mast - 2nd Stage	547-41700	M580001-M584435	I-U-15	2-7/8"	3-1/2"	JCB-991-03800	37.82
STABILIZER	559-23100	M580810	I-U-15	60 mm	100 mm	JCB-991-00012	34.62
	559-32200	M580001-M584435	I-U-15	60 mm	100 mm	JCB-991-00028	76.95
TILT	563-23700	M580001-M584435	I-U-15	65 mm	120 mm	JCB-991-00030	60.26
TILT - Side	553-04300	M580001-M584435	I-U-14	30 mm	60 mm	JCB-991-00021	28.80

REPLACEMENT KITS FOR JCB

Kit Number	Rod X Bore Size	List Price
JCB-545-45307	1-1/2 X 2-3/8	\$ 28.29
JCB-547-42102	7/8 X 2	12.84
JCB-556-08300K	50 X 70 mm	52.85
JCB-556-24900K	50 X 70 mm	64.95
JCB-557-06700K	60 X 90 mm	74.40
JCB-561-10200K	60 X 110 mm	71.01
JCB-563-08300K	65 X 120 mm	69.79
JCB-903-10301	1-3/8 X 2	25.09
JCB-980-35603	1-1/2 X 3	39.54
JCB-983-00154	50 X 100 mm	49.77
JCB-991-00003	2 X 4	33.17
JCB-991-00012	60 X 100 mm	34.62
JCB-991-00013	50 X 90 mm	31.07
JCB-991-00014	60 X 110 mm	33.26
JCB-991-00015	40 X 70 mm	25.86
JCB-991-00016	50 X 80 mm	33.26
JCB-991-00017	30 X 60 mm	34.76
JCB-991-00018	110 mm Piston Kit	18.49
JCB-991-00020	30X 60 mm	17.77
JCB-991-00021	30 X 60 mm	28.80
JCB-991-00025	40 X 70 mm	31.38
JCB-991-00026	50 x 80 mm	70.99
JCB-991-00027	50 x 90 mm	70.99
JCB-991-00028	60 X 100 mm	76.95
JCB-991-00029	60 X 110 mm	79.37
JCB-991-00030	65 X 120 mm	60.26
JCB-991-00036	30 X 70 mm	26.21
JCB-991-00054	25 X 50 mm	33.68
JCB-991-00055	60 X 100 mm	76.95
JCB-991-00058	60 X 110 mm	79.37
JCB-991-00061	50 X 80 mm	70.99
JCB-991-00069	30 X 70 mm	20.18
JCB-991-00071	25 X 50 mm	25.74
JCB-991-00095	40 X 70 mm	33.34

Kit Number	Rod X Bore Size	List Price
JCB-991-00096	50 X 90 mm	\$ 70.99
JCB-991-00097	25 X 50 mm	25.11
JCB-991-00098	30 X 60 mm	33.29
JCB-991-00099	30 X 70 mm	35.27
JCB-991-00100	40 X 70 mm	33.34
JCB-991-00102	50 X 80 mm	44.88
JCB-991-00103	50 X 90 mm	47.36
JCB-991-00105	50 X 70 mm	47.33
JCB-991-00109	50 X 110 mm	48.04
JCB-991-00110	60 X 110 mm	46.01
JCB-991-00111	65 X 110 mm	82.69
JCB-991-00112	70 X 110 mm	91.90
JCB-991-00115	65 X 120 mm	64.42
JCB-991-00120	70 X 130 mm	79.05
JCB-991-00122	40 X 70 mm	33.69
JCB-991-00123	50 X 80 mm	47.13
JCB-991-00126	50 X 110 mm	36.90
JCB-991-00127	50 X 90 mm	70.99
JCB-991-00130	60 X 100 mm	76.95
JCB-991-00131	60 X 110 mm	79.37
JCB-991-00135	65 X 120 mm	60.26
JCB-991-00144	70 X 140 mm	103.69
JCB-991-00145	60 X 100 mm	46.22
JCB-991-00146	65 X 110 mm	54.66
JCB-991-00147	60 X 90 mm	59.67
JCB-991-00148	60 X 110 mm	65.51
JCB-991-00152	60 X 100 mm	44.33
JCB-991-00156	45 X 75 mm	56.61
JCB-991-03800	2-7/8 X 3-1/2	37.82
JCB-991-03900	2 X 2-1/2	26.40
JCB-993-34509	1 X 2-1/2	13.86
JCB-993-46200K	25 X 50 mm	30.93
JCB-997-00908	1-1/2 X 2-1/2	84.48



REPLACEMENT KITS FOR JLG INDUSTRIES

JLG

Kit Number	Code (Pg. x)	Rod X Bore Size	List Price
JLG-2900003	N-N-11	5" SWIVEL KIT	\$ 120.69
JLG-2900005	P-V-1	2 X 3	33.05
JLG-2900006	P-V-11	2 X 5	37.79
JLG-2900007	I-U, V-11	1 X 3	28.63
JLG-2900008	P-V-11	1 X 3	23.96
JLG-2900009	P-V-11	2 X 4	36.69
JLG-2900010	P-V-11	2-1/2 X 6	56.79
JLG-2900088	P-U-8	3 X 7	203.68
JLG-2900094	P-U-10	2 X 3	54.59
JLG-2900095	P-U-10	1-1/4 X 2-1/2	42.35
JLG-2900099	I-U-11	1-1/4 X 2-1/4	16.08
JLG-2900100	I-U-10, 12	2 X 6	73.42
JLG-2900101	P-V-11	1 X 2	21.95
JLG-2900102	P-V-11	2 X 3	27.79
JLG-2900103	P-V-11	1-1/4 X 3	25.06
JLG-2900104	I-U-11	1 X 3	12.87
JLG-2900107	P-V-11	1-1/2 X 4	32.65
JLG-2900108	I-U-10, 12	3-1/2 X 8	94.79
JLG-2900109	P-U-11	1 X 3	16.70
JLG-2900109M	P-U-13	1 X 3	17.88
JLG-2900110	P-U-11	1-1/2 X 4	22.42
JLG-2900111	P-U-11	1-1/4 X 3	17.91
JLG-2900111M	P-U-13	1-1/4 X 3	18.19
JLG-2900112	I-U-10, 12	2 X 5	55.16
JLG-2900113	I-U-10, 12	3-1/2 X 9	116.85
JLG-2900114	P-V-1	3-1/2 X 8	48.61
JLG-2900119	I,P,U-11	1-1/4 X 3	22.27
JLG-2900120	PUMP SEAL KIT		119.98
JLG-2900123	P-U-11	2 X 4	33.69
JLG-2900124	I-U-11	1 X 2	11.08
JLG-2900125	I-U-11	2 X 3	15.87
JLG-2900126	P-U-11	1-1/4 X 3	17.96
JLG-2900127	N-N-11	5-7/8" SWIVEL KIT	146.32
JLG-2900142	P-U-11	2-1/2 X 6	46.54
JLG-2900156	I-U-11	1 X 2	11.08
JLG-2900157	I-U-11	2-1/2 X 4	28.63
JLG-2900158	VALVE KIT		24.60
JLG-2900166	P-U-11	1-1/4 X 2	15.24
JLG-2900168	MOTOR KIT		17.33
JLG-2900173	P-U-11	2 X 4	31.68
JLG-2900175	I-OB-2	1/2 X 1	12.78
JLG-2900184	N-U-10, 12	2 X 3	27.01
JLG-2900188	P-O-11	3/4 X 2	11.88
JLG-2900197	P-U-11	2 X 3	27.81
JLG-2900203	I-U-11	3 X 4	26.03
JLG-2900208	I-U-11	2 X 3	21.87
JLG-2900209	I-U-11	2 X 5	35.84
JLG-2900242	P-O-11	3/4 X 2	16.75
JLG-2900292	P-U-11	2-1/2 X 6	43.69
JLG-2900293	I-U-11	3 X 5	38.03

Kit Number	Code (Pg. x)	Rod X Bore Size	List Price
JLG-2900295	I-U-10	1-1/4 X 3	\$ 20.39
JLG-2900338	P-U-1	3-1/2 X 8	162.23
JLG-2900344	P-U-10	1 X 2 DOUBLE ROD	52.39
JLG-2900347	P-U-1	2 X 3	61.47
JLG-2900347	P-U-1	2 X 3	61.47
JLG-2900348	P-U-10	1-1/4 X 3	58.59
JLG-2900350	P-U-11	2 X 3	31.39
JLG-2900351	I-U-10	1-1/2 X 3	40.78
JLG-2900352	P-U-10	1-1/4 X 2-1/2	48.70
JLG-2900357	P-U-10	2 X 3	46.49
JLG-2900364	P-U-10	1-1/4 X 3	30.21
JLG-2900367	P-U-11	1-1/4 X 3	42.37
JLG-2900368	P-U-11	2 X 3	84.59
JLG-2900381	P-U-11	1-1/4 X 2-1/2	23.10
JLG-2900398	P-U-11	1-1/2 X 2-1/2	58.43
JLG-2900400	O-RING KIT		2.40
JLG-2900408	I-U-11	1 X 2	13.44
JLG-2900409	2-1/2, 3-1/2 STAGES		20.42
JLG-2900412	2-1/2, 3-1/2, 4-5/8 STAGES		39.26
JLG-2900426	P-U-11	1-1/4 X 3	27.79
JLG-2900427	1-5/8" SWIVEL KIT		9.82
JLG-2900429	P-U-11	1-1/2 X 2-1/2	21.65
JLG-2900431	P-U-11	2 X 4	24.57
JLG-2900432	P-U-11	2 X 3	30.90
JLG-2900432M	P-U-13	2 X 3	26.33
JLG-2900454	P-U-11	1-1/2 X 4	22.40
JLG-2900469	P-U-11	2 X 5	35.79
JLG-2900473	I-U-10, 12	4 X 5-1/2	74.77
JLG-2900485	P-U-10	3/4 X 2	20.51
JLG-2900499	2-1/2, 3-1/2, 4-5/8 STAGES		60.18
JLG-2900511	2-1/2, 3-1/2 STAGES		35.68
JLG-2900578	I-U-11	1-1/4 X 2	16.75
JLG-2900579	P-U-9	2-1/2 X 5	115.30
JLG-2900683	O-RING KIT		3.34
JLG-2900700	P-OB-3	1-1/8 X 2	7.94
JLG-2900701	N-OB-13	1 X 1-1/2	7.22
JLG-2901007	I-U-10	2 X 3-1/2	19.67
JLG-2901009	O-RING KIT		5.07
JLG-2901034	I-OB-3	1-1/2 X 3-1/2	7.27
JLG-2901103	P-U-11	1-1/2 X 4	82.97
JLG-2901105	P-U-11	2-1/2 X 6	49.63
JLG-2901115	P-U-10	3 X 5	45.82
JLG-2901119	P-U-11	1-1/4 X 2-1/2	21.25
JLG-2901127	P-U-13	1 X 3	17.88
JLG-2901133	P-U-13	1-1/4 X 3	18.19
JLG-2901138	P-U-13	1-1/2 X 4	22.05
JLG-2901146	5" SWIVEL KIT		86.46
JLG-2901180	P-U-9	2-3/4 X 3-1/2	107.34
JLG-7000312	1-1/2" PISTON KIT		13.97

NOTES

Kingseal Co., Ltd. Thailand

REPLACEMENT SEAL KITS FOR J.I. CASE EQUIPMENT*

Replacement Seal Kits By Machine Type

Table of Contents

Machine Type		Page
Excavators	880, 880B, 880C, 880D, 880R, 9010B, 9020B, 9030B	302
Skid Steer Loaders	95XT, 1818, 1825, 1835, 1835B, 1835C, 1838, 1840, 1845, 1845S, 1845B, 1845C	302 - 304
Track-Type Dozers/Loaders	310E, 310F with Backhoe Model 31, 310G with Backhoe Models 26, 26B, 26S, 32, 33, 350 with Backhoe Models 26, 26B, 26C, 26S, 350B with Backhoe Models 26C, 26D, 420C, 450 with Backhoe Models 26, 26B, 26C, 26S, 32, 33, 35, 450B, 450C, 455B, 455C with Backhoe Models 26D, 35, 475 Cable Layer, 750 with Backhoe Models 32, 33S, 34, 850 with Backhoe Models 34, 35, 36, 850B with Backhoe Model 35, 850C, 855C with Backhoe Models 35A, 35A, 35C WL, 3, 850D with Backhoe Models 35C, 35C WL, 1150 with Backhoe Models 32, 34, 36, 1150B, 1150C, 1150D, 1155D, 1450, 1450B, 1455B	304 - 317
Uni-Loaders	1530B, 1700, 1816B, 1816C, 1830, 1835, 1835B, 1845, 1845B, 1845C, 1845S	317 - 318
Unimogs	MB4/94 with Model 26C Backhoe, P80 Cable Plow, T70	318
Wheel Loaders 21-Series	621, 621B, 721, 721B, 821, 821B, 921	319 - 320
Wheel Loaders W-Series	W3, W7, W7C, W7E, W8E, W9, W9A, W9B, W9C, W9E, W10, W10B, W10C, W10E, W11, W11B, W14, W14L, W14H, W14B, W18, W20, W20B, W18B, W20C, W24, W24B, W24C, W26B, W26FL, W30, W36	320 - 324
Wheeled Backhoe Loaders	380LL, 430 with Backhoe Models 21, 22, 23, 480, 480B with Backhoe Models 23, 26, 26B, 26S, 480C, 480D, 480D LL, 480E, 480E LL, 480F, 480F LL, 530 with Backhoe Models 31, 32, 32S, 580 with Backhoe Models 33, 33S, 580 Super E, 580 Super L, 580B with Backhoe Model 35, 580C, 580D, 580 Super D, 580F, 580K, 580L, 580SK, 580SL Construction King, 590, 590 Super L, 680, 680B, 680C, 680CK, 680E, 680G, 680H, 680K, 680L, 780, 780B	324 - 337
Alpha-Numeric Kit Listing		338 - 340
J.I. Case Individual Parts		341 - 342



KINGSEAL CO., LTD. THAILAND

46/152-153 Moo 3 Sri Saman Road
Baan Mai Pakkret, Nonthaburi Thailand 11120

Tel: +662 9617534 to 6

Fax: +662 9617540

Email: intlsales@kingseal.co.th / kingsealmail@gmail.com

Website: <http://www.kingseal.co.th>

All manufacturer's names, part numbers and descriptions are used for reference purposes only. We do not imply that any part shown is the product of these manufacturers. We also do not imply that the list price shown is exactly that of the manufacturer.

Replacement Kits For

J.I. CASE

J.I. CASE

Excavators								
APPLICATION	CYL #	Piston	SERIAL #	CODE	ROD	BORE	KIT #	List \$
MODEL 880								
ARM		2PC	6200000-6201114	P-UB-9	2-1/2	5-1/2	JIC-G105514	42.50
		2PC	6201115-UP	P-UB-9	2-3/4	5-1/2	JIC-G105566	68.60
BOOM		2PC	6200000-6201114	P-UB-9	2-1/2	5-1/2	JIC-G105514	42.50
		2PC	6201115-UP	P-UB-9	2-3/4	5-1/2	JIC-G105566	68.60
BUCKET		2PC		P-UB-9	2-1/2	5	JIC-G105515	40.25
EXT. BUCKET		2PC		P-UB-9	3	5	JIC-G105531	46.07
EXT. DIPPER		1PC		P-UB-10	2-1/4	4	JIC-G105556	33.28
		2PC		P-UB-9	2-1/2	4	JIC-G34636	33.71
MODEL 880B, 880C, 880D								
ARM		2PC		P-UB-9	2-3/4	5-1/2	JIC-G105566	68.60
BOOM		2PC		P-UB-9	2-3/4	5-1/2	JIC-G105566	68.60
BUCKET		2PC		P-UB-9	2-1/2	5	JIC-G109499	53.06
MODEL 880R								
ARM		2PC		P-UB-9	2-3/4	5-1/2	JIC-G105566	68.60
BOOM		2PC		P-UB-9	2-3/4	5-1/2	JIC-G105566	68.60
EXT. BUCKET		2PC		P-UB-9	3	5	JIC-G105531	46.07
EXT. DIPPER		2PC	-->5352380	P-UB-9	2-1/2	4	JIC-G34636	33.71
		1PC	5352381-UP	P-UB-10	2-1/4	4	JIC-G105556	33.28
MODEL 9010B								
ARM		1PC		P-UB-10	80 mm	115 mm	JIC-164494A1	183.32
BOOM		1PC		P-UB-10	75 mm	100 mm	JIC-164493A1	114.61
BUCKET		1PC		P-UB-10	70 mm	95 mm	JIC-162976A1	160.36
MODEL 9020B								
ARM		1PC		P-UB-10	90 mm	125 mm	JIC-161913A1	207.78
BOOM		1PC		P-UB-10	80 mm	115 mm	JIC-161912A1	173.97
BUCKET		1PC		P-UB-10	75 mm	105 mm	JIC-161914A1	182.65
MODEL 9030B								
ARM (long reach model)		1PC		P-UB-10	105 mm	150 mm	JIC-160227A1	245.32
ARM (w/o long reach)		1PC		P-UB-10	100 mm	135 mm	JIC-160579A1	235.59
BOOM (w/ load option)		1PC		P-UB-10	85 mm	125 mm	JIC-164183A1	164.36
BOOM (w/o load option)		1PC		P-UB-10	85 mm	125 mm	JIC-160577A1	165.10
BUCKET (long reach model)		1PC		P-UB-10	70 mm	95 mm	JIC-162976A1	160.36
BUCKET (w/o long reach)		1PC		P-UB-10	80 mm	120 mm	JIC-160581A1	153.39
Skid Steer Loaders								
APPLICATION	CYL #	Piston	SERIAL #	CODE	ROD	BORE	KIT #	List \$
MODEL 95XT								
BACKHOE BOOM	1346450C2	1PC		P-UB-10	1-1/2	3	JIC-1543256C1	37.80
BACKHOE BUCKET	1346397C2	1PC		P-UB-10	1-1/2	2-3/4	JIC-1346409C2	62.47
BACKHOE DIPPER	1346411C2	1PC		P-UB-10	1-1/2	3	JIC-1543256C1	37.80
BACKHOE SWING	H673149			P-OB-1	2-3/4		JIC-H53041	20.77
LOADER LIFT	139091A3	1PC		P-UB-10,12	1-3/4	2-1/2	JIC-198376A2	32.86
STABILIZER (Fold Down)	101643A1	1PC		P-U-10	1-3/8	3	JIC-700710260	50.59
STABILIZER (Vertical)	H514117	1PC		P-U-10	1	2	JIC-H52704	10.54
TRENCHER BOOM LIFT	221700A1	1PC		P-U-10	1-3/4	3-1/2	JIC-235933A1	20.41

Replacement Kits For

J.I. CASE

J.I. CASE

Skid Steer Loaders								
APPLICATION	CYL #	Piston	SERIAL #	CODE	ROD	BORE	KIT #	List \$
MODEL 1818								
BUCKET TILT	D136128	1PC		P-U-10	1	2	JIC-N14638	32.28
LOADER BUCKET	104517A1	1PC		P-U-10	1	2	JIC-110510A1	49.87
LOADER LIFT	104516A1	1PC		P-U-10	1-3/8	2	JIC-110507A1	49.87
	D136838	1PC		P-U-10	1-1/4	2	JIC-N14639	39.59
MODEL 1825								
BUCKET TILT	D136128	1PC		P-U-10	1	2	JIC-N14638	32.28
LOADER BUCKET	104517A1	1PC		P-U-10	1	2	JIC-110510A1	49.87
LOADER LIFT	104516A1	1PC		P-U-10	1-3/8	2	JIC-110507A1	49.87
	D136838	1PC		P-U-10	1-1/4	2	JIC-N14639	39.59
MODEL 1835								
GRAPPLE	D61075	1PC		P-U-10	1	2	JIC-D61006	5.06
LOADER BUCKET		1PC		P-UB-10	1-1/4	2-1/2	JIC-G109476	20.94
	G103407	1PC		P-U-10	1-1/4	2-1/8	JIC-G105507	17.28
LOADER LIFT		1PC		P-UB-10	1-1/2	2-1/2	JIC-G109458	15.37
	G34864	1PC		P-U-10	1-1/4	2-1/8	JIC-G34819	22.48
MODEL 1835B								
GRAPPLE	D61075	1PC		P-U-10	1	2	JIC-D61006	5.06
LOADER BUCKET	G103407	1PC		P-UB-10	1-1/4	2-1/2	JIC-G109476	20.94
LOADER LIFT		1PC		P-UB-10	1-1/2	2-1/2	JIC-G109458	15.37
	G106818	1PC		P-UB-10	1-1/2	2-1/2	JIC-128725A1	27.05
MODEL 1835C								
BUCKET TILT	118110A1	1PC	JAF0130838-UP	P-U-10	1-1/4	2-1/2	JIC-128728A1	22.91
	G103407	1PC	-->PIN JAF0130838	P-U-10	1-1/4	2-1/2	JIC-128728A1	22.91
GRAPPLE	D61075	1PC		P-U-10	1	2	JIC-D61006	5.06
LIFT		1PC		P-U-10	1-1/4	2-1/8	JIC-G34819	22.48
	117824A1	1PC	JAF0130838-UP	P-UB-10	1-1/2	2-1/2	JIC-128725A1	27.05
	G110666	1PC	-->JAF0130838	P-UB-10	1-1/2	2-1/2	JIC-128725A1	27.05
MODEL 1838								
BACKHOE BOOM, DIPPER, & BUCKET	G100936	1PC		P-UB-10	1-1/2	3	JIC-1543252C1	40.13
BACKHOE DIPPER	G109376	1PC		P-UB-10	1-1/2	3	JIC-1543313C1	27.49
BACKHOE SWING	H514125			P-OB-1	2-3/4		JIC-H53041	20.77
GRAPPLE	D61010	1PC		P-U-10	1	2	JIC-D61006	5.06
LOADER BUCKET TILT	118110A1	1PC		P-U-10	1-1/4	2-1/2	JIC-128728A1	22.91
LOADER LIFT	117824A1	1PC		P-UB-10	1-1/2	2-1/2	JIC-128725A1	27.05
STABILIZER (Fold Down)	101643A1	1PC		P-U-10	1-3/8	3	JIC-700710260	50.59
STABILIZER (Vertical)	H514117	1PC		P-U-10	1	2	JIC-H52704	10.54
MODEL 1840								
BACKHOE BOOM	1346450C2	1PC		P-UB-10	1-1/2	3	JIC-1543256C1	37.80
BACKHOE BUCKET	1346397C2	1PC		P-UB-10	1-1/2	2-3/4	JIC-1346409C2	62.47
BACKHOE DIPPER	1346411C1	1PC		P-UB-10	1-1/2	3	JIC-1543256C1	37.80
BACKHOE SWING	H673149			P-OB-1	2-3/4		JIC-H53041	20.77
GRAPPLE	D61075	1PC		P-U-10	1	2	JIC-D61006	5.06
LOADER BUCKET TILT	118110A1	1PC		P-U-10	1-1/4	2-1/2	JIC-128728A1	22.91
	G103407	1PC		P-U-10	1-1/4	2-1/2	JIC-128728A1	22.91

Replacement Kits For

J.I. CASE

J.I. CASE

Skid Steer Loaders								
APPLICATION	CYL #	Piston	SERIAL #	CODE	ROD	BORE	KIT #	List \$
MODEL 1840								
LOADER LIFT	117824A1	1PC		P-UB-10	1-1/2	2-1/2	JIC-128725A1	27.05
	G110666	1PC		P-UB-10	1-1/2	2-1/2	JIC-128725A1	27.05
STABILIZER (Vertical)	H514117	1PC		P-U-10	1	2	JIC-H52704	10.54
MODEL 1845, 1845S								
4-IN-1 BUCKET	G33748	1PC		P-UB-10	1-1/2	3	JIC-1543313C1	27.49
BUCKET DUMP	G34926	1PC		P-U-10	1-1/4	2-1/8	JIC-G105507	17.28
LOADER LIFT - 1845	G37917	1PC		P-UB-10	1-1/2	2-1/2	JIC-128725A1	27.05
LOADER LIFT - 1845S	G100295	1PC		P-UB-10	1-1/2	2-1/2	JIC-128725A1	27.05
SCARIFIER	G33744	1PC		P-UB-10	1-1/2	3	JIC-1543313C1	27.49
MODEL 1845B								
LOADER BUCKET	G34926	1PC		P-UB-10	1-1/4	2-1/2	JIC-G109476	20.94
LOADER CLAM	G33748	1PC		P-UB-10	1-1/2	3	JIC-1543313C1	27.49
LOADER LIFT	G100295	1PC		P-UB-10	1-1/2	2-1/2	JIC-128725A1	27.05
SCARIFIER	G33744	1PC		P-UB-10	1-1/2	3	JIC-1543313C1	27.49
MODEL 1845C								
BACKHOE BOOM	1346450C2	1PC		P-UB-10	1-1/2	3	JIC-1543256C1	37.80
BACKHOE BUCKET	1346397C2	1PC		P-UB-10	1-1/2	2-3/4	JIC-1346409C2	62.47
BACKHOE DIPPER	1346411C1	1PC		P-UB-10	1-1/2	3	JIC-1543256C1	37.80
	G109376	1PC		P-UB-10	1-1/2	3	JIC-1543313C1	27.49
BACKHOE SWING	H673149			P-OB-1	2-3/4		JIC-H53041	20.77
BOOM, DIPPER, & BUCKET	G100936	1PC		P-UB-10	1-1/2	3	JIC-1543252C1	40.13
LOADER BUCKET	G34926	1PC		P-U-10	1-1/4	2-1/2	JIC-128728A1	22.91
LOADER LIFT	117903A1	1PC		P-UB-10	1-1/2	2-1/2	JIC-128725A1	27.05
	129011A1	1PC		P-UB-10	1-1/2	2-1/2	JIC-128725A1	27.05
	G109773	1PC		P-UB-10	1-1/2	2-1/2	JIC-128725A1	27.05
	G109777	1PC		P-UB-10	1-1/2	2-1/2	JIC-128725A1	27.05
STABILIZER	101643A1	1PC		P-U-10	1-3/8	3	JIC-700710260	50.59
	H514117	1PC		P-U-10	1	2	JIC-H52704	10.54
	H672226	1PC		P-U-10	1-3/8	3	JIC-700710260	50.59
SWING	H514125			P-OB-1	2-3/4		JIC-H53041	20.77
Track-Type Dozers/Loaders								
APPLICATION	CYL #	Piston	SERIAL #	CODE	ROD	BORE	KIT #	List \$
MODEL 310E, 310F with Backhoe Model 31								
BACKHOE BOOM				I-U-1	2		JIC-D42876	9.31
		2PC		N-N-9		4	JIC-G33239	13.44
		2PC		P-U-9	2	4	JIC-G32616	26.97
		2PC		N-N-9		3-1/2	JIC-G33237	12.32
		2PC		P-U-9	1-3/4	3-1/2	JIC-G105518	29.21
BACKHOE BUCKET				P-U-1	1-3/4		JIC-D42873	13.78
		2PC		P-UB-9	2	4	JIC-G105526	30.90
		2PC		N-N-9		4	JIC-G33239	13.44
BACKHOE DIPPER				I-U-1	2		JIC-D42876	9.31
		2PC		N-N-9		3-1/2	JIC-G33237	12.32
BACKHOE STABILIZER				P-U-1	1-3/4		JIC-D42873	13.78

Replacement Kits For

J.I. CASE

J.I. CASE

Track-Type Dozers/Loaders								
APPLICATION	CYL #	Piston	SERIAL #	CODE	ROD	BORE	KIT #	List \$
MODEL 310E, 310F with Backhoe Model 31								
BACKHOE SWING		2PC		N-N-9		4	JIC-G33239	13.44
			2019001-3023000	P-U-1	1-3/4		JIC-D42875	10.67
DOZER ANGLING				P-U-1	1-3/4		JIC-D42873	13.78
		2PC		N-N-9		3-1/2	JIC-G33237	12.32
DOZER LIFT		2PC		N-N-9		2-1/2	JIC-G33193	10.85
				P-U-1	1-1/4		JIC-D42867	10.76
DOZER TILT				P-U-1	1-1/4		JIC-D42867	10.76
		2PC		N-N-9		2-1/2	JIC-G33193	10.85
LOADER LIFT		2PC		N-N-9		3-1/2	JIC-G33237	12.32
				P-U-1	1-3/4		JIC-D42873	13.78
LOADER TILT		2PC		N-N-9		2-1/2	JIC-G33193	10.85
				P-U-1	1-1/4		JIC-D42867	10.76
SCARIFIER		2PC		N-N-9		3	JIC-G33151	11.12
				P-U-1	1-1/2		JIC-D42870	13.42
MODEL 310G with Backhoe Models 26, 26B, 26S, 32, 33								
BACKHOE BOOM			3023001.3032323	P-U-1	1-3/4		JIC-D42873	13.78
		2PC	3023001.3032324	N-N-9		3-1/2	JIC-G33237	12.32
		2PC	3023001.3032325	P-UB-9	1-3/4	3-1/2	JIC-G105529	27.40
		2PC	3023001.3032326	P-UB-9	2-1/2	4	JIC-G34636	33.71
			3023001.3032327	I-U-1	2		JIC-D42876	9.31
		2PC	3023001.3032328	N-N-9		4	JIC-G33239	13.44
		2PC	3023001.3032329	P-U-9	2	4	JIC-G32299	29.21
		2PC	3023001.3032330	P-UB-9	2	4	JIC-G105517	29.71
			3023001.3032331	P-U-1	2-1/4		JIC-D42878	12.24
		2PC	3023001.3032332	N-N-9		4-1/2	JIC-DTVS4.5P	26.62
		2PC	3023001.3032333	P-UB-9	2-1/4	4-1/2	JIC-G105520	47.70
BACKHOE BUCKET			3023001.3032334	P-U-1	1-3/4		JIC-D42872	10.05
		2PC	3023001.3032335	N-N-9		3-1/2	JIC-G33237	12.32
		2PC	3023001.3032336	P-UB-9	1-3/4	3	JIC-G105524	32.34
			3023001.3032337	P-U-1	1-3/4		JIC-D42873	13.78
		2PC	3023001.3032338	N-N-9		3-1/2	JIC-G33237	12.32
			3023001.3032339	I-U-1	2		JIC-D42874	9.05
		2PC	3023001.3032340	N-N-9		3-1/2	JIC-G33237	12.32
		2PC	3023001.3032341	P-U-9	2	3-1/2	JIC-G32293	26.40
		2PC	3023001.3032342	P-UB-9	2	3-1/2	JIC-G105527	32.20
BACKHOE DIPPER			3023001.3032343	I-U-1	2		JIC-D42874	9.05
		2PC	3023001.3032344	N-N-9		3-1/2	JIC-G33237	12.32
		2PC	3023001.3032345	P-U-9	2	3-1/2	JIC-G32293	26.40
		2PC	3023001.3032346	P-UB-9	2	3-1/2	JIC-G105527	32.20
			3023001.3032347	I-U-1	2		JIC-D42876	9.31
		2PC	3023001.3032348	N-N-9		4	JIC-G33239	13.44
		2PC	3023001.3032349	P-U-9	2	4	JIC-G32299	29.21
		2PC	3023001.3032350	P-UB-9	2	4	JIC-G105517	29.71
		2PC	3023001.3032351	P-UB-9	1-1/2	3	JIC-G105512	29.35
BACKHOE STABILIZER			3023001.3032308	P-U-1	1-1/2		JIC-D42870	13.42

Replacement Kits For

J.I. CASE

J.I. CASE

Track-Type Dozers/Loaders									
APPLICATION	CYL #	Piston	SERIAL #	CODE	ROD	BORE	KIT #	List \$	
MODEL 310G with Backhoe Models 26, 26B, 26S, 32, 33									
BACKHOE STABILIZER		2PC	3023001.3032309	N-N-9		3	JIC-G33151	11.12	
			3023001.3032310	P-U-1	1-3/4		JIC-D42872	10.05	
		2PC	3023001.3032311	N-N-9		3	JIC-G33151	11.12	
		2PC	3023001.3032312	P-UB-9	1-3/4	3	JIC-G105524	32.34	
			3023001.3032313	P-U-1	1-3/4		JIC-D42873	13.78	
		2PC	3023001.3032314	N-N-9		3-1/2	JIC-G33237	12.32	
		2PC	3023001.3032315	P-UB-9	1-3/4	3-1/2	JIC-G105529	27.40	
BACKHOE SWING		2PC	3023001.3032316	P-U-9	1-3/4	3-1/2	JIC-G105518	29.21	
			3023001.3032317	P-U-1	1-1/2		JIC-D47896	10.83	
		2PC	3023001.3032318	N-N-9		3-1/2	JIC-G33237	12.32	
		2PC	3023001.3032319	P-U-9	1-1/2	3-1/2	JIC-G34652	25.71	
		2PC	3023001.3032320	P-UB-9	1-3/4	4	JIC-G105519	28.02	
DOZER ANGLING			3023001.3032321	P-U-1	1-3/4		JIC-D42875	10.67	
		2PC	3023001.3032322	N-N-9		4	JIC-G33239	13.44	
		2PC	3023001.3032301	P-U-9	1-3/4	3-1/2	JIC-G34622	29.21	
		2PC	3023001.3032301	N-N-9		3-1/2	JIC-G33237	12.32	
			3023001.3032301	P-U-1	1-3/4		JIC-D42873	13.78	
DOZER LIFT			3023001.3032302	P-U-1	1-1/2		JIC-D42870	13.42	
		2PC	3023001.3032303	N-N-9		3	JIC-G33151	11.12	
		2PC	3023001.3032304	P-UB-9	1-1/2	3	JIC-G105512	29.35	
		2PC	3023001.3032301	N-N-9		2-1/2	JIC-G33193	10.85	
		2PC	3023001.3032301	P-U-9	1-1/4	2-1/2	JIC-G32295	19.66	
DOZER TILT			3023001.3032301	P-U-1	1-1/4		JIC-D42867	10.76	
		2PC	3023001.3032301	N-N-9		2-1/2	JIC-G33193	10.85	
		2PC	3023001.3032301	P-U-9	1-1/4	2-1/2	JIC-G32295	19.66	
EXTENSION			3023001.3032301	P-U-1	1-1/4		JIC-D42867	10.76	
			3023001.3032352	P-U-1	1-3/4		JIC-D42873	13.78	
		2PC	3023001.3032353	N-N-9		3-1/2	JIC-G33237	12.32	
LOADER CLAM		2PC	3023001.3032354	P-UB-9	1-3/4	3-1/2	JIC-G105529	27.40	
	G32460	2PC	3023001.3032301	P-UB-9	1-3/4	3	JIC-G105524	32.34	
	LOADER GRAPPLE	2PC	3023001.3032301	P-U-9	1-1/2	2-1/2	JIC-G32294	20.22	
LOADER HYDRA-LEVELING		2PC	3023001.3032301	N-N-9		2-1/2	JIC-G33193	10.85	
			3023001.3032301	P-U-1	1-1/2		JIC-D42869	13.52	
	D33123	2PC	3023001.3032301	P-U-1	1-1/2		JIC-D42869	13.52	
		D33123	2PC	3023001.3032301	P-U-9	1-1/2	2-1/2	JIC-G32294	20.22
		D33123	2PC	3023001.3032301	N-N-9		2-1/2	JIC-G33193	10.85
LOADER LIFT		2PC	3023001.3032301	P-UB-9	1-3/4	3	JIC-G105524	32.34	
	D33121, D33122		3023001.3032301	P-U-1	1-3/4		JIC-D42872	10.05	
	D33121, D33122	2PC	3023001.3032301	N-N-9		3	JIC-G33151	11.12	
LOADER TILT		2PC	3023001.3032301	N-N-9		2-1/2	JIC-G33193	10.85	
	D33113, D33114		3023001.3032301	P-U-1	1-1/2		JIC-D42869	13.52	
	D33113, D33114	2PC	3023001.3032301	P-U-9	1-1/2	2-1/2	JIC-G32294	20.22	
RIPPER			3023001.3032305	P-U-1	1-1/2		JIC-D42870	13.42	
		2PC	3023001.3032306	N-N-9		3	JIC-G33151	11.12	

Replacement Kits For

J.I. CASE

J.I. CASE

Track-Type Dozers/Loaders								
APPLICATION	CYL #	Piston	SERIAL #	CODE	ROD	BORE	KIT #	List \$
MODEL 310G with Backhoe Models 26, 26B, 26S, 32, 33								
RIPPER		2PC	3023001.3032307	P-UB-9	1-1/2	3	JIC-G105512	29.35
MODEL 350 with Backhoe Models 26, 26B, 26C, 26S								
BACKHOE BOOM		2PC		P-UB-9	1-3/4	3-1/2	JIC-G105529	27.40
		1PC		P-UB-10	2-1/4	4	JIC-G105556	33.28
				P-U-1	1-3/4		JIC-D42873	13.78
BACKHOE BUCKET		2PC		P-UB-9	2-1/2	4	JIC-G34636	33.71
		2PC		N-N-9		3-1/2	JIC-G33237	12.32
		2PC		P-UB-9	1-3/4	3	JIC-G105524	32.34
		1PC		P-UB-10	1-3/4	3	JIC-G105549	32.58
BACKHOE DIPPER		2PC		N-N-9		3-1/2	JIC-G33237	12.32
				P-U-1	1-3/4		JIC-D42872	10.05
		1PC		P-UB-10	2	3-1/2	JIC-G105546	28.82
				I-U-1	2		JIC-D42874	9.05
BACKHOE DIPPER EXT		2PC		N-N-9		3-1/2	JIC-G33237	12.32
		2PC		P-U-9	2	3-1/2	JIC-G32293	26.40
		2PC		P-UB-9	2	3-1/2	JIC-G105527	32.20
BACKHOE STABILIZER		1PC		P-UB-10	1-1/2	3	JIC-G105548	25.60
		2PC		P-UB-9	1-1/2	3	JIC-G105512	29.35
BACKHOE SWING		2PC		N-N-9		3	JIC-G33151	11.12
		2PC		P-UB-9	1-3/4	3-1/2	JIC-G105529	27.40
				P-U-1	1-1/2		JIC-D42870	13.42
				P-U-1	1-3/4		JIC-D42872	10.05
		2PC		P-U-9	1-3/4	3-1/2	JIC-G105518	29.21
		2PC		N-N-9		3	JIC-G33151	11.12
		2PC		P-UB-9	1-3/4	3	JIC-G105524	32.34
		1PC		P-UB-10	1-1/2	3-1/2	JIC-G105555	24.09
				P-U-1	1-1/2		JIC-D47896	10.83
		2PC		N-N-9		3-1/2	JIC-G33237	12.32
DOZER ANGLE		2PC		P-U-9	1-1/2	3-1/2	JIC-G34652	25.71
		2PC		P-UB-9	1-3/4	4	JIC-G105519	28.02
		2PC		P-U-9	1-3/4	3-1/2	JIC-G105518	29.21
				P-U-1	1-3/4		JIC-D42873	13.78
DOZER ANGLE (Angle Tilt Dozer)		2PC		N-N-9		3-1/2	JIC-G33237	12.32
		2PC		N-N-9		3	JIC-G33151	11.12
DOZER LIFT		2PC		P-UB-9	1-1/2	3	JIC-G105512	29.35
		1PC		P-UB-10	1-1/2	3	JIC-G105548	25.60
				P-U-1	1-1/2		JIC-D42870	13.42
		1PC		P-UB-10	1-1/4	2-1/2	JIC-G105551	21.77
DOZER TILT		2PC		P-U-9	1-1/4	2-1/2	JIC-G32295	19.66
		2PC		N-N-9		2-1/2	JIC-G33193	10.85
				P-U-1	1-1/4		JIC-D42867	10.76
		1PC		P-UB-10	1-1/4	2-1/2	JIC-G105551	21.77
	2PC		P-U-9	1-1/4	2-1/2	JIC-G32295	19.66	
			P-U-1	1-1/4		JIC-D42867	10.76	

Replacement Kits For

J.I. CASE

J.I. CASE

Track-Type Dozers/Loaders								
APPLICATION	CYL #	Piston	SERIAL #	CODE	ROD	BORE	KIT #	List \$
MODEL 350 with Backhoe Models 26, 26B, 26C, 26S								
DOZER TILT		2PC		N-N-9		2-1/2	JIC-G33193	10.85
LOADER CLAM		1PC		P-UB-10	1-3/4	3	JIC-G105549	32.58
		2PC		P-UB-9	1-3/4	3	JIC-G105524	32.34
LOADER GRAPPLE		1PC		P-UB-10	1-1/2	2-1/2	JIC-G105550	19.21
		2PC		P-U-9	1-1/2	2-1/2	JIC-G32294	20.22
		2PC		N-N-9		2-1/2	JIC-G33193	10.85
				P-U-1	1-1/2		JIC-D42869	13.52
LOADER HYDRA-LEVELING		2PC		P-U-9	1-1/2	2-1/2	JIC-G32294	20.22
				P-U-1	1-1/2		JIC-D42869	13.52
		1PC		P-UB-10	1-1/2	2-1/2	JIC-G105550	19.21
		2PC		N-N-9		2-1/2	JIC-G33193	10.85
LOADER LIFT		2PC		P-UB-9	1-3/4	3	JIC-G105524	32.34
				P-U-1	1-3/4		JIC-D42872	10.05
		2PC		N-N-9		3	JIC-G33151	11.12
		1PC		P-UB-10	1-3/4	3	JIC-G105549	32.58
		2PC		P-U-9	1-3/4	3	JIC-G34643	25.84
LOADER TILT		1PC		P-UB-10	1-1/2	2-1/2	JIC-G105550	19.21
		2PC		P-U-9	1-1/2	2-1/2	JIC-G32294	20.22
		2PC		N-N-9		2-1/2	JIC-G33193	10.85
				P-U-1	1-1/2		JIC-D42869	13.52
RIPPER		1PC		P-UB-10	1-1/2	3	JIC-G105548	25.60
				P-U-1	1-1/2		JIC-D42870	13.42
		2PC		N-N-9		3	JIC-G33151	11.12
		2PC		P-UB-9	1-1/2	3	JIC-G105512	29.35
MODEL 350B with Backhoe Models 26C, 26D								
BACKHOE BOOM		1PC		P-UB-10	1-3/4	4	JIC-G105552	30.68
		2PC		P-UB-9	2-1/2	4	JIC-G34636	33.71
		1PC		P-UB-10	2-1/4	4	JIC-G105556	33.28
BACKHOE BUCKET		2PC		P-UB-9	1-3/4	3	JIC-G105524	32.34
		1PC		P-UB-10	1-3/4	3	JIC-G105549	32.58
		1PC		P-UB-10	2	3-1/4	JIC-G105553	32.28
BACKHOE DIPPER		2PC		P-UB-9	2	3-1/2	JIC-G105527	32.20
		1PC		P-UB-10	2	3-1/2	JIC-G105546	28.82
BACKHOE DIPPER EXT		1PC		P-UB-10	1-1/2	3	JIC-G105548	25.60
		2PC		P-UB-9	1-1/2	3	JIC-G105512	29.35
BACKHOE STABILIZER		2PC		P-U-9	1-3/4	3-1/2	JIC-G105518	29.21
		1PC		P-UB-10	1-3/4	3	JIC-G105549	32.58
BACKHOE SWING		2PC		P-U-9	1-1/2	3-1/2	JIC-G34652	25.71
		1PC		P-UB-10	1-1/2	3-1/2	JIC-G105555	24.09
DOZER ANGLE		1PC		P-UB-10	1-1/2	3	JIC-G109452	19.44
DOZER LIFT		1PC		P-UB-10	1-1/4	2-1/2	JIC-G109475	21.77
DOZER TILT		1PC		P-UB-10	1-1/4	2-1/2	JIC-G109475	21.77
LOADER CLAM		1PC		P-UB-10	1-3/4	3	JIC-1543262C1	38.59
LOADER LIFT		1PC		P-UB-10	1-3/4	3	JIC-1543262C1	38.59

Replacement Kits For

J.I. CASE

J.I. CASE

Track-Type Dozers/Loaders								
APPLICATION	CYL #	Piston	SERIAL #	CODE	ROD	BORE	KIT #	List \$
MODEL 350B with Backhoe Models 26C, 26D								
LOADER TILT		1PC		P-UB-10	1-1/2	2-1/2	JIC-1543253C1	40.96
RIPPER		1PC		P-UB-10	1-1/2	3	JIC-G109452	19.44
MODEL 420C								
BACKHOE BOOM		2PC		N-N-9		4	JIC-G33239	13.44
				I-U-1	2		JIC-D42876	9.31
BACKHOE BUCKET		2PC		N-N-9		3-1/2	JIC-G33237	12.32
				P-U-1	1-3/4		JIC-D42873	13.78
BACKHOE DIPPER		2PC		N-N-9		4	JIC-G33239	13.44
				I-U-1	2		JIC-D42876	9.31
BACKHOE STABILIZER		2PC		N-N-9		3-1/2	JIC-G33237	12.32
				P-U-1	1-3/4		JIC-D42873	13.78
DOZER ANGLING		2PC		N-N-9		3-1/2	JIC-G33237	12.32
				P-U-1	1-3/4		JIC-D42873	13.78
DOZER LIFT				P-U-1	1-1/4		JIC-D42867	10.76
		2PC		N-N-9		4	JIC-G33239	13.44
DOZER TILT				P-U-1	1-1/4		JIC-D42867	10.76
		2PC		N-N-9		4	JIC-G33239	13.44
LOADER LIFT				P-U-1	1-3/4		JIC-D42873	13.78
		2PC		N-N-9		3-1/2	JIC-G33237	12.32
LOADER TILT		2PC		N-N-9		4	JIC-G33239	13.44
				P-U-1	1-1/4		JIC-D42867	10.76
SCARIFIER		2PC		N-N-9		4	JIC-G33239	13.44
				P-U-1	1-1/2		JIC-D42870	13.42
MODEL 450 with Backhoe Models 26, 26B, 26C, 26S, 32, 33, 35								
BACKHOE BOOM		1PC		P-UB-10	1-3/4	3-1/4	JIC-G105547	29.44
		2PC		P-UB-9	2-1/4	4-1/2	JIC-G105520	47.70
		2PC		P-UB-9	1-3/4	3-1/4	JIC-G105528	28.09
				P-U-1	2-1/4		JIC-D42878	12.24
		1PC		P-UB-10	2-1/4	4	JIC-G105556	33.28
		2PC		N-N-9		3-1/2	JIC-G33237	12.32
				P-U-1	1-3/4		JIC-D42873	13.78
		2PC		P-UB-9	2-1/2	4	JIC-G34636	33.71
		2PC		P-UB-9	2	4	JIC-G105517	29.71
		2PC		P-U-9	2	4	JIC-G32299	29.21
		2PC		N-N-9		4	JIC-G33239	13.44
				I-U-1	2		JIC-D42876	9.31
		2PC		P-UB-9	1-3/4	3-1/2	JIC-G105529	27.40
BACKHOE BUCKET		2PC		N-N-9		4-1/2	JIC-DTVS4.5P	26.62
		2PC		N-N-9		3-1/2	JIC-G33237	12.32
				I-U-1	2		JIC-D42874	9.05
				P-U-1	1-3/4		JIC-D42873	13.78
		1PC		P-UB-10	1-3/4	3	JIC-G105549	32.58
		2PC		P-UB-9	1-3/4	3	JIC-G105524	32.34
		2PC		P-UB-9	2	3-1/2	JIC-G105527	32.20
	1PC		P-UB-10	2	3-1/2	JIC-G105546	28.82	

Replacement Kits For

J.I. CASE

Track-Type Dozers/Loaders

APPLICATION	CYL #	Piston	SERIAL #	CODE	ROD	BORE	KIT #	List \$
MODEL 450 with Backhoe Models 26, 26B, 26C, 26S, 32, 33, 35								
BACKHOE BUCKET				P-U-1	1-3/4		JIC-D42872	10.05
		2PC		P-U-9	2	3-1/2	JIC-G32293	26.40
BACKHOE DIPPER		2PC		P-U-9	2	4	JIC-G32299	29.21
				I-U-1	2		JIC-D42874	9.05
				I-U-1	2		JIC-D42876	9.31
	1PC			P-UB-10	2	3-1/2	JIC-G105546	28.82
	2PC			N-N-9		4	JIC-G33239	13.44
	2PC			N-N-9		3-1/2	JIC-G33237	12.32
	2PC			P-UB-9	2	4	JIC-G105517	29.71
	1PC			P-UB-10	2	4	JIC-1543273C1	52.46
	2PC			P-U-9	2	3-1/2	JIC-G32293	26.40
	2PC			P-UB-9	2	3-1/2	JIC-G105527	32.20
BACKHOE DIPPER EXT	2PC			P-UB-9	1-3/4	3-1/2	JIC-G105529	27.40
	2PC			N-N-9		3-1/2	JIC-G33237	12.32
	2PC			P-U-1	1-3/4		JIC-D42873	13.78
	2PC			P-UB-10	1-1/2	3	JIC-G105548	25.60
	2PC			P-UB-9	1-1/2	3	JIC-G105512	29.35
BACKHOE STABILIZER	2PC			P-UB-9	1-3/4	3-1/2	JIC-G105529	27.40
	2PC			P-U-9	1-3/4	3-1/2	JIC-G105518	29.21
	1PC			P-UB-10	2	4	JIC-1543273C1	52.46
	2PC			N-N-9		3	JIC-G33151	11.12
	2PC			N-N-9		3-1/2	JIC-G33237	12.32
				P-U-1	1-3/4		JIC-D42873	13.78
	2PC			P-UB-9	2	4	JIC-G105517	29.71
	2PC			P-UB-9	1-3/4	3	JIC-G105524	32.34
				P-U-1	1-3/4		JIC-D42872	10.05
				P-U-1	1-1/2		JIC-D42870	13.42
BACKHOE SWING	1PC			P-UB-10	2	4	JIC-1543273C1	52.46
	2PC			P-UB-9	2	4	JIC-G105517	29.71
				P-U-1	1-1/2		JIC-D47896	10.83
	2PC			P-UB-9	1-3/4	4	JIC-G105519	28.02
	2PC			N-N-9		4	JIC-G33239	13.44
				P-U-1	1-3/4		JIC-D42875	10.67
	1PC			P-UB-10	1-1/2	3-1/2	JIC-G105555	24.09
	2PC			N-N-9		3-1/2	JIC-G33237	12.32
	2PC			P-U-9	1-1/2	3-1/2	JIC-G34652	25.71
DOZER ANGLING (Angle Dozer)	2PC			P-UB-9	1-1/2	2	JIC-G105503	24.38
	2PC			I-U-9	1-1/2	2	JIC-D37361	16.85
DOZER ANGLING (Angle Tilt Dozer)				I-U-1	2		JIC-D42876	9.31
	2PC			P-UB-9	2	4	JIC-G105526	30.90
	1PC			P-UB-10	2	4	JIC-1543273C1	52.46
	2PC			N-N-9		4	JIC-G33239	13.44

Replacement Kits For

J.I. CASE

J.I. CASE

Track-Type Dozers/Loaders								
APPLICATION	CYL #	Piston	SERIAL #	CODE	ROD	BORE	KIT #	List \$
MODEL 450 with Backhoe Models 26, 26B, 26C, 26S, 32, 33, 35								
DOZER LIFT				P-U-1	1-1/4		JIC-D42867	10.76
		2PC		N-N-9		2-1/2	JIC-G33193	10.85
		2PC		P-U-9	1-1/4	2-1/2	JIC-G32295	19.66
DOZER TILT				I-U-1	2		JIC-D42874	9.05
		2PC		N-N-9		3-1/2	JIC-G33237	12.32
		2PC		P-UB-9	2	3-1/2	JIC-G105521	28.09
		2PC		P-U-9	2	3-1/2	JIC-G34648	29.78
LOADER CLAM		1PC		P-UB-10	2	3-1/2	JIC-G105546	28.82
				P-U-1	1-1/2		JIC-D42870	13.42
		1PC		P-UB-10	1-1/2	3	JIC-G105548	25.60
		2PC		P-UB-9	1-1/2	3	JIC-G105512	29.35
LOADER HYDRA-LEVELING		2PC		N-N-9		3	JIC-G33151	11.12
		2PC		P-U-1	1-3/4		JIC-D42872	10.05
		2PC		N-N-9		3	JIC-G33151	11.12
		2PC		P-UB-9	1-3/4	3	JIC-G105524	32.34
LOADER LIFT		1PC		P-UB-10	1-3/4	3	JIC-G105549	32.58
		1PC		P-UB-10	2	3-1/2	JIC-G105546	28.82
				I-U-1	2		JIC-D42874	9.05
LOADER TILT		2PC		N-N-9		3-1/2	JIC-G33237	12.32
		2PC		P-U-9	2	3-1/2	JIC-G34648	29.78
		2PC		P-UB-9	2	3-1/2	JIC-G105521	28.09
		1PC		P-UB-10	1-3/4	3	JIC-G105549	32.58
		2PC		N-N-9		3	JIC-G33151	11.12
		2PC		P-UB-9	1-3/4	3	JIC-G105524	32.34
		2PC		P-U-9	1-3/4	3	JIC-G34643	25.84
RIPPER				P-U-1	1-3/4		JIC-D42872	10.05
		2PC		P-UB-9	1-1/2	3	JIC-G105512	29.35
		2PC		N-N-9		3-1/2	JIC-G33237	12.32
		1PC		P-UB-10	1-1/2	3	JIC-G105548	25.60
				P-U-1	1-1/2		JIC-D42870	13.42
MODEL 450B, 450C, 455B, 455C with Backhoe Models 26D, 35								
BACKHOE BOOM		2PC		P-UB-9	1-3/4	3-1/4	JIC-G105528	28.09
		1PC		P-UB-10	1-3/4	4	JIC-G105552	30.68
BACKHOE BUCKET		1PC		P-UB-10	1-3/4	3-1/4	JIC-G105547	29.44
		1PC		P-UB-10	2	3-1/4	JIC-G105553	32.28
		1PC		P-UB-10	2	3-1/2	JIC-G105546	28.82
BACKHOE DIPPER		2PC		P-UB-9	2	3-1/2	JIC-G105527	32.20
		2PC		P-UB-9	2	4	JIC-G105517	29.71
		1PC		P-UB-10	2	3-1/2	JIC-G105546	28.82
BACKHOE DIPPER EXT		1PC		P-UB-10	2	4	JIC-1543273C1	52.46
		2PC		P-UB-9	1-1/2	3	JIC-G105512	29.35
BACKHOE STABILIZER		1PC		P-UB-10	1-1/2	3	JIC-G105548	25.60
		2PC		P-UB-9	2	4	JIC-G105517	29.71
		1PC		P-UB-10	2	4	JIC-1543273C1	52.46

Replacement Kits For

J.I. CASE

J.I. CASE

Track-Type Dozers/Loaders								
APPLICATION	CYL #	Piston	SERIAL #	CODE	ROD	BORE	KIT #	List \$
MODEL 450B, 450C, 455B, 455C with Backhoe Models 26D, 35								
BACKHOE STABILIZER		1PC		P-UB-10	1-3/4	3	JIC-G105549	32.58
BACKHOE SWING		1PC		P-UB-10	1-1/2	3-1/2	JIC-G105555	24.09
		2PC		P-UB-10	2	4	JIC-1543273C1	52.46
		2PC		P-UB-9	2	4	JIC-G105517	29.71
		1PC		P-UB-10	2	4	JIC-1543273C1	52.46
DOZER ANGLE		1PC		P-UB-10	1-1/4	2-1/2	JIC-G105551	21.77
DOZER LIFT		1PC		P-UB-10	2	3-1/2	JIC-G105546	28.82
DOZER TILT		1PC		P-UB-10	1-1/2	3	JIC-G105548	25.60
LOADER CLAM		1PC		P-UB-10	2	4	JIC-1543273C1	52.46
LOADER HYDRA-LEVELING		1PC		P-UB-10	2	3-1/2	JIC-G105546	28.82
LOADER LIFT		1PC		P-UB-10	1-1/2	3	JIC-G105548	25.60
LOADER TILT		1PC		P-UB-10	1-1/2	3	JIC-G105548	25.60
RIPPER		1PC		P-UB-10	1-1/2	3	JIC-G105548	25.60
MODEL 475 Cable Layer								
DOZER TILT		1PC		P-UB-10	2	3-1/2	JIC-G105546	28.82
		2PC		P-U-9	2	3-1/2	JIC-G34648	29.78
PLOW LIFT		2PC		P-UB-9	2	4-1/2	JIC-G105525	38.20
PLOW SWING		2PC		P-U-9	1-1/2	3-1/2	JIC-G34646	25.28
		1PC		P-UB-10	1-1/2	3-1/2	JIC-G105555	24.09
REEL & DOZER LIFT		2PC		P-U-9	1-1/4	2-1/2	JIC-G32295	19.66
		1PC		P-UB-10	1-1/4	2-1/2	JIC-G105551	21.77
MODEL 750 with Backhoe Models 32, 33S, 34								
BACKHOE BOOM		2PC		N-N-9		4	JIC-G33239	13.44
		2PC		P-U-9	2	4	JIC-G32299	29.21
				P-U-1	2-1/4		JIC-D42878	12.24
		2PC		P-UB-9	2-1/4	4-1/2	JIC-G105520	47.70
				I-U-1	2		JIC-D42876	9.31
BACKHOE BUCKET		2PC		N-N-9		4-1/2	JIC-DTVS4.5P	26.62
				I-U-1	2-1/4		JIC-D42877	9.97
				P-U-1	1-3/4		JIC-D42873	13.78
		2PC		N-N-9		3-1/2	JIC-G33237	12.32
		2PC		P-U-9	2	3-1/2	JIC-G32293	26.40
BACKHOE DIPPER		2PC		N-N-9		4	JIC-G33239	13.44
				I-U-1	2		JIC-D42874	9.05
				I-U-1	2		JIC-D42876	9.31
		2PC		N-N-9		4	JIC-G33239	13.44
		2PC		P-U-9	2	4	JIC-G32299	29.21
BACKHOE STABILIZER				P-U-1	2-1/4		JIC-D42878	12.24
		2PC		N-N-9		4-1/2	JIC-DTVS4.5P	26.62
				P-U-1	1-3/4		JIC-D42873	13.78
		2PC		P-UB-9	1-3/4	3-1/2	JIC-G105529	27.40
		2PC		N-N-9		3-1/2	JIC-G33237	12.32
BACKHOE SWING		2PC		N-N-9		4	JIC-G33239	13.44
		2PC		P-UB-9	1-3/4	4	JIC-G105519	28.02
				P-U-1	1-3/4		JIC-D42875	10.67

Replacement Kits For

J.I. CASE

J.I. CASE

Track-Type Dozers/Loaders								
APPLICATION	CYL #	Piston	SERIAL #	CODE	ROD	BORE	KIT #	List \$
MODEL 750 with Backhoe Models 32, 33S, 34								
DOZER ANGLE		2PC		I-U-9	1-1/2	2-1/2	JIC-D37360	18.42
DOZER TILT		2PC		N-N-9		3-1/2	JIC-G33237	12.32
				P-U-1	1-3/4		JIC-D42873	13.78
LOADER LIFT		2PC		N-N-9		3	JIC-G33151	11.12
				P-U-1	1-1/2		JIC-D42870	13.42
LOADER TILT		2PC		N-N-9		4	JIC-G33239	13.44
				I-U-1	2		JIC-D42876	9.31
RIPPER				P-U-1	1-3/4		JIC-D42873	13.78
		2PC		N-N-9		3-1/2	JIC-G33237	12.32
MODEL 850 with Backhoe Models 34, 35, 36								
BACKHOE BOOM		2PC		N-N-9		4-1/2	JIC-DTVS4.5P	26.62
		2PC		P-U-9	2-1/4	5	JIC-G32696	37.64
		2PC		P-UB-9	1-3/4	3-1/4	JIC-G105528	28.09
		1PC		P-UB-10	1-3/4	3-1/4	JIC-G105547	29.44
				P-U-1	2-1/4		JIC-D42878	12.24
BACKHOE BUCKET		2PC		P-UB-9	2-1/2	4	JIC-G34636	33.71
		2PC		P-UB-9	2	3-1/2	JIC-G105527	32.20
		2PC		N-N-9		4	JIC-G33239	13.44
				I-U-1	2-1/4		JIC-D42877	9.97
		1PC		P-UB-10	2	3-1/2	JIC-G105546	28.82
BACKHOE DIPPER		2PC		P-UB-9	2	4	JIC-G105517	29.71
		1PC		P-UB-10	2	4	JIC-1543273C1	52.46
		2PC		P-UB-9	2-1/2	4-1/2	JIC-G105513	49.19
		2PC		P-UB-9	2-1/4	4-1/2	JIC-G105520	47.70
		2PC		N-N-9		4-1/2	JIC-DTVS4.5P	26.62
				P-U-1	2-1/4		JIC-D42878	12.24
BACKHOE DIPPER EXT		2PC		P-UB-9	1-1/2	3	JIC-G105512	29.35
		1PC		P-UB-10	1-1/2	3	JIC-G105548	25.60
BACKHOE STABILIZER		2PC		P-U-9	2	4	JIC-G32299	29.21
		2PC		P-UB-9	2	4	JIC-G105517	29.71
				I-U-1	2		JIC-D42876	9.31
		2PC		N-N-9		4	JIC-G33239	13.44
		1PC		P-UB-10	2	4	JIC-1543273C1	52.46
BACKHOE SWING		2PC		P-UB-9	2	4	JIC-G105517	29.71
		2PC		P-UB-9	2	4-1/2	JIC-G105525	38.20
		1PC		P-UB-10	2	4	JIC-1543273C1	52.46
				P-U-1	1-3/4		JIC-D42875	10.67
		2PC		N-N-9		4	JIC-G33239	13.44
		2PC		P-U-9	2	4-1/2	JIC-G32695	39.33
DOZER ANGLING		2PC		P-UB-9	1-1/2	2-1/2	JIC-G105505	19.89
		2PC		I-U-9	1-1/2	2-1/2	JIC-D37360	18.42
DOZER LIFT		2PC		P-UB-9	1-1/2	3	JIC-G105512	29.35
				P-U-1	1-1/2		JIC-D42870	13.42
		2PC		N-N-9		3	JIC-G33151	11.12
DOZER TILT		2PC		P-U-9	1-3/4	3-1/2	JIC-G105518	29.21

Replacement Kits For

J.I. CASE

J.I. CASE

Track-Type Dozers/Loaders								
APPLICATION	CYL #	Piston	SERIAL #	CODE	ROD	BORE	KIT #	List \$
MODEL 850 with Backhoe Models 34, 35, 36								
DOZER TILT		2PC		N-N-9		3-1/2	JIC-G33237	12.32
				P-U-1	1-3/4		JIC-D42873	13.78
DOZER TILT & PITCH		2PC		P-UB-9	2	3-1/2	JIC-G105521	28.09
LOADER CLAM		2PC		P-U-9	2	4	JIC-G32299	29.21
LOADER HYDRA-LEVELING				I-U-1	2		JIC-D42876	9.31
		2PC		N-N-9		4	JIC-G33239	13.44
		2PC		P-U-9	2	4	JIC-G32299	29.21
		2PC		P-UB-9	2	4	JIC-G105517	29.71
LOADER LIFT		2PC		N-N-9		4-1/2	JIC-DTVS4.5P	26.62
				P-UB-9	2-1/4	4-1/2	JIC-G105520	47.70
				P-U-1	2-1/4		JIC-D42878	12.24
LOADER TILT		2PC		N-N-9		3-1/2	JIC-G33237	12.32
				P-U-1	1-3/4		JIC-D42873	13.78
		2PC		P-U-9	1-3/4	3-1/2	JIC-G32228	26.07
		2PC		P-U-9	1-3/4	3-1/2	JIC-G105508	31.80
RIPPER		2PC		P-U-9	1-3/4	4	JIC-G34626	30.34
				P-U-1	1-3/4		JIC-D42875	10.67
		2PC		N-N-9		4	JIC-G33239	13.44
MODEL 850B with Backhoe Model 35								
BACKHOE BOOM		1PC		P-UB-10	1-3/4	3-1/4	JIC-G105547	29.44
		2PC		P-UB-9	1-3/4	3-1/4	JIC-G105528	28.09
BACKHOE BUCKET		1PC		P-UB-10	2	3-1/2	JIC-G105546	28.82
		2PC		P-UB-9	2	3-1/2	JIC-G105527	32.20
BACKHOE DIPPER		2PC		P-UB-9	2	4	JIC-G105517	29.71
		1PC		P-UB-10	2	4	JIC-1543273C1	52.46
BACKHOE DIPPER EXT		2PC		P-UB-9	1-1/2	3	JIC-G105512	29.35
		1PC		P-UB-10	1-1/2	3	JIC-G105548	25.60
BACKHOE STABILIZER		2PC		P-UB-9	2	4	JIC-G105517	29.71
		1PC		P-UB-10	2	4	JIC-1543273C1	52.46
BACKHOE SWING		2PC		P-UB-9	2	4	JIC-G105517	29.71
		1PC		P-UB-10	2	4	JIC-1543273C1	52.46
DOZER ANGLE		2PC		P-UB-9	2	4-1/2	JIC-G105525	38.20
DOZER LIFT		1PC		P-UB-10	1-1/2	3	JIC-G105548	25.60
		1PC		P-UB-10	1-3/4	3	JIC-G105549	32.58
DOZER TILT		1PC		P-UB-10	2	4	JIC-1543273C1	52.46
		1PC		P-UB-10	1-3/4	4	JIC-G105552	30.68
LOADER CLAM		1PC		P-UB-10	2	3-1/2	JIC-G105546	28.82
LOADER LIFT		1PC		P-UB-10	2	4	JIC-1543273C1	52.46
LOADER TILT		1PC		P-UB-10	2	3-1/2	JIC-G105546	28.82
RIPPER		1PC		P-UB-10	1-3/4	3-1/4	JIC-G105547	29.44
MODEL 850C, 855C with Backhoe Models 35A, 35A, 35C WL, 3								
BACKHOE BOOM		1PC		P-UB-10	1-3/4	3-1/4	JIC-G105547	29.44
BACKHOE BUCKET		1PC		P-UB-10	2	3-1/2	JIC-G105546	28.82
		1PC		P-UB-10	2-1/2	3-1/2	JIC-G109504	28.46

Replacement Kits For

J.I. CASE

J.I. CASE

Track-Type Dozers/Loaders								
APPLICATION	CYL #	Piston	SERIAL #	CODE	ROD	BORE	KIT #	List \$
MODEL 850C, 855C with Backhoe Models 35A, 35A, 35C WL, 3								
BACKHOE BUCKET		1PC		P-UB-10	2-1/2	4	JIC-G109424	33.66
BACKHOE DIPPER		1PC		P-UB-10	2	4	JIC-1543273C1	52.46
BACKHOE DIPPER EXT		1PC		P-UB-10	1-1/2	3	JIC-G105548	25.60
BACKHOE STABILIZER		1PC		P-UB-10	2	4	JIC-1543273C1	52.46
BACKHOE SWING		1PC		P-UB-10	2	4	JIC-1543273C1	52.46
DOZER ANGLE		2PC		P-UB-9	2	4-1/2	JIC-G105525	38.20
DOZER LIFT		1PC		P-UB-10	1-3/4	3	JIC-G105549	32.58
		1PC		P-UB-10	1-1/2	3	JIC-G105548	25.60
DOZER TILT				P-UB-10	1-3/4	4	JIC-G105552	30.68
		1PC		P-UB-10	2	4	JIC-1543273C1	52.46
LOADER CLAM		1PC		P-UB-10	2	3-1/2	JIC-G105546	28.82
LOADER LIFT		1PC		P-UB-10	2	4	JIC-1543273C1	52.46
LOADER TILT		1PC		P-UB-10	2	3-1/2	JIC-G105546	28.82
RIPPER		1PC		P-UB-10	1-3/4	3-1/4	JIC-G105547	29.44
MODEL 850D with Backhoe Models 35C, 35C WL								
BACKHOE BOOM		1PC		P-UB-10	1-3/4	3-1/4	JIC-1543265C1	47.82
BACKHOE BUCKET		1PC		P-UB-10	2-1/2	3-1/2	JIC-G109504	28.46
		1PC		P-UB-10	2-1/2	4	JIC-G109424	33.66
BACKHOE DIPPER		1PC		P-UB-10	2	4	JIC-1543273C1	52.46
BACKHOE DIPPER EXT		1PC		P-UB-10	1-1/2	3	JIC-G109452	19.44
BACKHOE STABILIZER		1PC		P-UB-10	2	4	JIC-1543273C1	52.46
BACKHOE SWING		1PC		P-UB-10	2	4	JIC-1543273C1	52.46
DOZER LIFT		1PC		P-UB-10	1-1/2	3	JIC-G109452	19.44
DOZER TILT		1PC		P-UB-10	2	4	JIC-1543273C1	52.46
LOADER CLAM		1PC		P-UB-10	2	3-1/2	JIC-G109453	28.82
LOADER LIFT		1PC		P-UB-10	2	4	JIC-1543273C1	52.46
LOADER TILT		1PC		P-UB-10	2	3-1/2	JIC-G109453	28.82
RIPPER		1PC		P-UB-10	1-3/4	3-1/4	JIC-1543265C1	47.82
MODEL 1150 with Backhoe Models 32, 34, 36								
BACKHOE BOOM				P-U-1	2-1/4		JIC-D42878	12.24
				I-U-1	2		JIC-D42876	9.31
		2PC		P-U-9	2-1/4	5	JIC-G32696	37.64
		2PC		N-N-9		4-1/2	JIC-DTVS4.5P	26.62
		2PC		N-N-9		4	JIC-G33239	13.44
BACKHOE BUCKET		2PC		N-N-9		4	JIC-G33239	13.44
		2PC		P-UB-9	2-1/2	4	JIC-G34636	33.71
				I-U-1	2-1/4		JIC-D42877	9.97
		2PC		N-N-9		3-1/2	JIC-G33237	12.32
				P-U-1	1-3/4		JIC-D42873	13.78
BACKHOE DIPPER				P-U-1	2-1/4		JIC-D42878	12.24
		2PC		P-UB-9	2-1/2	4-1/2	JIC-G105513	49.19
				I-U-1	2		JIC-D42876	9.31
		2PC		N-N-9		4-1/2	JIC-DTVS4.5P	26.62
		2PC		N-N-9		4	JIC-G33239	13.44
		2PC		P-UB-9	2-1/4	4-1/2	JIC-G105520	47.70

Replacement Kits For

J.I. CASE**Track-Type Dozers/Loaders**

APPLICATION	CYL #	Piston	SERIAL #	CODE	ROD	BORE	KIT #	List \$
MODEL 1150 with Backhoe Models 32, 34, 36								
BACKHOE STABILIZER				P-U-1	1-3/4		JIC-D42873	13.78
		2PC		N-N-9		3-1/2	JIC-G33237	12.32
				I-U-1	2		JIC-D42876	9.31
		2PC		N-N-9		4	JIC-G33239	13.44
		2PC		P-U-9	2	4	JIC-G32299	29.21
		2PC		P-UB-9	2	4	JIC-G105517	29.71
BACKHOE SWING				P-U-1	1-3/4		JIC-D42875	10.67
		2PC		N-N-9		4	JIC-G33239	13.44
		2PC		P-U-9	2	4-1/2	JIC-G32695	39.33
		2PC		P-UB-9	2	4-1/2	JIC-G105525	38.20
DOZER LIFT		2PC		N-N-9		3-1/2	JIC-G33237	12.32
		2PC		P-UB-9	1-3/4	3-1/2	JIC-G105529	27.40
DOZER TILT				P-U-1	1-3/4		JIC-D42873	13.78
		2PC		P-U-9	1-3/4	3-1/2	JIC-G105508	31.80
		2PC		P-U-9	1-3/4	3-1/2	JIC-G105518	29.21
		2PC		P-U-9	1-3/4	3-1/2	JIC-G105518	29.21
				P-U-1	1-3/4		JIC-D42873	13.78
		2PC		N-N-9		3-1/2	JIC-G33237	12.32
LOADER CLAM		2PC		N-N-9		4	JIC-G33239	13.44
				I-U-1	2		JIC-D42876	9.31
LOADER LIFT		2PC		P-U-9	2	4	JIC-G32299	29.21
		2PC		P-UB-9	2-1/4	4-1/2	JIC-G105520	47.70
LOADER TILT		2PC		P-U-9	2-1/2	5-1/2	JIC-G33823	35.71
PIPPER		2PC		P-U-9	2-1/4	5	JIC-G32696	37.64
		2PC		P-UB-9	2	4	JIC-G105517	29.71
				I-U-1	2		JIC-D42876	9.31
		2PC		N-N-9		4	JIC-G33239	13.44
	2PC		P-UB-9	2	4	JIC-G105526	30.90	
MODEL 1150B								
DOZER ANGLE		2PC		P-U-9	1-3/4	3	JIC-G34643	25.84
		1PC		P-UB-10	1-3/4	3	JIC-G105549	32.58
		2PC		P-UB-9	1-3/4	3	JIC-G105523	28.09
DOZER TILT		2PC		P-UB-9	2-1/4	4-1/2	JIC-G105520	47.70
DOZER TILT & PITCH		2PC		P-UB-9	2-1/2	4	JIC-G34636	33.71
		1PC		P-UB-10	2-1/4	4	JIC-G105556	33.28
FELLER BUNCHER		2PC		P-UB-9	2-1/4	4-1/2	JIC-G105520	47.70
LOADER CLAM		2PC		P-UB-9	2-1/4	4-1/2	JIC-G105520	47.70
LOADER LIFT		2PC		P-U-9	2-1/4	5	JIC-G32696	37.64
		2PC		P-UB-9	2-1/4	5	JIC-G105530	47.75
LOADER TILT		2PC		P-UB-9	2-1/4	4-1/2	JIC-G105520	47.70
RIPPER		1PC		P-UB-10	2	4	JIC-1543273C1	52.46
		2PC		P-UB-9	2	4	JIC-G105526	30.90
MODEL 1150C, 1150D, 1155D								
DOZER ANGLE		1PC		P-UB-10	1-3/4	3	JIC-1543262C1	38.59
DOZER LIFT		1PC		P-UB-10	1-3/4	3-1/2	JIC-G109471	28.09

Replacement Kits For

J.I. CASE

J.I. CASE

Track-Type Dozers/Loaders								
APPLICATION	CYL #	Piston	SERIAL #	CODE	ROD	BORE	KIT #	List \$
MODEL 1150C, 1150D, 1155D								
DOZER TILT		2PC		P-UB-9	2-1/4	4-1/2	JIC-G105520	47.70
DOZER TILT & PITCH		1PC		P-UB-10	2-1/4	4	JIC-G109505	30.56
LOADER CLAM		2PC		P-UB-9	2-1/4	4-1/2	JIC-G105520	47.70
LOADER LIFT		2PC		P-UB-9	2-1/4	5	JIC-G109501	44.18
LOADER TILT		2PC		P-UB-9	2-1/4	4-1/2	JIC-G105520	47.70
RIPPER		1PC		P-UB-10	2	4	JIC-1543273C1	52.46
MODEL 1450								
DOZER ANGLE		1PC		P-UB-10	2	4	JIC-1543273C1	52.46
DOZER LIFT		2PC		P-UB-9	2	4	JIC-G105517	29.71
		1PC		P-UB-10	2	4	JIC-1543273C1	52.46
DOZER TILT		2PC		P-UB-9	3	6	JIC-G105516	49.50
DOZER TILT & PITCH		2PC		P-UB-9	2-1/2	5	JIC-G105515	40.25
LOADER CLAM		2PC		P-UB-9	2-1/4	4-1/2	JIC-G105520	47.70
LOADER LIFT		2PC		P-UB-9	2-1/2	5-1/2	JIC-G105514	42.50
LOADER TILT		2PC		P-UB-9	2-1/2	5	JIC-G105515	40.25
RIPPER		2PC		P-UB-9	2	4	JIC-G105526	30.90
		1PC		P-UB-10	2	4	JIC-1543273C1	52.46
MODEL 1450B, 1455B								
DOZER ANGLE		1PC		P-UB-10	2-1/4	4	JIC-G105556	33.28
DOZER LIFT		1PC		P-UB-10	2	4	JIC-1543273C1	52.46
DOZER TILT		2PC		P-UB-9	3	6	JIC-G105516	49.50
DOZER TILT & PITCH		2PC		P-UB-9	2-1/2	5	JIC-G105515	40.25
LOADER CLAM		2PC		P-UB-9	2-1/4	4-1/2	JIC-G105520	47.70
LOADER LIFT		2PC		P-UB-9	2-1/2	5-1/2	JIC-G105514	42.50
LOADER TILT		2PC		P-UB-9	2-1/2	5	JIC-G105515	40.25
RIPPER		1PC		P-UB-10	2	4	JIC-1543273C1	52.46
Uni-Loaders								
APPLICATION	CYL #	Piston	SERIAL #	CODE	ROD	BORE	KIT #	List \$
MODEL 1530B								
BUCKET		1PC		P-UB-10	1-1/2	3	JIC-G105502	24.86
BUCKET CLAM		1PC		P-UB-10	1-1/2	3	JIC-G105502	24.86
GRAPPLE		1PC		P-U-10	1	2	JIC-D61006	5.06
LIFT		1PC	-->9818250	P-UB-10	1-1/2	3	JIC-G105502	24.86
		1PC	9818251-UP	P-UB-10	1-1/2	2-1/2	JIC-G109458	15.37
SCARIFIER		1PC		P-UB-10	1-1/2	3	JIC-G105502	24.86
WOOD TICK		1PC		P-UB-10	1-1/2	3	JIC-G105502	24.86
MODEL 1700								
BUCKET		1PC		P-UB-10	1-1/2	3	JIC-G105502	24.86
BUCKET CLAM		1PC		P-UB-10	1-1/2	3	JIC-G105502	24.86
GRAPPLE		1PC		P-U-10	1	2	JIC-D61006	5.06
LIFT		1PC		P-UB-10	1-1/2	3	JIC-G105502	24.86
SCARIFIER		1PC		P-UB-10	1-1/2	3	JIC-G105502	24.86
WOOD TICK		1PC		P-UB-10	1-1/2	3	JIC-G105502	24.86
MODEL 1816B, 1816C								
BUCKET		1PC		P-U-10	1	2	JIC-D61006	5.06

Replacement Kits For

J.I. CASE**J.I. CASE**

Uni-Loaders								
APPLICATION	CYL #	Piston	SERIAL #	CODE	ROD	BORE	KIT #	List \$
MODEL 1816B, 1816C								
GRAPPLE		1PC		P-U-10	1	2	JIC-D61006	5.06
LIFT		1PC		P-U-10	1	2	JIC-D61006	5.06
MODEL 1830								
BUCKET		1PC		P-U-10	1-1/4	2-1/8	JIC-G105507	17.28
		1PC		P-U-10	1	2-1/2	JIC-G35378	15.13
		1PC		P-U-10	1	2-1/2	JIC-G34807	15.68
GRAPPLE		1PC		P-U-10	1	2	JIC-D61006	5.06
LIFT		1PC		P-U-10	1-1/4	2-1/8	JIC-G34819	22.48
SCARIFIER		1PC		P-UB-10	1-1/2	3	JIC-G105502	24.86
MODEL 1835, 1835B								
BUCKET		1PC		P-UB-10	1-1/4	2-1/2	JIC-G109476	20.94
GRAPPLE		1PC		P-U-10	1	2	JIC-D61006	5.06
LIFT		1PC		P-U-10	1-1/4	2-1/8	JIC-G34819	22.48
		1PC		P-UB-10	1-1/2	2-1/2	JIC-G109458	15.37
MODEL 1845, 1845B, 1845C, 1845S								
BUCKET		1PC		P-UB-10	1-1/4	2-1/2	JIC-G109476	20.94
CLAM		1PC		P-UB-10	1-1/2	3	JIC-G109418	19.31
LIFT		1PC		P-UB-10	1-1/2	2-1/2	JIC-G109458	15.37
SCARIFIER		1PC		P-UB-10	1-1/2	3	JIC-G109418	19.31
Unimogs								
APPLICATION	CYL #	Piston	SERIAL #	CODE	ROD	BORE	KIT #	List \$
MODEL MB4/94 with Model 26C Backhoe, P80 Cable Plow, T70								
3-PT HITCH LIFT		2PC		P-UB-9	1-1/2	3	JIC-G105512	29.35
		1PC		P-UB-10	1-1/2	3	JIC-G105548	25.60
3-PT HITCH PITCH		1PC		P-U-10	1-1/4	2-1/8	JIC-G105507	17.28
BACKHOE BOOM		2PC		P-UB-9	2-1/2	4	JIC-G34636	33.71
		1PC		P-UB-10	2-1/4	4	JIC-G105556	33.28
BACKHOE BUCKET		1PC		P-UB-10	1-3/4	3	JIC-G105549	32.58
		2PC		P-UB-9	1-3/4	3	JIC-G105524	32.34
BACKHOE DIPPER		2PC		P-UB-9	2	3-1/2	JIC-G105527	32.20
		1PC		P-UB-10	2	3-1/2	JIC-G105546	28.82
BACKHOE DIPPER EXT		2PC		P-UB-9	1-1/2	3	JIC-G105512	29.35
		1PC		P-UB-10	1-1/2	3	JIC-G105548	25.60
BACKHOE STABILIZER		1PC		P-UB-10	1-3/4	3	JIC-G105549	32.58
		2PC		P-U-9	1-3/4	3-1/2	JIC-G105518	29.21
BACKHOE SWING		2PC		P-UB-9	1-3/4	3	JIC-G105524	32.34
		2PC		P-U-9	1-1/2	3-1/2	JIC-G34652	25.71
		1PC		P-UB-10	1-1/2	3-1/2	JIC-G105555	24.09
CABLE PLOW SHIFT		1PC		P-UB-10	1-1/2	2-1/2	JIC-G105550	19.21
FORKLIFT MAST TILT		1PC		P-UB-10	1-1/4	3	JIC-G105510	17.67
LIFT		2PC		P-UB-9	1-3/4	3	JIC-G105524	32.34
TILT		1PC		P-UB-10	1-1/2	3	JIC-G105502	24.86
		2PC		P-U-9	1-1/2	3-1/2	JIC-G34646	25.28

Replacement Kits For

J.I. CASE

J.I. CASE

Wheel Loaders - 21-Series								
APPLICATION	CYL #	Piston	SERIAL #	CODE	ROD	BORE	KIT #	List \$
MODEL 621								
LOADER CLAM	S300146	1PC	-->JAK0021701	I-U-10	2	4	JIC-S300163	22.00
	S301479	1PC	JAK0021701-UP	I-U-10	2	4	JIC-S301442	33.43
LOADER LIFT	134596C1		JAK0021701-UP	P-UB-10	3	5	JIC-1543305C1	58.31
	G110354	1PC	JAK0021700-UP	P-UB-10	3	5	JIC-1543305C1	58.31
	G110355	1PC	-->JAK0021700	P-UB-10	3	5	JIC-1543305C1	58.31
LOADER TILT	1343552C2	1PC	JAK0020901-UP	P-UB-10	3	6	JIC-G110526	59.23
	1980354C1		JAK0020286- JAK0020900	P-UB-10	3	6	JIC-G110526	59.23
	G110312	1PC	-->JAK0020286	P-UB-10	3	6	JIC-G110526	59.23
STEERING	1976862C1	1PC	ALL	P-UB-10	1-3/4	3	JIC-G110049	25.23
MODEL 621B								
LOADER CLAM	S301431	1PC		I-U-10	2	4	JIC-S301442	33.43
LOADER LIFT	1343595C1			P-UB-10	3	5	JIC-1543305C1	58.31
	1343596C1	1PC		P-UB-10	3	5	JIC-1543305C1	58.31
LOADER TILT, XT LOADER	112551A1	1PC		P-UB-10	2-1/4	4-1/2	JIC-1543279C1	37.07
LOADER TILT, Z-BAR	1343552C2	1PC		P-UB-10	3	6	JIC-G110526	59.23
STEERING	1976862C1	1PC		P-UB-10	1-3/4	3	JIC-1543267C1	46.74
MODEL 721								
LOADER CLAM	S300146	1PC		I-U-10	2	4	JIC-S300163	22.00
	S301431			I-U-10	2	4	JIC-S301442	33.43
	S301479	1PC		I-U-10	2	4	JIC-S301442	33.43
LOADER LIFT	1343595C1			P-UB-10	3	5	JIC-1543305C1	58.31
	1343596C1			P-UB-10	3	5	JIC-1543305C1	58.31
	G110354	1PC		P-UB-10	3	5	JIC-1543305C1	58.31
LOADER TILT	G110355			P-UB-10	3	5	JIC-1543305C1	58.31
	1345991C1	1PC	JAK0022102- JAK0022217	P-UB-10	3	6-1/2	JIC-1543303C1	97.72
	1980347C4	1PC	JAK002218-UP	P-UB-10	3	6-1/2	JIC-1543303C1	97.72
STEERING	1976862C1	1PC		P-UB-10	1-3/4	3	JIC-G110049	25.23
MODEL 721B								
LOADER CLAM	S301431	1PC		I-U-10	2	4	JIC-S301442	33.43
LOADER LIFT	1343595C1	1PC		P-UB-10	3	5	JIC-1543305C1	58.31
	1343596C1	1PC		P-UB-10	3	5	JIC-1543305C1	58.31
LOADER TILT, XT LOADER	112551A1	1PC		P-UB-10	2-1/4	4-1/2	JIC-1543279C1	37.07
LOADER TILT, Z-BAR	1980347C4	1PC		P-UB-10	3	6-1/2	JIC-1543303C1	97.72
STEERING	1976862C1	1PC		P-UB-10	1-3/4	3	JIC-1543267C1	46.74
MODEL 821								
LOADER CLAM	S301000	1PC		I-U-10	2-1/2	5	JIC-S301013	52.46
LOADER LIFT	1340743C3	1PC		P-UB-10	3	6	JIC-G110526	59.23
	1986601C1	1PC		P-UB-10	3-1/2	6	JIC-1986823C2	97.52
LOADER TILT	1980385C3	1PC		P-UB-10	3-1/2	7	JIC-1543309C1	102.09
STEERING	1986978C1		JAK0024132-UP	P-UB-10	1-3/4	3-1/2	JIC-G110621	26.27
	1994558C1	1PC	JAK0024132	P-UB-10	1-3/4	3-1/2	JIC-G110621	26.27

Replacement Kits For

J.I. CASE

J.I. CASE
Wheel Loaders - 21-Series

APPLICATION	CYL #	Piston	SERIAL #	CODE	ROD	BORE	KIT #	List \$
MODEL 821B								
LOADER CLAM	S301000	1PC		I-U-10	2-1/2	5	JIC-S301013	52.46
LOADER LIFT	1986601C1	1PC		P-UB-10	3-1/2	6	JIC-1986823C2	97.52
LOADER TILT	1980386C3	1PC		P-UB-10	3-1/2	7	JIC-1543309C1	102.09
STEERING	1986978C1	1PC		P-UB-10	1-3/4	3-1/2	JIC-1543266C1	47.58
MODEL 921								
LOADER LIFT	1986603C1	1PC		P-UB-10	4	7	JIC-1986920C2	112.36
LOADER TILT	1346171C3	1PC		P-UB-10	4	8	JIC-1346357C2	212.49
STEERING	1346169C2	1PC	1346267C1 & 1346268C1	P-UB-10	2	4	JIC-1543269C1	47.99
	1346169C2	1PC	1346269C1 Gland	P-UB-10	2	4	JIC-1543269C1	47.99

Wheel Loaders - W-Series

APPLICATION	CYL #	Piston	SERIAL #	CODE	ROD	BORE	KIT #	List \$
MODEL W3								
BACKHOE BOOM				I-U-1	2		JIC-D42876	9.31
		2PC		N-N-9		4	JIC-G33239	13.44
BACKHOE BUCKET		2PC		N-N-9		3-1/2	JIC-G33237	12.32
				P-U-1	1-3/4		JIC-D42873	13.78
BACKHOE DIPPER		2PC		N-N-9		4	JIC-G33239	13.44
				I-U-1	2		JIC-D42876	9.31
BACKHOE STABILIZER		2PC		N-N-9		3-1/2	JIC-G33237	12.32
				P-U-1	1-3/4		JIC-D42873	13.78
LOADER LIFT				P-U-1	1-1/2		JIC-D42870	13.42
		2PC		N-N-9		3	JIC-G33151	11.12
LOADER TILT				P-U-1	1-1/2		JIC-D42869	13.52
		2PC		N-N-9		2-1/2	JIC-G33193	10.85
MODEL W7, W7C, W7E								
BACKHOE BOOM				I-U-1	2		JIC-D42876	9.31
		2PC		N-N-9		3	JIC-G33151	11.12
				P-U-1	2-1/4		JIC-D42878	12.24
		2PC		P-UB-9	2-1/4	4-1/2	JIC-G105520	47.70
		2PC		P-U-9	2	4	JIC-G32299	29.21
BACKHOE BUCKET		2PC		N-N-9		4-1/2	JIC-DTVS4.5P	26.62
				P-U-1	1-3/4		JIC-D42873	13.78
				I-U-1	2		JIC-D42874	9.05
		2PC		N-N-9		3-1/2	JIC-G33237	12.32
				I-U-1	2-1/4		JIC-D42877	9.97
		2PC		N-N-9		4	JIC-G33239	13.44
		2PC		P-U-9	2	3-1/2	JIC-G32293	26.40
		2PC		P-UB-9	2-1/2	4	JIC-G34636	33.71
BACKHOE DIPPER				P-U-1	2-1/4		JIC-D42878	12.24
				I-U-1	2		JIC-D42876	9.31
		2PC		P-U-9	2	4	JIC-G32299	29.21
		2PC		N-N-9		4-1/2	JIC-DTVS4.5P	26.62
		2PC		P-UB-9	2-1/4	4-1/2	JIC-G105520	47.70
		2PC		N-N-9		4	JIC-G33239	13.44

Replacement Kits For

J.I. CASE

J.I. CASE

Wheel Loaders - W-Series								
APPLICATION	CYL #	Piston	SERIAL #	CODE	ROD	BORE	KIT #	List \$
MODEL W7, W7C, W7E								
BACKHOE STABILIZER		2PC		N-N-9		3-1/2	JIC-G33237	12.32
				P-U-1	1-3/4		JIC-D42873	13.78
		2PC		P-U-9	1-3/4	3-1/2	JIC-G105518	29.21
		2PC		P-UB-9	1-3/4	3-1/2	JIC-G105529	27.40
				I-U-1	2		JIC-D42876	9.31
		2PC		N-N-9		4	JIC-G33239	13.44
		2PC		P-U-9	2	4	JIC-G32299	29.21
BACKHOE SWING				P-U-1	1-3/4		JIC-D42875	10.67
		2PC		N-N-9		4	JIC-G33239	13.44
		2PC		P-UB-9	1-3/4	4	JIC-G105519	28.02
LOADER LIFT				I-U-1	2		JIC-D42876	9.31
		2PC		P-U-9	2	4	JIC-G32299	29.21
		2PC		N-N-9		4	JIC-G33239	13.44
LOADER TILT		2PC		P-UB-9	1-1/2	3	JIC-G105512	29.35
MODEL W8E								
LOADER LIFT		2PC		P-U-9	2-1/2	5	JIC-G32184	34.45
LOADER TILT		2PC		P-U-9	1-3/4	3-1/2	JIC-G32228	26.07
MODEL W9, W9A, W9B, W9C, W9E, W10, W10B, W10C, W10E								
BACKHOE BOOM				I-U-1	2		JIC-D42876	9.31
		2PC		N-N-9		4	JIC-G33239	13.44
		2PC		P-U-9	2	4	JIC-G32299	29.21
BACKHOE BUCKET				P-U-1	2-1/4		JIC-D42878	12.24
		2PC		N-N-9		4-1/2	JIC-DTVS4.5P	26.62
		2PC		P-UB-9	2-1/4	4-1/2	JIC-G105520	47.70
		2PC		P-U-9	2	3-1/2	JIC-G32293	26.40
				P-U-1	1-3/4		JIC-D42873	13.78
		2PC		N-N-9		3-1/2	JIC-G33237	12.32
				I-U-1	2-1/4		JIC-D42877	9.97
BACKHOE DIPPER		2PC		N-N-9		4	JIC-G33239	13.44
		2PC		P-UB-9	2-1/2	4	JIC-G34636	33.71
				I-U-1	2		JIC-D42874	9.05
				I-U-1	2		JIC-D42876	9.31
		2PC		N-N-9		4	JIC-G33239	13.44
BACKHOE STABILIZER		2PC		P-U-9	2	4	JIC-G32299	29.21
				P-U-1	2-1/4		JIC-D42878	12.24
		2PC		N-N-9		4-1/2	JIC-DTVS4.5P	26.62
		2PC		P-UB-9	2-1/4	4-1/2	JIC-G105520	47.70
		2PC		P-UB-9	1-3/4	3-1/2	JIC-G105529	27.40
				I-U-1	2		JIC-D42876	9.31
		2PC		N-N-9		3-1/2	JIC-G33237	12.32
BACKHOE SWING				P-U-1	1-3/4		JIC-D42873	13.78
		2PC		P-U-9	1-3/4	3-1/2	JIC-G105518	29.21
		2PC		P-U-9	2	4	JIC-G32299	29.21
		2PC		N-N-9		4	JIC-G33239	13.44
				P-U-1	1-3/4		JIC-D42875	10.67

Replacement Kits For

J.I. CASE

J.I. CASE

Wheel Loaders - W-Series								
APPLICATION	CYL #	Piston	SERIAL #	CODE	ROD	BORE	KIT #	List \$
MODEL W9, W9A, W9B, W9C, W9E, W10, W10B, W10C, W10E								
BACKHOE SWING		2PC		N-N-9		4	JIC-G33239	13.44
		2PC		P-UB-9	1-3/4	4	JIC-G105519	28.02
LOADER LIFT		2PC		P-U-9	2-1/2	5	JIC-G32184	34.45
LOADER TILT		2PC		P-U-9	1-3/4	3-1/2	JIC-G32228	26.07
MODEL W11, W11B								
LOADER CLAM		1PC		P-UB-10	1-3/4	3	JIC-1543262C1	38.59
LOADER LIFT		1PC		P-UB-10	2	3-1/2	JIC-G109453	28.82
LOADER TILT		1PC		P-UB-10	1-1/2	2-1/2	JIC-1543253C1	40.96
STEERING		1PC		P-UB-10	1-1/2	3	JIC-G109452	19.44
MODEL W14, W14L, W14H								
BACKHOE BOOM		1PC		P-UB-10	1-3/4	3-1/4	JIC-1543265C1	47.82
		2PC		P-UB-9	2-1/2	4	JIC-G34636	33.71
		2PC		P-UB-9	1-3/4	3-1/4	JIC-G105528	28.09
BACKHOE BUCKET		1PC		P-UB-10	2-1/4	4	JIC-G109505	30.56
		1PC		P-UB-10	1-3/4	3	JIC-1543262C1	38.59
		2PC		P-UB-10	1-1/2	3	JIC-G109452	19.44
		1PC		P-UB-10	2	3-1/2	JIC-G109453	28.82
		1PC		P-UB-10	2-1/2	3-1/2	JIC-G109504	28.46
BACKHOE DIPPER		1PC		P-UB-10	2-1/2	4	JIC-G109424	33.66
		2PC		P-UB-9	1-3/4	3	JIC-G109462	20.09
		2PC		P-UB-9	2	3-1/2	JIC-G109454	21.40
		1PC		P-UB-10	2	3-1/2	JIC-G109453	28.82
		2PC		P-UB-9	2	3-1/2	JIC-G109454	21.40
		1PC		P-UB-10	2	4	JIC-1543273C1	52.46
		2PC		P-UB-9	2	4	JIC-G109421	22.54
BACKHOE DIPPER EXT		1PC		P-UB-10	1-1/2	3	JIC-G109452	19.44
		2PC		P-UB-9	1-1/2	3	JIC-G105512	29.35
BACKHOE STABILIZER		2PC		P-UB-9	1-3/4	3-1/2	JIC-G109470	25.25
		1PC		P-UB-10	1-3/4	3-1/2	JIC-G109471	28.09
		1PC		P-UB-10	2	4	JIC-1543273C1	52.46
BACKHOE SWING		2PC		P-UB-9	2	4	JIC-G109421	22.54
		2PC		P-UB-9	2	4	JIC-G109421	22.54
		1PC		P-UB-10	1-1/2	3-1/2	JIC-G109472	26.56
		1PC		P-UB-10	2	4	JIC-1543273C1	52.46
LOADER CLAM		2PC		P-U-9	1-1/2	3-1/2	JIC-G34652	25.71
		2PC		P-UB-9	1-1/2	3	JIC-G105512	29.35
		1PC		P-UB-10	1-1/2	3	JIC-G109452	19.44
LOADER GRAPPLE		1PC		P-UB-10	1-1/2	3	JIC-G109418	19.31
LOADER LIFT		2PC		P-UB-9	2-1/4	4-1/2	JIC-G105520	47.70
LOADER TILT		1PC		P-UB-10	1-3/4	3	JIC-1543262C1	38.59
		2PC		P-UB-9	1-3/4	3	JIC-G109462	20.09
STEERING		2PC		P-U-9	1-1/4	2-1/2	JIC-G32295	19.66
		1PC		P-UB-10	1-1/4	2-1/2	JIC-G109475	21.77
MODEL W14B								
LOADER CLAM		1PC		P-UB-10	1-1/2	3	JIC-G109452	19.44

Replacement Kits For

J.I. CASE

J.I. CASE

Wheel Loaders - W-Series								
APPLICATION	CYL #	Piston	SERIAL #	CODE	ROD	BORE	KIT #	List \$
MODEL W14B								
LOADER GRAPPLE		1PC		P-UB-10	1-1/2	3	JIC-G109418	19.31
LOADER LIFT		2PC		P-UB-9	2-1/4	4-1/2	JIC-G105520	47.70
LOADER TILT		1PC		P-UB-10	2	3-1/2	JIC-G109453	28.82
STEERING		1PC		P-UB-10	1-1/4	2-1/2	JIC-G109475	21.77
MODEL W18, W20, W20B								
LOADER CLAM		2PC		P-U-9	2	4	JIC-G32299	29.21
		1PC		P-UB-10	2	4	JIC-1543273C1	52.46
LOADER LIFT		2PC	-->9115602	P-U-9	3	5	JIC-G32668	39.82
		2PC	9115603-9123139	P-U-9	3	5	JIC-G109502	45.44
		2PC	9123140-UP	P-UB-9	2-1/2	5	JIC-G105515	40.25
LOADER TILT		2PC		P-UB-9	2	4	JIC-G109421	22.54
		1PC		P-UB-10	2	4	JIC-1543273C1	52.46
STEERING		2PC		P-UB-9	1-1/2	3	JIC-G105512	29.35
		1PC		P-UB-10	1-1/2	3	JIC-G109452	19.44
MODEL W18B, W20C								
LOADER LIFT		2PC	ALL	P-UB-9	2-1/2	5	JIC-G105515	40.25
LOADER TILT		1PC		P-UB-10	2	4	JIC-1543273C1	52.46
STEERING		1PC		P-UB-10	1-1/2	3	JIC-G109452	19.44
MODEL W24								
LOADER CLAM				I-U-1	2		JIC-D42876	9.31
		2PC		N-N-9		4	JIC-G33239	13.44
		2PC		P-U-9	2	4	JIC-G32299	29.21
LOADER LIFT		2PC		P-U-9	3	5	JIC-G32668	39.82
LOADER TILT		2PC		P-UB-9	2-1/2	4-1/2	JIC-G105513	49.19
STEERING		2PC		N-N-9		3	JIC-G33151	11.12
			-->9105108	P-U-1	1-1/2		JIC-D42870	13.42
		2PC	9105109-UP	P-UB-9	1-1/2	3	JIC-G105512	29.35
MODEL W24B								
LOADER CLAM		1PC		P-UB-10	2	4	JIC-1543273C1	52.46
		2PC		P-U-9	2	4	JIC-G34335	27.53
		2PC		P-U-9	2	4	JIC-G32299	29.21
LOADER LIFT		2PC		P-U-9	3	5	JIC-G32668	39.82
		2PC		P-U-9	3	5	JIC-G34334	49.10
		2PC		P-UB-9	3	5	JIC-G105531	46.07
LOADER TILT		2PC		P-UB-9	2-1/2	4-1/2	JIC-G105513	49.19
STEERING		1PC		P-UB-10	1-1/2	3	JIC-G105548	25.60
		2PC		P-UB-9	1-1/2	3	JIC-G105512	29.35
MODEL W24C								
LOADER CLAM		1PC		P-UB-10	2	4	JIC-1543273C1	52.46
LOADER LIFT		2PC		P-UB-9	3	5	JIC-G105531	46.07
LOADER TILT		2PC		P-UB-9	2-1/2	4-1/2	JIC-G105513	49.19
STEERING		1PC		P-UB-10	1-1/2	3	JIC-G105548	25.60
MODEL W26B, W26FL								
LOADER LIFT		2PC	9107499-UP	P-UB-9	3	6	JIC-G105516	49.50
LOADER TILT		2PC		P-U-9	2-1/2	5	JIC-G32184	34.45

Replacement Kits For

J.I. CASE

J.I. CASE

Wheel Loaders - W-Series								
APPLICATION	CYL #	Piston	SERIAL #	CODE	ROD	BORE	KIT #	List \$
MODEL W26B, W26FL								
LOADER TILT		2PC		P-UB-9	2-1/2	5	JIC-G105515	40.25
STEERING				I-U-1	2		JIC-D42874	9.05
		2PC		P-UB-9	2	3-1/2	JIC-G105527	32.20
		2PC		P-U-9	2	3-1/2	JIC-G32293	26.40
		2PC		N-N-9		3-1/2	JIC-G33237	12.32
MODEL W30								
LOADER CLAM		1PC		P-UB-10	2	4	JIC-1543273C1	52.46
LOADER TILT		2PC		P-UB-9	2-1/4	4-1/2	JIC-G105520	47.70
STEERING		1PC		P-UB-10	1-3/4	3-1/4	JIC-G105547	29.44
MODEL W36								
LOADER LIFT		2PC		P-UB-9	3	6	JIC-G105516	49.50
LOADER TILT		2PC		P-UB-9	2-1/4	4-1/2	JIC-G105520	47.70
STEERING		2PC		P-UB-9	2	4	JIC-G105517	29.71
		1PC		P-UB-10	2	4	JIC-1543273C1	52.46
Wheeled Backhoe Loaders								
APPLICATION	CYL #	Piston	SERIAL #	CODE	ROD	BORE	KIT #	List \$
MODEL 380LL								
LIFT		2PC		P-U-9	1-1/2	2-1/2	JIC-G32294	20.22
TILT		2PC		P-U-9	1-1/2	2-1/2	JIC-G32294	20.22
MODEL 430 with Backhoe Models 21, 22, 23								
BACKHOE BOOM				P-U-1	1-3/4		JIC-D42872	10.05
		2PC		N-N-9		3-1/2	JIC-G33237	12.32
				P-U-1	1-3/4		JIC-D42873	13.78
		2PC		N-N-9		3	JIC-G33151	11.12
BACKHOE BUCKET		2PC		N-N-9		3	JIC-G33151	11.12
				I-U-1	2		JIC-D42874	9.05
BACKHOE DIPPER		2PC		N-N-9		3	JIC-G33151	11.12
		2PC		N-N-9		3-1/2	JIC-G33237	12.32
				I-U-1	2		JIC-D42874	9.05
BACKHOE STABILIZER				P-U-1	1-1/4		JIC-D42867	10.76
		2PC		N-N-9		2-1/2	JIC-G33193	10.85
BACKHOE SWING		2PC		N-N-9		2-1/2	JIC-G33193	10.85
				P-U-1	1-1/4		JIC-D42867	10.76
LOADER LIFT		2PC		N-N-9		2-1/2	JIC-G33193	10.85
				P-U-1	1-1/2		JIC-D42869	13.52
LOADER TILT		2PC		N-N-9		3	JIC-G33151	11.12
				P-U-1	1-1/2		JIC-D42870	13.42
MODEL 480, 480B with Backhoe Models 23, 26, 26B, 26S								
3-PT HITCH LIFT		2PC		P-UB-9	1-1/2	3	JIC-G105512	29.35
3-PT HITCH PITCH		2PC		P-U-9	1-1/4	2-1/2	JIC-G32295	19.66
		1PC		P-U-10	1-1/4	2-1/8	JIC-G105507	17.28
3-PT HITCH TILT		2PC		P-U-9	1-1/4	2-1/2	JIC-G32295	19.66
BACKHOE BOOM		2PC		P-UB-9	2-1/2	4	JIC-G34636	33.71
				P-U-1	1-3/4		JIC-D42873	13.78
		2PC		N-N-9		3-1/2	JIC-G33237	12.32

Replacement Kits For

J.I. CASE

J.I. CASE

Wheeled Backhoe Loaders								
APPLICATION	CYL #	Piston	SERIAL #	CODE	ROD	BORE	KIT #	List \$
MODEL 480, 480B with Backhoe Models 23, 26, 26B, 26S								
BACKHOE BOOM		2PC		P-UB-9	1-3/4	3-1/2	JIC-G105529	27.40
BACKHOE BUCKET		2PC		P-UB-9	1-3/4	3	JIC-G105524	32.34
				P-U-1	1-1/2		JIC-D42870	13.42
				P-U-1	1-3/4		JIC-D42872	10.05
BACKHOE DIPPER		2PC		N-N-9		3	JIC-G33151	11.12
		2PC		P-UB-9	2	3-1/2	JIC-G105527	32.20
		2PC		P-U-9	2	3-1/2	JIC-G32293	26.40
		2PC		N-N-9		3-1/2	JIC-G33237	12.32
				I-U-1	2		JIC-D42874	9.05
BACKHOE DIPPER EXT		2PC		P-UB-9	1-1/2	3	JIC-G105512	29.35
BACKHOE STABILIZER		2PC		P-UB-9	1-3/4	3-1/2	JIC-G105529	27.40
		2PC		P-U-9	1-3/4	3-1/2	JIC-G105518	29.21
		2PC		P-UB-9	1-3/4	3	JIC-G105524	32.34
		2PC		N-N-9		3	JIC-G33151	11.12
				P-U-1	1-3/4		JIC-D42872	10.05
				P-U-1	1-1/2		JIC-D42870	13.42
		2PC		N-N-9		2-1/2	JIC-G33193	10.85
				P-U-1	1-1/4		JIC-D42867	10.76
BACKHOE SWING		2PC		P-U-9	1-1/2	3-1/2	JIC-G34652	25.71
		2PC		P-UB-9	1-3/4	4	JIC-G105519	28.02
				P-U-1	1-1/2		JIC-D47896	10.83
		2PC		N-N-9		2-1/2	JIC-G33193	10.85
				P-U-1	1-1/4		JIC-D42867	10.76
LOADER LIFT		2PC		N-N-9		3-1/2	JIC-G33237	12.32
		2PC		N-N-9		2-1/2	JIC-G33193	10.85
				P-U-1	1-1/2		JIC-D42869	13.52
LOADER TILT		2PC		P-U-9	1-1/2	2-1/2	JIC-G32294	20.22
				P-U-1	1-1/2		JIC-D42870	13.42
		2PC		N-N-9		3	JIC-G33151	11.12
		2PC		P-UB-9	1-1/2	3	JIC-G105512	29.35
		2PC		P-U-9	1-1/2	2-1/2	JIC-G32294	20.22
STEERING		1PC	87357171-UP	I-O-3	3/4	1-1/2	JIC-A44644	6.81
MODEL 480C								
3-PT HITCH LIFT		1PC		P-UB-10	1-1/2	3	JIC-G109452	19.44
		2PC		P-UB-9	1-1/2	3	JIC-G105512	29.35
3-PT HITCH PITCH		1PC		P-UB-10	1-1/4	2-1/2	JIC-G109476	20.94
3-PT HITCH TILT		2PC		P-U-9	1-1/4	2-1/2	JIC-G32295	19.66
		1PC		P-UB-10	1-1/4	2-1/2	JIC-G109475	21.77
BACKHOE BOOM		1PC		P-UB-10	2-1/4	4	JIC-G109505	30.56
		2PC		P-UB-9	2-1/2	4	JIC-G34636	33.71
BACKHOE BUCKET		2PC		P-UB-9	1-3/4	3	JIC-G109462	20.09
		1PC		P-UB-10	1-3/4	3	JIC-1543262C1	38.59
BACKHOE DIPPER		2PC		P-UB-9	2	3-1/2	JIC-G109454	21.40
		1PC		P-UB-10	2	3-1/2	JIC-G109453	28.82
BACKHOE DIPPER EXT		2PC		P-UB-9	1-1/2	3	JIC-G105512	29.35

Replacement Kits For

J.I. CASE**J.I. CASE****Wheeled Backhoe Loaders**

APPLICATION	CYL #	Piston	SERIAL #	CODE	ROD	BORE	KIT #	List \$
MODEL 480C								
BACKHOE DIPPER EXT		1PC		P-UB-10	1-1/2	3	JIC-G109452	19.44
BACKHOE STABILIZER		2PC		P-UB-9	1-3/4	3	JIC-G109462	20.09
		1PC		P-UB-10	1-3/4	3-1/2	JIC-G109471	28.09
		2PC		P-UB-9	1-3/4	3-1/2	JIC-G109470	25.25
		1PC		P-UB-10	1-3/4	3	JIC-1543262C1	38.59
BACKHOE SWING				P-U-9	1-1/2	3-1/2	JIC-G34652	25.71
		1PC		P-UB-10	1-1/2	3-1/2	JIC-G109472	26.56
LOADER LIFT		2PC		P-UB-9	1-1/2	2-1/2	JIC-G109484	23.50
		1PC		P-UB-10	1-1/2	2-1/2	JIC-1543253C1	40.96
LOADER TILT		2PC		P-UB-9	1-1/2	2-1/2	JIC-G109484	23.50
		1PC		P-UB-10	1-1/2	2-1/2	JIC-1543253C1	40.96
STEERING		1PC	-->8980833	I-O-3	3/4	1-1/2	JIC-A44644	6.81
		1PC	8980834-UP	I-U-10	3/4	1-1/2	JIC-D148100	10.25
MODEL 480D, 480D LL								
3-PT HITCH LIFT		1PC		P-UB-10	1-1/2	3	JIC-G109452	19.44
3-PT HITCH PITCH		1PC		P-UB-10	1-1/4	2-1/2	JIC-G109476	20.94
3-PT HITCH TILT		1PC		P-UB-10	1-1/4	2-1/2	JIC-G109475	21.77
BACKHOE BUCKET		1PC		P-UB-10	2-1/2	3-1/2	JIC-G109504	28.46
		1PC		P-UB-10	2	3-1/4	JIC-G109465	30.53
BACKHOE DIPPER		1PC		P-UB-10	2	3-1/2	JIC-G109453	28.82
BACKHOE DIPPER EXT		1PC		P-UB-10	1-1/2	3	JIC-G109452	19.44
BACKHOE STABILIZER		1PC		P-UB-10	1-3/4	3	JIC-1543262C1	38.59
		1PC		P-UB-10	1-3/4	3-1/2	JIC-G109471	28.09
BACKHOE SWING		1PC		P-UB-10	1-1/2	3-1/2	JIC-G109472	26.56
LOADER LIFT		1PC		P-UB-10	1-1/2	2-1/2	JIC-1543253C1	40.96
LOADER TILT		1PC		P-UB-10	1-1/2	2-1/2	JIC-1543253C1	40.96
STEERING		1PC	ALL	I-U-10	3/4	1-1/2	JIC-D148100	10.25
MODEL 480E, 480E LL								
3-PT HITCH LIFT		1PC		P-UB-10	1-1/2	3	JIC-G109452	19.44
3-PT HITCH PITCH		1PC		P-UB-10	1-1/4	2-1/2	JIC-G109476	20.94
3-PT HITCH TILT		1PC		P-UB-10	1-1/4	2-1/2	JIC-G109475	21.77
BACKHOE BUCKET		1PC		P-UB-10	2	3-1/4	JIC-G109465	30.53
BACKHOE DIPPER		1PC		P-UB-10	2	3-1/2	JIC-G109453	28.82
BACKHOE DIPPER EXT		1PC		P-UB-10	1-1/2	3	JIC-G109452	19.44
BACKHOE STABILIZER		1PC		P-UB-10	1-3/4	3-1/2	JIC-G109471	28.09
BACKHOE SWING				P-UB-10	1-1/2	3-1/2	JIC-G109472	26.56
LOADER LIFT		1PC		P-UB-10	1-1/2	2-1/2	JIC-1543253C1	40.96
LOADER TILT		1PC		P-UB-10	1-1/2	2-1/2	JIC-1543253C1	40.96
STEERING		1PC	ALL	I-U-10	3/4	1-1/2	JIC-D148100	10.25
MODEL 480F, 480F LL								
3-PT HITCH LIFT	G101188	1PC		P-UB-10	1-1/4	2-1/2	JIC-1543250C1	34.91
	G101189	1PC		P-UB-10	1-1/2	3	JIC-1543252C1	40.13
3-PT HITCH PITCH	1976884C1	1PC		P-UB-10	1-1/4	2-1/2	JIC-1543249C1	43.89
BACKHOE BOOM	G102835	1PC		P-UB-10	1-3/4	4	JIC-1543264C1	48.63
BACKHOE BUCKET	G109342	1PC		P-UB-10	2-1/2	3-1/2	JIC-1543294C1	30.32

Replacement Kits For

J.I. CASE

J.I. CASE

Wheeled Backhoe Loaders								
APPLICATION	CYL #	Piston	SERIAL #	CODE	ROD	BORE	KIT #	List \$
MODEL 480F, 480F LL								
BACKHOE STAB. 480F	1340827C1	1PC		P-UB-10	1-3/4	3-1/2	JIC-1543266C1	47.58
BACKHOE SWING	G110395	1PC		P-UB-10	1-1/2	3-1/2	JIC-1543254C1	43.95
BUCKET 480F ONLY	G103503	1PC		P-UB-10	2	3-1/4	JIC-1543268C1	44.73
DIPPER 12 FT MODEL	G104844	1PC		P-UB-10	2	3-1/2	JIC-1543274C1	36.95
DIPPER 14 FT MODEL	1980159C1	1PC		P-UB-10	2	3-3/4	JIC-1980181C2	37.69
DIPPER EXT. 480F ONLY	G101203	1PC		P-UB-10	1-1/2	3	JIC-1543252C1	40.13
LOADER BUCKET	G101186	1PC		P-UB-10	1-1/2	2-1/2	JIC-1543253C1	40.96
LOADER CLAM	1346189C1	1PC		P-UB-10	1-3/4	3	JIC-1543267C1	46.74
	G101190	1PC		P-UB-10	1-3/4	3	JIC-1543262C1	38.59
LOADER LIFT	1340792C1	1PC		P-UB-10	1-3/4	3	JIC-1543267C1	46.74
MODEL 530 with Backhoe Models 31, 32, 32S								
BACKHOE BOOM		2PC		P-U-9	2	4	JIC-G32616	26.97
				I-U-1	2		JIC-D42876	9.31
		2PC		N-N-9		4	JIC-G33239	13.44
BACKHOE BUCKET		2PC		N-N-9		3-1/2	JIC-G33237	12.32
				P-U-1	1-3/4		JIC-D42873	13.78
		2PC		P-U-9	1-3/4	3-1/2	JIC-G105518	29.21
BACKHOE DIPPER				I-U-1	2		JIC-D42876	9.31
		2PC		P-UB-9	2	4	JIC-G105526	30.90
		2PC		N-N-9		4	JIC-G33239	13.44
BACKHOE STABILIZER		2PC		N-N-9		3-1/2	JIC-G33237	12.32
				P-U-1	1-3/4		JIC-D42873	13.78
		2PC		P-UB-9	1-3/4	3-1/2	JIC-G105529	27.40
		2PC		P-U-9	1-3/4	3-1/2	JIC-G105518	29.21
BACKHOE SWING		2PC		P-U-9	1-3/4	4	JIC-G32617	28.09
		2PC		N-N-9		4	JIC-G33239	13.44
				P-U-1	1-3/4		JIC-D42875	10.67
LOADER HYDRA-LEVELING				P-U-1	1-3/4		JIC-D42872	10.05
		2PC		N-N-9		3	JIC-G33151	11.12
LOADER LIFT		2PC		N-N-9		3	JIC-G33151	11.12
				P-U-1	1-1/2		JIC-D42870	13.42
		2PC		N-N-9		2-1/2	JIC-G33193	10.85
				P-U-1	1-1/2		JIC-D42869	13.52
LOADER TILT		2PC		N-N-9		2-1/2	JIC-G33193	10.85
				P-U-1	1-1/2		JIC-D42869	13.52
				P-U-1	1-1/4		JIC-D42867	10.76
MODEL 580 with Backhoe Models 33, 33S								
3-PT HITCH LIFT		2PC		P-U-9	1-1/2	2-1/2	JIC-G32294	20.22
3-PT HITCH PITCH		2PC		P-U-9	1-1/4	2-1/2	JIC-G32295	19.66
		1PC		P-U-10	1-1/4	2-1/8	JIC-G105507	17.28
3-PT HITCH TILT		2PC		P-UB-9	1-1/2	3	JIC-G105512	29.35
BACKHOE BOOM		2PC		N-N-9		4	JIC-G33239	13.44
		1PC		P-UB-9	2-1/4	4-1/2	JIC-G105520	47.70
		2PC		N-N-9		4-1/2	JIC-DTVS4.5P	26.62

Replacement Kits For

J.I. CASE

J.I. CASE

Wheeled Backhoe Loaders								
APPLICATION	CYL #	Piston	SERIAL #	CODE	ROD	BORE	KIT #	List \$
MODEL 580 with Backhoe Models 33, 33S								
BACKHOE BOOM				P-U-1	2-1/4		JIC-D42878	12.24
		2PC		P-UB-9	2	4	JIC-G105517	29.71
		2PC		P-U-9	2	4	JIC-G32299	29.21
				I-U-1	2		JIC-D42876	9.31
BACKHOE BUCKET		2PC		P-UB-9	2	3-1/2	JIC-G105527	32.20
		2PC		P-U-9	2	3-1/2	JIC-G32293	26.40
		2PC		N-N-9		3-1/2	JIC-G33237	12.32
		2PC		P-U-1	1-3/4		JIC-D42873	13.78
BACKHOE DIPPER				P-U-1	2-1/4		JIC-D42878	12.24
				I-U-1	2		JIC-D42874	9.05
		2PC		P-U-9	2	4	JIC-G32299	29.21
		2PC		N-N-9		4	JIC-G33239	13.44
BACKHOE DIPPER EXT		2PC		P-UB-9	2	4	JIC-G105517	29.71
				I-U-1	2		JIC-D42876	9.31
				P-U-1	1-3/4		JIC-D42873	13.78
		2PC		N-N-9		3-1/2	JIC-G33237	12.32
BACKHOE STABILIZER		2PC		P-UB-9	1-3/4	3-1/2	JIC-G105529	27.40
		2PC		P-UB-9	1-1/2	3	JIC-G105512	29.35
				P-U-1	1-3/4		JIC-D42873	13.78
		2PC		N-N-9		3-1/2	JIC-G33237	12.32
BACKHOE SWING		2PC		P-U-9	1-3/4	3-1/2	JIC-G105518	29.21
		2PC		P-UB-9	1-3/4	3-1/2	JIC-G105529	27.40
				P-U-1	1-3/4		JIC-D42875	10.67
		2PC		N-N-9		4	JIC-G33239	13.44
LOADER CLAM		2PC		P-UB-9	1-3/4	4	JIC-G105519	28.02
LOADER GRAPPLE		2PC		P-UB-9	1-3/4	3	JIC-G105524	32.34
				P-U-9	1-1/2	2-1/2	JIC-G32294	20.22
LOADER HYDRA-LEVELING				P-U-1	1-1/2		JIC-D42869	13.52
		2PC		N-N-9		2-1/2	JIC-G33193	10.85
				P-U-1	1-3/4		JIC-D42872	10.05
		2PC		N-N-9		3	JIC-G33151	11.12
LOADER LIFT		2PC		P-UB-9	1-3/4	3	JIC-G105524	32.34
		2PC		N-N-9		3	JIC-G33151	11.12
		2PC		P-UB-9	1-1/2	3	JIC-G105512	29.35
LOADER TILT				P-U-1	1-1/2		JIC-D42870	13.42
				P-U-1	1-1/2		JIC-D42869	13.52
		2PC		N-N-9		2-1/2	JIC-G33193	10.85
		2PC		P-U-9	1-1/2	2-1/2	JIC-G32294	20.22
MODEL 580 Super E								
3-PT HITCH LIFT		1PC		P-UB-10	1-1/2	3	JIC-G109452	19.44
3-PT HITCH PITCH		1PC		P-UB-10	1-1/4	2-1/2	JIC-G109476	20.94
3-PT HITCH TILT		1PC		P-UB-10	1-1/4	2-1/2	JIC-G109475	21.77
BACKHOE BOOM		1PC		P-UB-10	1-3/4	3-1/4	JIC-1543265C1	47.82
BACKHOE BUCKET		1PC		P-UB-10	2-1/2	4	JIC-G109424	33.66

Replacement Kits For

J.I. CASE

J.I. CASE

Wheeled Backhoe Loaders								
APPLICATION	CYL #	Piston	SERIAL #	CODE	ROD	BORE	KIT #	List \$
MODEL 580 Super E								
BACKHOE BUCKET		1PC		P-UB-10	2-1/2	3-1/2	JIC-G109504	28.46
BACKHOE DIPPER		1PC		P-UB-10	2	4	JIC-1543273C1	52.46
BACKHOE DIPPER EXT		1PC		P-UB-10	1-1/2	3	JIC-G109452	19.44
BACKHOE STABILIZER		1PC		P-UB-10	2	4	JIC-1543273C1	52.46
BACKHOE SWING		1PC		P-UB-10	2	4	JIC-1543273C1	52.46
LOADER CLAM		1PC		P-UB-10	1-3/4	3	JIC-1543262C1	38.59
LOADER LIFT		1PC		P-UB-10	1-3/4	3	JIC-1543262C1	38.59
LOADER TILT		1PC		P-UB-10	1-1/2	2-1/2	JIC-1543253C1	40.96
STEERING		1PC		I-U-10	3/4	1-1/2	JIC-D148100	10.25
MODEL 580 Super L								
BACKHOE BOOM	144200A1	1PC		P-UB-10	2-1/4	5	JIC-1542919C2	129.04
BACKHOE BUCKET	110290A1	1PC		P-UB-10	2-1/2	3-1/2	JIC-1542923C2	60.32
	235916A1	1PC		P-UB-10	2-1/2	3-1/2	JIC-1542923C2	60.32
BACKHOE DIPPER	126151A1	1PC		P-UB-10	2-1/2	5	JIC-1542915C2	57.03
	183795A1	1PC		P-UB-10	2-1/2	5	JIC-1542915C2	57.03
	183795A2	1PC		P-UB-10	2-1/2	5	JIC-1542915C2	57.03
BACKHOE DIPPER EXT	1340969C2	1PC		P-UB-10	1-3/4	3	JIC-1543267C1	46.74
BACKHOE STABILIZER	143695A1	1PC		P-UB-10	2	4-1/4	JIC-1543275C1	34.96
	143697A1	1PC		P-UB-10	2	4-1/4	JIC-1543275C1	34.96
	199720A1	1PC		P-UB-10	2	4-1/4	JIC-1543275C1	34.96
	199721A1	1PC		P-UB-10	2	4-1/4	JIC-1543275C1	34.96
BACKHOE SWING	139808A1	1PC		P-UB-10	2	4	JIC-122535A1	80.85
LOADER BUCKET	113133A2	1PC		P-UB-10	1-1/2	3	JIC-1543256C1	37.80
LOADER CLAM	1346189C1	1PC		P-UB-10	1-3/4	3	JIC-1543267C1	46.74
	1346190C1	1PC		P-UB-10	1-3/4	3	JIC-1543267C1	46.74
LOADER LIFT	112366A2	1PC		P-UB-10	1-3/4	3-1/4	JIC-1543260C1	47.82
MODEL 580B with Backhoe Model 35								
3-PT HITCH LIFT		1PC		P-UB-10	1-1/2	3	JIC-G105548	25.60
		2PC		P-UB-9	1-1/2	3	JIC-G105512	29.35
3-PT HITCH PITCH		2PC		P-U-9	1-1/4	2-1/2	JIC-G32295	19.66
		1PC		P-U-10	1-1/4	2-1/8	JIC-G105507	17.28
3-PT HITCH TILT		1PC		P-UB-10	1-1/4	2-1/2	JIC-G105551	21.77
		2PC		P-U-9	1-1/4	2-1/2	JIC-G32295	19.66
BACKHOE BOOM		2PC		P-UB-9	1-3/4	3-1/4	JIC-G105528	28.09
		1PC		P-UB-10	1-3/4	3-1/4	JIC-G105547	29.44
BACKHOE BUCKET		2PC		P-UB-9	2	3-1/2	JIC-G105527	32.20
		1PC		P-UB-10	2	3-1/2	JIC-G105546	28.82
BACKHOE DIPPER		1PC		P-UB-10	2	4	JIC-1543273C1	52.46
		2PC		P-UB-9	2	4	JIC-G105517	29.71
BACKHOE DIPPER EXT		1PC		P-UB-10	1-1/2	3	JIC-G105548	25.60
		2PC		P-UB-9	1-1/2	3	JIC-G105512	29.35
BACKHOE STABILIZER		2PC		P-UB-9	2	3-1/2	JIC-G105527	32.20
		2PC		P-UB-9	2	4	JIC-G105517	29.71
		1PC		P-UB-10	2	4	JIC-1543273C1	52.46
		2PC		P-UB-9	1-3/4	3-1/2	JIC-G105529	27.40

Replacement Kits For

J.I. CASE

J.I. CASE

Wheeled Backhoe Loaders								
APPLICATION	CYL #	Piston	SERIAL #	CODE	ROD	BORE	KIT #	List \$
MODEL 580B with Backhoe Model 35								
BACKHOE SWING		1PC		P-UB-10	2	4	JIC-1543273C1	52.46
		2PC		P-UB-9	2	4	JIC-G105517	29.71
LOADER CLAM		1PC		P-UB-10	1-3/4	3	JIC-G105549	32.58
		2PC		P-UB-9	1-3/4	3	JIC-G105524	32.34
LOADER HYDRA-LEVELING		2PC		P-UB-9	1-3/4	3	JIC-G105524	32.34
		1PC		P-UB-10	1-3/4	3	JIC-G105549	32.58
LOADER LIFT		1PC		P-UB-10	1-1/2	3	JIC-G105548	25.60
		2PC		P-UB-9	1-1/2	3	JIC-G105512	29.35
LOADER TILT		2PC		P-U-9	1-1/2	2-1/2	JIC-G32294	20.22
		1PC		P-UB-10	1-1/2	2-1/2	JIC-G105550	19.21
LOGGING FORK GRAPPLE		1PC		P-UB-10	1-1/2	2-1/2	JIC-G105550	19.21
		2PC		P-U-9	1-1/2	2-1/2	JIC-G32294	20.22
STEERING		1PC		I-O-3	3/4	1-1/2	JIC-A44644	6.81
MODEL 580C								
3-PT HITCH LIFT		2PC		P-UB-9	1-1/2	3	JIC-G105512	29.35
		1PC		P-UB-10	1-1/2	3	JIC-G109452	19.44
3-PT HITCH PITCH		1PC		P-UB-10	1-1/4	2-1/2	JIC-G109476	20.94
3-PT HITCH TILT		1PC		P-UB-10	1-1/4	2-1/2	JIC-G109475	21.77
		2PC		P-U-9	1-1/4	2-1/2	JIC-G32295	19.66
BACKHOE BOOM		2PC		P-UB-9	1-3/4	3-1/4	JIC-G105528	28.09
		1PC		P-UB-10	1-3/4	3-1/4	JIC-1543265C1	47.82
BACKHOE BUCKET		2PC		P-UB-9	2	3-1/2	JIC-G109454	21.40
		1PC		P-UB-10	2	3-1/2	JIC-G109453	28.82
BACKHOE DIPPER		1PC		P-UB-10	2	4	JIC-1543273C1	52.46
		2PC		P-UB-9	2	4	JIC-G109421	22.54
BACKHOE DIPPER EXT		2PC		P-UB-9	1-1/2	3	JIC-G105512	29.35
		1PC		P-UB-10	1-1/2	3	JIC-G109452	19.44
BACKHOE STABILIZER		1PC		P-UB-10	2	4	JIC-1543273C1	52.46
		2PC		P-UB-9	2	4	JIC-G109421	22.54
BACKHOE SWING		1PC		P-UB-10	2	4	JIC-1543273C1	52.46
		2PC		P-UB-9	2	4	JIC-G109421	22.54
LOADER CLAM		2PC		P-UB-9	1-3/4	3	JIC-G109462	20.09
		1PC		P-UB-10	1-3/4	3	JIC-1543262C1	38.59
LOADER GRAPPLE		1PC		P-UB-10	1-1/2	2-1/2	JIC-1543253C1	40.96
		2PC		P-UB-9	1-1/2	2-1/2	JIC-G109484	23.50
LOADER LIFT		1PC		P-UB-10	1-3/4	3	JIC-1543262C1	38.59
		2PC		P-UB-9	1-3/4	3	JIC-G109462	20.09
LOADER TILT		1PC		P-UB-10	1-1/2	2-1/2	JIC-1543253C1	40.96
		2PC		P-UB-9	1-1/2	2-1/2	JIC-G109484	23.50
STEERING		1PC	-->8983287	I-O-3	3/4	1-1/2	JIC-A44644	6.81
		1PC	8983288-UP	I-U-10	3/4	1-1/2	JIC-D148100	10.25
MODEL 580D, 580 Super D								
3-PT HITCH LIFT		1PC		P-UB-10	1-1/2	3	JIC-G109452	19.44

Replacement Kits For

J.I. CASE

J.I. CASE

Wheeled Backhoe Loaders								
APPLICATION	CYL #	Piston	SERIAL #	CODE	ROD	BORE	KIT #	List \$
MODEL 580D, 580 Super D								
3-PT HITCH PITCH		1PC		P-UB-10	1-1/4	2-1/2	JIC-G109476	20.94
3-PT HITCH TILT		1PC		P-UB-10	1-1/4	2-1/2	JIC-G109475	21.77
BACKHOE BOOM		1PC		P-UB-10	1-3/4	3-1/4	JIC-1543265C1	47.82
BACKHOE BUCKET		1PC		P-UB-10	2-1/2	3-1/2	JIC-G109504	28.46
		1PC		P-UB-10	2	3-1/2	JIC-G109453	28.82
BACKHOE DIPPER		1PC		P-UB-10	2-1/2	4	JIC-G109424	33.66
		1PC		P-UB-10	2	4	JIC-1543273C1	52.46
BACKHOE DIPPER EXT		1PC		P-UB-10	1-1/2	3	JIC-G109452	19.44
BACKHOE STABILIZER		1PC		P-UB-10	2	4	JIC-1543273C1	52.46
BACKHOE SWING		1PC		P-UB-10	2	4	JIC-1543273C1	52.46
LOADER CLAM		1PC		P-UB-10	1-3/4	3	JIC-1543262C1	38.59
LOADER LIFT		1PC		P-UB-10	1-3/4	3	JIC-1543262C1	38.59
LOADER TILT		1PC		P-UB-10	1-1/2	2-1/2	JIC-1543253C1	40.96
STEERING		1PC		I-U-10	3/4	1-1/2	JIC-D148100	10.25
MODEL 580F								
BACKHOE BOOM		1PC		P-UB-10	1-3/4	3-1/4	JIC-G105547	29.44
		2PC		P-UB-9	1-3/4	3-1/4	JIC-G105528	28.09
BACKHOE BUCKET		2PC		P-UB-9	2	3-1/2	JIC-G105527	32.20
		1PC		P-UB-10	2	3-1/2	JIC-G105546	28.82
BACKHOE DIPPER		2PC		P-UB-9	2	4	JIC-G105517	29.71
		1PC		P-UB-10	2	4	JIC-1543273C1	52.46
BACKHOE STABILIZER		2PC	-->3.775.176	P-UB-9	2	4	JIC-G105517	29.71
		2PC	-->3.785.895	P-UB-9	1-3/4	3	JIC-G105524	32.34
		1PC	3.775.177-UP	P-UB-10	2	4	JIC-1543273C1	52.46
		1PC	3.785.896-UP	P-UB-10	1-3/4	3	JIC-G105549	32.58
BACKHOE SWING		2PC	-->3.775.161	P-UB-9	2	4	JIC-G105517	29.71
		2PC	-->3.785.922	P-U-9	1-3/4	4	JIC-G34626	30.34
		1PC	3.775.162-UP	P-UB-10	2	4	JIC-1543273C1	52.46
		1PC	3.785.923- 3.787.235	P-UB-10	1-3/4	4	JIC-G105552	30.68
BOOM EXTENSION		1PC		P-UB-10	1-1/2	3	JIC-G105548	25.60
		2PC		P-UB-9	1-1/2	3	JIC-G105512	29.35
LOADER CLAM		1PC		P-UB-10	1-3/4	3	JIC-G105549	32.58
		2PC		P-UB-9	1-3/4	3	JIC-G105524	32.34
LOADER LIFT		1PC		P-UB-10	2	3-1/4	JIC-G105553	32.28
LOADER TILT		1PC		P-UB-10	1-1/2	2-1/2	JIC-G105550	19.21
		2PC		P-U-9	1-1/2	2-1/2	JIC-G32294	20.22
STEERING		1PC	3.736.937-UP	I-U-10	3/4	1-1/2	JIC-D148100	10.25
MODEL 580K								
3-PT HITCH LIFT & TILT		1PC		P-UB-10	1-1/4	3	JIC-G110048	20.02
		1PC		P-UB-10	1-1/4	2-3/4	JIC-G110047	21.20
BACKHOE BOOM		1PC		P-UB-10	2-1/4	5	JIC-G110583	82.01
BACKHOE BUCKET		1PC		P-UB-10	2-1/2	3-1/2	JIC-G110046	28.21
BACKHOE DIPPER		1PC		P-UB-10	2-1/2	5	JIC-1542915C2	57.03
BACKHOE DIPPER EXT		1PC		P-UB-10	1-3/4	3	JIC-G110049	25.23

Replacement Kits For

J.I. CASE

J.I. CASE
Wheeled Backhoe Loaders

APPLICATION	CYL #	Piston	SERIAL #	CODE	ROD	BORE	KIT #	List \$
MODEL 580K								
BACKHOE STABILIZER		1PC		P-UB-10	2	4-1/4	JIC-1543275C1	34.96
BACKHOE SWING		1PC		P-UB-10	1-3/4	3-1/2	JIC-G110621	26.27
		1PC		P-UB-10	1-3/4	3-1/4	JIC-G110053	23.14
LOADER CLAM		1PC		P-UB-10	1-3/4	3	JIC-1543262C1	38.59
LOADER LIFT		1PC		P-UB-10	1-3/4	3-1/4	JIC-G110053	23.14
LOADER TILT		1PC		P-UB-10	1-1/2	3	JIC-G110050	22.26
SIDE SHIFT STABILIZER		1PC		P-UB-10	1-3/4	3	JIC-1543262C1	38.59
SIDE SHIFT SWING		1PC		P-UB-10	2	4	JIC-1543269C1	47.99
STEERING		1PC		P-U-10	1-1/2	2-3/4	JIC-G110045	29.21
MODEL 580L								
3-PT HITCH LIFT	137512A1	1PC		P-UB-10	1-1/2	3	JIC-1543256C1	37.80
	137912A1	1PC		P-U-10	1-1/4	2-1/2	JIC-183286A1	30.03
	196832A1	1PC		P-UB-10	1-1/2	3	JIC-1543256C1	37.80
3-PT HITCH PITCH	138235A1	1PC		P-U-10	1-1/4	2-1/2	JIC-183286A1	30.03
BACKHOE BUCKET	128760A1	1PC		P-UB-10	2-1/4	3-1/4	JIC-131750A2	40.76
BACKHOE BOOM	182106A1	1PC		P-UB-10	2-1/4	4-1/2	JIC-182218A1	58.69
BACKHOE DIPPER	175774A1	1PC		P-UB-10	2-1/4	4-1/4	JIC-234844A1	60.92
	233114A1	1PC		P-UB-10	2-1/4	4-1/4	JIC-234844A1	60.92
BACKHOE DIPPER EXT	1340970C2	1PC		P-UB-10	1-3/4	3	JIC-1543267C1	46.74
BACKHOE STABILIZER	143574A1	1PC		P-UB-10	2	4	JIC-1543269C1	47.99
	143575A1	1PC		P-UB-10	2	4	JIC-1543269C1	47.99
	195503A1	1PC		P-UB-10	2	4	JIC-1543269C1	47.99
	195504A1	1PC		P-UB-10	2	4	JIC-1543269C1	47.99
BACKHOE SWING	139808A1	1PC		P-UB-10	2	4	JIC-122535A1	80.85
	139808A2	1PC		P-UB-10	2	4	JIC-122535A1	80.85
	188027A1	1PC		P-UB-10	2	3-3/4	JIC-191747A1	55.85
LOADER BUCKET	175238A1	1PC		P-UB-10	1-1/2	2-3/4	JIC-175251A1	42.34
LOADER CLAM	1346189C1	1PC		P-UB-10	1-3/4	3	JIC-1543267C1	46.74
LOADER LIFT	131417A1	1PC		P-UB-10	1-3/4	3	JIC-1543267C1	46.74
MODEL 580SK								
BACKHOE BOOM		1PC		P-UB-10	2-1/4	5	JIC-G110583	82.01
BACKHOE BUCKET		1PC		P-UB-10	2-1/2	3-1/2	JIC-G110046	28.21
BACKHOE DIPPER		1PC		P-UB-10	2-1/2	5	JIC-G110582	34.15
BACKHOE DIPPER EXT		1PC		P-UB-10	1-3/4	3	JIC-G110049	25.23
BACKHOE STABILIZER		1PC		P-UB-10	2	4-1/4	JIC-1543275C1	34.96
BACKHOE SWING		1PC		P-UB-10	1-3/4	3-1/2	JIC-G110621	26.27
LOADER CLAM		1PC		P-UB-10	1-3/4	3	JIC-1543262C1	38.59
LOADER LIFT		1PC		P-UB-10	1-3/4	3-1/2	JIC-G110621	26.27
LOADER TILT		1PC		P-UB-10	1-1/2	3	JIC-G110050	22.26
SIDE SHIFT SWING		1PC		P-UB-10	2-1/4	4-1/2	JIC-1543279C1	37.07
MODEL 580SL Construction King								
BACKHOE BOOM	144200A1			P-UB-10	2-1/4	5	JIC-1542919C2	129.04
BACKHOE BUCKET	110290A1			P-UB-10	2-1/2	3-1/2	JIC-1542923C2	60.32
	235916A1			P-UB-10	2-1/2	3-1/2	JIC-1542923C2	60.32
BACKHOE DIPPER	126151A1			P-UB-10	2-1/2	5	JIC-1542915C2	57.03

Replacement Kits For

J.I. CASE

J.I. CASE

Wheeled Backhoe Loaders								
APPLICATION	CYL #	Piston	SERIAL #	CODE	ROD	BORE	KIT #	List \$
MODEL 580SL Construction King								
BACKHOE DIPPER	183795A1			P-UB-10	2-1/2	5	JIC-1542915C2	57.03
BACKHOE DIPPER EXT	1340969C2			P-UB-10	1-3/4	3	JIC-1543267C1	46.74
BACKHOE SWING	139808A1			P-UB-10	2	4	JIC-122535A1	80.85
	139808A2			P-UB-10	2	4	JIC-122535A1	80.85
LOADER BUCKET	113133A2			P-UB-10	1-1/2	3	JIC-1543256C1	37.80
LOADER CLAM - LH	1346189C1			P-UB-10	1-3/4	3	JIC-1543267C1	46.74
LOADER CLAM - RH	1346190C1			P-UB-10	1-3/4	3	JIC-1543267C1	46.74
LOADER LIFT	112366A2			P-UB-10	1-3/4	3-1/4	JIC-1543260C1	47.82
STABILIZER - LH	143697A1			P-UB-10	2	4-1/4	JIC-1543275C1	34.96
	199721A1			P-UB-10	2	4-1/4	JIC-1543275C1	34.96
STABILIZER - RH	143695A1			P-UB-10	2	4-1/4	JIC-1543275C1	34.96
	199720A1			P-UB-10	2	4-1/4	JIC-1543275C1	34.96
MODEL 590								
BACKHOE BOOM	1980395C5	1PC		P-UB-10	2-1/2	5-1/2	JIC-1980412C2	118.74
	1980395C6	1PC		P-UB-10	2-1/2	5-1/2	JIC-1980412C2	118.74
BACKHOE BUCKET	1986902C1	1PC		P-UB-10	2-1/2	3-1/2	JIC-1542923C2	60.32
	1986902C2	1PC		P-UB-10	2-1/2	3-1/2	JIC-1542923C2	60.32
BACKHOE DIPPER	1994520C1	1PC		P-UB-10	2-3/4	5-1/2	JIC-1994527C2	115.44
	1994520C2	1PC		P-UB-10	2-3/4	5-1/2	JIC-1994527C2	115.44
BACKHOE DIPPER EXT	1340853C2	1PC		P-UB-10	1-3/4	3	JIC-1543267C1	46.74
BACKHOE STABILIZER	110885A1	1PC		P-UB-10	2-1/4	5	JIC-1543289C2	50.76
	110886A1	1PC		P-UB-10	2-1/4	5	JIC-1543289C2	50.76
	1986810C1	1PC		P-UB-10	2-1/4	5	JIC-1543289C2	50.76
	1986811C1	1PC		P-UB-10	2-1/4	5	JIC-1543289C2	50.76
BACKHOE SWING	1343584C1	1PC		P-UB-10	2	3-3/4	JIC-1980181C2	37.69
	1343584C2	1PC		P-UB-10	2	3-3/4	JIC-1980181C2	37.69
LOADER BUCKET	110306A1	1PC		P-UB-10	1-1/2	3	JIC-1543256C1	37.80
	110309A1	1PC		P-UB-10	1-1/2	3	JIC-1543256C1	37.80
	G108486	1PC		P-UB-10	1-1/2	3	JIC-1543256C1	37.80
	G108487	1PC		P-UB-10	1-1/2	3	JIC-1543256C1	37.80
LOADER CLAM	1346189C1	1PC		P-UB-10	1-3/4	3	JIC-1543267C1	46.74
	1346190C1	1PC		P-UB-10	1-3/4	3	JIC-1543267C1	46.74
LOADER LIFT	110875A1	1PC		P-UB-10	1-3/4	3-1/2	JIC-1543266C1	47.58
	1542743C1	1PC		P-UB-10	1-3/4	3-1/2	JIC-1543266C1	47.58
	1980220C2	1PC		P-UB-10	1-3/4	3-1/2	JIC-1543266C1	47.58
MODEL 590 Super L								
BACKHOE BOOM	175785A1	1PC		P-UB-10	2-1/2	5-1/2	JIC-1980412C2	118.74
BACKHOE BUCKET	1986902C2	1PC		P-UB-10	2-1/2	3-1/2	JIC-1542923C2	60.32
	238435A1	1PC		P-UB-10	2-1/2	3-1/2	JIC-1542923C2	60.32
BACKHOE DIPPER	140965A1	1PC		P-UB-10	2-3/4	5-1/2	JIC-179011A1	91.16
BACKHOE DIPPER EXT	1340853C2	1PC		P-UB-10	1-3/4	3	JIC-1543267C1	46.74
BACKHOE STABILIZER	177256A1	1PC		P-UB-10	2-1/4	5	JIC-1543289C2	50.76
	177257A1	1PC		P-UB-10	2-1/4	5	JIC-1543289C2	50.76
BACKHOE SWING	139808A1	1PC		P-UB-10	2	4	JIC-122535A1	80.85
LOADER BUCKET	113133A2	1PC		P-UB-10	1-1/2	3	JIC-1543256C1	37.80

Replacement Kits For

J.I. CASE**J.I. CASE**

Wheeled Backhoe Loaders								
APPLICATION	CYL #	Piston	SERIAL #	CODE	ROD	BORE	KIT #	List \$
MODEL 590 Super L								
LOADER CLAM	1346189C1	1PC		P-UB-10	1-3/4	3	JIC-1543267C1	46.74
	1346190C1	1PC		P-UB-10	1-3/4	3	JIC-1543267C1	46.74
LOADER LIFT	133936A1	1PC		P-UB-10	1-3/4	3-1/2	JIC-1543266C1	47.58
MODEL 680								
3-PT HITCH PITCH		1PC	ALL	P-UB-10	1-1/4	2-1/2	JIC-G110055	32.84
BACKHOE BOOM				P-U-1	2-1/4		JIC-D42878	12.24
		2PC		N-N-9		4-1/2	JIC-DTVS4.5P	26.62
BACKHOE BUCKET				I-U-1	2-1/4		JIC-D42877	9.97
		2PC		N-N-9		4	JIC-G33239	13.44
BACKHOE DIPPER				P-U-1	2-1/4		JIC-D42878	12.24
		2PC		N-N-9		4-1/2	JIC-DTVS4.5P	26.62
BACKHOE STABILIZER		2PC		N-N-9		3-1/2	JIC-G33237	12.32
				P-U-1	1-3/4		JIC-D42873	13.78
BACKHOE SWING		2PC		N-N-9		4	JIC-G33239	13.44
				P-U-1	1-3/4		JIC-D42875	10.67
LOADER TILT				P-U-1	1-3/4		JIC-D42873	13.78
		2PC		N-N-9		3-1/2	JIC-G33237	12.32
MODEL 680B								
BACKHOE BOOM		2PC		P-U-9	2-1/4	5	JIC-G32696	37.64
BACKHOE BUCKET				I-U-1	2-1/4		JIC-D42877	9.97
		2PC		P-UB-9	2-1/2	4	JIC-G34636	33.71
		2PC		N-N-9		4	JIC-G33239	13.44
BACKHOE DIPPER		2PC		P-UB-9	2-1/4	4-1/2	JIC-G105520	47.70
		2PC		N-N-9		4-1/2	JIC-DTVS4.5P	26.62
				P-U-1	2-1/4		JIC-D42878	12.24
BACKHOE STABILIZER				I-U-1	2		JIC-D42876	9.31
		2PC		N-N-9		4	JIC-G33239	13.44
		2PC		P-U-9	2	4	JIC-G32299	29.21
BACKHOE SWING		2PC		P-UB-9	2	4-1/2	JIC-G105525	38.20
		2PC		P-U-9	2	4-1/2	JIC-G32695	39.33
LOADER HYDRA-LEVELING				P-U-1	1-3/4		JIC-D42872	10.05
		2PC		N-N-9		3	JIC-G33151	11.12
		2PC		P-UB-9	1-3/4	3	JIC-G105524	32.34
LOADER LIFT		2PC		P-U-9	2	3-1/2	JIC-G34648	29.78
		2PC		N-N-9		3-1/2	JIC-G33237	12.32
				I-U-1	2		JIC-D42874	9.05
LOADER TILT				P-U-1	1-3/4		JIC-D42872	10.05
		2PC		N-N-9		3	JIC-G33151	11.12
		2PC		P-UB-9	1-3/4	3	JIC-G105524	32.34
MODEL 680C								
3-PT HITCH PITCH		2PC		P-U-9	1-1/2	2-1/2	JIC-G32294	20.22
		1PC		P-UB-10	1-1/2	2-1/2	JIC-G105550	19.21
3-PT HITCH TILT		2PC		P-U-9	1-1/2	2-1/2	JIC-G32294	20.22
		1PC		P-UB-10	1-1/2	2-1/2	JIC-G105550	19.21

Replacement Kits For

J.I. CASE

J.I. CASE

Wheeled Backhoe Loaders								
APPLICATION	CYL #	Piston	SERIAL #	CODE	ROD	BORE	KIT #	List \$
MODEL 680C								
BACKHOE BOOM		2PC		P-U-9	2-1/4	5	JIC-G32696	37.64
BACKHOE BUCKET		2PC		P-UB-9	2-1/2	4	JIC-G34636	33.71
		1PC		P-UB-10	1-1/4	2-1/2	JIC-G105551	21.77
BACKHOE DIPPER				P-U-1	2-1/4		JIC-D42878	12.24
		2PC		P-UB-9	2-1/4	4-1/2	JIC-G105520	47.70
		2PC		P-UB-9	1-1/2	3	JIC-G105512	29.35
		2PC		N-N-9		4-1/2	JIC-DTVS4.5P	26.62
BACKHOE DIPPER EXT		2PC		P-UB-9	1-1/2	3	JIC-G105512	29.35
BACKHOE STABILIZER				I-U-1	2		JIC-D42876	9.31
		1PC		P-UB-10	2	4	JIC-1543273C1	52.46
		2PC		P-UB-9	2	4	JIC-G105517	29.71
		2PC		N-N-9		4	JIC-G33239	13.44
		2PC		P-U-9	2	4	JIC-G32299	29.21
BACKHOE SWING		2PC		P-UB-9	2	4-1/2	JIC-G105525	38.20
		2PC		P-U-9	2	4-1/2	JIC-G32695	39.33
LOADER CLAM		1PC		P-UB-10	1-1/2	3	JIC-G105548	25.60
		2PC		P-UB-9	1-1/2	3	JIC-G105512	29.35
LOADER HYDRA-LEVELING		1PC		P-UB-10	1-1/2	3	JIC-G105548	25.60
		2PC		P-UB-9	1-3/4	3	JIC-G105524	32.34
LOADER LIFT		1PC		P-UB-10	2	3-1/2	JIC-G105546	28.82
		2PC		P-UB-9	2	3-1/2	JIC-G105521	28.09
		2PC		P-U-9	2	3-1/2	JIC-G34648	29.78
LOADER TILT		2PC		P-UB-9	1-3/4	3	JIC-G105524	32.34
		2PC		P-U-9	1-3/4	3	JIC-G34643	25.84
		1PC		P-UB-10	1-3/4	3	JIC-G105549	32.58
MODEL 680CK								
BACKHOE BOOM				P-U-1	2-1/4		JIC-D42878	12.24
		2PC		N-N-9		4-1/2	JIC-DTVS4.5P	26.62
BACKHOE BUCKET		2PC		N-N-9		4	JIC-G33239	13.44
				I-U-1	2-1/4		JIC-D42877	9.97
BACKHOE DIPPER		2PC		N-N-9		4-1/2	JIC-DTVS4.5P	26.62
				P-U-1	2-1/4		JIC-D42878	12.24
BACKHOE STABILIZER				I-U-1	2		JIC-D42876	9.31
		2PC		N-N-9		4	JIC-G33239	13.44
BACKHOE SWING		2PC		N-N-9		4	JIC-G33239	13.44
				P-U-1	1-3/4		JIC-D42875	10.67
LOADER HYDRA-LEVELING				P-U-1	1-3/4		JIC-D42872	10.05
		2PC		N-N-9		3	JIC-G33151	11.12
LOADER LIFT		2PC		N-N-9		3-1/2	JIC-G33237	12.32
				I-U-1	2		JIC-D42874	9.05
LOADER TILT		2PC		N-N-9		3	JIC-G33151	11.12
				P-U-1	1-3/4		JIC-D42872	10.05

Replacement Kits For

J.I. CASE

J.I. CASE
Wheeled Backhoe Loaders

APPLICATION	CYL #	Piston	SERIAL #	CODE	ROD	BORE	KIT #	List \$
MODEL 680E								
BACKHOE BOOM		2PC		P-U-9	2-1/4	4	JIC-G34827	48.88
		1PC		P-UB-10	2-1/4	4	JIC-G105556	33.28
BACKHOE BUCKET		1PC		P-UB-10	2-1/4	4	JIC-G105556	33.28
		2PC		P-UB-9	2-1/2	4	JIC-G34636	33.71
BACKHOE DIPPER		2PC		P-UB-9	2-1/2	4-1/2	JIC-G105513	49.19
BACKHOE DIPPER EXT		1PC		P-UB-10	1-1/2	3	JIC-G105548	25.60
		2PC		P-UB-9	1-1/2	3	JIC-G105512	29.35
BACKHOE STABILIZER		2PC		P-UB-9	2	4-1/2	JIC-G105525	38.20
BACKHOE SWING		2PC		P-UB-9	2	4	JIC-G105517	29.71
		1PC		P-UB-10	2	4	JIC-1543273C1	52.46
LOADER CLAM		2PC		P-UB-9	1-1/2	3	JIC-G105512	29.35
		1PC		P-UB-10	1-1/2	3	JIC-G105548	25.60
LOADER LIFT		1PC		P-UB-10	2	3-1/2	JIC-G105546	28.82
		2PC		P-UB-9	2	3-1/2	JIC-G105521	28.09
LOADER TILT		2PC		P-U-9	1-3/4	3	JIC-G34643	25.84
		1PC		P-UB-10	1-3/4	3	JIC-G105549	32.58
STEERING		1PC		I-U-10	1-1/4	2-1/8	JIC-A43296	14.29
		1PC		P-U-10	1-1/4	2-1/8	JIC-G101021	15.07
		1PC		P-U-10	1-1/4	2-1/8	JIC-G34819	22.48
MODEL 680G, 680H								
BACKHOE BOOM		1PC		P-UB-10	2-1/4	4	JIC-G105556	33.28
BACKHOE BUCKET		1PC		P-UB-10	2-1/4	4	JIC-G105556	33.28
BACKHOE DIPPER		2PC		P-UB-9	2-1/2	4-1/2	JIC-G105513	49.19
BACKHOE DIPPER EXT		1PC		P-UB-10	1-1/2	3	JIC-G105548	25.60
BACKHOE STABILIZER		2PC		P-UB-9	2	4-1/2	JIC-G105525	38.20
BACKHOE SWING		1PC		P-UB-10	2	4	JIC-1543273C1	52.46
LOADER CLAM		1PC		P-UB-10	1-1/2	3	JIC-G105548	25.60
LOADER LIFT		1PC		P-UB-10	2	3-1/2	JIC-G105546	28.82
LOADER TILT		1PC		P-UB-10	1-3/4	3	JIC-G105549	32.58
STEERING		1PC		P-U-10	1-1/4	2-1/8	JIC-G34819	22.48
MODEL 680K								
BACKHOE BOOM		1PC		P-UB-10	2-1/4	4	JIC-G109505	30.56
BACKHOE BUCKET		1PC		P-UB-10	2-1/4	4	JIC-G109505	30.56
BACKHOE DIPPER		2PC		P-UB-9	2-1/2	4-1/2	JIC-G109498	45.37
BACKHOE DIPPER EXT		1PC		P-UB-10	1-1/2	3	JIC-G109452	19.44
BACKHOE SWING		1PC		P-UB-10	2	4	JIC-1543273C1	52.46
LOADER CLAM		1PC		P-UB-10	1-1/2	3	JIC-G109452	19.44
LOADER LIFT		1PC		P-UB-10	2	3-1/2	JIC-G109453	28.82
LOADER TILT		1PC		P-UB-10	1-3/4	3	JIC-1543262C1	38.59
STEERING		1PC		P-U-10	1-1/4	2-1/8	JIC-G34819	22.48
MODEL 680L								
BACKHOE BOOM	1343567C1	1PC		P-UB-10	2-1/4	4	JIC-1346478C2	55.32
	G101256	1PC		P-UB-10	2-1/4	4	JIC-1543277C1	32.79
BACKHOE BUCKET	1343602C1	1PC		P-UB-10	2-1/4	4	JIC-1346478C2	55.32
	G103856	1PC		P-UB-10	2-1/4	4	JIC-1543277C1	32.79

Replacement Kits For

J.I. CASE

J.I. CASE

Wheeled Backhoe Loaders								
APPLICATION	CYL #	Piston	SERIAL #	CODE	ROD	BORE	KIT #	List \$
MODEL 680L								
BACKHOE DIPPER	1345994C1	1PC		P-UB-10	2-1/2	4-1/2	JIC-1343707C2	63.90
	G101348	2PC		P-UB-9	2-1/2	4-1/2	JIC-1543291C1	48.05
BACKHOE DIPPER EXT	1980375C1	1PC		P-UB-10	1-1/2	3	JIC-1543256C1	37.80
BACKHOE STABILIZER	1986853C1	1PC		P-UB-10	2	4-1/2	JIC-1986856C2	47.81
	G102276	2PC		P-UB-10	2	4-1/2	JIC-1543270C1	67.63
BACKHOE SWING	1978339C1	1PC		P-UB-10	2	4	JIC-1543269C1	47.99
LOADER CLAM	D143217	1PC		P-UB-10	2	4	JIC-D143215	19.74
LOADER LIFT	G103073	1PC	-->JJG007050523, 526, 540, 547 & UP	P-UB-10	2-1/4	4	JIC-1543277C1	32.79
	G103457	1PC	-->JJG0070547; except 423, 526, & 540	P-UB-10	2	3-1/2	JIC-1543274C1	36.95
LOADER TILT	G101220	1PC		P-UB-10	1-3/4	3	JIC-1543262C1	38.59
MODEL 780								
BACKHOE BOOM		2PC		P-UB-9	2-1/2	4-1/2	JIC-G105513	49.19
BACKHOE BUCKET		2PC	-->5500549	P-U-9	3	5	JIC-G32668	39.82
		2PC	5500550-UP	P-UB-9	3	5	JIC-G105531	46.07
BACKHOE DIPPER		2PC		P-UB-9	3	6	JIC-G105516	49.50
BACKHOE DIPPER EXT		1PC		P-UB-10	2-1/4	4	JIC-G105556	33.28
		2PC		P-UB-9	2-1/2	4	JIC-G34636	33.71
BACKHOE STABILIZER		2PC		P-UB-9	2-1/2	4-1/2	JIC-G105513	49.19
BACKHOE SWING		2PC		P-UB-9	2-1/4	4-1/2	JIC-G105520	47.70
LOADER CLAM		2PC		P-U-9	2	4	JIC-G32299	29.21
		1PC		P-UB-10	2	4	JIC-1543273C1	52.46
LOADER HYDRA-LEVELING		2PC		P-UB-9	2	4	JIC-G105517	29.71
LOADER LIFT		2PC		P-UB-9	2-1/4	4-1/2	JIC-G105520	47.70
LOADER TILT		2PC		P-U-9	1-3/4	3-1/2	JIC-G105508	31.80
		2PC		P-U-9	1-3/4	3-1/2	JIC-G32228	26.07
MODEL 780B								
BACKHOE BOOM		1PC	ALL	P-UB-10	2-1/2	4-1/2	JIC-G105560	33.60
BACKHOE BUCKET		1PC	ALL	P-UB-10	2-1/2	4-1/2	JIC-G105560	33.60
BACKHOE DIPPER		1PC		P-UB-10	2-3/4	5	JIC-G105562	48.00
BACKHOE DIPPER EXT		1PC		P-UB-10	1-1/2	3	JIC-G105548	25.60
BACKHOE STABILIZER		1PC		P-UB-10	2-1/4	4-1/2	JIC-G105557	42.87
BACKHOE SWING		1PC		P-UB-10	2	4	JIC-1543273C1	52.46
LOADER CLAM		1PC		P-UB-10	2	4	JIC-1543273C1	52.46
LOADER LIFT		1PC		P-UB-10	2-1/4	4	JIC-G105556	33.28
LOADER TILT		1PC		P-UB-10	2	3-1/2	JIC-G105546	28.82
STEERING		1PC		P-U-10	1-1/4	2-1/8	JIC-G34819	22.48



REPLACEMENT KITS FOR J.I. CASE EQUIPEMENT

IMPORTANT - PLEASE READ

If a kit part number is unknown, the machine model number, serial number, and cylinder application will help identify the repair kit you need.

Example: Model Number **580C**
 Serial Number **5411021**
 Cylinder Application **Backhoe Swing**

If none of the above information is known, size and description of the parts needed will almost always be sufficient.

Kit Number	Code (Pg. x)	Rod X Bore Size	List Price
JIC-907001	TRACK ADJUSTER		\$ 16.75
JIC-A43296	I-U-10	1-1/4 X 2-1/8	14.29
JIC-A44644	I-O-3	3/4 X 1-1/2	6.81
JIC-D143215	I-U-10	2 X 4	19.74
JIC-D148100	I-U-13	3/4 X 1-1/2	10.25
JIC-D37360	I-U-9	1-1/2 X 2-1/2	18.42
JIC-D37361	I-U-9	1-1/2 X 2	16.85
JIC-D42867	I-U-1	1-1/4 ROD	10.76
JIC-D42869	I-U-1	1-1/2 ROD	13.52
JIC-D42870	I-U-1	1-1/2 ROD	13.42
JIC-D42872	I-U-1	1-3/4 ROD	10.05
JIC-D42873	I-U-1	1-3/4 ROD	13.78
JIC-D42874	I-U-1	2 ROD	9.05
JIC-D42875	I-U-1	1-3/4 ROD	10.67
JIC-D42876	I-U-1	2 ROD	9.31
JIC-D42877	I-U-1	2-1/4 ROD	9.97
JIC-D42878	P-U-1	2-1/4 ROD	12.24
JIC-D47651	I-U-1	2 ROD	9.52
JIC-D47896	I-U-1	1-1/2 ROD	10.83
JIC-D50279	I-U-9	3 X 5	32.09
JIC-D61006	P-U-10	1 X 2	5.06
JIC-D83184	I-U-11	3/4 X 1-1/2	10.25
JIC-G101021	P-U-10	1-1/4 X 2-1/8	15.07
JIC-G102401	USE JIC-G105545		
JIC-G102402	USE JIC-G105546		
JIC-G102403	USE JIC-G105547		
JIC-G102404	USE JIC-G105548		
JIC-G102405	USE JIC-G105549		
JIC-G102406	USE JIC-G105550		
JIC-G102407	USE JIC-G105551		
JIC-G102408	P-U-10	1-3/4 X 4	29.55
JIC-G102410	P-U-10	1-3/4 X 3-1/2	27.83
JIC-G102411	USE JIC-G105555		
JIC-G102412	USE JIC-G105556		
JIC-G105206	P-UB-10	1-1/2 X 2-3/4	29.45
JIC-G105502	P-UB-10	1-1/2 X 3	24.86
JIC-G105503	P-UB-9	1-1/2 X 2	24.38
JIC-G105505	P-UB-9	1-1/2 X 2-1/2	19.89
JIC-G105507	P-UB-10	1-1/4 X 2-1/2	17.28
JIC-G105508	P-U-9	1-3/4 X 3-1/2	31.80

Kit Number	Code (Pg. x)	Rod X Bore Size	List Price
JIC-G105510	P-UB-10	1-1/4 X 3	\$ 17.67
JIC-G105512	P-UB-9	1-1/2 X 3	29.35
JIC-G105513	P-UB-9	2-1/2 X 4-1/2	49.19
JIC-G105514	P-UB-9	2-1/2 X 5-1/2	42.50
JIC-G105515	P-UB-9	2-1/2 X 5	40.25
JIC-G105516	P-UB-9	3 X 6	49.50
JIC-G105517	P-UB-9	2 X 4	29.71
JIC-G105518	P-U-9	1-3/4 X 3-1/2	29.21
JIC-G105519	P-UB-9	1-3/4 X 4	28.02
JIC-G105520	P-UB-9	2-1/4 X 4-1/2	47.70
JIC-G105521	P-UB-9	2 X 3-1/2	28.09
JIC-G105523	P-UB-9	1-3/4 X 3	28.09
JIC-G105524	P-UB-9	1-3/4 X 3	32.34
JIC-G105525	P-UB-9	2 X 4-1/2	38.20
JIC-G105526	P-UB-9	2 X 4	30.90
JIC-G105527	P-UB-9	2 X 3-1/2	32.20
JIC-G105528	P-UB-8	1-3/4 X 3-1/4	28.09
JIC-G105529	P-UB-9	1-3/4 X 3-1/2	27.40
JIC-G105530	P-UB-9	2-1/4 X 5	47.75
JIC-G105531	P-UB-9	3 X 5	46.07
JIC-G105545	P-UB-10	2 X 4	32.58
JIC-G105546	P-UB-10	2 X 3-1/2	28.82
JIC-G105547	P-UB-10	1-3/4 X 3-1/4	29.44
JIC-G105548	P-UB-10	1-1/2 X 3	25.60
JIC-G105549	P-UB-10	1-3/4 X 3	32.58
JIC-G105550	P-UB-10	1-1/2 X 2-1/2	19.21
JIC-G105551	P-UB-10	1-1/4 X 2-1/2	21.77
JIC-G105552	P-UB-10	1-3/4 X 4	30.68
JIC-G105553	P-UB-10	2 X 3-1/4	32.28
JIC-G105555	P-UB-10	1-1/2 X 3-1/2	24.09
JIC-G105556	P-UB-10	2-1/4 X 4	33.28
JIC-G105557	P-UB-10	2-1/4 X 4-1/2	42.87
JIC-G105560	P-UB-10	2-1/2 X 4-1/2	31.98
JIC-G105561	P-UB-10	2-1/2 X 4	29.21
JIC-G105562	P-UB-10	2-3/4 X 5	48.00
JIC-G105563	P-UB-10	2-1/2 X 3-1/2	32.25
JIC-G105566	P-UB-9	2-3/4 X 5-1/2	68.60
JIC-G109417	P-UB-10	1-3/4 X 3-1/4	29.44
JIC-G109418	P-UB-10	1-1/2 X 3	19.31
JIC-G109421	P-UB-9	2 X 4	22.54

REPLACEMENT KITS FOR J.I. CASE EQUIPEMENT

Kit Number	Code (Pg. x)	Rod X Bore Size	List Price
JIC-G109423	P-UB-10	2 X 4	\$ 32.58
JIC-G109424	P-UB-10	2-1/2 X 4	33.66
JIC-G109452	P-UB-10	1-1/2 X 3	19.44
JIC-G109453	P-UB-10	2 X 3-1/2	28.82
JIC-G109454	P-UB-9	2 X 3-1/2	21.40
JIC-G109456	P-UB-10	1-1/2 X 2-1/2	19.21
JIC-G109458	P-UB-10	1-1/2 X 2-1/2	15.37
JIC-G109460	P-UB-10	1-3/4 X 3	21.13
JIC-G109462	P-UB-9	1-3/4 X 3	20.09
JIC-G109465	P-UB-10	2 X 3-1/4	30.53
JIC-G109470	P-UB-9	1-3/4 X 3-1/2	25.25
JIC-G109471	P-UB-10	1-3/4 X 3-1/2	28.09
JIC-G109472	P-UB-10	1-1/2 X 3-1/2	26.56
JIC-G109475	P-UB-10	1-1/4 X 2-1/2	21.77
JIC-G109476	P-UB-10	1-1/4 X 2-1/2	20.94
JIC-G109484	P-UB-9	1-1/2 X 2-1/2	23.50
JIC-G109498	P-UB-9	2-1/2 X 4-1/2	45.37
JIC-G109499	P-UB-9	2-1/2 X 5`	53.06
JIC-G109500	P-UB-9	3 X 5-1/2	61.20
JIC-G109501	P-UB-9	2-1/4 X 5	44.18
JIC-G109502	P-U-9	3 X 5	45.44
JIC-G109503	P-U-10	2-1/2 X 4-1/2	28.81
JIC-G109504	P-UB-10	2-1/2 X 3-1/2	28.46
JIC-G109505	P-UB-10	2-1/4 X 4	30.56
JIC-G110045	P-U-10	1-1/2 X 2-3/4	29.21
JIC-G110046	P-UB-10	2-1/2 X 3-1/2	28.21
JIC-G110047	P-UB-10	1-1/4 X 2-3/4	21.20
JIC-G110048	P-UB-10	1-1/4 X 3	20.02
JIC-G110049	P-UB-10	1-3/4 X 3	25.23
JIC-G110050	P-UB-10	1-1/2 X 3	22.26
JIC-G110053	P-UB-10	1-3/4 X 3-1/4	23.14
JIC-G110055	P-UB-10	1-1/4 X 2-1/2	32.84
JIC-G110526	P-UB-10	3 X 6	59.23
JIC-G110537	P-UB-10	2 X 4-1/4	31.27
JIC-G110582	P-UB-10	2-1/2 X 5	34.15
JIC-G110583	P-UB-10	2-1/4 X 5	82.01
JIC-G110621	P-UB-10	1-3/4 X 3-1/2	26.27
JIC-G32184	P-U-9	2-1/2 X 5	34.45
JIC-G32228	P-U-9	1-3/4 X 3-1/2	26.07
JIC-G32293	P-U-9	2 X 3-1/2	26.40
JIC-G32294	P-U-9	1-1/2 X 2-1/2	20.22
JIC-G32295	P-U-9	1-1/4 X 2-1/2	19.66
JIC-G32299	P-U-9	2 X 4	29.21
JIC-G32616	P-U-9	2 X 4	26.97
JIC-G32617	P-U-9	1-3/4 X 4	28.09
JIC-G32668	P-U-9	3 X 5	39.82
JIC-G32695	P-U-9	2 X 4-1/2	39.33
JIC-G32696	P-U-9	2-1/4 X 5	37.64
JIC-G32827	USE JIC-G105505		
JIC-G33141	USE JIC-G105507		

Kit Number	Code (Pg. x)	Rod X Bore Size	List Price
JIC-G33823	P-U-9	2-1/2 X 5-1/2	\$ 35.71
JIC-G34172	USE JIC-G105507		
JIC-G34205	USE JIC-G105510		
JIC-G34277	USE JIC-G109458		
JIC-G34332	USE JIC-G105512		
JIC-G34333	USE JIC-G105513		
JIC-G34334	P-U-9	3 X 5	49.10
JIC-G34335	P-U-9	2 X 4	27.53
JIC-G34536	USE JIC-G105514		
JIC-G34537	USE JIC-G105515		
JIC-G34569	USE JIC-G105516		
JIC-G34594	P-U-9	2 X 4	27.85
JIC-G34622	P-U-9	1-3/4 X 3-1/2	29.21
JIC-G34624	P-U-9	1-3/4 X 3-1/2	28.09
JIC-G34626	P-U-9	1-3/4 X 4	30.34
JIC-G34628	USE JIC-G105520		
JIC-G34630	USE JIC-G105521		
JIC-G34631	P-U-9	1-3/4 X 3-1/2	28.09
JIC-G34634	USE JIC-G105523		
JIC-G34636	P-U-9	2-1/4 X 4	33.71
JIC-G34642	USE JIC-G105524		
JIC-G34643	P-U-9	1-3/4 X 3	25.84
JIC-G34644	USE JIC-G105525		
JIC-G34646	P-U-9	1-1/2 X 3.5	25.28
JIC-G34647	USE JIC-G105526		
JIC-G34648	P-U-9	2 X 3-1/2	29.78
JIC-G34651	USE JIC-G105527		
JIC-G34652	P-U-9	1-1/2 X 3-1/2	25.71
JIC-G34653	USE JIC-G105528		
JIC-G34655	P-U-9	1-3/4 X 3-1/2	26.40
JIC-G34656	P-U-10	1-1/2 X 3	23.60
JIC-G34752	USE JIC-G105530		
JIC-G34753	USE JIC-G105531		
JIC-G34807	P-U-10	1 X 2-1/2	10.81
JIC-G34819	P-U-10	1-1/4 X 2-1/8	15.51
JIC-G34827	P-U-9	2-1/4 X 4	33.71
JIC-G35374	P-U-10	1 X 3	16.47
JIC-G35378	P-U-10	1 X 2-1/2	10.43
JIC-H52704	P-OB-3	1 X 2	10.54
JIC-H53041	P-OB-1	3-3/4 Rod Kit	14.32
JIC-N14638	P-U-10	1 X 2	22.26
JIC-N14639	P-U-10	1-1/4 X 2	27.31
JIC-S300163	I-U-10	2 X 4	15.17
JIC-S301013	I-U-10	2-1/2 X 5	36.18
JIC-S301442	I-U-10	2 X 4	23.06
JIC-S92713	P-U-9	2-1/2 X 5	33.57
JIC-S92714	P-U-9	2-1/2 X 5-1/2	35.82
JIC-S92724	P-U-9	2-3/4 X 5-1/2	47.57
JIC-110507A1	P-U-10	1-3/8 X 2	34.40
JIC-110510A1	P-U-10	1 X 2	34.40

REPLACEMENT KITS FOR J.I. CASE EQUIPEMENT

Kit Number	Code (Pg. x)	Rod X Bore Size	List Price
JIC-122535A1	P-UB-10	2 X 4	\$ 55.76
JIC-128725A1	P-UB-10	1-1/2 X 2-1/2	18.66
JIC-128728A1	P-U-10	1-1/4 X 2-1/2	15.79
JIC-131750A2	P-UB-10	2-1/4 X 3-1/4	40.76
JIC-1343707C2	P-UB-10	2-1/2 X 4-1/2	44.06
JIC-1346357C2	P-UB-10	4 X 8	146.55
JIC-1346409C2	P-UB-10	1-1/2 X 2-3/4	43.08
JIC-1346478C2	P-UB-10	2-1/4 X 4	55.32
JIC-1542915C2	P-UB-10	2-1/2 X 5	39.33
JIC-1542919C2	P-UB-10	2-1/4 X 5	89.00
JIC-1542923C2	P-UB-10	2-1/2 X 3-1/2	41.61
JIC-1543249C1	P-UB-10	1-1/4 X 2-1/2	30.27
JIC-1543250C1	P-UB-10	1-1/4 X 2-1/2	24.07
JIC-1543252C1	P-UB-10	1-1/2 X 3	27.68
JIC-1543253C1	P-UB-10	1-1/2 X 2-1/2	28.25
JIC-1543254C1	P-UB-10	1-1/2 X 3-1/2	30.31
JIC-1543256C1	P-UB-10	1-1/2 X 3	26.07
JIC-1543260C1	P-UB-10	1-3/4 X 3-1/4	32.98
JIC-1543261C1	p-ub-10	1-3/4 x 3-1/2	30.32
JIC-1543262C1	P-UB-10	1-3/4 X 3	26.62
JIC-1543263C1	P-UB-9	1-3/4 X 3	34.82
JIC-1543264C1	P-UB-10	1-3/4 X 4	33.54
JIC-1543265C1	P-UB-10	1-3/4 X 3-1/4	32.98
JIC-1543266C1	P-UB-10	1-3/4 X 3-1/2	32.82
JIC-1543267C1	P-UB-10	1-3/4 X 3	32.23
JIC-1543268C1	P-UB-10	2 X 3-1/4	30.85
JIC-1543269C1	P-UB-10	2 X 4	33.09
JIC-1543270C1	P-UB-10	2 X 4-1/2	46.64
JIC-1543271C1	P-UB-9	2 X 4	25.97
JIC-1543273C1	P-UB-10	2 X 4	36.18
JIC-1543274C1	P-UB-10	2 X 3-1/2	36.95
JIC-1543275C1	P-UB-10	2 X 4-1/4	34.96
JIC-1543276C1	P-UB-9	2-1/4 X 4-1/2	54.25
JIC-1543277C1	P-UB-10	2-1/4 X 4	37.27
JIC-1543279C1	P-UB-10	2-1/4 X 4-1/2	37.07
JIC-1543289C2	P-UB-10	2-1/4 X 5	50.76
JIC-1543291C1	P-UB-8	2-1/2 X 4-1/2	48.05
JIC-1543294C1	P-UB-10	2-1/2 X 3-1/2	30.32
JIC-1543303C1	P-UB-10	3 X 6-1/2	97.72
JIC-1543305C1	P-UB-10	3 X 5	58.31

Kit Number	Code (Pg. x)	Rod X Bore Size	List Price
JIC-1543309C1	P-UB-10	3-1/2 X 7	\$ 102.09
JIC-1543313C1	P-UB-10	1-1/2 X 3	32.86
JIC-1543378C1	P-UB-9	1-1/2X3	44.50
JIC-1543383C1	P-UB-9	2 X 3-1/2	44.32
JIC-158846A1	P-UB-10	95 X 140 mm	236.32
JIC-160227A1	P-UB-10	105 X 150 mm	245.32
JIC-160577A1	P-UB-10	85 X 125 mm	165.10
JIC-160579A1	P-UB-10	100 X 135 mm	235.59
JIC-160581A1	P-UB-10	80 X 120 mm	153.39
JIC-161912A1	P-UB-10	80 X 115 mm	173.97
JIC-161913A1	P-UB-10	90 X 125 mm	207.78
JIC-161914A1	P-UB-10	75 X 105 mm	182.65
JIC-162976A1	P-UB-10	70 X 95 mm	160.36
JIC-164183A1	P-UB-10	85 X 125 mm	164.36
JIC-164493A1	P-UB-10	75 X 100 mm	114.61
JIC-164494A1	P-UB-10	80 X 115 mm	183.32
JIC-175251A1	P-UB-10	1-1/2 X 2-3/4	42.34
JIC-179011A1	P-UB-10,12	2-1/2 X 5-1/2	91.16
JIC-182218A1	P-UB-10,12	2-1/4 X 4-1/2	58.69
JIC-183286A1	P-U-10	1-1/4 X 2-1/2	30.03
JIC-191747A1	P-UB-10,12	2 X 3-3/4	55.85
JIC-1980161C1	P-UB-10	2 X 3-1/2	34.05
JIC-1980181C2	P-UB-10	2 X 3-3/4	37.69
JIC-1980412C2	P-UB-10	2-1/2 X 5-1/2	118.74
JIC-198376A2	P-UB-10	1-3/4 X 2-1/2	32.86
JIC-1986823C2	P-UB-10	3-1/2 X 6	97.52
JIC-1986856C2	P-UB-10	2 X 4-1/2	47.81
JIC-1986920C2	P-UB-10	4 X 7	112.36
JIC-1994527C2	P-UB-10	2-3/4 X 5-1/2	115.44
JIC-234844A1	P-UB-10,12	2-1/4 X 4-1/4	60.92
JIC-235933A1	P-U-10	1-3/4 X 3-1/2	20.41
JIC-55355C91	I-OB-10	1 X 2-1/2	45.78
JIC-700710260	P-U-10	1-3/8 X 3	50.59
JIC-907001	P-N-5	2 X 2	16.75



REPLACEMENT PARTS FOR J.I. CASE EQUIPEMENT

NOTE: J.I. Case part numbers are used as a reference only. We do not imply that these kits are original REPLACEMENT PARTS.

U-SEALS

Part Number	Rod Diameter	List Price
JIC-G34803	1	\$ 3.59
JIC-G35372	1	3.25
JIC-D36968	1-1/4	3.77
JIC-D60999	1-1/4	3.96
JIC-H436694	1-3/8	4.59
JIC-D36969	1-1/2	4.25
JIC-G107921	1-1/2	7.79
JIC-1542999C1	1-3/4	8.77
JIC-D36970	1-3/4	4.85
JIC-G107922	1-3/4	5.45
JIC-D36971	2	5.30
JIC-G107923	2	10.08
JIC-1986572C1	2-1/4	6.12
JIC-D39359	2-1/4	6.12
JIC-D45571	2-1/2	6.90
JIC-S220100	2-3/4	7.29
JIC-D45572	3	7.65
JIC-A137343	3-1/2	8.99
JIC-S118038	3-1/2	25.81

PISTON SEALS

Part Number	Bore Diameter	List Price
JIC-D60995	2	\$ 3.03
JIC-A61430	2-1/8	5.70
JIC-191319A1	2-1/2	10.24
JIC-G100712	2-1/2	15.32
JIC-G102289	2-1/2	6.05
JIC-G33140	2-1/2	5.42
JIC-258546A2	2-3/4	12.84
JIC-G102288	3	15.77
JIC-G32034	3	8.85
JIC-H120188	3	3.39
JIC-G102287	3-1/4	14.01
JIC-G1340764C1	3-3/4	14.17
JIC-G100709	3-1/2	6.92
JIC-G102286	3-1/2	13.55
JIC-G102285	4	14.01
JIC-G110531	4-1/4	15.43
JIC-G101994	4-1/2	14.72
JIC-S228607	6-1/2	24.50

WIPERS

Part Number	Rod Diameter	List Price
JIC-193965C91	2-3/4	\$ 10.11
JIC-226847A1	1-3/8	8.70
JIC-403845R1	1-3/4	9.50
JIC-A44651	3/4	.76
JIC-D27380	2	4.71
JIC-D27432	1-3/4	3.41
JIC-D27705	1-1/4	3.79
JIC-D27706	1-1/2	1.55
JIC-D39360	2-1/4	2.81
JIC-D43162	2-1/4	2.81
JIC-D46180	3	3.37
JIC-D60997	1	1.78
JIC-D95141	1-1/4	8.60
JIC-D95142	1-1/2	8.78
JIC-D95143	1-3/4	9.50
JIC-D95144	2	9.85
JIC-D95145	2-1/4	10.54
JIC-D95146	2-1/2	11.93
JIC-D95148	3	13.90
JIC-D95149	2-3/8	9.05
JIC-H215202	2-3/4	4.79
JIC-H436692	1-3/8	2.31
JIC-H746297	1	2.55
JIC-L104363	3-1/4	12.79
JIC-S108245	4	26.10
JIC-S92653	3-1/2	18.53
JIC-S97854	3-1/2	18.53

BUFFER RINGS

Part Number	Rod Diameter	List Price
JIC-1542998C1	1-3/4	\$ 11.41
JIC-G109094	1-3/4	3.90
JIC-G107998	2-1/2	5.19



WEAR RINGS

Part Number	O.D. X Width	List Price
JIC-G102864	1-3/8 X 0.98	\$ 5.34
JIC-G102424	1-5/8 X 0.98	3.68
JIC-G102425	1-7/8 X 0.98	3.75
JIC-G101837	2-1/8 X 3/8	2.55
JIC-G34818	2-1/8 X 3/8	2.55
JIC-G101533	2-1/8 X 0.98	3.90
JIC-G102426	2-1/4 X 1.48	7.84
JIC-G1346476C1	2-3/8 X 0.98	2.81
JIC-G100714	2-1/2 X 3/8	2.64
JIC-G34805	2-1/2 X 3/8	2.64
JIC-G109908	2-5/8 X 0.98	2.73
JIC-G102427	2-5/8 X 1.48	6.99
JIC-G105187	2-3/4 X 3/8	2.68
JIC-G102428	2-7/8 X 1.48	7.21
JIC-H436691	3 X 1/4	2.46
JIC-G100449	3 X 3/8	2.73
JIC-G32033	3 X 3/8	2.73
JIC-G102429	3-1/8 X 1.48	8.38
JIC-S109445	3-1/4 X 3/8	2.79
JIC-G100711	3-1/2 X 3/8	2.81
JIC-S104133	3-3/4 X 1/2	2.86
JIC-G100448	4 X 3/8	3.57
JIC-A63393	4 X 5/8	3.35
JIC-G101996	4-1/2 X 3/4	3.43
JIC-S97856	6-1/2 X 1/2	3.95

O-RINGS

Part Number	Min. Pkg	List Price
JIC-22409R1	10	\$.43
JIC-235-5234	10	.53
JIC-238-5115	50	.11
JIC-238-5116	50	.11
JIC-238-5210	25	.21
JIC-238-5214	20	.21
JIC-238-5224	20	.30
JIC-238-5226	20	.32
JIC-238-5228	20	.38
JIC-238-5230	10	.43

REPLACEMENT PARTS FOR J.I. CASE

NOTE: J.I. Case part numbers are used as a reference only. We do not imply that these kits are original REPLACEMENT PARTS.

O-RINGS

Part Number	Min. Pkg	List Price
JIC-238-5232	10	\$.43
JIC-238-5234	10	.53
JIC-238-5437	2	2.29
JIC-238-6218	19	.24
JIC-238-6231	12	.46
JIC-238-7113	15	.25
JIC-A14515	20	.32
JIC-A17526	50	.11
JIC-A23316	4	1.08
JIC-A27365	50	.11
JIC-A27384	4	1.35
JIC-A27410	50	.11
JIC-A27507	10	.82
JIC-A27510	4	1.08
JIC-A27994	10	.53
JIC-A28239	2	1.89
JIC-A28318	10	.43
JIC-A29456	20	.21
JIC-A30095	10	.53
JIC-A30097	20	.24
JIC-A30915	20	.24
JIC-A55800	4	1.52
JIC-A60212	20	.30
JIC-A61429	20	.30
JIC-A7156	20	.30
JIC-A7982	20	.21
JIC-D26115	20	.32
JIC-D26820	20	.15
JIC-D27878	20	.30
JIC-D36183	4	1.35
JIC-D42453	3	2.25
JIC-F62075	20	.21
JIC-G100444	13	.70
JIC-G100710	13	.80
JIC-G100713	13	.61
JIC-G10347	4	1.33
JIC-G105104	4	1.97
JIC-G105183	4	1.61
JIC-G15457	10	.65
JIC-G46889	10	.53
JIC-H436690	10	.49
JIC-H743591	10	.64
JIC-N13688	12	.46
JIC-T52486	19	.32

VEE SETS

Part Number	O.D.	List Price
SINGLE ACTING VEE SETS WITH NO CENTER BEARING		
JIC-G33186	3-1/4	\$ 7.58
JIC-D47205	4-1/2	14.61
JIC-D47207	5-1/2	13.17
JIC-SVS5.5P	5-1/2	13.17
JIC-D49321	6	13.65
JIC-SVS6.0P	6	13.65
DOUBLE ACTING VEE SETS WITH CENTER BEARING		
JIC-G33201	2	\$ 10.34
JIC-G33193	2-1/2	10.85
JIC-G33151	3	11.12
JIC-G33237	3-1/2	12.32
JIC-G33239	4	13.44
JIC-DTVS4.5P	4-1/2	26.62
JIC-D36906	5	24.77
JIC-D47206	5	24.77

BACK-UP RINGS

Part Number	Min. Pkg.	List Price
JIC-A35884	13	\$.39
JIC-A45035	18	.28
JIC-A62070	8	.72
JIC-B92639	3	2.12
JIC-D28497	1	1.28
JIC-D28498	1	2.29
JIC-D28499	1	1.11
JIC-D28500	1	2.47
JIC-D38858	6	.89
JIC-D39539	1	1.49
JIC-D42453	3	2.25
JIC-G109033	2	3.16
JIC-G109297	10	.72
JIC-G109298	7	.82
JIC-G109300	4	1.58

BACK-UP RINGS

Part Number	Min. Pkg.	List Price
JIC-G32105	3	\$ 2.08
JIC-G32122	6	.89
JIC-G32126	5	1.04
JIC-G32129	7	.82
JIC-G32176	5	1.29
JIC-G32284	3	1.80
JIC-G32626	9	.59
JIC-G32649	2	3.07
JIC-G34260	3	2.61
JIC-H745760	7	.82
JIC-H754606	6	.82
JIC-S92644	3	2.36
JIC-S99881	2	3.13



REPLACEMENT SEAL KITS FOR JOHN DEERE EQUIPMENT*

Replacement Seal Kits By Machine Type

Table of Contents

Machine Type		Page
Bulldozers / Crawler Loaders	350, 350B, 350C, 350D, 355D, 450, 450B, 450C, 450D, 450E, 455D, 455E, 450G Bulldozer, 455G Crawler Loader, 550 Bulldozer, 550A, 550B Bulldozer, 550G Crawler Loader, 555 Crawler Loader, 555A, 555B Crawler Loader, 555G Crawler Loader, 650G Bulldozer, 655 Crawler Loader, 655B Crawler , Loader, 750B, 850, 850B	344 - 353
Compactors	646, 646B, 646C	354
Crawler Excavators	70, 70D, 80, 110, 120, 160 LC, 190E, 200 LC, 230 LC, 270 LC, 290D, 330 LC, 370, 450 LC, 490D, 490E, 495D, 590D, 595, 595D, 690, 690A, 690B, 690C, 690CR, 690D, 690E, 690E LC, 790, 790D, 790E LC, 792, 792D, 792D LC, 890, 890A, 892D, 892D LC, 892E, 892E LC, 990, 992D, 992D LC, 992E, 992E LC	354 - 363
Feller Bunchers	493D, 653E, 693B, 693C, 693D, 743,743A Tree Harvesters, 793D, 853	363 - 365
Loader Backhoes	300B, 302A, 310, 310A, 310B, 310C, 310D, 401C, 401D, 410, 410B, 410C, 410D, 415B, 500A, 500B, 500C, 510, 510B, 510C, 510D, 515B, 610B, 610C, 710B, 710C, 710D	365 - 378
Loaders - Articulated	344E, 444, 444C, 444CH, 444D, 444E, 544, 544A, 544B, 544C, 544D, 544E, 544E LL, 544E TC, 544G, 544H, 544H LL, 624E, 624G, 644, 644A, 644B, 644C, 644D, 644E, 644ER, 644G, 744E, 844, TC54H	378 - 383
Loaders - Wheeled	300, 400, 401A	383 - 384
Motor Graders	570, 570A, 570B, 670,670A,670B,672A,672B, 770,770A,770B,772A,772B	384 - 385
Scrapers	760, 760A, 762,762A,762B, 860,860A,860B, 862, 862B, 5010	385 - 386
Skidders	340D, 440, 440A, 440B, 440C Skidders/Grapple Skidders, 440D, 448 Skidders/Grapple Skidders, 540, 540A, 540B, 540D, 548D Grapple Skidders, 640, Skidders/Grapple Skidders, 640D, 648D Grapple Skidders, 740, 740A, 3605 Grapple Skidders	386 - 388
Alpha-Numeric Kit Listing		389 - 392
John Deere Individual Parts		392 - 394



KINGSEAL CO., LTD. THAILAND

46/152-153 Moo 3 Sri Saman Road
Baan Mai Pakkret, Nonthaburi Thailand 11120

Tel: +662 9617534 to 6

Fax: +662 9617540

Email: intlsales@kingseal.co.th / kingsealmail@gmail.com

Website: <http://www.kingseal.co.th>

All manufacturer's names, part numbers and descriptions are used for reference purposes only. We do not imply that any part shown is the product of these manufacturers. We also do not imply that the list price shown is exactly that of the manufacturer.

Replacement Kits For

JOHN DEERE

JOHN DEERE

Bulldozers/Crawler Loaders								
APPLICATION	CYL #	SERIAL #	CODE	ROD	BORE	KIT #	Arrangements	List \$
MODEL 350, 350B								
		Bulldozer Arrangement	6300, 6305, 6310					
		Ripper Arrangement	3100, 3110					
		Backhoe Arrangement	93, 93A, 95, 95A, 9250, 9300, 9550					
		Log Loader Arrangement	7702					
3 POINT HITCH		All	P-V-8	1-1/4	2-1/2	JD-AR105453		23.06
BACKHOE BOOM		-700717	P-V-8	2-1/4	4-1/2	JD-AR105355	9300	46.17
		700718-	P-V-14	2-1/4	4-1/2	JD-RE18764	9300	73.82
		-8249	P-V-8	2	4	JD-AR105387	9250	29.08
		8250-	P-V-8	2	4	JD-RE18732	9250, 9550	29.99
		All	P-V-8	2-1/4	4-1/2	JD-RE10640	93, 93A, 95, 95A	34.58
BACKHOE CROWD		-700717	P-V-8	2	4	JD-AR105387	93, 93A, 95, 95A, 9300	29.08
		700718-	P-V-14	2	4	JD-RE18741		63.25
		All	P-V-8	1-3/4	3-1/2	JD-RE18755	9250, 9550	25.40
BACKHOE STABILIZER		All	P-V-8	1-3/4	3-1/2	JD-RE18754	93, 93A, 9250, 9550	31.52
		All	P-V-8	2	4	JD-AR105387	9300	29.08
BACKHOE SWING		39797-	P-U-10	1-3/4	3-1/2	JD-RE18756	9550	31.35
		-8249	P-V-8	2	4	JD-AR105393	9250	36.76
		8250-	P-V-8	2	4	JD-RE18732	9250	29.99
BUCKHOE BUCKET	T60873 piston	-39796	P-U-10	1-3/4	3-1/2	JD-RE18756	9550	31.35
		-700717	P-V-8	2-1/4	3-1/2	JD-RE18757	93, 93A, 95, 95A, 9300	33.94
		700718-	P-V-14	2-1/4	3-1/2	JD-RE18758	9300	64.69
	All	P-V-8	1-3/4	3	JD-RE18751	9250, 9550	23.68	
DOZER ANGLE		YR. 1968-	P-V-8	1-1/4	3	JD-AR105454	6305	24.76
DOZER LIFT		YR. 1968-	P-V-8	1-1/4	3	JD-AR105454		24.76
DOZER TILT		59100-	P-V-8	1-1/4	2-1/2	JD-AR105453	6305	23.06
GRAPPLE		59100-	P-V-8	1-1/2	2-1/2	JD-RE19217		19.48
LOADER BOOM LIFT		All	P-V-8	2	4	JD-AR105387	Model 350 only	29.08
		All	P-V-8	2	3-3/4	JD-AR105381	Model 350B only	28.08
LOADER BUCKET TILT		All	P-V-8	1-1/2	2-3/4	JD-AR105430	Model 350 only	21.58
		All	P-V-8	1-1/2	2-3/4	JD-RE19222	Model 350B only	23.17
MULTI-PURPOSE		All	P-V-8	1-3/4	3	JD-RE18751		23.68
RIPPER		59100-	P-V-8	1-1/4	2-1/2	JD-AR105453		23.06
MODEL 350C								
		Bulldozer Arrangement	6300, 6305, 6310					
		Ripper Arrangement	3110					
		Backhoe Arrangement	93, 93A, 9250, 9300, 9550					
		Log Loader Arrangement	7702					
3 POINT HITCH		All	P-V-8	1-1/4	2-1/2	JD-AR105453		23.06
BACKHOE BOOM			P-V-8	2	4	JD-RE18732	9250, 9550	29.99
			P-V-8	2-1/4	4-1/2	JD-RE10640	93, 93A	34.58
		-700422	P-V-8	2-1/4	4-1/2	JD-AR105355	9300	46.17
		700423-	P-V-14	2-1/4	4-1/2	JD-RE18764	9300	73.82
		-700422	P-V-8	2-1/4	3-1/2	JD-RE18757	93, 93A, 9300	33.94
BACKHOE BUCKET		700423-	P-V-14	2-1/4	3-1/2	JD-RE18758	9300	64.69
		All	P-V-8	1-3/4	3	JD-RE18751	9250, 9550	23.68

LGP - Low Ground Pressure LT - Long Track SLF - Super Long Front STD - Straight Dozer WT - Wide Track

Replacement Kits For

JOHN DEERE

JOHN DEERE

Bulldozers/Crawler Loaders									
APPLICATION	CYL #	SERIAL #	CODE	ROD	BORE	KIT #	Arrangements	List \$	
MODEL 350C									
		Bulldozer Arrangement	6300, 6305, 6310						
		Ripper Arrangement	3110						
		Backhoe Arrangement	93, 93A, 9250, 9300, 9550						
		Log Loader Arrangement	7702						
BACKHOE CROWD		-700422	P-V-8	2	4	JD-AR105387	93, 93A, 9300	29.08	
		700423-	P-V-14	2	4	JD-RE18741	9300	63.25	
		All	P-V-8	1-3/4	3-1/2	JD-RE18755	9250, 9550	25.40	
BACKHOE STABILIZER		All	P-V-8	1-3/4	3-1/2	JD-RE18754	93, 93A, 9250, 9550	31.52	
		All	P-V-8	2	4	JD-AR105387	9300	29.08	
BACKHOE SWING		39797-	P-U-10	1-3/4	3-1/2	JD-RE18756		31.35	
		All	P-V-8	2	4	JD-RE18732	9250	29.99	
		T60873 piston	-39796	P-U-10	1-3/4	3-1/2	JD-RE18756	9550	31.35
DOZER ANGLE		All	P-V-8	1-1/4	3	JD-AR105454	6305	24.76	
DOZER LIFT		All	P-V-8	1-1/4	3	JD-AR105454		24.76	
DOZER TILT		All	P-V-8	1-1/4	2-1/2	JD-AR105453	6305	23.06	
GRAPPLE		All	P-V-8	1-1/2	2-1/2	JD-RE19217		19.48	
LOADER BOOM LIFT		All	P-V-8	2	3-3/4	JD-AR105381		28.08	
LOADER BUCKET TILT		All	P-V-8	1-1/2	2-3/4	JD-RE19222		23.17	
MULTI-PURPOSE		All	P-V-8	1-3/4	3	JD-RE18751		23.68	
RIPPER		All	P-V-8	1-1/4	2-1/2	JD-AR105453		23.06	
MODEL 350D, 355D									
		Bulldozer Arrangement	6305, 6310						
		Backhoe Arrangement	9300, 9550						
3 POINT HITCH		All	P-V-8	1-1/4	2-1/2	JD-AR105453		23.06	
BACKHOE BOOM		-700717	P-V-8	2-1/4	4-1/2	JD-AR105355	9300	46.17	
		700718-	P-V-14	2-1/4	4-1/2	JD-RE18764	9300	73.82	
		All	P-V-8	2	4	JD-RE18732	9550	29.99	
BACKHOE BUCKET		-700717	P-V-8	2-1/4	3-1/2	JD-RE18757	9300	33.94	
		700718-	P-V-14	2-1/4	3-1/2	JD-RE18758	9300	64.69	
		All	P-V-8	1-3/4	3	JD-RE18751	9550	23.68	
BACKHOE CROWD		-700717	P-V-8	2	4	JD-AR105387	9300	29.08	
		700718-	P-V-14	2	4	JD-RE18741	9300	63.25	
		All	P-V-8	1-3/4	3-1/2	JD-RE18755		25.40	
BACKHOE STABILIZER		All	P-V-8	1-3/4	3-1/2	JD-RE18754		31.52	
		All	P-V-8	2	4	JD-AR105387	9300	29.08	
		All	P-V-8	1-3/4	3-1/2	JD-RE18754	9550	31.52	
BACKHOE SWING		All	P-U-10	1-3/4	3-1/2	JD-RE18756	9550	31.35	
DOZER ANGLE		All	P-V-8	1-1/4	3	JD-AR105454	6305	24.76	
DOZER LIFT		All	P-V-8	1-1/4	3	JD-AR105454		24.76	
DOZER TILT		All	P-V-8	1-1/4	2-1/2	JD-AR105453	6305	23.06	
LOADER BOOM LIFT		All	P-V-8	2	3-3/4	JD-AR105381		28.08	
LOADER BUCKET TILT		All	P-V-8	1-1/2	2-3/4	JD-RE19222		23.17	
MULTI-PURPOSE		All	P-V-8	1-3/4	3	JD-RE18751		23.68	

LGP - Low Ground Pressure LT - Long Track SLF - Super Long Front STD - Straight Dozer WT - Wide Track

Replacement Kits For

JOHN DEERE

JOHN DEERE

Bulldozers/Crawler Loaders								
APPLICATION	CYL #	SERIAL #	CODE	ROD	BORE	KIT #	Arrangements	List \$
MODEL 450, 450B								
		Bulldozer Arrangement	6400, 6405, 6410, 6415					
		Ripper Arrangement	3100, 3110					
		Backhoe Arrangement	93, 93A, 95, 95A, 9250, 9300, 9550					
		Log Loader Arrangement	7712					
BACKHOE BOOM		-700717	P-V-8	2-1/4	4-1/2	JD-AR105355	9300	46.17
		700718-	P-V-14	2-1/4	4-1/2	JD-RE18764	9300	73.82
		-8249	P-V-8	2	4	JD-AR105387	9250	29.08
		8250-	P-V-8	2	4	JD-RE18732	9250, 9550	29.99
		All	P-V-8	2-1/4	4-1/2	JD-RE10640	93, 93A, 95, 95A	34.58
BACKHOE BUCKET		-700717	P-V-8	2-1/4	3-1/2	JD-RE18757	93, 93A, 95, 95A, 9300	33.94
		700718-	P-V-14	2-1/4	3-1/2	JD-RE18758	9300	64.69
		All	P-V-8	1-3/4	3	JD-RE18751	9250, 9550	23.68
BACKHOE CROWD		-700717	P-V-8	2	4	JD-AR105387	93, 93A, 95, 95A, 9300	29.08
		700718-	P-V-14	2	4	JD-RE18741	9300	63.25
		All	P-V-8	1-3/4	3-1/2	JD-RE18755	9250, 9550	25.40
BACKHOE STABILIZER		All	P-V-8	1-3/4	3-1/2	JD-RE18754	93, 93A, 9250, 9550	31.52
		All	P-V-8	2	4	JD-AR105387	9300	29.08
		All	P-V-8	1-3/4	3	JD-RE18751	95, 95A	23.68
BACKHOE SWING		39797-	P-U-10	1-3/4	3-1/2	JD-RE18756	9550	31.35
		-8249	P-V-8	2	4	JD-AR105393	9250	36.76
		8250-	P-V-8	2	4	JD-RE18732	9250	29.99
		T60873 piston	P-U-10	1-3/4	3-1/2	JD-RE18756	9550	31.35
DOZER ANGLE		All	P-V-8	1-1/2	3-1/2	JD-AR105432	6405	24.64
DOZER LIFT		All	P-V-8	1-1/2	3-1/2	JD-AR105432		24.64
DOZER TILT		4pc Piston Seal	N-N-14	-	4-1/2	JD-RE14094	6415	53.03
		4pc Piston Seal	P-V-1	2-1/4	-	JD-RE14208	6415	24.51
		Vee Set Piston Type	P-V-8	1-1/2	3-1/2	JD-AR105432	6405	24.64
		Vee Set Piston Type	P-V-8	2-1/4	4-1/2	JD-AR105355	6415	46.17
GRAPPLE		All	P-V-8	1-3/4	3-1/2	JD-RE18754		31.52
GRAPPLE CLAMP		All	P-V-8	2-1/4	5-1/4	JD-AR105346		39.11
LOADER BOOM LIFT		All	P-V-8	2-1/4	4-1/2	JD-RE10640	Model 450 only	34.58
		All	P-V-8	2-1/4	4-1/4	JD-RE18739	Model 450B only	37.37
LOADER BUCKET TILT		All	P-V-8	2	3-1/2	JD-AR105392	Model 450 only	25.46
		All	P-V-8	2	3-1/2	JD-RE18748	Model 450B only	30.37
MULTI-PURPOSE		All	P-V-8	2	4	JD-AR105387		29.08
RIPPER		59100-	P-V-8	1-1/4	2-1/2	JD-AR105453		23.06
MODEL 450C								
		Bulldozer Arrangement	6400, 6405, 6410, 6415					
		Ripper Arrangement	3110					
		Backhoe Arrangement	93, 93A, 95, 95A, 9250, 9300, 9550					
		Log Loader Arrangement	7712					
BACKHOE BOOM		-700385	P-V-8	2-1/4	4-1/2	JD-AR105355	9300	46.17
		700386-	P-V-14	2-1/4	4-1/2	JD-RE18764	9300	73.82

LGP - Low Ground Pressure LT - Long Track SLF - Super Long Front STD - Straight Dozer WT - Wide Track

Replacement Kits For

JOHN DEERE

JOHN DEERE

Bulldozers/Crawler Loaders								
APPLICATION	CYL #	SERIAL #	CODE	ROD	BORE	KIT #	Arrangements	List \$
MODEL 450C								
		Bulldozer Arrangement	6400, 6405, 6410, 6415					
		Ripper Arrangement	3110					
		Backhoe Arrangement	93, 93A, 95, 95A, 9250, 9300, 9550					
		Log Loader Arrangement	7712					
BACKHOE BOOM		All	P-V-8	2	4	JD-RE18732	9250, 9550	29.99
		All	P-V-8	2-1/4	4-1/2	JD-RE10640	93, 93A, 95, 95A	34.58
BACKHOE BUCKET		-700385	P-V-8	2-1/4	3-1/2	JD-RE18757	93, 93A, 95, 95A, 9300	33.94
		700386-	P-V-14	2-1/4	3-1/2	JD-RE18758	9300	64.69
		All	P-V-8	1-3/4	3	JD-RE18751	9250, 9550	23.68
BACKHOE CROWD		-700385	P-V-8	2	4	JD-AR105387	93, 93A, 95, 95A, 9300	29.08
		700386-	P-V-14	2	4	JD-RE18741	9300	63.25
		All	P-V-8	1-3/4	3-1/2	JD-RE18755		25.40
BACKHOE STABILIZER		All	P-V-8	1-3/4	3-1/2	JD-RE18754	93, 93A, 9250, 9550	31.52
		All	P-V-8	2	4	JD-AR105387	9300	29.08
		All	P-V-8	1-3/4	3	JD-RE18751	95, 95A	23.68
BACKHOE SWING		39797-	P-U-10	1-3/4	3-1/2	JD-RE18756	9550	31.35
		All	P-V-8	2	4	JD-RE18732	9250	29.99
	T60873 piston	-39796	P-U-10	1-3/4	3-1/2	JD-RE18756	9550	31.35
DOZER ANGLE		All	P-V-8	1-1/2	3-1/2	JD-AR105432	6405	24.64
DOZER LIFT		All	P-V-8	1-1/2	3-1/2	JD-AR105432		24.64
DOZER TILT		All	P-V-8	1-1/2	3-1/2	JD-AR105432	6405	24.64
		All	P-V-8	2-1/4	4-1/2	JD-AR105355	6415	46.17
		Field Replacement Check Piston	N-N-14	-	4-1/2	JD-RE14094	6415	53.03
		Field Replacement Check Piston	P-V-1	2-1/4	-	JD-RE14208	6415	24.51
GRAPPLE		All	P-V-8	1-3/4	3-1/2	JD-RE18754		31.52
GRAPPLE CLAMP		All	P-V-8	2-1/4	5-1/4	JD-AR105346		39.11
LOADER BOOM LIFT		All	P-V-8	2-1/4	4-1/4	JD-RE18739		37.37
LOADER BUCKET TILT		-205020	P-V-8	2	3-1/2	JD-RE18748		30.37
		205021-	P-V-8	1-3/4	3-1/2	JD-RE18754		31.52
MULTI-PURPOSE		All	P-V-8	2	4	JD-AR105387		29.08
RIPPER		All	P-V-8	1-1/4	2-1/2	JD-AR105453		23.06
MODEL 450D, 450E, 455D, 455E								
		Bulldozer Arrangement	6405, 6410, 6415					
		Backhoe Arrangement	9300, 9550					
BACKHOE BOOM		-700717	P-V-8	2-1/4	4-1/2	JD-AR105355	9300	46.17
		700718-	P-V-14	2-1/4	4-1/2	JD-RE18764	9300	73.82
		All	P-V-8	2	4	JD-RE18732	9550	29.99
BACKHOE BUCKET		-700717	P-V-8	2-1/4	3-1/2	JD-RE18757	9300	33.94
		700718-	P-V-14	2-1/4	3-1/2	JD-RE18758	9300	64.69
		All	P-V-8	1-3/4	3	JD-RE18751	9550	23.68
BACKHOE CROWD		-700717	P-V-8	2	4	JD-AR105387	9300	29.08
		700718-	P-V-14	2	4	JD-RE18741	9300	63.25

LGP - Low Ground Pressure LT - Long Track SLF - Super Long Front STD - Straight Dozer WT - Wide Track

Replacement Kits For

JOHN DEERE

JOHN DEERE

Bulldozers/Crawler Loaders								
APPLICATION	CYL #	SERIAL #	CODE	ROD	BORE	KIT #	Arrangements	List \$
MODEL 450D, 450E, 455D, 455E								
Bulldozer Arrangement			6405, 6410, 6415					
Backhoe Arrangement			9300, 9550					
BACKHOE CROWD		All	P-V-8	1-3/4	3-1/2	JD-RE18755	9550	25.40
BACKHOE STABILIZER		All	P-V-8	2	4	JD-AR105387	9300	29.08
		All	P-V-8	1-3/4	3-1/2	JD-RE18754	9550	31.52
BACKHOE SWING		All	P-U-10	1-3/4	3-1/2	JD-RE18756	9550	31.35
DOZER ANGLE		All	P-V-8	1-1/2	3-1/2	JD-AR105432	6405	24.64
DOZER LIFT		All	P-V-8	1-1/2	3-1/2	JD-AR105432		24.64
DOZER TILT		-712333	P-V-8	2-1/4	4-1/2	JD-AR105355	6415	46.17
		712334-	N-N-14	-	4-1/2	JD-RE14094	6415	53.03
		712334-	P-V-1	2-1/4	-	JD-RE14208	6415	24.51
		All	P-V-8	1-1/2	3-1/2	JD-AR105432	6405	24.64
GRAPPLE CLAMP		All	P-V-8	2-1/4	5-1/4	JD-AR105346		39.11
LOADER BOOM LIFT		All	P-V-8	2-1/4	4-1/4	JD-RE18739		37.37
LOADER BUCKET TILT		All	P-V-8	1-3/4	3-1/2	JD-RE18754		31.52
MULTI-PURPOSE		All	P-V-8	2	4	JD-AR105387		29.08
MODEL 450G Bulldozer								
DOZER ANGLE	AH149949	-846913	I,P-UB-1	40 mm		JD-AH149194		32.09
	AH149949	-846913	N-N-14		70 mm	JD-RE20428		27.43
	AH161764	All	I,P-UB-1	40 mm		JD-AH149194		32.09
	AH161764	All	N-N-10		70 mm	JD-RE37004		6.81
DOZER ANGLE (WT)	AH137776	All	N-N-14		80 mm	JD-AH149842		43.50
	AH137776	All	P-UB-1	45 mm		JD-RE20434		37.20
	AH149950	-846912	P-UB-1	45 mm		JD-AH149813		38.45
	AH149950	-846912	N-N-14		80 mm	JD-AH149842		43.50
	AH161770	846913-	P-UB-1	45 mm		JD-AH149813		38.45
	AH161770	846913-	N-N-10		80 mm	JD-RE37003		9.72
DOZER LIFT	AH150067	-790250	N-N-14		80 mm	JD-AH149842		43.50
	AH150067	-790250	P-UB-1	40 mm		JD-RE20433		37.00
	AH150067	-846999	I,P-UB-1	40 mm		JD-AH149194		32.09
	AH150067	-846999	N-N-14		80 mm	JD-AH149842		43.50
	AH161762	846843-	I,P-UB-1	40 mm		JD-AH149194		32.09
	AH161762	846843-	N-N-10		80 mm	JD-RE37003		9.72
	RE28350	-822042	N-N-14		80 mm	JD-AH149842		43.50
	RE28350	-822042	P-UB-1	40 mm		JD-RE20433		37.00
DOZER LIFT (WT) (LGP)	AH143026	790251-822042	N-N-14		80 mm	JD-AH149842		43.50
	AH143026	790251-822042	P-UB-1	40 mm		JD-RE20433		37.00
	AH150066	-846842	I,P-UB-1	40 mm		JD-AH149194		32.09
	AH150066	-846842	N-N-14		80 mm	JD-AH149842		43.50
	AH161767	847000-	I,P-UB-1	40 mm		JD-AH149194		32.09
	AH161767	847000-	N-N-10		80 mm	JD-RE37003		9.72
RIPPER	AU41772	59100-	P-V-8	1-1/4	2-1/2	JD-AR105453		23.06
TILT	AH151379	822043-846913	P-UB-1	45 mm		JD-AH149813		38.45
	AH151379	822043-846913	N-N-14		90 mm	JD-AH149843		43.14
	AH161772	846914-	N-N-10		90 mm	JD-AH134955		9.05
	AH161772	846914-	P-UB-1	45 mm		JD-AH149813		38.45
	RE35814	-822042	N-N-14		90 mm	JD-AH149843		43.14

LGP - Low Ground Pressure LT - Long Track SLF - Super Long Front STD - Straight Dozer WT - Wide Track

Replacement Kits For

JOHN DEERE

JOHN DEERE

Bulldozers/Crawler Loaders									
APPLICATION	CYL #	SERIAL #	CODE	ROD	BORE	KIT #	Arrangements	List \$	
MODEL 450G Bulldozer									
TILT	RE35814	-822042	P-UB-1	45 mm		JD-RE20434		37.20	
MODEL 455G Crawler Loader									
BUCKET CLAM	AH148714	All	P-UB-1	50 mm		JD-AH148164		27.72	
	AH148714	All	N-N-14		100 mm	JD-AH149844		54.45	
	RE25702	-822210	N-N-14		100 mm	JD-AH149844		54.45	
	RE25702	-822210	P-UB-1	50 mm		JD-RE20595		32.88	
	LOADER BOOM	AH134483	-760572	P-UB-1	50 mm		JD-RE20595		32.88
		AH134483	760573-823917	P-UB-1	56 mm		JD-RE31716		45.04
		AH134483	-823917	N-N-14		100 mm	JD-AH149844		54.45
LOADER BUCKET	AH150117	All	P-UB-1	56 mm		JD-AH149814		35.10	
	AH150117	All	N-N-14		100 mm	JD-AH149844		54.45	
	AH148736	All	P-UB-1	50 mm		JD-AH148164		27.72	
	AH148736	All	N-N-14		90 mm	JD-AH149843		43.14	
	RE28353	-802210	N-N-14		90 mm	JD-AH149843		43.14	
MULTI-PURPOSE	RE28353	-802210	P-UB-1	50 mm		JD-RE20595		32.88	
	AH148736	All	P-UB-1	50 mm		JD-AH148164		27.72	
	AH148736	All	N-N-14		90 mm	JD-AH149843		43.14	
RIPPER	RE28353	-802210	N-N-14		90 mm	JD-AH149843		43.14	
	RE28353	-802210	P-UB-1	50 mm		JD-RE20595		32.88	
	AU41772	59100-	P-V-8	1-1/4	2-1/2	JD-AR105453		23.06	
MODEL 550 Bulldozer									
		Bulldozer Arrangement	6405, 6410, 6415						
		Backhoe Arrangement	9300, 9550						
		Ripper Arrangement	3110						
BACKHOE BOOM		-700717	P-V-8	2-1/4	4-1/2	JD-AR105355	9300	46.17	
		700718-	P-V-14	2-1/4	4-1/2	JD-RE18764	9300	73.82	
BACKHOE BUCKET		All	P-V-8	2	4	JD-RE18732	9550	29.99	
		-700717	P-V-8	2-1/4	3-1/2	JD-RE18757	9300	33.94	
		700718-	P-V-14	2-1/4	3-1/2	JD-RE18758	9300	64.69	
BACKHOE CROWD		All	P-V-8	1-3/4	3	JD-RE18751	9550	23.68	
		-700717	P-V-8	2	4	JD-AR105387	9300	29.08	
BACKHOE STABILIZER		All	P-V-8	1-3/4	3-1/2	JD-RE18755	9550	25.40	
		All	P-V-8	2	4	JD-AR105387	9300	29.08	
BACKHOE SWING		All	P-V-8	1-3/4	3-1/2	JD-RE18754	9550	31.52	
		39797-	P-U-10	1-3/4	3-1/2	JD-RE18756	9550	31.35	
DOZER ANGLE		T60873 piston	-39796	P-U-10	1-3/4	3-1/2	JD-RE18756	9550	31.35
		All	P-V-8	1-1/2	3-1/2	JD-AR105432	6405	24.64	
DOZER LIFT		All	P-V-8	1-1/2	3-1/2	JD-AR105432		24.64	
DOZER TILT		All	P-V-8	1-1/2	3-1/2	JD-AR105432	6405	24.64	
		All	P-V-8	2-1/4	4-1/2	JD-AR105355	6415	46.17	
RIPPER		Field Replacement Check Piston	N-N-14	-	4-1/2	JD-RE14094	6415	53.03	
		Field Replacement Check Piston	P-V-1	2-1/4	-	JD-RE14208	6415	24.51	
RIPPER		All	P-V-8	1-1/4	2-1/2	JD-AR105453		23.06	

LGP - Low Ground Pressure LT - Long Track SLF - Super Long Front STD - Straight Dozer WT - Wide Track

Replacement Kits For

JOHN DEERE

JOHN DEERE

Bulldozers/Crawler Loaders									
APPLICATION	CYL #	SERIAL #	CODE	ROD	BORE	KIT #	Arrangements	List \$	
MODEL 550A, 550B Bulldozer									
Bulldozer Arrangement			6405, 6410, 6415						
Backhoe Arrangement			9300, 9550						
BACKHOE BOOM		-700717	P-V-8	2-1/4	4-1/2	JD-AR105355	9300	46.17	
		700718-	P-V-14	2-1/4	4-1/2	JD-RE18764	9300	73.82	
		All	P-V-8	2	4	JD-RE18732	9550	29.99	
BACKHOE BUCKET		-700717	P-V-8	2-1/4	3-1/2	JD-RE18757	9300	33.94	
		700718-	P-V-14	2-1/4	3-1/2	JD-RE18758	9300	64.69	
		All	P-V-8	1-3/4	3	JD-RE18751	9550	23.68	
BACKHOE CROWD		-700717	P-V-8	2	4	JD-AR105387	9300	29.08	
		700718-	P-V-14	2	4	JD-RE18741	9300	63.25	
		All	P-V-8	1-3/4	3-1/2	JD-RE18755		25.40	
BACKHOE STABILIZER		All	P-V-8	2	4	JD-AR105387	9300	29.08	
		All	P-V-8	1-3/4	3-1/2	JD-RE18754	9550	31.52	
		All	P-U-10	1-3/4	3-1/2	JD-RE18756	9550	31.35	
BACKHOE SWING		All	P-V-8	1-1/2	3-1/2	JD-AR105432	6405	24.64	
DOZER ANGLE		All	P-V-8	1-1/2	3-1/2	JD-AR105432		24.64	
DOZER LIFT		-712333	P-V-8	2-1/4	4-1/2	JD-AR105355	6415	46.17	
DOZER TILT		712334-	N-N-14	-	4-1/2	JD-RE14094	6415	53.03	
		712334-	P-V-1	2-1/4	-	JD-RE14208	6415	24.51	
		All	P-V-8	1-1/2	3-1/2	JD-AR105432	6405	24.64	
MODEL 550G Crawler Loader									
DOZER ANGLE	AH137776	All	N-N-14		80 mm	JD-AH149842		43.50	
	AH137776	All	P-UB-1	45 mm		JD-RE20434		37.20	
	AH149950	-846912	P-UB-1	45 mm		JD-AH149813		38.45	
	AH149950	-846912	N-N-14		80 mm	JD-AH149842		43.50	
	AH161770	846913-	P-UB-1	45 mm		JD-AH149813		38.45	
	AH161770	846913-	N-N-10		80 mm	JD-RE37003		9.72	
	DOZER LIFT	AH150066	-846842	I,P-UB-1	40 mm		JD-AH149194		32.09
		AH150066	-846842	N-N-14		80 mm	JD-AH149842		43.50
		AH150067	-790250	N-N-14		80 mm	JD-AH149842		43.50
		AH150067	-790250	P-UB-1	40 mm		JD-RE20433		37.00
		AH150067	-846999	I,P-UB-1	40 mm		JD-AH149194		32.09
		AH150067	-846999	N-N-14		80 mm	JD-AH149842		43.50
AH161762		846843-	I,P-UB-1	40 mm		JD-AH149194		32.09	
AH161762		846843-	N-N-10		80 mm	JD-RE37003		9.72	
AH161767		847000-	I,P-UB-1	40 mm		JD-AH149194		32.09	
AH161767		847000-	N-N-10		80 mm	JD-RE37003		9.72	
TILT		AH151379	All	P-UB-1	45 mm		JD-AH149813		38.45
		AH151379	All	N-N-14		90 mm	JD-AH149843		43.14
	AH161772	846914-	N-N-10		90 mm	JD-AH134955		9.05	
	AH161772	846914-	P-UB-1	45 mm		JD-AH149813		38.45	
	RE35814	-822042	N-N-14		90 mm	JD-AH149843		43.14	
	RE35814	-822042	P-UB-1	45 mm		JD-RE20434		37.20	

LGP - Low Ground Pressure LT - Long Track SLF - Super Long Front STD - Straight Dozer WT - Wide Track

Replacement Kits For

JOHN DEERE

JOHN DEERE

Bulldozers/Crawler Loaders								
APPLICATION	CYL #	SERIAL #	CODE	ROD	BORE	KIT #	Arrangements	List \$
MODEL 555 Crawler Loader								
		Backhoe Arrangement	9300					
		Ripper Arrangement	3110					
		Log Loader Arrangement	7712					
BACKHOE BOOM		-700717	P-V-8	2-1/4	4-1/2	JD-AR105355	9300	46.17
		700718-	P-V-14	2-1/4	4-1/2	JD-RE18764	9300	73.82
BACKHOE BUCKET		-700717	P-V-8	2-1/4	3-1/2	JD-RE18757	9300	33.94
		700718-	P-V-14	2-1/4	3-1/2	JD-RE18758	9300	64.69
BACKHOE CROWD		-700717	P-V-8	2	4	JD-AR105387	9300	29.08
		700718-	P-V-14	2	4	JD-RE18741	9300	63.25
BACKHOE STABILIZER		All	P-V-8	2	4	JD-AR105387		29.08
GRAPPLE		All	P-V-8	1-3/4	3-1/2	JD-RE18754		31.52
GRAPPLE CLAMP		All	P-V-8	2-1/4	5-1/4	JD-AR105346		39.11
LOADER BOOM LIFT		-294037	I-U-8	2-1/4	4-1/4	JD-AH139418		33.21
		294038-	P-V-8	2-1/4	4-1/4	JD-RE18739		37.37
LOADER BUCKET TILT		All	P-V-8	1-3/4	3-1/2	JD-RE18754		31.52
MULTI-PURPOSE		All	P-V-8	2	4	JD-AR105387		29.08
RIPPER		All	P-V-8	1-1/4	2-1/2	JD-AR105453		23.06
MODEL 555A, 555B Crawler Loader								
		Backhoe Arrangement	9300					
		Ripper Arrangement	3110					
		Log Loader Arrangement	7712					
BACKHOE BOOM		-700717	P-V-8	2-1/4	4-1/2	JD-AR105355	9300	46.17
		700718-	P-V-14	2-1/4	4-1/2	JD-RE18764	9300	73.82
BACKHOE BUCKET		-700717	P-V-8	2-1/4	3-1/2	JD-RE18757	9300	33.94
		700718-	P-V-14	2-1/4	3-1/2	JD-RE18758	9300	64.69
BACKHOE CROWD		-700717	P-V-8	2	4	JD-AR105387	9300	29.08
		700718-	P-V-14	2	4	JD-RE18741	9300	63.25
BACKHOE STABILIZER		All	P-V-8	2	4	JD-AR105387		29.08
GRAPPLE CLAMP		All	P-V-8	2-1/4	5-1/4	JD-AR105346		39.11
LOADER BOOM LIFT		All	P-V-8	2-1/4	4-1/4	JD-RE18739		37.37
LOADER BUCKET TILT		All	P-V-8	1-3/4	3-1/2	JD-RE18754		31.52
MULTI-PURPOSE		All	P-V-8	2	4	JD-AR105387		29.08
MODEL 555G Crawler Loader								
BUCKET CLAM	AH148714	All	P-UB-1	50 mm		JD-AH148164		27.72
	AH148714	All	N-N-14		100 mm	JD-AH149844		54.45
	RE25702	-822210	N-N-14		100 mm	JD-AH149844		54.45
	RE25702	-822210	P-UB-1	50 mm		JD-RE20595		32.88
LOADER BOOM	AH150111	All	P-UB-1	63 mm		JD-AH149815		38.52
	AH150111	All	N-N-14		115 mm	JD-AH149846		76.78
	RE26632	-823917	N-N-14		115 mm	JD-AH149846		76.78
	RE26632	-823917	P-UB-1	63 mm		JD-RE28899		67.19
LOADER BUCKET	AH148715	All	P-UB-1	50 mm		JD-AH148164		27.72
	AH148715	All	N-N-14		100 mm	JD-AH149844		54.45
	RE26633	-818179	P-UB-1	50 mm		JD-AH148164		27.72
	RE26633	-818179	N-N-14		100 mm	JD-AH149844		54.45
MODEL 650G Bulldozer								
DOZER ANGLE			N-N-14		80 mm	JD-RE31138		34.36

LGP - Low Ground Pressure LT - Long Track SLF - Super Long Front STD - Straight Dozer WT - Wide Track

Replacement Kits For

JOHN DEERE

JOHN DEERE

Bulldozers/Crawler Loaders								
APPLICATION	CYL #	SERIAL #	CODE	ROD	BORE	KIT #	Arrangements	List \$
MODEL 650G Bulldozer								
DOZER ANGLE	AH137776	-822211	N-N-14		80 mm	JD-AH149842		43.50
	AH137776	-822211	P-UB-1	45 mm		JD-RE20434		37.20
	AH149950	-846912	P-UB-1	45 mm		JD-AH149813		38.45
	AH149950	-846912	N-N-14		80 mm	JD-AH149842		43.50
	AH161770	846913-	P-UB-1	45 mm		JD-AH149813		38.45
	AH161770	846913-	N-N-10		80 mm	JD-RE37003		9.72
DOZER LIFT			P-UB-1	40 mm		JD-RE20433		37.00
			N-N-14		80 mm	JD-RE31138		34.36
	AH143026	790251-822042	N-N-14		80 mm	JD-AH149842		43.50
	AH143026	790251-822042	P-UB-1	40 mm		JD-RE20433		37.00
	AH150066	847000-	I,P-UB-1	40 mm		JD-AH149194		32.09
	AH150066	847000-	N-N-10		80 mm	JD-RE37003		9.72
TILT	RE28350	-790250	N-N-14		80 mm	JD-AH149842		43.50
	RE28350	-790250	P-UB-1	40 mm		JD-RE20433		37.00
			N-N-14		100 mm	JD-RE31139		60.67
	AH149951	All	N-N-14		100 mm	JD-AH137687		45.59
	AH149951	All	P-UB-1	50 mm		JD-RE20595		32.88
	AH161766	All	P-UB-1	50 mm		JD-AH148164		27.72
	AH161766	All	N-N-10		100 mm	JD-AH161781		15.07
	RE35808	-822042	N-N-14		100 mm	JD-AH149844		54.45
	RE35808	-822042	P-UB-1	50 mm		JD-RE20595		32.88
	MODEL 655 Crawler Loader							
LOADER BOOM LIFT		All	P-U-8	3-3/4	5-1/2	JD-RE18763		57.09
LOADER BUCKET TILT		All	P-V-8	2-1/4	4-1/2	JD-AR105355		46.17
		Field Replacement Check Piston	N-N-14	-	4-1/2	JD-RE14094		53.03
		Field Replacement Check Piston	P-V-1	2-1/4	-	JD-RE14208		24.51
MULTI-PURPOSE			P-V-1	2-1/2		JD-RE17345		30.04
		All	P-V-8	2	4	JD-AR105387		29.08
	RE22315	All	N-N-14		5-1/2	JD-RE14102		79.82
TRACK ADJUSTER		All	I-U-4	3-3/4	3	JD-905001		36.46
MODEL 655B Crawler Loader								
LOADER BOOM LIFT		All	N-N-14		5-1/2	JD-RE15907		79.82
LOADER BUCKET TILT		All	P-U-1	3-3/4		JD-RE31528		47.27
		All	N-N-14	-	4-1/2	JD-RE14094		53.03
		All	P-V-1	2-1/4	-	JD-RE14208		24.51
MULTI-PURPOSE		All	N-N-14		5-1/2	JD-RE14102		79.82
		All	P-V-1	2-1/2		JD-RE17345		30.04
TRACK ADJUSTER		All	I-U-4	3-3/4	3	JD-905001		36.46
MODEL 750B								
ANGLE (Inside Dozer)	RE17343	-743282	N-N-14		6-1/4	JD-RE14022		86.50
DOZER LIFT	RE17343	-743282	P-V-1	2-3/4		JD-RE17342		40.90
	AH150118	779602-	P-UB-1	56 mm		JD-AH149814		35.10
	AH150118	779602-	N-N-14		100 mm	JD-AH149844		54.45
	AT101434	779602-	N-N-14		100 mm	JD-AH137687		45.59

LGP - Low Ground Pressure LT - Long Track SLF - Super Long Front STD - Straight Dozer WT - Wide Track

Replacement Kits For

JOHN DEERE

JOHN DEERE

Bulldozers/Crawler Loaders									
APPLICATION	CYL #	SERIAL #	CODE	ROD	BORE	KIT #	Arrangements	List \$	
MODEL 750B									
DOZER LIFT	AT101434	779602-	P-UB-1	56 mm		JD-RE31716		45.04	
	RE17453	-779601	N-N-14		4-1/4	JD-RE17458		54.06	
	RE17459	-743282	N-N-14		4-1/4	JD-RE17458		54.06	
	RE17462	All	N-N-14		4-1/4	JD-RE17458		54.06	
	RE35226	743283-	N-N-14		4-1/4	JD-RE17458		54.06	
	TILT	AH145297		N-N-14		160 mm	JD-AH137210		72.20
		AH145297		N-N-14		5-1/2	JD-RE14102		79.82
		AH145297		P-V-1	2-1/2		JD-RE17345		30.04
		AH145297		P-UB-1	80 mm		JD-RE25152		91.43
	TILT (Angle Dozer)	RE17344		N-N-14		5-1/2	JD-RE14102		79.82
RE17344			P-V-1	2-1/2		JD-RE17345		30.04	
TILT (Insider Dozer)	RE17350		P-V-1	2-1/2		JD-RE17345	6520	30.04	
	RE17350		N-N14		5-1/2	JD-RE17351	6520	79.82	
TILT (Insider Dozer)	RE17341	-743282	N-N-14		6-1/4	JD-RE14022		86.50	
	RE17341	-743282	P-V-1	2-3/4		JD-RE17342		40.90	
MODEL 850									
Bulldozer Arrangement			6540, 6545						
DOZER LIFT	AR105285	All	P-U-10	2-1/2	4-1/4	JD-RE18731	6540	53.58	
	AT52374	-307525	P-U-10	2-1/2	4-1/4	JD-RE18731	6545	53.58	
DOZER LIFT (LGP)	RE17462	All	N-N-14		4-1/4	JD-RE17458		54.06	
	RE17462	All	P-V-1	2-1/2		JD-AH142440	6540, 6545	28.55	
DOZER TILT	AR105289	All	P-U-10	2-1/2	5-1/2	JD-AR105275	6540	30.81	
	RE17350	All	P-V-1	2-1/2		JD-RE17345	6540	30.04	
	RE17350	All	N-N14		5-1/2	JD-RE17351	6540	79.82	
DOZER TILT (LGP) (LT)	AR89587	-705569	P-V-8	2-3/4	6-1/4	JD-RE18744	6545	91.30	
	AT52367	-318357	P-V-8	2-3/4	6-1/4	JD-RE18744	6545	91.30	
	RE16538	All	P-V-8	2-3/4	6-1/4	JD-RE18744	6545	91.30	
	RE17349	All	N-N-14		6-1/4	JD-RE14104	6545	82.17	
	RE17349	All	P-V-1	2-3/4		JD-RE17342	6545	40.90	
MODEL 850B									
Bulldozer Arrangement			6540, 6545						
DOZER LIFT	RE17459	All	P-V-1	2-1/2		JD-AH142440	6540, 6545	28.55	
	RE17459	All	N-N-14		4-1/4	JD-RE17458	6540, 6545	54.06	
DOZER LIFT (LGP) (LT)	RE17462	-747861	N-N-14		4-1/4	JD-RE17458		54.06	
	RE17462	All	P-V-1	2-1/2		JD-AH142440		28.55	
	RE35226	747862-	P-V-1	2-1/2		JD-AH142440		28.55	
DOZER LIFT (LT)	RE35226	747862-	N-N-14		4-1/4	JD-RE17458		54.06	
	AH136158	779602-	N-N-14		100 mm	JD-AH137687		45.59	
	AH136158	779602-	P-UB-1	56 mm		JD-RE31716		45.04	
DOZER TILT	AH145297	All	N-N-14		180 mm	JD-AH137211		82.83	
	AH145297	All	P-UB-1	80 mm		JD-RE25152		91.43	
	RE17350	All	P-V-1	2-1/2		JD-RE17345	6540	30.04	
	RE17350	All	N-N14		5-1/2	JD-RE17351	6540	79.82	
DOZER TILT (STD) (LGP) (LT)	RE17349	All	N-N-14		6-1/4	JD-RE14104	6545	82.17	
	RE17349	All	P-V-1	2-3/4		JD-RE17342	6545	40.90	

LGP - Low Ground Pressure LT - Long Track SLF - Super Long Front STD - Straight Dozer WT - Wide Track

Replacement Kits For

JOHN DEERE

JOHN DEERE

Compactors								
APPLICATION	CYL #	SERIAL #	CODE	ROD	BORE	KIT #	Arrangements	List \$
MODEL 646, 646B								
BOOM LIFT		All	P-V-8	2-3/4	6-1/4	JD-RE18744		91.30
BUCKET TILT		-223644	P-V-8	2-1/4	4-1/2	JD-AR105355		46.17
		223645-	P-V-8	2-3/4	6-1/4	JD-RE18744		91.30
MULTI-PURPOSE CLAM		-223644	P-U-9	2	4	JD-JIC-G3229		29.21
		223645-	P-V-8	2	4	JD-AR105387		29.08
STEERING		247907-	P-UB-10	3-3/4	4	JD-AT34932		25.57
STEERING LH		-247906	P-UB-10	3-3/4	4	JD-AT34933		23.53
STEERING RH		-247906	P-UB-10	3-3/4	4	JD-AT34932		25.57
MODEL 646C								
BOOM LIFT		505144-	N-N-14		6-1/4	JD-RE14022		86.50
		505144-	P-V-1	2-3/4		JD-RE16991		54.06
BUCKET TILT		505144-	N-N-14		6-1/4	JD-RE14022		86.50
		505144-	P-V-1	3		JD-RE16992		41.09
MULTI-PURPOSE CLAM		All	P-V-8	2	4	JD-AR105387		29.08
STEERING		-505143	P-UB-10	1-3/4	3-3/4	JD-AR105320		25.95
		505144-	P-V-1	1-3/4		JD-RE16209		20.07
		505144-	N-N-10		3-3/4	JD-RE17099		10.21
Crawler Excavators								
APPLICATION	CYL #	SERIAL #	CODE	ROD	BORE	KIT #	Arrangements	List \$
MODEL 70								
ARM	TH105922		P-UB-10	60 mm	100 mm	JD-TH106099		115.74
ARM/OFFSET BOOM	TH105901		P-UB-10	60 mm	100 mm	JD-TH106099		115.74
	TH106735		P-UB-10	60 mm	100 mm	JD-TH106099		115.74
BLADE	TH105913		P-UB-10	55 mm	90 mm	JD-TH110663		67.64
BOOM	TH105921		P-UB-10	65 mm	115 mm	JD-TH111701		111.90
BUCKET	TH105901		P-UB-10	55 mm	90 mm	JD-TH106853		153.83
OFFSET BOOM	TH106736		P-UB-10	60 mm	110 mm	JD-TH106874		77.54
MODEL 70D								
ARM	TH110528	All	P-UB-10	60 mm	100 mm	JD-TH110662		60.73
	TH110645	All	P-UB-10	60 mm	100 mm	JD-TH110662		60.73
ARM OFFSET	TH110645	All	P-UB-10	60 mm	100 mm	JD-TH110662		60.73
BLADE	TH110626	All	P-UB-10	55 mm	90 mm	JD-TH110663		67.64
BOOM	TH110527	All	P-UB-10	65 mm	115 mm	JD-TH110661		97.12
BUCKET	TH110529	All	P-UB-10	55 mm	90 mm	JD-TH110663		67.64
OFFSET CYL	TH110644	All	P-UB-10	60 mm	110 mm	JD-TH106874		77.54
MODEL 80								
ARM	AP36041	All	P-UB-10	60 mm	95 mm	JD-AT200549		97.08
BOOM	AP36040	All	P-UB-10	65 mm	115 mm	JD-AT200548		128.72
BUCKET	AT250786	All	P-UB-10	55 mm	85 mm	JD-AT200550		102.37
MODEL 110								
BUCKET	AH148041	All	P-UB-10	65 mm	95 mm	JD-AH150595		135.21
MODEL 120								
ARM	AH149792	All	P-UB-10	80 mm	110 mm	JD-AH149796		241.44
BOOM LH	AH153169	All	P-UB-10	70 mm	105 mm	JD-AH151107		401.05
BOOM RH	AH153168	All	P-UB-10	70 mm	105 mm	JD-AH151107		401.05
BUCKET	AH148041	All	P-UB-10	65 mm	95 mm	JD-AH150595		135.21

LGP - Low Ground Pressure LT - Long Track SLF - Super Long Front STD - Straight Dozer WT - Wide Track

JOHN DEERE

Replacement Kits For

JOHN DEERE

Crawler Excavators								
APPLICATION	CYL #	SERIAL #	CODE	ROD	BORE	KIT #	Arrangements	List \$
MODEL 160 LC								
ARM	AH155022	All	P-UB-10	85 mm	115 mm	JD-AH155025		203.81
BOOM LH	AH155042	All	P-UB-10	80 mm	110 mm	JD-AH155045		221.77
BOOM RH	AH155051	All	P-UB-10	80 mm	110 mm	JD-AH155045		221.77
BUCKET	AH155037	All	P-UB-10	75 mm	105 mm	JD-AH155040		298.48
MODEL 190E								
ARM	AT200453		P-UB-10	60 mm	95 mm	JD-AT200549		97.08
BLADE	AT200491		P-UB-10	50 mm	80 mm	JD-AT200574		91.88
BOOM	AT200452		P-UB-10	65 mm	115 mm	JD-AT200548		128.72
BUCKET	AT182460		P-UB-10	55 mm	85 mm	JD-AT200550		102.37
OFFSET BOOM ARM	AT200518		P-UB-10	60 mm	95 mm	JD-AT200549		97.08
OFFSET BOOM CYL	AT200507		P-UB-10	60 mm	105 mm	JD-AT200573		97.65
MODEL 200 LC								
ARM	AH148451	All	P-UB-10	95 mm	130 mm	JD-AH148453		226.10
BOOM LH	AH148792	All	P-UB-10	85 mm	120 mm	JD-AH148785		188.07
BOOM RH	AH148782	All	P-UB-10	85 mm	120 mm	JD-AH148785		188.07
BUCKET	AH148761	All	P-UB-10	75 mm	110 mm	JD-AH148776		203.19
MODEL 230 LC								
ARM	AT154865	All	P-UB-14	100 mm	135 mm	JD-AT183658		117.85
	AT154865	All		100 mm		JD-AT131414	Bushing	32.44
	AT154865	All			135 mm	JD-AT154718	Wear Ring	11.89
	AT154865	All			135 mm	JD-TH110033	Wear Ring	24.80
BOOM LH	AT154864	All	P-UB-14	90 mm	125 mm	JD-AT154867		153.88
	AT154864	All		90 mm		JD-AT154779	Bushing	20.85
	AT154864	All			125 mm	JD-AT154700	Wear Ring	41.21
BOOM RH	AT154864	All			125 mm	JD-AT154735	Wear Ring	8.65
	AT154864	All	P-UB-14	90 mm	125 mm	JD-AT154867		153.88
	AT154864	All		90 mm		JD-AT154779	Bushing	20.85
	AT154864	All			125 mm	JD-AT154700	Wear Ring	41.21
BUCKET	AT154864	All			125 mm	JD-AT154735	Wear Ring	8.65
	AT182459	All	P-UB-14	85 mm	125 mm	JD-AT181250		90.35
	AT182459	All		85 mm		JD-AT154778	Bushing	21.62
	AT182459	All			125 mm	JD-AT154700	Wear Ring	41.21
	AT182459	All			125 mm	JD-AT154735	Wear Ring	8.65
MODEL 270 LC								
ARM	AT218037	All		100 mm		JD-AT131414	Bushing	32.44
	AT218037	All			145 mm	JD-TH110062	Wear Ring	25.18
BOOM LH	AT218036	All			135 mm	JD-AT154718	Wear Ring	11.89
	AT218036	All			135 mm	JD-TH110033	Wear Ring	24.80
BOOM RH	AT218036	All			135 mm	JD-AT154718	Wear Ring	11.89
	AT218036	All			135 mm	JD-TH110033	Wear Ring	24.80
BUCKET	AT218038	All		90 mm		JD-AT154779	Bushing	20.85
	AT218038	All			135 mm	JD-AT154718	Wear Ring	11.89
	AT218038	All			135 mm	JD-TH110033	Wear Ring	24.80
MODEL 290D								
ARM	AT130515	All	P-UB-10	70 mm	105 mm	JD-AT130601		102.95
BOOM	AT130512	All	P-UB-10	65 mm	95 mm	JD-AT130600		89.32
	AT130513	All	P-UB-10	65 mm	95 mm	JD-AT130600		89.32

LGP - Low Ground Pressure LT - Long Track SLF - Super Long Front STD - Straight Dozer WT - Wide Track

Replacement Kits For

JOHN DEERE

JOHN DEERE

Crawler Excavators								
APPLICATION	CYL #	SERIAL #	CODE	ROD	BORE	KIT #	Arrangements	List \$
MODEL 290D								
BUCKET	AT182454	All	P-UB-10	60 mm	95 mm	JD-AT130602		76.29
MODEL 330 LC								
BUCKET	AT250263	All	P-UB-14	95 mm	145 mm	JD-AT181792		102.04
	AT250263	All		95 mm		JD-AT131420	Bushing	27.64
	AT250263	All			145 mm	JD-TH110062	Wear Ring	25.18
	AT250263	All			145 mm	JD-TH110063	Wear Ring	13.79
MODEL 370								
BUCKET	AT250263	All	P-UB-14	95 mm	145 mm	JD-AT181792		102.04
	AT250263	All		95 mm		JD-AT131420	Bushing	27.64
	AT250263	All			145 mm	JD-TH110062	Wear Ring	25.18
	AT250263	All			145 mm	JD-TH110063	Wear Ring	13.79
MODEL 450 LC								
BUCKET LONG ARM	AT182461	-803512	P-UB-14	95 mm	145 mm	JD-AT201185		177.79
	AT182461	803513-	P-UB-14	95 mm	145 mm	JD-AT181792		102.04
	AT182461	All		95 mm		JD-AT131420	Bushing	27.64
	AT182461	All			145 mm	JD-TH110062	Wear Ring	25.18
	AT182461	All			145 mm	JD-TH110063	Wear Ring	13.79
MODEL 490D								
ARM	TH109346	All	P-UB-10	80 mm	115 mm	JD-TH109366		90.40
	TH109346	All		80 mm		JD-T108041	Bushing	19.46
	TH109346	All			115 mm	JD-TH109356	Wear Ring	7.48
	TH109346	All			115 mm	JD-TH109357	Wear Ring	15.66
BOOM	TH109307	All	P-UB-10	75 mm	105 mm	JD-TH109339		78.99
	TH109307	All		75 mm		JD-TH109311	Bushing	16.89
	TH109307	All			105 mm	JD-TH109323	Wear Ring	23.84
	TH109307	All			105 mm	JD-TH109324	Wear Ring	65.29
BUCKET	TH109368	All	P-UB-10	65 mm	95 mm	JD-TH109390		81.99
	TH109368	All		65 mm		JD-TH109372	Bushing	13.52
	TH109368	All			95 mm	JD-TH109377	Wear Ring	6.22
	TH109368	All			95 mm	JD-TH109378	Wear Ring	14.60
MODEL 490E								
ARM	AT154402	All	P-UB-10	80 mm	110 mm	JD-AT177556		152.48
	AT154402	All		80 mm		JD-T108041	Bushing	19.46
	AT154402	All			110 mm	JD-AT153830	Wear Ring	30.61
	AT154402	All			110 mm	JD-AT153936	Wear Ring	7.38
BOOM LH	AT154399	All	P-UB-10	70 mm	105 mm	JD-AT176822		109.73
	AT154399	All		70 mm		JD-AT133645	Bushing	15.27
	AT154399	All			105 mm	JD-TH109323	Wear Ring	23.84
	AT154399	All			105 mm	JD-TH109324	Wear Ring	65.29
BOOM RH	AT154396	All	P-UB-10	70 mm	105 mm	JD-AT176822		109.73
	AT154396	All		70 mm		JD-AT133645	Bushing	15.27
	AT154396	All			105 mm	JD-TH109323	Wear Ring	23.84
	AT154396	All			105 mm	JD-TH109324	Wear Ring	65.29
BUCKET	AT154407	All	P-UB-10	65 mm	95 mm	JD-AT176737		117.85
	AT154407	All		65 mm		JD-TH109372	Bushing	13.52
	AT154407	All			95 mm	JD-TH109377	Wear Ring	6.22
	AT154407	All			95 mm	JD-TH109378	Wear Ring	14.60

LGP - Low Ground Pressure LT - Long Track SLF - Super Long Front STD - Straight Dozer WT - Wide Track

Replacement Kits For

JOHN DEERE

JOHN DEERE

Crawler Excavators								
APPLICATION	CYL #	SERIAL #	CODE	ROD	BORE	KIT #	Arrangements	List \$
MODEL 495D								
ARM	AT127253	All	P-UB-10	75 mm	105 mm	JD-TH109339		78.99
	AT127253	All		75 mm		JD-TH109311	Bushing	16.89
	AT127253	All			105 mm	JD-TH109323	Wear Ring	23.84
	AT127253	All			105 mm	JD-TH109324	Wear Ring	65.29
BOOM LH	AT127252	All		70 mm		JD-AT133645	Bushing	15.27
	AT127252	All			95 mm	JD-TH109377	Wear Ring	6.22
BOOM RH	AT127252	All			95 mm	JD-TH109378	Wear Ring	14.60
	AT127254	All		70 mm		JD-AT133645	Bushing	15.27
BUCKET	AT127254	All			95 mm	JD-TH109377	Wear Ring	6.22
	AT127254	All			95 mm	JD-TH109378	Wear Ring	14.60
	AT182453	All	P-UB-10	65 mm	95 mm	JD-TH109390		81.99
BUCKET	AT182453	All		65 mm		JD-TH109372	Bushing	13.52
	AT182453	All			95 mm	JD-TH109377	Wear Ring	6.22
	AT182453	All			95 mm	JD-TH109378	Wear Ring	14.60
	AT182453	All			95 mm	JD-TH109378	Wear Ring	14.60
MODEL 590D								
ARM	AT127249	All	P-UB-10	85 mm	120 mm	JD-AT192075		78.53
	AT127249	All		85 mm		JD-T108019	Bushing	21.62
	AT127249	All			120 mm	JD-T108046	Wear Ring	8.10
	AT127249	All			120 mm	JD-TH104923	Wear Ring	23.82
BOOM LH	AT127250	All	P-UB-10	80 mm	115 mm	JD-AT194335		164.35
	AT127250	All		80 mm		JD-T108041	Bushing	19.46
	AT127250	All			115 mm	JD-TH109356	Wear Ring	7.48
BOOM RH	AT127250	All			115 mm	JD-TH109357	Wear Ring	15.66
	AT127251	All	P-UB-10	80 mm	115 mm	JD-AT194335		164.35
	AT127251	All		80 mm		JD-T108041	Bushing	19.46
BUCKET	AT127251	All			115 mm	JD-TH109356	Wear Ring	7.48
	AT127251	All			115 mm	JD-TH109357	Wear Ring	15.66
	AT127248	All	P-UB-10	80 mm	115 mm	JD-AT194335		164.35
	AT127248	All		80 mm		JD-T108041	Bushing	19.46
	AT127248	All			115 mm	JD-TH109356	Wear Ring	7.48
	AT127248	All			115 mm	JD-TH109357	Wear Ring	15.66
	AT182452	All	P-UB-10	80 mm	115 mm	JD-AT194335		164.35
	AT182452	All		80 mm		JD-T108041	Bushing	19.46
BUCKET	AT182452	All			115 mm	JD-TH109356	Wear Ring	7.48
	AT182452	All			115 mm	JD-TH109357	Wear Ring	15.66
MODEL 595								
BOOM LH	TH105582	All			120 mm	JD-TH104923	Wear Ring	23.82
BOOM RH	TH105582	All			120 mm	JD-TH104923	Wear Ring	23.82
BUCKET	AT182464	All			120 mm	JD-TH104923	Wear Ring	23.82
	TH105584	All			120 mm	JD-TH104923	Wear Ring	23.82
MODEL 595D								
ARM	AT127249	All		85 mm		JD-T108019	Bushing	21.62
	AT127249	All			120 mm	JD-T108046	Wear Ring	8.10
	AT127249	All			120 mm	JD-TH104923	Wear Ring	23.82
BOOM LH	AT127250	All		80 mm		JD-T108041	Bushing	19.46
	AT127250	All			115 mm	JD-TH109356	Wear Ring	7.48
	AT127250	All			115 mm	JD-TH109357	Wear Ring	15.66

LGP - Low Ground Pressure LT - Long Track SLF - Super Long Front STD - Straight Dozer WT - Wide Track

Replacement Kits For

JOHN DEERE

JOHN DEERE

Crawler Excavators								
APPLICATION	CYL #	SERIAL #	CODE	ROD	BORE	KIT #	Arrangements	List \$
MODEL 595D								
BOOM RH	AT127251	All		80 mm		JD-T108041	Bushing	19.46
	AT127251	All			115 mm	JD-TH109356	Wear Ring	7.48
BUCKET	AT127251	All			115 mm	JD-TH109357	Wear Ring	15.66
	AT127248	All		80 mm		JD-T108041	Bushing	19.46
	AT127248	All			115 mm	JD-TH109356	Wear Ring	7.48
	AT127248	All			115 mm	JD-TH109357	Wear Ring	15.66
	AT182452	All		80 mm		JD-T108041	Bushing	19.46
	AT182452	All			115 mm	JD-TH109356	Wear Ring	7.48
	AT182452	All			115 mm	JD-TH109357	Wear Ring	15.66
MODEL 690, 690A								
BOOM		-749	P-V-8	2-3/4	4-1/2	JD-RE18760		42.34
		750-	P-V-8	2-3/4	5	JD-AR105309		47.11
	AR89435	001663-	P-V-8	2-3/4	5	JD-AR105309		47.11
BUCKET CROWD (ARM)	RE21394	All	P-U-1	2-3/4		JD-RE21395		82.17
		All	P-V-8	3-1/4	5-1/2	JD-AR105312		51.90
		Field Replacement Check Piston	P-V-1	3-1/4		JD-RE15906		29.13
		Field Replacement Check Piston	N-N-14		5-1/2	JD-RE15907		79.82
	AT32257	All	P-V-8	3-1/4	5-1/2	JD-AR105312		51.90
	AT41907	All	P-V-8	3-1/4	5-1/2	JD-AR105313		50.49
	AU43243	All	P-V-8	3-1/4	5-1/2	JD-AR105312		51.90
MODEL 690B								
BOOM	AR89435	-501306	P-V-8	2-3/4	5	JD-AR105309		47.11
	RE12257	501307-	N-N-14		5	JD-RE15905		65.47
	RE12257	501307-	P-V-1	2-3/4		JD-RE17342		40.90
BUCKET	RE21394	All	N-N-14		5	JD-RE15905		65.47
	RE21394	All	P-U-1	2-3/4		JD-RE21395		82.17
	RE11341	-501306	P-V-8	3-1/4	5-1/2	JD-AR105312		51.90
	RE21400	501307-	N-N-14		5-1/2	JD-RE14102		79.82
	RE21400	501307-	P-V-1	3-1/4		JD-RE15906		29.13
	RE21400	All	N-N-14		5-1/2	JD-RE14102		79.82
	RE21400	All	P-U-1	3-1/4		JD-RE21401		56.34
CROWD (ARM)		501307-	P-V-1	3-1/4		JD-RE15906		29.13
	AT41907	-501306	P-V-8	3-1/4	5-1/2	JD-AR105313		50.49
	RE21406	501307-	N-N-14		5-1/2	JD-RE15907		79.82
RE21406	501307-	P-U-1	3-1/4		JD-RE21401		56.34	
MODEL 690C								
BOOM	RE18949	-509184	N-N-14		5	JD-RE15905		65.47
	RE18949	-509184	P-V-1	2-3/4		JD-RE17342		40.90
	RE21394	509185-	N-N-14		5	JD-RE15905		65.47
BUCKET	RE21394	509185-	P-U-1	2-3/4		JD-RE21395		82.17
	RE18950	-509184	N-N-14		5-1/2	JD-RE14102		79.82
	RE18950	-509184	P-V-1	3-1/4		JD-RE15906		29.13
	RE21400	509185-	N-N-14		5-1/2	JD-RE14102		79.82
	RE21400	509185-	P-U-1	3-1/4		JD-RE21401		56.34

LGP - Low Ground Pressure LT - Long Track SLF - Super Long Front STD - Straight Dozer WT - Wide Track

Replacement Kits For

JOHN DEERE

JOHN DEERE

Crawler Excavators								
APPLICATION	CYL #	SERIAL #	CODE	ROD	BORE	KIT #	Arrangements	List \$
MODEL 690C								
CROWD (ARM)	RE18951	-509184	P-V-1	3-1/4		JD-RE15906		29.13
	RE18951	-509184	N-N-14		5-1/2	JD-RE15907		79.82
	RE21406	509185-	N-N-14		5-1/2	JD-RE15907		79.82
	RE21406	509185-	P-U-1	3-1/4		JD-RE21401		56.34
MODEL 690CR								
ANGLING ARM	AU13861	All	P-V-8	1-1/2	3-1/2	JD-AR105432		24.64
	RE21406	All	N-N-14		5-1/2	JD-RE15907		79.82
	RE21406	All	P-U-1	3-1/4		JD-RE21401		56.34
BOOM	RE18949	-509184	N-N-14		5	JD-RE15905		65.47
	RE18949	-509184	P-V-1	2-3/4		JD-RE17342		40.90
	RE21394	509185-	N-N-14		5	JD-RE15905		65.47
BUCKET	RE21394	509185-	P-U-1	2-3/4		JD-RE21395		82.17
	RE21400	All	N-N-14		5-1/2	JD-RE14102		79.82
	RE21400	All	P-U-1	3-1/4		JD-RE21401		56.34
LIFT	AU13861	All	P-V-8	1-1/2	3-1/2	JD-AR105432		24.64
TILT	AU13847	All	P-V-8	1-1/2	3-1/2	JD-AR105432		24.64
MODEL 690D								
ARM	AT114837	All	P-UB-10	95 mm	135 mm	JD-AT114831		120.28
BOOM	AT112705	All	P-UB-10	85 mm	125 mm	JD-AT114822		100.25
	AT112705	All		85 mm		JD-T108019	Bushing	21.62
BUCKET	AT114838	All	P-UB-10	80 mm	120 mm	JD-AT114836		92.26
	AT182451	All	P-UB-10	80 mm	120 mm	JD-AT114836		92.26
	AT182451	All		80 mm		JD-T108041	Bushing	19.46
	AT182451	All			120 mm	JD-T108046	Wear Ring	8.10
BUCKET (SFL)	AT182451	All			120 mm	JD-TH104923	Wear Ring	23.82
	AT86766	All			100 mm	JD-TH111727	Wear Ring	6.92
	AT86766	All			100 mm	JD-TH111728	Wear Ring	28.05
MODEL 690E								
ARM	AH144677		P-UB-14	95 mm	130 mm	JD-AH144595		187.92
BOOM	AH140588		P-UB-14	85 mm	120 mm	JD-AH144594		225.13
	AH144671		P-UB-14	85 mm	120 mm	JD-AH144594		225.13
	AH144674		P-UB-14	85 mm	120 mm	JD-AH144594		225.13
BUCKET	AH140587		P-UB-14	75 mm	110 mm	JD-AH144593		210.16
	AH142409		P-UB-14	75 mm	110 mm	JD-AH144593		210.16
MODEL 690E LC								
ARM	AH140590	-544625	P-UB-14	95 mm	130 mm	JD-AH144595		187.92
	AH140590	-544625		95 mm		JD-H146481	Bushing	23.48
	AH144677	544626-	P-UB-14	95 mm	130 mm	JD-AH144595		187.92
	AH144677	544626-		95 mm		JD-H146481	Bushing	23.48
BOOM LH	AH140588	-544743	P-UB-14	85 mm	120 mm	JD-AH144594		225.13
	AH140588	-544743		85 mm		JD-H146480	Bushing	21.62
	AH144671	544744-	P-UB-14	85 mm	120 mm	JD-AH144594		225.13
	AH144671	544744-		85 mm		JD-H146480	Bushing	21.62
BOOM RH	AH140589	-544743	P-UB-14	85 mm	120 mm	JD-AH144594		225.13
	AH140589	-544743		85 mm		JD-H146480	Bushing	21.62
	AH144674	544744-	P-UB-14	85 mm	120 mm	JD-AH144594		225.13
	AH144674	544744-		85 mm		JD-H146480	Bushing	21.62

LGP - Low Ground Pressure LT - Long Track SLF - Super Long Front STD - Straight Dozer WT - Wide Track

Replacement Kits For

JOHN DEERE

JOHN DEERE

Crawler Excavators									
APPLICATION	CYL #	SERIAL #	CODE	ROD	BORE	KIT #	Arrangements	List \$	
MODEL 690E LC									
BUCKET	AH142409	-538666	P-UB-14	75 mm	110 mm	JD-AH144593		210.16	
	AH142409	-538666		75 mm		JD-H146479	Bushing	16.89	
	AH142409	538667-544273	P-UB-14	75 mm	110 mm	JD-AH144593		210.16	
	AH142409	538667-544273		75 mm		JD-H146479	Bushing	16.89	
	AH144595	544274-544696		75 mm		JD-H146479	Bushing	16.89	
	AH162295	544274-544696	P-UB-14	75 mm	110 mm	JD-AH144593		210.16	
	AH162295	544697-	P-UB-14	75 mm	110 mm	JD-AH144593		210.16	
	AH162295	544697-		75 mm		JD-H146479	Bushing	16.89	
	BUCKET (SLF)	AT159611	All	P-UB-10	65 mm	95 mm	JD-AT176737		117.85
		AT159611	All		65 mm		JD-TH109372	Bushing	13.52
		AT159611	All			95 mm	JD-TH109377	Wear Ring	6.22
		AT159611	All			95 mm	JD-TH109378	Wear Ring	14.60
MODEL 790									
ARM	TH106316	All	P-UB-14	105 mm	150 mm	JD-TH102827		131.78	
BOOM	TH102467	All	P-UB-14	95 mm	140 mm	JD-TH102798		136.36	
	TH106315	All	P-UB-14	95 mm	140 mm	JD-TH102798		136.36	
BUCKET	AT182467	All	P-UB-10	90 mm	140 mm	JD-TH102845		120.01	
	TH106317	All	P-UB-10	90 mm	140 mm	JD-TH102845		120.01	
MODEL 790D									
ARM	AT131428	007004-	P-UB-14	100 mm	145 mm	JD-TH110064		132.87	
	AT131428	007004-			145 mm	JD-TH110062	Wear Ring	25.18	
	AT131428	007004-			145 mm	JD-TH110063	Wear Ring	13.79	
	TH110043	-007003	P-UB-14	100 mm	145 mm	JD-TH110064		132.87	
	TH110043	-007003			145 mm	JD-TH110062	Wear Ring	25.18	
	TH110043	-007003			145 mm	JD-TH110063	Wear Ring	13.79	
ARM (SLF)	AT114837	All	P-UB-10	95 mm	135 mm	JD-AT114831		120.28	
	AT114837	All		95 mm		JD-T108050	Bushing	23.48	
BOOM	AT131425	All	P-UB-14	90 mm	135 mm	JD-TH110035		123.98	
	AT131425	All			135 mm	JD-TH110033	Wear Ring	24.80	
BUCKET	AT131430	All	P-UB-14	90 mm	135 mm	JD-TH110035		123.98	
	AT131430	All			135 mm	JD-TH110033	Wear Ring	24.80	
BUCKET (SLF)	AT86766	All		65 mm		JD-TH109372	Bushing	13.52	
	AT86766	All			100 mm	JD-TH111727	Wear Ring	6.92	
	AT86766	All			100 mm	JD-TH111728	Wear Ring	28.05	
MODEL 790E LC									
ARM	AT154865	-HJ900100	P-UB-14	100 mm	135 mm	JD-AT154868		112.17	
	AT154865	-HJ900100		100 mm		JD-AT131414	Bushing	32.44	
	AT154865	-HJ900100			135 mm	JD-AT154718	Wear Ring	11.89	
	AT154865	-HJ900100			135 mm	JD-TH110033	Wear Ring	24.80	
	AT154865	HJ900101-	P-UB-14	100 mm	135 mm	JD-AT183658		117.85	
	AT154865	HJ900101-		100 mm		JD-AT131414	Bushing	32.44	
	AT154865	HJ900101-			135 mm	JD-AT154718	Wear Ring	11.89	
	AT154865	HJ900101-			135 mm	JD-TH110033	Wear Ring	24.80	
ARM (SLF)	AT161589	All	P-UB-14	105 mm	145 mm	JD-AT176734		173.96	
	AT161589	All	P-UB-14	105 mm	145 mm	JD-AT176734		173.96	
	AT161589	All		105 mm		JD-AT161596	Bushing	27.68	
	AT161589	All			145 mm	JD-AT161607	Wear Ring	10.46	

LGP - Low Ground Pressure LT - Long Track SLF - Super Long Front STD - Straight Dozer WT - Wide Track

Replacement Kits For

JOHN DEERE

JOHN DEERE

Crawler Excavators								
APPLICATION	CYL #	SERIAL #	CODE	ROD	BORE	KIT #	Arrangements	List \$
MODEL 790E LC								
ARM (SLF)	AT161589	All			145 mm	JD-AT161608	Wear Ring	31.30
BOOM LH	AT154864	All	P-UB-14	90 mm	125 mm	JD-AT154867		153.88
	AT154864	All		90 mm		JD-AT154779	Bushing	20.85
	AT154864	All			125 mm	JD-AT154700	Wear Ring	41.21
BOOM RH	AT154864	All			125 mm	JD-AT154735	Wear Ring	8.65
	AT154864	All	P-UB-14	90 mm	125 mm	JD-AT154867		153.88
	AT154864	All		90 mm		JD-AT154779	Bushing	20.85
	AT154864	All			125 mm	JD-AT154700	Wear Ring	41.21
BUCKET	AT154864	All			125 mm	JD-AT154735	Wear Ring	8.65
	AT182459	All	P-UB-14	85 mm	125 mm	JD-AT181250		90.35
	AT182459	All		85 mm		JD-AT154778	Bushing	21.62
	AT182459	All			125 mm	JD-AT154700	Wear Ring	41.21
	AT182459	All			125 mm	JD-AT154735	Wear Ring	8.65
BUCKET (SLF)	AT159611	All	P-UB-10	65 mm	95 mm	JD-AT176737		117.85
	AT159611	All		65 mm		JD-TH109372	Bushing	13.52
	AT159611	All			95 mm	JD-TH109377	Wear Ring	6.22
	AT159611	All			95 mm	JD-TH109378	Wear Ring	14.60
MODEL 792								
ARM	TH106313	All	P-UB-10	110 mm	160 mm	JD-TH103347		150.70
BOOM	TH102340	All	P-UB-10	100 mm	150 mm	JD-AT194457		132.04
	TH106312	All	P-UB-10	100 mm	150 mm	JD-AT194457		132.04
	TH106312	All	P-UB-10	110 mm	160 mm	JD-TH103324		118.26
BUCKET	AT182466	All	P-UB-10	95 mm	150 mm	JD-TH103357		132.32
	TH106314	All	P-UB-10	95 mm	150 mm	JD-TH103357		132.32
MODEL 792D, 792D LC								
ARM	AT205924	All	P-UB-14	105 mm	150 mm	JD-TH111854		175.70
BOOM	AT205923	All	P-UB-14	95 mm	145 mm	JD-TH111625		165.42
	AT205923	All		95 mm		JD-AT131420	Bushing	27.64
	AT205923	All			145 mm	JD-TH110062	Wear Ring	25.18
BUCKET	AT205925	-803512	P-UB-14	95 mm	145 mm	JD-TH111625		165.42
	AT205925	803513-	P-UB-14	95 mm	145 mm	JD-AT181792		102.04
	AT205925	All		95 mm		JD-AT131420	Bushing	27.64
	AT205925	All			145 mm	JD-TH110062	Wear Ring	25.18
MODEL 890								
BOOM	RE11569	All	N-N-14		7-1/2	JD-RE14033	Capseal Style	105.84
	RE21201	All	N-N-14		7-1/2	JD-RE14033	Re-Capseal Style	105.84
	RE21201	All	P-U-1	3-3/4		JD-RE21202	Re-Capseal Style	116.70
BUCKET	RE11571	All	N-N-14		7-1/2	JD-RE14033	Capseal Style	105.84
CROWD	RE11568	All	N-N-14		7-1/2	JD-RE14033	Capseal Style	105.84
	RE21195	All	N-N-14		7-1/2	JD-RE14033	Replacement	105.84
MODEL 890A								
BOOM	RE21210	All	P-U-1	3-3/4		JD-RE21202	Replacement	116.70
MODEL 892D, 892D LC								
ARM	AT131416	-703549	P-UB-14	110 mm	165 mm	JD-TH111627		195.70
	AT131416	703550-	P-UB-14	110 mm	165 mm	JD-AT181799		146.84
	AT131416	All		110 mm		JD-AT131417	Bushing	52.61

LGP - Low Ground Pressure LT - Long Track SLF - Super Long Front STD - Straight Dozer WT - Wide Track

Replacement Kits For

JOHN DEERE

JOHN DEERE

Crawler Excavators								
APPLICATION	CYL #	SERIAL #	CODE	ROD	BORE	KIT #	Arrangements	List \$
MODEL 892D, 892D LC								
ARM	AT131416	All			165 mm	JD-TH111273	Wear Ring	16.22
	AT131416	All			165 mm	JD-TH111274	Wear Ring	53.33
	TH111616	-703549	P-UB-14	110 mm	165 mm	JD-TH111627		195.70
	TH111616	703550-	P-UB-14	110 mm	165 mm	JD-AT181799		146.84
	TH111616	All		110 mm		JD-AT131417	Bushing	52.61
	TH111616	All			165 mm	JD-TH111273	Wear Ring	16.22
	TH111616	All			165 mm	JD-TH111274	Wear Ring	53.33
ARM (SLF)	AT130835	All	P-UB-14	105 mm	150 mm	JD-TH111854		175.70
BOOM LH	AT131413	-603426	P-UB-14	100 mm	145 mm	JD-TH111626		166.79
	AT131413	603427-	P-UB-14	100 mm	145 mm	JD-AT181794		120.69
	AT131413	All		100 mm		JD-AT131414	Bushing	32.44
	AT131413	All			145 mm	JD-TH110062	Wear Ring	25.18
BOOM RH	AT131413	All			145 mm	JD-TH110063	Wear Ring	13.79
	AT131413	-503424	P-UB-14	100 mm	145 mm	JD-TH111626		166.79
	AT131413	503425-	P-UB-14	100 mm	145 mm	JD-AT181794		120.69
	AT131413	All		100 mm		JD-AT131414	Bushing	32.44
BUCKET	AT131413	All			145 mm	JD-TH110062	Wear Ring	25.18
	AT131413	All			145 mm	JD-TH110063	Wear Ring	13.79
	AT182455	-803512	P-UB-14	95 mm	145 mm	JD-TH111625		165.42
	AT182455	803513-	P-UB-14	95 mm	145 mm	JD-AT181792		102.04
	AT182455	All		95 mm		JD-AT131420	Bushing	27.64
BUCKET (SLF)	AT182455	All			145 mm	JD-TH110062	Wear Ring	25.18
	AT182455	All			145 mm	JD-TH110063	Wear Ring	13.79
	AT86766	All			100 mm	JD-TH111727	Wear Ring	6.92
AT86766	All			100 mm	JD-TH111728	Wear Ring	28.05	
MODEL 892E, 892E LC								
ARM	AT201181	-703549	P-UB-14	110 mm	165 mm	JD-AT201184		220.35
	AT201181	703550-	P-UB-14	110 mm	165 mm	JD-AT181799		146.84
	AT201181	All		110 mm		JD-AT131417	Bushing	52.61
	AT201181	All			165 mm	JD-TH111273	Wear Ring	16.22
	AT201181	All			165 mm	JD-TH111274	Wear Ring	53.33
BOOM LH	AT201180	-603426	P-UB-14	100 mm	145 mm	JD-TH111626		166.79
	AT201180	603427-	P-UB-14	100 mm	145 mm	JD-AT181794		120.69
	AT201180	All		100 mm		JD-AT131414	Bushing	32.44
	AT201180	All			145 mm	JD-TH110062	Wear Ring	25.18
BOOM RH	AT201180	All			145 mm	JD-TH110063	Wear Ring	13.79
	AT201180	-503424	P-UB-14	100 mm	145 mm	JD-TH111626		166.79
	AT201180	503425-	P-UB-14	100 mm	145 mm	JD-AT181794		120.69
	AT201180	All		100 mm		JD-AT131414	Bushing	32.44
BUCKET	AT201180	All			145 mm	JD-TH110062	Wear Ring	25.18
	AT201180	All			145 mm	JD-TH110063	Wear Ring	13.79
	AT182461	-803512	P-UB-14	95 mm	145 mm	JD-AT201185		177.79
	AT182461	803513-	P-UB-14	95 mm	145 mm	JD-AT181792		102.04
	AT182461	All		95 mm		JD-AT131420	Bushing	27.64
	AT182461	All			145 mm	JD-TH110062	Wear Ring	25.18
	AT182461	All			145 mm	JD-TH110063	Wear Ring	13.79
AT201182	-803512	P-UB-14	95 mm	145 mm	JD-AT201185		177.79	

LGP - Low Ground Pressure LT - Long Track SLF - Super Long Front STD - Straight Dozer WT - Wide Track

Replacement Kits For

JOHN DEERE

JOHN DEERE

Crawler Excavators								
APPLICATION	CYL #	SERIAL #	CODE	ROD	BORE	KIT #	Arrangements	List \$
MODEL 892E, 892E LC								
BUCKET BUCKET (SLF)	AT201182	803513-	P-UB-14	95 mm	145 mm	JD-AT181792		102.04
	AT201182	All		95 mm		JD-AT131420	Bushing	27.64
	AT201182	All			145 mm	JD-TH110062	Wear Ring	25.18
	AT201182	All			145 mm	JD-TH110063	Wear Ring	13.79
	AT168750	011000-	P-UB-10	65 mm	100 mm	JD-AT168764		104.13
	AT168750	011000-		65 mm		JD-TH109372	Bushing	13.52
	AT168750	011000-			100 mm	JD-TH111727	Wear Ring	6.92
AT168750	011000-			100 mm	JD-TH111728	Wear Ring	28.05	
MODEL 990								
BOOM			N-N-14		7-1/2	JD-RE14033		105.84
	RE11569	510036-	N-N-14		7-1/2	JD-RE14033		105.84
	RE21201	All	N-N-14		7-1/2	JD-RE14033	Replacement	105.84
	RE21201	All	P-U-1	3-3/4		JD-RE21202	Replacement	116.70
BUCKET	RE11570	-510035	N-N-14		7-1/2	JD-RE14033		105.84
	RE21207	510036-	N-N-14		7-1/2	JD-RE14033		105.84
CROWD	RE11568	-510035	N-N-14		7-1/2	JD-RE14033		105.84
	RE21195	510036-	N-N-14		7-1/2	JD-RE14033		105.84
MODEL 992D, 992D LC								
ARM	AT131955	All	P-UB-10	130 mm	190 mm	JD-AT132412		202.73
	AT132310		P-UB-10	130 mm	190 mm	JD-AT132412		202.73
BOOM	AT131954	All	P-UB-10	115 mm	170 mm	JD-AT132411		189.29
	AT132280	5222	P-UB-10	115 mm	170 mm	JD-AT132411		189.29
BUCKET 2.9M, 3.9M ARM	AT132280	5222	P-UB-10	115 mm	170 mm	JD-AT132411		189.29
	AT182457	All	P-UB-10	115 mm	170 mm	JD-AT132411		189.29
BUCKET 4.9M ARM	AT182455	All	P-UB-14	95 mm	145 mm	JD-AT181792		102.04
	AT182455	All	P-UB-14	95 mm	145 mm	JD-TH111625		165.42
	AT182455	All		95 mm		JD-AT131420	Bushing	27.64
	AT182455	All			145 mm	JD-TH110062	Wear Ring	25.18
	AT182455	All			145 mm	JD-TH110063	Wear Ring	13.79
MODEL 992E, 992E LC								
BUCKET 4.9M ARM	AT182461	-803512	P-UB-14	95 mm	145 mm	JD-AT201185		177.79
	AT182461	803513-	P-UB-14	95 mm	145 mm	JD-AT181792		102.04
	AT182461	All		95 mm		JD-AT131420	Bushing	27.64
	AT182461	All			145 mm	JD-TH110062	Wear Ring	25.18
	AT182461	All			145 mm	JD-TH110063	Wear Ring	13.79
Feller Bunchers								
APPLICATION	CYL #	SERIAL #	CODE	ROD	BORE	KIT #	Arrangements	List \$
MODEL 493D								
ARM	TH109346	All	P-UB-10	80 mm	115 mm	JD-TH109366		90.40
BOOM	TH109307	All	P-UB-10	75 mm	105 mm	JD-TH109339		78.99
BUCKET	TH109368	All	P-UB-10	65 mm	95 mm	JD-TH109390		81.99
MODEL 653E								
ARM	AH142919		P-UB-14	85 mm	120 mm	JD-AH144594		225.13
BOOM	AH142577		P-UB-14	85 mm	120 mm	JD-AH144594		225.13
HEAD TILT	AH144660		P-UB-14	75 mm	110 mm	JD-AH144593		210.16

LGP - Low Ground Pressure LT - Long Track SLF - Super Long Front STD - Straight Dozer WT - Wide Track

Replacement Kits For

JOHN DEERE

JOHN DEERE

Feller Bunchers								
APPLICATION	CYL #	SERIAL #	CODE	ROD	BORE	KIT #	Arrangements	List \$
MODEL 693B								
BOOM		-501444	P-V-8	2-3/4	5	JD-AR105309		47.11
		501445-	N-N-14		5	JD-RE15905		65.47
		501445-	P-V-1	2-3/4		JD-RE17342		40.90
	RE21394	501445-	N-N-14		5	JD-RE15905		65.47
	RE21394	501445-	P-U-1	2-3/4		JD-RE21395		82.17
CROWD		-501444	P-V-8	3-1/4	5-1/2	JD-AR105313		50.49
		501445-	P-V-1	3-1/4		JD-RE15906		29.13
		501445-	N-N-14		5-1/2	JD-RE15907		79.82
MULTI-STEM		All	P-U-10	1-3/4	4	JD-AT55695		17.62
SHEAR		All	P-U-10	2-1/2	6-1/2	JD-AR105280		93.31
SHEAR TILT		All	P-V-8	2-1/4	4-1/2	JD-AR105355		46.17
TILT		-501444	P-V-8	3-1/4	5-1/2	JD-AR105312		51.90
		501445-	N-N-14		5-1/2	JD-RE14102		79.82
		501445-	P-V-1	3-1/4		JD-RE15906		29.13
	RE21400	501307-	N-N-14		5-1/2	JD-RE14102		79.82
	RE21400	501307-	P-U-1	3-1/4		JD-RE21401		56.34
MODEL 693C								
BOOM		-509184	N-N-14		5	JD-RE15905		65.47
		-509184	P-V-1	2-3/4		JD-RE17342		40.90
		509185-	N-N-14		5	JD-RE15905		65.47
		509185-	P-U-1	2-3/4		JD-RE21395		82.17
HEAD TILT		-509184	N-N-14		5-1/2	JD-RE14102		79.82
		-509184	P-V-1	3-1/4		JD-RE15906		29.13
		509185-	N-N-14		5-1/2	JD-RE14102		79.82
		509185-	P-U-1	3-1/4		JD-RE21401		56.34
MODEL 693D								
ARM	AT112705	All	P-UB-10	85 mm	125 mm	JD-AT114822		100.25
	AT112705	All		85 mm		JD-T108019	Bushing	21.62
BOOM	AT112705	All	P-UB-10	85 mm	125 mm	JD-AT114822		100.25
	AT112705	All		85 mm		JD-T108019	Bushing	21.62
BUCKET	AT114838	All	P-UB-10	80 mm	120 mm	JD-AT114836		92.26
	AT182451	All	P-UB-10	80 mm	120 mm	JD-AT114836		92.26
	AT182451	All		80 mm		JD-T108041	Bushing	19.46
	AT182451	All			120 mm	JD-T108046	Wear Ring	8.10
	AT182451	All			120 mm	JD-TH104923	Wear Ring	23.82
MODEL 743,743A Tree Harvesters								
AXLE STABILIZER		All	P-U-5	2	4-1/2	JD-AR105515		60.48
DOZER LIFT		All	P-V-8	2	5	JD-RE18743		35.14
		Field Replacement Check Piston	N-N-14		5	JD-RE15905		65.47
		Field Replacement Check Piston	P-V-1	2		JD-RE30817		20.90
FEED ROLL		All	P-V-8	1-1/4	2-1/2	JD-AR105453		23.06
GRAPPLE		All	P-U-10	1-3/4	4	JD-AT55695		17.62
LOG ACCUMULATOR		All	P-V-8	1-3/4	3	JD-RE18751		23.68
MAIN LIFT		All	P-V-8	3-1/4	6-1/4	JD-RE18762		89.26

LGP - Low Ground Pressure LT - Long Track SLF - Super Long Front STD - Straight Dozer WT - Wide Track

Replacement Kits For

JOHN DEERE

JOHN DEERE

Feller Bunchers								
APPLICATION	CYL #	SERIAL #	CODE	ROD	BORE	KIT #	Arrangements	List \$
MODEL 743,743A Tree Harvesters								
SECONDARY LIFT		All	P-V-8	2-3/4	4-1/2	JD-RE18760		42.34
SHEAR		All	P-U-10	2-1/2	6-1/2	JD-AR105280		93.31
STEERING		All	P-UB-10	4-1/4	4.40	JD-RE19224		31.01
TILT		All	P-V-8	2-1/4	4-1/2	JD-AR105355		46.17
MODEL 793D								
ARM	AT131425	All	P-UB-14	90 mm	135 mm	JD-TH110035		123.98
	AT131425	All			135 mm	JD-TH110033	Wear Ring	24.80
BOOM	AT131425	All	P-UB-14	90 mm	135 mm	JD-TH110035		123.98
	AT131425	All			135 mm	JD-TH110033	Wear Ring	24.80
BUCKET	AT131430	All	P-UB-14	90 mm	135 mm	JD-TH110035		123.98
	AT131430	All			135 mm	JD-TH110033	Wear Ring	24.80
MODEL 853								
			P-UB-14	75 mm	110 mm	JD-AH144593		210.16
			P-UB-14	85 mm	120 mm	JD-AH144594		225.13
Loader Backhoes								
APPLICATION	CYL #	SERIAL #	CODE	ROD	BORE	KIT #	Arrangements	List \$
MODEL 300B								
Backhoe Arrangement			9250, 9250A					
BACKHOE BOOM		All	P-V-8	2	4	JD-RE18732		29.99
BACKHOE BUCKET		All	P-V-8	1-3/4	3	JD-RE18751		23.68
BACKHOE CROWD		All	P-V-8	1-3/4	3-1/2	JD-RE18755		25.40
BACKHOE STABILIZER		All	P-V-8	1-3/4	3-1/2	JD-RE18754		31.52
BACKHOE SWING		39797-	P-U-10	1-3/4	3-1/2	JD-RE18756	9250A	31.35
		All	P-V-8	2	4	JD-RE18732	9250	29.99
LOADER BOOM LIFT		All	P-V-8	1-3/4	2-3/4	JD-RE19220		25.07
		All	P-V-8	1-3/4	2-3/4	JD-RE19220		25.07
LOADER BUCKET TILT		All	P-V-8	1-1/2	2-1/2	JD-RE19217		19.48
		All	P-V-8	1-1/2	2-1/2	JD-RE19217		19.48
MODEL 302A								
Backhoe Arrangement			9250, 9250A					
BACKHOE BOOM		All	P-V-8	2	4	JD-RE18732		29.99
BACKHOE BUCKET		All	P-V-8	1-3/4	3	JD-RE18751		23.68
BACKHOE CROWD		All	P-V-8	1-3/4	3-1/2	JD-RE18755		25.40
BACKHOE STABILIZER		All	P-V-8	1-3/4	3-1/2	JD-RE18754		31.52
BACKHOE SWING		39797-	P-U-10	1-3/4	3-1/2	JD-RE18756	9250A	31.35
		All	P-V-8	2	4	JD-RE18732	9250	29.99
MODEL 310								
Backhoe Arrangement			9450, 9500					
BACKHOE BOOM		All	P-V-8	2-1/4	4-1/2	JD-AR105355		46.17
BACKHOE BUCKET		All	P-V-8	2-1/4	3-1/2	JD-RE18757		33.94
BACKHOE CROWD		All	P-V-8	2	4	JD-AR105387		29.08
BACKHOE STABILIZER		All	P-V-8	1-3/4	3-1/2	JD-RE18754	9405	31.52
		All	P-V-8	1-3/4	3	JD-RE18751	9500	23.68
BACKHOE SWING		All	P-V-8	1-3/4	4	JD-RE18730	9405	29.86
		Field Replacement Cyl	P-V-8	2	4	JD-AR105387	9405	29.08
LOADER BOOM LIFT		-192003	P-V-8	1-3/4	2-3/4	JD-AR105403		27.81

LGP - Low Ground Pressure LT - Long Track SLF - Super Long Front STD - Straight Dozer WT - Wide Track

Replacement Kits For

JOHN DEERE

JOHN DEERE

Loader Backhoes								
APPLICATION	CYL #	SERIAL #	CODE	ROD	BORE	KIT #	Arrangements	List \$
MODEL 310								
Backhoe Arrangement			9450, 9500					
LOADER BOOM LIFT		192004-	P-V-8	1-3/4	3	JD-RE18751		23.68
LOADER BUCKET TILT		All	P-V-8	1-3/4	3	JD-RE18751		23.68
STEERING		237996-	P-U-10	7/8	2	JD-RE18749		15.95
MODEL 310A, 310B								
Backhoe Arrangement			9450, 9500					
BACKHOE BOOM		-701219	P-V-8	2-1/4	4-1/2	JD-AR105355	9405, 9500	46.17
		701220-	P-V-14	2-1/4	4-1/2	JD-RE18764	9405	73.82
BACKHOE BUCKET		-701219	P-V-8	2-1/4	3-1/2	JD-RE18757	9405, 9500	33.94
		701220-	P-V-14	2-1/4	3-1/2	JD-RE18758	9405	64.69
BACKHOE CROWD		-700422	P-V-8	2	4	JD-AR105387	9405, 9500	29.08
		700423-	P-V-14	2	4	JD-RE18741		63.25
BACKHOE STABILIZER		-700422	P-V-8	1-3/4	3-1/2	JD-RE18754	9405	31.52
		700423-	P-V-14	1-3/4	3-1/2	JD-RE12912	9405	64.21
		All	P-V-8	1-3/4	3	JD-RE18751	9500	23.68
BACKHOE SWING		-346261	P-V-8	1-3/4	4	JD-RE18730	9405	29.86
		346262-700422	P-V-8	2	4	JD-AR105387	9405	29.08
		700423-	P-V-14	2	4	JD-RE18741	9405	63.25
LOADER BOOM LIFT		-291985	P-V-8	1-3/4	3	JD-RE18751		23.68
		291986-	P-V-8	1-3/4	3-1/4	JD-AR105402		25.72
LOADER BUCKET TILT		-291985	P-V-8	1-3/4	3	JD-RE18751		23.68
		291986-	P-V-8	1-1/2	3-1/4	JD-AR105429		23.30
STEERING		All	P-U-10	7/8	2	JD-RE18749		15.95
MODEL 310C								
Backhoe Arrangement			9450, 9500					
BACKHOE BOOM	AH150110		P-UB-1	56 mm		JD-AH149814		35.10
	AH150110		N-N-14		115 mm	JD-AH149846		76.78
	RE23999	-740892	N-N-14		115 mm	JD-AH149846		76.78
	RE23999	-740892	P-UB-1	50 mm		JD-RE20595		32.88
	RE31721	740893-	N-N-14		115 mm	JD-AH149846		76.78
	RE31721	740893-	P-UB-1	56 mm		JD-RE31716		45.04
BACKHOE BUCKET	AH147722		P-UB-1	50 mm		JD-AH148164		27.72
	AH147722		N-N-14		90 mm	JD-AH149843		43.14
	RE20829		P-UB-1	50 mm		JD-RE20595		32.88
BACKHOE CROWD	RE20829	-729080	N-N-14		90 mm	JD-AH149843		43.14
	AH138661	740539-	N-N-14		100 mm	JD-AH149844		54.45
BACKHOE STABILIZER	AH138661	740539-	P-UB-1	56 mm		JD-RE31716		45.04
	AH150119		P-UB-1	56 mm		JD-AH149814		35.10
	AH150119		N-N-14		100 mm	JD-AH149844		54.45
	AH150103		P-UB-1	45 mm		JD-AH149813		38.45
	AH150103		N-N-14		90 mm	JD-AH149843		43.14
	AH150392		P-UB-1	50 mm		JD-AH148164		27.72
BACKHOE STABILIZER	AH150392		N-N-14		100 mm	JD-AH149844		54.45
	AH150392		N-N-14		100 mm	JD-AH149844		54.45
	RE20830	-727315	N-N-14		90 mm	JD-AH149843		43.14
	RE20830	-727315	P-UB-1	45 mm		JD-RE20434		37.20
	RE26578	761935-	N-N-14		100 mm	JD-AH149844		54.45

LGP - Low Ground Pressure LT - Long Track SLF - Super Long Front STD - Straight Dozer WT - Wide Track

Replacement Kits For

JOHN DEERE

JOHN DEERE

Loader Backhoes								
APPLICATION	CYL #	SERIAL #	CODE	ROD	BORE	KIT #	Arrangements	List \$
MODEL 310C								
Backhoe Arrangement			9450, 9500					
BACKHOE STABILIZER	RE26578	761935-	P-UB-1	50 mm		JD-RE20595		32.88
	RE26990	727316-761934	N-N-14		90 mm	JD-AH149843		43.14
	RE26990	727316-761934	P-UB-1	45 mm		JD-RE20434		37.20
BACKHOE SWING	AH148696		P-UB-1	50 mm		JD-AH148164		27.72
	AH148696		N-N-14		100 mm	JD-AH149844		54.45
	RE20831		N-N-14		100 mm	JD-AH149844		54.45
	RE20831		P-UB-1	50 mm		JD-RE20595		32.88
	Replacement		N-N-14		100 mm	JD-AH137687		45.59
	Replacement		P-UB-1	50 mm		JD-RE20595		32.88
EXT. DIPPERSTICK	AH144391		P-UB-1	45 mm		JD-RE20434		37.20
	AH144391		N-N-10		80 mm	JD-RE37003		9.72
	AH154784		P-UB-1	45 mm		JD-AH149813		38.45
	AH154784		N-N-10		80 mm	JD-RE37003		9.72
	AT101011		I-U-4	1-1/4	2-1/2	JD-AT101377		49.95
LOADER BOOM	AH138930	774762-	N-N-14		80 mm	JD-AH149842		43.50
	AH138930	774762-	P-UB-1	45 mm		JD-RE20434		37.20
	AH154778		P-UB-1	45 mm		JD-AH149813		38.45
	AH154778		N-N-14		80 mm	JD-AH149842		43.50
	RE20825	-774761	N-N-14		80 mm	JD-AH149842		43.50
	RE20825	-774761	P-UB-1	45 mm		JD-RE20434		37.20
LOADER BUCKET	AH154793		P-UB-1	45 mm		JD-AH149813		38.45
	AH154793		N-N-14		90 mm	JD-AH149843		43.14
	RE20826		N-N-14		90 mm	JD-AH149843		43.14
	RE20826		P-UB-1	45 mm		JD-RE20434		37.20
MULTI-PURPOSE BUCKET	AT142578		P-U-10	2	3	JD-AT142582		29.07
STEERING			I-U-10	32 mm	60 mm	JD-AT108329		28.18
STEERING, HYDROSTATIC	AT76043		I-U-10	25 mm	50 mm	JD-AT78498		35.61
STEERING, POWER	AH139130		N-N-10		2	JD-AH137789		3.97
	AH139130		P-UB-1	25 mm		JD-RE21875		32.44
	AH154780		N-N-10		2	JD-AH137789		3.97
	AH154780		P-U-1	25 mm		JD-AU149810		31.63
	RE18712	-726006	N-N-10		2	JD-RE14551		7.40
	RE18712	-726006	P-U-1	1		JD-RE14552		8.60
	RE21961	726007-746966	N-N-14		50 mm	JD-RE21874		31.64
	RE21961	726007-746966	P-UB-1	25 mm		JD-RE21875		32.44
	RE33800	746967-	P-UB-1	25 mm		JD-RE21875		32.44
	RE33800	746967-	N-N-14		50 mm	JD-RE33803		34.48
MODEL 310D								
BACKHOE ARM			N-N-14		100 mm	JD-AH149844		54.45
			P-UB-1	56 mm		JD-RE31716		45.04
BACKHOE BOOM			N-N-14		115 mm	JD-AH149846		76.78
	RE31721	740893-	P-UB-1	56 mm		JD-RE31716		45.04
BACKHOE BUCKET			P-UB-1	50 mm		JD-AH148164		27.72
			N-N-14		90 mm	JD-AH149843		43.14
BACKHOE STABILIZER			N-N-14		100 mm	JD-AH137687		45.59

LGP - Low Ground Pressure LT - Long Track SLF - Super Long Front STD - Straight Dozer WT - Wide Track

Replacement Kits For

JOHN DEERE

JOHN DEERE

Loader Backhoes								
APPLICATION	CYL #	SERIAL #	CODE	ROD	BORE	KIT #	Arrangements	List \$
MODEL 310D								
BACKHOE STABILIZER			P-UB-1	50 mm		JD-AH148164		27.72
			N-N-14		100 mm	JD-AH149844		54.45
LOADER BOOM			N-N-14		80 mm	JD-AH149842		43.50
			P-UB-1	45 mm		JD-RE20434		37.20
LOADER BUCKET			N-N-14		90 mm	JD-AH149843		43.14
			P-UB-1	45 mm		JD-RE20434		37.20
SWING			P-UB-1	50 mm		JD-AH148164		27.72
			N-N-14		100 mm	JD-AH149844		54.45
MODEL 401C								
Backhoe Arrangement			9250, 9250A					
BACKHOE BOOM		All	P-V-8	2	4	JD-RE18732		29.99
BACKHOE BUCKET		All	P-V-8	1-3/4	3	JD-RE18751		23.68
BACKHOE CROWD		All	P-V-8	1-3/4	3-1/2	JD-RE18755		25.40
BACKHOE STABILIZER		All	P-V-8	1-3/4	3-1/2	JD-RE18754		31.52
BACKHOE SWING		39797-	P-U-10	1-3/4	3-1/2	JD-RE18756	9250A	31.35
		All	P-V-8	2	4	JD-RE18732	9250	29.99
LOADER BOOM LIFT		All	P-V-8	1-3/4	2-3/4	JD-RE19220		25.07
LOADER BUCKET TILT		All	P-V-8	1-1/4	2-1/2	JD-AR105453		23.06
MODEL 401D								
Backhoe Arrangement			9250B					
BACKHOE BOOM		All	N-N-14		4	JD-RE16118		51.12
		All	P-V-1	2		JD-RE16119		17.14
BACKHOE BUCKET		All	P-V-8	1-3/4	3	JD-RE18751		23.68
BACKHOE CROWD		All	P-V-8	1-3/4	3-1/2	JD-RE18755		25.40
BACKHOE STABILIZER		All	P-V-8	1-3/4	3-1/2	JD-RE18754		31.52
BACKHOE SWING		All	P-U-10	1-3/4	3-1/2	JD-RE18756		31.35
LOADER BOOM LIFT		Non-Self Level Bucket	P-V-8	1-3/4	2-3/4	JD-RE19220		25.07
		Self Level Bucket	P-V-1	1-3/4		JD-RE16209		20.07
		Self Level Bucket	N-N-14		3-1/4	JD-RE30816		42.24
LOADER BUCKET TILT		Non-Self Level Bucket	P-V-8	1-1/2	2-1/2	JD-RE19217		19.48
		Self Level Bucket	P-V-8	1-1/4	2-1/2	JD-AR105453		23.06
STEERING		All	P-U-10	7/8	2	JD-RE18749		15.95
MODEL 410								
Backhoe Arrangement			9410, 9500					
BACKHOE BOOM		All	P-V-8	2-1/4	4-1/2	JD-AR105355		46.17
		Field Replacement Check Piston	P-V-14	2-1/4	4-1/2	JD-RE18764		73.82
BACKHOE BUCKET		All	P-V-8	2-1/4	3-1/2	JD-RE18757		33.94
		Field Replacement Check Piston	P-V-14	2-1/4	3-1/2	JD-RE18758		64.69
BACKHOE CROWD		All	P-V-8	2-1/4	4-1/2	JD-AR105355	9410	46.17
		All	P-V-8	2	4	JD-AR105387	9500	29.08
		Field Replacement Check Piston	P-V-14	2-1/4	4-1/2	JD-RE18764	9410	73.82

LGP - Low Ground Pressure LT - Long Track SLF - Super Long Front STD - Straight Dozer WT - Wide Track

Replacement Kits For

JOHN DEERE

JOHN DEERE

Loader Backhoes								
APPLICATION	CYL #	SERIAL #	CODE	ROD	BORE	KIT #	Arrangements	List \$
MODEL 410								
Backhoe Arrangement			9410, 9500					
BACKHOE STABILIZER		All	P-V-8	1-3/4	3-1/2	JD-RE18754	9410	31.52
		All	P-V-8	1-3/4	3	JD-RE18751	9500	23.68
		Field Replacement Check Piston	P-V-14	1-3/4	3-1/2	JD-RE12912	9410	64.21
BACKHOE SWING		-303202	P-V-8	1-3/4	4	JD-RE18730	9410	29.86
		303203-	P-V-8	2	4	JD-AR105387	9410	29.08
		303203-	P-V-14	2	4	JD-RE18741	9410	63.25
LOADER BOOM LIFT		All	P-V-8	1-3/4	3-1/4	JD-AR105402		25.72
LOADER BUCKET TILT		All	P-V-8	1-1/2	3-1/4	JD-AR105429		23.30
MODEL 410B								
BACKHOE BOOM		All	P-V-1	2-1/4	-	JD-RE14208		24.51
		All	N-N-14		4-1/2	JD-RE14523		53.03
BACKHOE BUCKET		-711906	P-U-1	2-1/2		JD-RE14516		24.65
		-711906	N-N-14		3-1/2	JD-RE16076		49.55
		711907-	P-V-1	2-1/4		JD-RE14538		18.38
BACKHOE CROWD		711907-	N-N-14		3-1/2	JD-RE16076		49.55
		All	N-N-14		4	JD-RE16118		51.12
BACKHOE STABILIZER		All	P-V-1	2		JD-RE16119		17.14
		-719446	N-N-14		4	JD-RE16118		51.12
		-719446	P-V-1	2		JD-RE16119		17.14
BACKHOE SWING		719447-	P-UB-1	50 mm		JD-RE20595		32.88
		719447-	N-N-14		100 mm	JD-RE31139		60.67
		All	N-N-14		4	JD-RE16118		51.12
LOADER BOOM LIFT		All	P-V-1	2		JD-RE16119		17.14
		All	P-V-1	1-3/4		JD-RE16209		20.07
LOADER BUCKET TILT		All	N-N-14		3-1/4	JD-RE30816		42.24
		All	N-N-14		3-1/2	JD-RE14517		49.01
STEERING		All	P-V-1	1-3/4		JD-RE30874		18.66
		All	N-N-10		2	JD-RE14551		7.40
		All	P-U-1	1		JD-RE14552		8.60
MODEL 410C								
BACKHOE BOOM	AH135265	All	P-UB-1	63 mm		JD-RE25151		70.43
	AH135265	All	N-N-14		115 mm	JD-RE31140		75.50
	RE21962	All	P-UB-1	63 mm		JD-RE25151		70.43
	RE21962	All	N-N-14		115 mm	JD-RE31140		75.50
BACKHOE BUCKET	RE25622	All	P-UB-1	50 mm		JD-RE20595		32.88
BACKHOE CROWD	AH138661	740539-	N-N-14		100 mm	JD-AH137687		45.59
	AH138661	740539-	P-UB-1	56 mm		JD-RE31716		45.04
BACKHOE STABILIZER	RE26578	All	N-N-14		100 mm	JD-AH137687		45.59
	RE26578	All	P-UB-1	50 mm		JD-RE20595		32.88
BACKHOE SWING	RE15638	-737926	N-N-14		4	JD-RE16118		51.12
	RE15638	-737926	P-V-1	2		JD-RE16119		17.14
	RE33472	737927-	N-N-14		100 mm	JD-AH137687		45.59
	RE33472	737927-	P-UB-1	50 mm		JD-RE20595		32.88
DIPPER EXTENSION	AT101063	All	I-U-4	1-1/2	3	JD-AT79722		30.12

LGP - Low Ground Pressure LT - Long Track SLF - Super Long Front STD - Straight Dozer WT - Wide Track

Replacement Kits For

JOHN DEERE

JOHN DEERE

Loader Backhoes									
APPLICATION	CYL #	SERIAL #	CODE	ROD	BORE	KIT #	Arrangements	List \$	
MODEL 410C									
LOADER BOOM LIFT	AH138930	All	P-UB-1	45 mm		JD-RE20434		37.20	
	AH138930	All	N-N-14		80 mm	JD-RE31138		34.36	
	RE20825	All	P-UB-1	45 mm		JD-RE20434		37.20	
	RE20825	All	N-N-14		80 mm	JD-RE31138		34.36	
LOADER BUCKET TILT	RE20826	All	N-N-14		90 mm	JD-RE20430		31.04	
	RE20826	All	P-UB-1	45 mm		JD-RE20434		37.20	
	RE38227	All	N-N-14		90 mm	JD-RE20430		31.04	
	RE38227	All	P-UB-1	45 mm		JD-RE20434		37.20	
LOADER CLAM	AT142578	769393-	P-U-10	2	3	JD-AT142582		29.07	
	AT108335	749406-	I-U-10	32 mm	60 mm	JD-AT108329		28.18	
STEERING, HYDROSTATIC	AT76403	-749405	I-U-10	25 mm	50 mm	JD-AT78498		35.61	
STEERING, POWER	AH139130		N-N-10		2	JD-AH137789		3.97	
	AH139130		P-UB-1	25 mm		JD-RE21875		32.44	
	RE18712 Flame Cut Head		N-N-10		2	JD-RE14551		7.40	
	RE18712 Flame Cut Head		P-U-1	1		JD-RE14552		8.60	
	RE21961 Forged Head	-746966	N-N-14		50 mm	JD-RE21874		31.64	
	RE21961 Forged Head	-746966	P-UB-1	25 mm		JD-RE21875		32.44	
	RE33803	746967-XXXX	P-UB-1	25 mm		JD-RE21875		32.44	
	RE33803	746967-XXXX	N-N-14		50 mm	JD-RE33803		34.48	
	MODEL 410D								
	BACKHOE BOOM	AH135265 Std Boom	All	P-UB-1	63 mm		JD-RE25151		70.43
AH135265 Std Boom		All	N-N-14		115 mm	JD-RE31140		75.50	
RE15647 Hvy Lift Boom		All	N-N-14		5	JD-RE14744		65.47	
RE15647 Hvy Lift Boom		All	P-V-1	2-1/2		JD-RE14745		28.11	
BACKHOE BUCKET	RE25622	All	N-N-14		90 mm	JD-RE20430		31.04	
	RE25622	All	P-UB-1	50 mm		JD-RE20595		32.88	
BACKHOE CROWD	AH135266 Hvy Lift Boom	All	P-UB-1	63 mm		JD-RE25151		70.43	
	AH135266 Hvy Lift Boom	All	N-N-14		115 mm	JD-RE31140		75.50	
	AH138661 Std Boom	All	N-N-14		100 mm	JD-AH137687		45.59	
	AH138661 Std Boom	All	P-UB-1	56 mm		JD-RE31716		45.04	
BACKHOE STABILIZER	AH135635	All	P-UB-1	50 mm		JD-RE20595		32.88	
	AH135636	All	N-N-14		100 mm	JD-AH137687		45.59	
BACKHOE SWING	RE33472	All	N-N-14		100 mm	JD-AH137687		45.59	
	RE33472	All	P-UB-1	50 mm		JD-RE20595		32.88	
DIPPER EXT (1.2M)	AH141377		P-UB-1	45 mm		JD-RE20434		37.20	
	AH141377		N-N-10		80 mm	JD-RE37003		9.72	

LGP - Low Ground Pressure LT - Long Track SLF - Super Long Front STD - Straight Dozer WT - Wide Track

Replacement Kits For

JOHN DEERE

JOHN DEERE

Loader Backhoes								
APPLICATION	CYL #	SERIAL #	CODE	ROD	BORE	KIT #	Arrangements	List \$
MODEL 410D								
DIPPER EXT (1.2M)	AT10163		I-U-4	1-1/2	3	JD-AT79722		30.12
DIPPER EXT (1.5M)	AH141378		P-UB-1	45 mm		JD-RE20434		37.20
	AH141378		N-N-10		80 mm	JD-RE37003		9.72
	AT84174		I-U-4	1-1/2	3	JD-AT79722		30.12
LOADER BOOM LIFT	AH138931	All	N-N-14		90 mm	JD-RE20430		31.04
	AH138931	All	P-UB-1	45 mm		JD-RE20434		37.20
LOADER BUCKET TILT	RE38227	All	N-N-14		90 mm	JD-RE20430		31.04
	RE38227	All	P-UB-1	45 mm		JD-RE20434		37.20
LOADER CLAM	AT142578	All	P-U-10	2	3	JD-AT142582		29.07
STEERING, POWER	AH134479	780659-	P-UB-1	25 mm		JD-RE21875		32.44
	AH134479	780659-	N-N-10		2-1/2	JD-RE30100		4.21
	AH13930	-780658	N-N-10		2	JD-AH137789		3.97
	AH13930	-780658	P-UB-1	25 mm		JD-RE21875		32.44
MODEL 415B								
BACKHOE BOOM		All	P-V-1	2-1/4	-	JD-RE14208		24.51
		All	N-N-14		4-1/2	JD-RE14523		53.03
BACKHOE BUCKET		All	P-U-1	2-1/2		JD-RE14516		24.65
		All	N-N-14		3-1/2	JD-RE16076		49.55
BACKHOE CROWD		All	N-N-14		4	JD-RE16118		51.12
		All	P-V-1	2		JD-RE16119		17.14
BACKHOE STABILIZER		All	N-N-14		3	JD-RE14082		45.35
BACKHOE SWING		All	N-N-10		4	JD-RE14555		49.31
		All	P-U-1	2		JD-RE14556		16.28
LOADER BOOM LIFT		All	P-V-1	1-3/4		JD-RE16209		20.07
		All	N-N-14		3-1/4	JD-RE30816		42.24
LOADER BUCKET TILT		All	N-N-14		3-1/2	JD-RE14517		49.01
		All	P-V-1	1-3/4		JD-RE30874		18.66
STEERING		All	N-N-10		2	JD-RE14551		7.40
		All	P-U-1	1		JD-RE14552		8.60
MODEL 500A								
Backhoe Arrangement			95, 97, 9700					
BACKHOE BOOM		All	P-V-8	2-1/4	4-1/2	JD-RE10640		34.58
BACKHOE BUCKET		All	P-V-8	2-1/4	3-1/2	JD-RE18757		33.94
BACKHOE CROWD		All	P-V-8	2	4	JD-AR105387		29.08
BACKHOE STABILIZER		All	P-V-8	1-3/4	3	JD-RE18751	95	23.68
		All	P-V-8	1-3/4	3-1/2	JD-RE18754	97, 9700	31.52
BACKHOE SWING		All	P-V-8	1-3/4	4	JD-RE18730	9700	29.86
LOADER BOOM LIFT		All	P-V-8	1-1/2	2-3/4	JD-AR105430		21.58
LOADER BUCKET TILT		All	P-V-8	1-1/2	2-3/4	JD-AR105430		21.58
MODEL 500B								
Backhoe Arrangement			9900					
BACKHOE BOOM		All others	P-V-8	2-1/2	5-1/2	JD-AR105281		50.29
	AT37797	All	P-V-8	2-1/2	5-1/2	JD-RE13277		54.69
	AU43137	All	P-V-8	2-1/2	5-1/2	JD-AR105443		69.02
BACKHOE BUCKET		All	P-V-8	2-1/2	4	JD-AR96526		45.64
BACKHOE CROWD	AT35944		P-V-8	2-1/2	5-1/2	JD-AR105443		69.02
	AT38002	All	P-V-8	2-1/2	5-1/2	JD-RE18734		51.05

LGP - Low Ground Pressure LT - Long Track SLF - Super Long Front STD - Straight Dozer WT - Wide Track

Replacement Kits For

JOHN DEERE

JOHN DEERE

Loader Backhoes								
APPLICATION	CYL #	SERIAL #	CODE	ROD	BORE	KIT #	Arrangements	List \$
MODEL 500B								
Backhoe Arrangement			9900					
BACKHOE CROWD	AU42875	All	P-V-8	2-1/2	5-1/2	JD-AR105443		69.02
BACKHOE STABILIZER		All	P-V-8	2-1/2	4-1/2	JD-AR105441		48.25
BACKHOE SWING		All	P-V-8	2	4-1/2	JD-AR105384		33.74
LOADER BOOM LIFT		All	P-V-8	2	3-1/2	JD-AR105392		25.46
LOADER BUCKET TILT		All	P-V-8	1-3/4	3	JD-RE18751		23.68
MODEL 500C								
Backhoe Arrangement			9500, 9705					
BACKHOE BOOM		-700717	P-V-8	2-1/4	4-1/2	JD-AR105355	9500, 9705	46.17
		700718-	P-V-14	2-1/4	4-1/2	JD-RE18764	9705	73.82
BACKHOE BUCKET		-700717	P-V-8	2-1/4	3-1/2	JD-RE18757	9500, 9705	33.94
		700718-	P-V-14	2-1/4	3-1/2	JD-RE18758	9705	64.69
BACKHOE CROWD		-700717	P-V-8	2-1/4	4-1/2	JD-AR105355	9705	46.17
		700718-	P-V-14	2-1/4	4-1/2	JD-RE18764	9705	73.82
		All	P-V-8	2	4	JD-AR105387	9500	29.08
BACKHOE STABILIZER		-700717	P-V-8	1-3/4	3-1/2	JD-RE18754	9705	31.52
		700718-	P-V-14	1-3/4	3-1/2	JD-RE12912	9705	64.21
		All	P-V-8	1-3/4	3	JD-RE18751	9500	23.68
BACKHOE SWING		-303508	P-V-8	1-3/4	4	JD-RE18730	9705	29.86
		303509-700717	P-V-8	2	4	JD-AR105387	9705	29.08
		700718	P-V-14	2	4	JD-RE18741	9705	63.25
LOADER BOOM LIFT		All	P-V-8	1-3/4	3-1/4	JD-AR105402		25.72
LOADER BUCKET TILT		All	P-V-8	1-1/2	3-1/4	JD-AR105429		23.30
MODEL 510								
Backhoe Arrangement			9900					
BACKHOE BOOM		-155578	P-V-8	2-1/2	5-1/2	JD-AR105443	9900	69.02
		155579-249770	P-V-8	2-1/2	5-1/2	JD-RE13277	9900	54.69
		249771-700717	P-V-8	2-1/2	5-1/2	JD-AR105281	9900	50.29
		700718-	P-UB-10	2-1/2	5-1/2	JD-RE18745	9900	70.28
BACKHOE BUCKET		-700717	P-V-8	2-1/2	4	JD-AR96526	9900	45.64
		700718-	P-V-14	2-1/2	4	JD-RE18735	9900	73.58
BACKHOE CROWD		-155578	P-V-8	2-1/2	5-1/2	JD-AR105443	9900	69.02
		155579-700717	P-V-8	2-1/2	5-1/2	JD-RE18734	9900	51.05
		700718-	P-V-14	2-1/2	5-1/2	JD-RE18740		107.04
BACKHOE STABILIZER		-700717	P-V-8	2-1/2	4-1/2	JD-AR105441	9900	48.25
		700718-	N-N-14	-	4-1/2	JD-RE14094	9900	53.03
		700718-	P-V-1	2-1/2		JD-RE17345	9900	30.04
BACKHOE SWING		-700717	P-V-8	2	4-1/2	JD-AR105384	9900	33.74
		700718-	P-V-14	2	4-1/2	JD-RE19225	9900	68.78
LOADER BOOM LIFT		All	P-V-8	2	3-3/4	JD-AR105381		28.08
LOADER BUCKET TILT		All	P-V-8	2	3-1/2	JD-AR105392		25.46
LOADER CLAM		All	P-U-9	2	4	JD-JIC-G3229		29.21
MODEL 510B								
BACKHOE BOOM		All	N-N-14		5	JD-RE14744		65.47
		All	P-V-1	2-1/2		JD-RE14745		28.11
BACKHOE BUCKET		All	P-V-1	2-1/4		JD-RE14538		18.38
		All	N-N-14		3-1/2	JD-RE16076		49.55

LGP - Low Ground Pressure LT - Long Track SLF - Super Long Front STD - Straight Dozer WT - Wide Track

Replacement Kits For

JOHN DEERE

JOHN DEERE

Loader Backhoes								
APPLICATION	CYL #	SERIAL #	CODE	ROD	BORE	KIT #	Arrangements	List \$
MODEL 510B								
BACKHOE CROWD		All	N-N-14	-	4-1/2	JD-RE14094		53.03
		All	P-V-1	2-1/4	-	JD-RE14208		24.51
BACKHOE STABILIZER		-719455	N-N-14		4	JD-RE16118		51.12
		-719455	P-V-1	2		JD-RE16119		17.14
		719456-	P-UB-1	50 mm		JD-RE20595		32.88
		719456-	N-N-14		100 mm	JD-RE31139		60.67
BACKHOE SWING		All	N-N-14		4	JD-RE16118		51.12
		All	P-V-1	2		JD-RE16119		17.14
LOADER BOOM LIFT		All	N-N-14		3-1/2	JD-RE14517		49.01
		All	P-V-1	1-3/4		JD-RE16209		20.07
LOADER BUCKET TILT		All	N-N-14		4	JD-RE14567		52.56
		All	P-V-1	2		JD-RE16119		17.14
STEERING		All	N-N-10		2	JD-RE14551		7.40
		All	P-U-1	1		JD-RE14552		8.60
MODEL 510C								
BACKHOE BOOM	RE15647	All	N-N-14		5	JD-RE14744		65.47
	RE15647	All	P-V-1	2-1/2		JD-RE14745		28.11
BACKHOE BUCKET	RE25622	All	N-N-14		90 mm	JD-RE20430		31.04
	RE25622	All	P-UB-1	50 mm		JD-RE20595		32.88
BACKHOE CROWD	AH135266	-762814	P-UB-1	63 mm		JD-RE25151		70.43
	AH135266	-762814	N-N-14		115 mm	JD-RE31140		75.50
	AH142934	762815-	N-N-14		115 mm	JD-AH149846		76.78
	AH142934	762815-	P-UB-1	63 mm		JD-RE25151		70.43
	RE21965	-762814	P-UB-1	63 mm		JD-RE25151		70.43
	RE21965	-762814	N-N-14		115 mm	JD-RE31140		75.50
BACKHOE STABILIZER	RE26578	All	N-N-14		100 mm	JD-AH137687		45.59
	RE26578	All	P-UB-1	50 mm		JD-RE20595		32.88
BACKHOE SWING	RE15638	-737926	N-N-14		4	JD-RE16118		51.12
	RE15638	-737926	P-V-1	2		JD-RE16119		17.14
	RE33472	737927-	N-N-14		100 mm	JD-AH137687		45.59
	RE33472	737927-	P-UB-1	50 mm		JD-RE20595		32.88
DIPPER EXTENSION	AT84174	All	I-U-4	1-1/2	3	JD-AT79722		30.12
LOADER BOOM LIFT	AH138931		N-N-14		90 mm	JD-RE20430		31.04
	AH138931	All	P-UB-1	45 mm		JD-RE20434		37.20
	RE21959	All	N-N-14		90 mm	JD-RE20430		31.04
	RE21959	All	P-UB-1	45 mm		JD-RE20434		37.20
LOADER BUCKET TILT	RE21966	All	P-UB-1	50 mm		JD-RE20595		32.88
	RE38230	All	N-N-14		100 mm	JD-AH137687		45.59
LOADER CLAM	AT142578	769393-	P-U-10	2	3	JD-AT142582		29.07
STEERING, HYDROSTATIC	AT108335	749406-	I-U-10	32 mm	60 mm	JD-AT108329		28.18
	AT76403	-749405	I-U-10	25 mm	50 mm	JD-AT78498		35.61
STEERING, POWER	AH139130		N-N-10		2	JD-AH137789		3.97
	AH139130		P-UB-1	25 mm		JD-RE21875		32.44
	RE18712 Flame Cut Head		N-N-10		2	JD-RE14551		7.40

LGP - Low Ground Pressure LT - Long Track SLF - Super Long Front STD - Straight Dozer WT - Wide Track

Replacement Kits For

JOHN DEERE

JOHN DEERE

Loader Backhoes								
APPLICATION	CYL #	SERIAL #	CODE	ROD	BORE	KIT #	Arrangements	List \$
MODEL 510C								
STEERING, POWER	RE18712 Flame Cut Head		P-U-1	1		JD-RE14552		8.60
	RE21961 Forged Head	-746966	N-N-14		50 mm	JD-RE21874		31.64
	RE21961 Forged Head	-746966	P-UB-1	25 mm		JD-RE21875		32.44
	RE33803	746967-	P-UB-1	25 mm		JD-RE21875		32.44
	RE33803	746967-	N-N-14		50 mm	JD-RE33803		34.48
MODEL 510D								
BACKHOE BOOM	RE15647	All	N-N-14		5	JD-RE14744		65.47
	RE15647	All	P-V-1	2-1/2		JD-RE14745		28.11
BACKHOE BUCKET	RE25622	All	N-N-14		90 mm	JD-RE20430		31.04
	RE25622	All	P-UB-1	45 mm		JD-RE20434		37.20
BACKHOE CROWD	AH135266	All	P-UB-1	63 mm		JD-RE25151		70.43
	AH135266	All	N-N-14		115 mm	JD-RE31140		75.50
BACKHOE STABILIZER	AH135635	All	N-N-14		100 mm	JD-AH137687		45.59
	AH135635	All	P-UB-1	50 mm		JD-RE20595		32.88
	AH135636		N-N-14		100 mm	JD-AH137687		45.59
	AH135636		P-UB-1	50 mm		JD-RE20595		32.88
BACKHOE SWING	RE33472	All	N-N-14		100 mm	JD-AH137687		45.59
	RE33472	All	P-UB-1	50 mm		JD-RE20595		32.88
DIPPER EXTENSION	AH141378		P-UB-1	45 mm		JD-RE20434		37.20
	AH141378		N-N-10		80 mm	JD-RE37003		9.72
	AT84174		I-U-4	1-1/2	3	JD-AT79722		30.12
LOADER BOOM LIFT	AH138931	All	N-N-14		90 mm	JD-RE20430		31.04
	AH138931	All	P-UB-1	45 mm		JD-RE20434		37.20
LOADER BUCKET TILT	RE38230	All	N-N-14		100 mm	JD-AH137687		45.59
	RE38230	All	P-UB-1	50 mm		JD-RE20595		32.88
LOADER CLAM	AT142578	All	P-U-10	2	3	JD-AT142582		29.07
STEERING, POWER	AH134479	780659-	P-UB-1	25 mm		JD-RE21875		32.44
	AH134479	780659-	N-N-10		2-1/2	JD-RE30100		4.21
	AH139130	-780658	N-N-10		2	JD-AH137789		3.97
	AH139130	-780658	P-UB-1	25 mm		JD-RE21875		32.44
MODEL 515B								
BACKHOE BOOM		All	P-V-1	2-1/4	-	JD-RE14208		24.51
		All	N-N-14		4-1/2	JD-RE14523		53.03
BACKHOE BUCKET		All	P-V-1	2-1/4		JD-RE14538		18.38
		All	N-N-14		3-1/2	JD-RE16076		49.55
BACKHOE CROWD		All	P-U-1	2-1/4		JD-AH139417		25.71
		All	N-N-14		4-1/2	JD-RE14523		53.03
BACKHOE STABILIZER		All	N-N-14		3	JD-RE14082		45.35
BACKHOE SWING		All	N-N-10		4	JD-RE14555		49.31
LOADER BOOM LIFT		All	P-U-1	2		JD-RE14556		16.28
		All	N-N-14		3-1/2	JD-RE14517		49.01
LOADER BUCKET TILT		All	P-V-1	1-3/4		JD-RE16209		20.07
		All	N-N-14		4	JD-RE14567		52.56
		All	P-V-1	2		JD-RE16119		17.14

LGP - Low Ground Pressure LT - Long Track SLF - Super Long Front STD - Straight Dozer WT - Wide Track

Replacement Kits For

JOHN DEERE

JOHN DEERE

Loader Backhoes								
APPLICATION	CYL #	SERIAL #	CODE	ROD	BORE	KIT #	Arrangements	List \$
MODEL 515B								
STEERING		All	N-N-10		2	JD-RE14551		7.40
		All	P-U-1	1		JD-RE14552		8.60
MODEL 610B								
BACKHOE BOOM		All	N-N-14		5	JD-RE14744		65.47
		All	P-V-1	2-1/2		JD-RE14745		28.11
BACKHOE BUCKET		All	P-V-1	2-1/4		JD-RE14538		18.38
		All	N-N-14		3-1/2	JD-RE16076		49.55
BACKHOE CROWD		All	N-N-14	-	4-1/2	JD-RE14094		53.03
		All	P-V-1	2-1/4	-	JD-RE14208		24.51
BACKHOE STABILIZER		-719557	N-N-14		4	JD-RE16118		51.12
		-719557	P-V-1	2		JD-RE16119		17.14
		719558-	P-UB-1	50 mm		JD-RE20595		32.88
		719558-	N-N-14		100 mm	JD-RE31139		60.67
BACKHOE SWING		All	N-N-14		4	JD-RE16118		51.12
		All	P-V-1	2		JD-RE16119		17.14
LOADER BOOM LIFT		All	N-N-14		3-1/2	JD-RE14517		49.01
		All	P-V-1	1-3/4		JD-RE16209		20.07
LOADER BUCKET TILT		All	N-N-14		4	JD-RE14567		52.56
		All	P-V-1	2		JD-RE16119		17.14
STEERING		All	N-N-10		2	JD-RE14551		7.40
		All	P-U-1	1		JD-RE14552		8.60
MODEL 610C								
BACKHOE BOOM	RE15647	All	N-N-14		5	JD-RE14744		65.47
	RE15647	All	P-V-1	2-1/2		JD-RE14745		28.11
BACKHOE BUCKET	RE25622	All	N-N-14		90 mm	JD-RE20430		31.04
	RE25622	All	P-UB-1	50 mm		JD-RE20595		32.88
BACKHOE CROWD	AH135266		P-UB-1	63 mm		JD-RE25151		70.43
	AH135266		N-N-14		115 mm	JD-RE31140		75.50
	AH142934	762815-	N-N-14		115 mm	JD-AH149846		76.78
	AH142934	762815-	P-UB-1	63 mm		JD-RE25151		70.43
	RE21965	-762814	P-UB-1	63 mm		JD-RE25151		70.43
	RE21965	-762814	N-N-14		115 mm	JD-RE31140		75.50
	RE26578	All	N-N-14		100 mm	JD-AH137687		45.59
BACKHOE STABILIZER	RE26578	All	P-UB-1	50 mm		JD-RE20595		32.88
	RE15638	-737926	N-N-14		4	JD-RE16118		51.12
	RE15638	-737926	P-V-1	2		JD-RE16119		17.14
BACKHOE SWING	RE33472	737927	N-N-14		100 mm	JD-AH137687		45.59
	RE33472	737927	P-UB-1	50 mm		JD-RE20595		32.88
	AT84174	All	I-U-4	1-1/2	3	JD-AT79722		30.12
	AH138931	All	N-N-14		90 mm	JD-RE20430		31.04
DIPPER EXTENSION LOADER BOOM LIFT	AH138931	All	P-UB-1	45 mm		JD-RE20434		37.20
	RE21959	All	N-N-14		90 mm	JD-RE20430		31.04
	RE21959	All	P-UB-1	45 mm		JD-RE20434		37.20
LOADER BUCKET TILT	RE21966	All	N-N-14		100 mm	JD-AH137687		45.59
	RE21966	All	P-UB-1	50 mm		JD-RE20595		32.88
	RE38230	All	N-N-14		100 mm	JD-AH137687		45.59
	RE38230	All	P-UB-1	50 mm		JD-RE20595		32.88

LGP - Low Ground Pressure LT - Long Track SLF - Super Long Front STD - Straight Dozer WT - Wide Track

Replacement Kits For

JOHN DEERE

JOHN DEERE

Loader Backhoes								
APPLICATION	CYL #	SERIAL #	CODE	ROD	BORE	KIT #	Arrangements	List \$
MODEL 610C								
LOADER CLAM	AT142578	769393-	P-U-10	2	3	JD-AT142582		29.07
STEERING, HYDROSTATIC	AT108335	749406-	I-U-10	32 mm	60 mm	JD-AT108329		28.18
	AT76403	-749405	I-U-10	25 mm	50 mm	JD-AT78498		35.61
STEERING, POWER	AH139130		N-N-10		2	JD-AH137789		3.97
	AH139130		P-UB-1	25 mm		JD-RE21875		32.44
	RE18712 Flame Cut Head		N-N-10		2	JD-RE14551		7.40
	RE18712 Flame Cut Head		P-U-1	1		JD-RE14552		8.60
	RE21961 Forged Head	-746966	N-N-14		50 mm	JD-RE21874		31.64
	RE21961 Forged Head	-746966	P-UB-1	25 mm		JD-RE21875		32.44
	RE33803	746967-	P-UB-1	25 mm		JD-RE21875		32.44
	RE33803	746967-	N-N-14		50 mm	JD-RE33803		34.48
MODEL 710B								
BACKHOE BOOM		All	N-N-14		6	JD-RE14879		81.70
		All	P-U-1	2-3/4		JD-RE14880		28.65
BACKHOE BUCKET		All	P-U-1	2-1/2		JD-RE14516		24.65
		All	N-N-14		4	JD-RE14567		52.56
BACKHOE CROWD		All	N-N-14		5-1/2	JD-RE14877		79.82
		All	P-V-1	2-3/4		JD-RE14878		31.41
BACKHOE STABILIZER		All	N-N-14	-	4-1/2	JD-RE14094		53.03
		All	P-V-1	2-1/2		JD-RE14745		28.11
BACKHOE SWING		All	P-U-1	2-1/4		JD-AH139417		25.71
		All	N-N-14		4-1/2	JD-RE14523		53.03
LOADER BOOM LIFT		All	N-N-14		3-3/4	JD-RE14771		41.58
		All	P-V-1	2		JD-RE30817		20.90
LOADER BUCKET TILT		All	N-N-14		4-1/2	JD-RE14523		53.03
		All	P-V-1	2		JD-RE16119		17.14
STEERING		All	N-N-10		2-3/4	JD-RE14772		11.57
		All	P-U-1	1-1/4		JD-RE14773		15.07
MODEL 710C								
BACKHOE BOOM	AH136547		N-N-14		160 mm	JD-AH137210		72.20
	AH136547		P-UB-1	80 mm		JD-RE25152		91.43
	AH142928		N-N-14		160 mm	JD-AH137210		72.20
	AH142928		P-UB-1	80 mm		JD-RE25152		91.43
BACKHOE BUCKET	AH140866		P-UB-1	63 mm		JD-AH134477		66.72
	AH140866		N-N-14		100 mm	JD-AH149844		54.45
	AH142927		N-N-14		100 mm	JD-AH149844		54.45
	AH142927		P-UB-1	63 mm		JD-RE25151		70.43
BACKHOE CROWD	AH136539		N-N-14		140 mm	JD-AH137209		93.40
	AH136539		P-UB-1	70 mm		JD-RE37462		86.96
BACKHOE STABILIZER	AH154791		P-UB-1	63 mm		JD-AH149815		38.52
	AH154791		N-N-14		115 mm	JD-AH149846		76.78
	RE36942		N-N-14		115 mm	JD-AH149846		76.78

LGP - Low Ground Pressure LT - Long Track SLF - Super Long Front STD - Straight Dozer WT - Wide Track

Replacement Kits For

JOHN DEERE

JOHN DEERE

Loader Backhoes								
APPLICATION	CYL #	SERIAL #	CODE	ROD	BORE	KIT #	Arrangements	List \$
MODEL 710C								
BACKHOE STABILIZER	RE36942		P-UB-1	63 mm		JD-RE28899		67.19
BACKHOE SWING	AH139415		P-U-1	2-1/4		JD-AH139417		25.71
	AH139415		N-N-14		4-1/2	JD-RE14523		53.03
	AH141405		N-N-14		115 mm	JD-AH149846		76.78
	AH141405		P-UB-1	56 mm		JD-RE31716		45.04
	AH154781		P-UB-1	56 mm		JD-AH149814		35.10
	AH154781		N-N-14		115 mm	JD-AH149846		76.78
	AR104407	-704673	P-U-1	2-1/4		JD-AH139417		25.71
	AR104407	-704673	N-N-14		4-1/2	JD-RE14523		53.03
	RE15499	-704673	P-U-1	2-1/4		JD-AH139417		25.71
	RE15499	-704673	N-N-14		4-1/2	JD-RE14523		53.03
EXT. DIPPERSTICK	AH155668		P-UB-1	45 mm		JD-AH149813		38.45
	AH155668		N-N-10		80 mm	JD-RE37003		9.72
LOADER BOOM	AH154789		N-N-14		100 mm	JD-AH137687		45.59
	AH154789		P-UB-1	56 mm		JD-AH149814		35.10
	RE32557		N-N-14		100 mm	JD-AH137687		45.59
	RE32557		P-UB-1	56 mm		JD-RE31716		45.04
LOADER BUCKET	AH154792		P-UB-1	56 mm		JD-AH149814		35.10
	AH154792		N-N-14		115 mm	JD-AH149846		76.78
	RE37702		N-N-14		115 mm	JD-AH149846		76.78
	RE37702		P-UB-1	56 mm		JD-RE31716		45.04
MULTI-PURPOSE STEERING, POWER	AT142582	768252-	P-U-10	2	3	JD-AT142582		29.07
	AH154794		I-U-1	32 mm		JD-AH148823		26.75
	AH154794		N-N-14		70 mm	JD-RE20428		27.43
	RE38529		N-N-14		70 mm	JD-RE20428		27.43
	RE38529		P-UB-1	32 mm		JD-RE21873		31.66
MODEL 710D								
BACKHOE BOOM	AH142928		N-N-14		160 mm	JD-AH137210		72.20
	AH142928		P-UB-1	80 mm		JD-RE25152		91.43
BACKHOE BUCKET	AH142927		N-N-14		100 mm	JD-AH149844		54.45
	AH142927		P-UB-1	63 mm		JD-RE25151		70.43
BACKHOE CROWD	AH142926		N-N-14		140 mm	JD-AH137209		93.40
	AH142926		P-UB-1	70 mm		JD-AH142089		95.76
BACKHOE STABILIZER	AH154791	831990-	P-UB-1	63 mm		JD-AH149815		38.52
	AH154791	831990-	N-N-14		115 mm	JD-AH149846		76.78
	RE36942		P-UB-1	63 mm		JD-RE28899		67.19
	RE36942	-831989	N-N-14		115 mm	JD-AH149846		76.78
BACKHOE SWING	AH141405		N-N-14		115 mm	JD-AH149846		76.78
	AH141405		P-UB-1	56 mm		JD-RE31716		45.04
	AH154781		P-UB-1	56 mm		JD-AH149814		35.10
	AH154781		N-N-14		115 mm	JD-AH149846		76.78
EXT. DIPPERSTICK	AH146325		P-UB-1	45 mm		JD-RE20434		37.20
	AH146325		N-N-10		80 mm	JD-RE37003		9.72
	AH155668		P-UB-1	45 mm		JD-AH149813		38.45
	AH155668		N-N-10		80 mm	JD-RE37003		9.72
LOADER BOOM	AH154789		P-UB-1	56 mm		JD-AH149814		35.10
	AH154789		N-N-14		100 mm	JD-AH149844		54.45

LGP - Low Ground Pressure LT - Long Track SLF - Super Long Front STD - Straight Dozer WT - Wide Track

Replacement Kits For

JOHN DEERE

JOHN DEERE

Loader Backhoes								
APPLICATION	CYL #	SERIAL #	CODE	ROD	BORE	KIT #	Arrangements	List \$
MODEL 710D								
LOADER BOOM	RE32557		N-N-14		100 mm	JD-AH149844		54.45
	RE32557		P-UB-1	56 mm		JD-RE31716		45.04
LOADER BUCKET	AH154792		P-UB-1	56 mm		JD-AH149814		35.10
	AH154792		N-N-14		115 mm	JD-AH149846		76.78
	RE37702		N-N-14		115 mm	JD-AH149846		76.78
MULTI-PURPOSE STEERING, POWER	RE37702		P-UB-1	56 mm		JD-RE31716		45.04
	AT142578		P-U-10	2	3	JD-AT142582		29.07
	AH154794		I-U-1	32 mm		JD-AH148823		26.75
	AH154794		N-N-14		70 mm	JD-RE20428		27.43
	RE38529		N-N-14		70 mm	JD-RE20428		27.43
	RE38529		P-UB-1	32 mm		JD-RE21873		31.66
Loaders - Articulated								
APPLICATION	CYL #	SERIAL #	CODE	ROD	BORE	KIT #	Arrangements	List \$
MODEL 344E								
BOOM	AT122273	All	P-UB-10	60 mm	110 mm	JD-AT122564		81.81
BUCKET	AT122274	All	P-UB-10	60 mm	110 mm	JD-AT122564		81.81
STEERING	AT122275	All	P-UB-10	35 mm	60 mm	JD-AT122580		58.32
MODEL 444, 444C, 444CH								
Backhoe Arrangement			9450					
BACKHOE BOOM		All	P-V-8	2	4	JD-RE18732		29.99
BACKHOE BUCKET		All	P-V-8	1-3/4	3	JD-RE18751		23.68
BACKHOE CROWD		All	P-V-8	1-3/4	3-1/2	JD-RE18755		25.40
BACKHOE STABILIZER		All	P-V-8	1-3/4	3-1/2	JD-RE18754		31.52
BACKHOE SWING	-39796		P-U-10	1-3/4	3-1/2	JD-RE18756	9450	31.35
	39797-		P-U-10	1-3/4	3-1/2	JD-RE18756	9450	31.35
LOADER BOOM LIFT	-503064		P-V-8	2-1/4	5-1/4	JD-AR105346		39.11
	503065-		N-N-14	-	5-1/4	JD-RE14100		69.20
LOADER BUCKET TILT	503065-		P-V-1	2-1/4	-	JD-RE14208		24.51
	-503064		P-V-8	2-1/4	5-1/4	JD-AR105356		42.98
	503065-		N-N-14	-	5-1/4	JD-RE14100		69.20
LUMBER CLAMP	503065-		P-V-1	2-1/4		JD-RE14454		23.79
		All	P-V-8	2	4	JD-AR105387		29.08
MULTI-PURPOSE STEERING		All	P-V-8	2	4	JD-AR105387		29.08
	-505310		P-UB-10	1-1/2	3	JD-AR105272	Models 444 & 444CH only	16.11
	505311-		N-N-10		3	JD-RE18202	Models 444C, 444CH only	6.49
	505311-		P-V-1	1-1/2		JD-RE18203	Models 444C, 444CH only	17.77
	All		I-U-10	3-3/8	3-5/8	JD-RE19227	Model 444 only	27.64
MODEL 444D								
LOADER BOOM LIFT		All	N-N-14	-	5-1/4	JD-RE14100		69.20
		All	P-V-1	2-1/4	-	JD-RE14208		24.51
LOADER BUCKET TILT		All	N-N-14	-	5-1/4	JD-RE14100		69.20
		All	P-V-1	2-1/4		JD-RE14454		23.79
LUMBER FORK		All	P-V-8	2	4	JD-AR105387		29.08
MULTI-PURPOSE STEERING		All	P-V-8	2	4	JD-AR105387		29.08
		All	N-N-10		3	JD-RE18202		6.49

LGP - Low Ground Pressure LT - Long Track SLF - Super Long Front STD - Straight Dozer WT - Wide Track

JOHN DEERE

Replacement Kits For

JOHN DEERE

Loaders - Articulated								
APPLICATION	CYL #	SERIAL #	CODE	ROD	BORE	KIT #	Arrangements	List \$
MODEL 444D								
STEERING		All	P-V-1	1-1/2		JD-RE18203		17.77
MODEL 444E								
BOOM	AT121333	All	P-UB-10	60 mm	110 mm	JD-AT121500		93.46
BUCKET	AT121334	All	P-UB-10	65 mm	120 mm	JD-AT121501		94.91
STEERING	AT121335	All	P-UB-10	35 mm	65 mm	JD-AT121499		73.52
MODEL 544, 544A								
Backhoe Arrangement			93, 93A, 9305					
BACKHOE BOOM		-701219	P-V-8	2-1/4	4-1/2	JD-AR105355	9305	46.17
		701220-	P-V-14	2-1/4	4-1/2	JD-RE18764	9305	73.82
		All	P-V-8	2-1/4	4-1/2	JD-RE10640	93, 93A	34.58
BACKHOE BUCKET		-701219	P-V-8	2-1/4	3-1/2	JD-RE18757	93, 93A, 9305	33.94
		701220-	P-V-14	2-1/4	3-1/2	JD-RE18758	9305	64.69
BACKHOE CROWD		-701219	P-V-8	2	4	JD-AR105387	93, 93A, 9305	29.08
		701220-	P-V-14	2	4	JD-RE18741		63.25
BACKHOE STABILIZER		All	P-V-8	1-3/4	3-1/2	JD-RE18754	93, 93A	31.52
		All	P-V-8	2	4	JD-AR105387	9305	29.08
GRAPPLE		All	P-V-8	1-3/4	3-1/2	JD-RE18754		31.52
LOADER BOOM LIFT		All	P-V-8	2-1/4	5-1/4	JD-AR105346		39.11
LOADER BUCKET TILT		All	P-V-8	2	3-1/2	JD-RE18748		30.37
LOADER CLAM		453-	P-U-9	2	4	JD-JIC-G3229		29.21
LUMBER CLAMP		All	P-V-8	2-1/4	5-1/4	JD-AR105346		39.11
STEERING		All	I-U-1	3-3/8	3-5/8	JD-RE19226		29.32
		All	I-U-10	3-3/8	3-5/8	JD-RE19227		27.64
MODEL 544B								
Backhoe Arrangement			9305					
BACKHOE BOOM		-01219	P-V-8	2-1/4	4-1/2	JD-AR105355	9305	46.17
		701220-	P-V-14	2-1/4	4-1/2	JD-RE18764	9305	73.82
BACKHOE BUCKET		-701219	P-V-8	2-1/4	3-1/2	JD-RE18757	9305	33.94
		701220-	P-V-14	2-1/4	3-1/2	JD-RE18758	9305	64.69
BACKHOE CROWD		-701219	P-V-8	2	4	JD-AR105387	9305	29.08
		701220-	P-V-14	2	4	JD-RE18741	9305	63.25
BACKHOE STABILIZER		All	P-V-8	2	4	JD-AR105387		29.08
GRAPPLE		All	P-V-8	1-3/4	3-1/2	JD-RE18754		31.52
LOADER BOOM LIFT		All	P-V-8	2-1/4	5-1/4	JD-AR105346		39.11
LOADER BUCKET TILT		All	P-V-8	2-1/4	5-1/4	JD-AR105356		42.98
LUMBER CLAMP		-226223	P-V-8	2-1/4	5-1/4	JD-AR105346		39.11
		226224-	P-V-8	2	4	JD-AR105387		29.08
MULTI-PURPOSE		All	P-V-8	2	4	JD-AR105387		29.08
STEERING		-247599	I-U-1	3-3/8	3-5/8	JD-RE19226		29.32
		247600-	I-U-10	3-3/8	3-5/8	JD-RE19227		27.64
		All	I-U-10	3-3/8	3-5/8	JD-RE19227		27.64
MODEL 544C								
Backhoe Arrangement			9450					
BACKHOE BOOM		All	P-V-8	2	4	JD-RE18732		29.99
BACKHOE BUCKET		All	P-V-8	1-3/4	3	JD-RE18751		23.68
BACKHOE CROWD		All	P-V-8	1-3/4	3-1/2	JD-RE18755		25.40
BACKHOE STABILIZER		All	P-V-8	1-3/4	3-1/2	JD-RE18754		31.52

LGP - Low Ground Pressure LT - Long Track SLF - Super Long Front STD - Straight Dozer WT - Wide Track

Replacement Kits For

JOHN DEERE

JOHN DEERE

Loaders - Articulated								
APPLICATION	CYL #	SERIAL #	CODE	ROD	BORE	KIT #	Arrangements	List \$
MODEL 544C								
Backhoe Arrangement			9450					
BACKHOE SWING		All	P-U-10	1-3/4	3-1/2	JD-RE18756		31.35
LOADER BOOM LIFT		504463-	P-V-1	2-1/2		JD-RE13745		23.91
		504463-	N-N-14		5-1/2	JD-RE14910		79.82
LOADER BUCKET TILT		504664-	N-N-14		5-1/2	JD-RE14910		79.82
LUMBER FORK		All	P-V-8	2	4	JD-AR105387		29.08
MULTI-PURPOSE		All	P-V-8	2	4	JD-AR105387		29.08
STEERING		-505253	P-UB-10	1-1/2	3	JD-AR105272		16.11
		505254-	N-N-10		3	JD-RE18202		6.49
		505254-	P-V-1	1-1/2		JD-RE18203		17.77
MODEL 544D								
LOADER BOOM LIFT		All	P-V-1	2-1/2		JD-RE13745		23.91
		All	N-N-14		5-1/2	JD-RE14910		79.82
LOADER BUCKET		All	N-N-14		5-1/2	JD-RE14910		79.82
LUMBER FORK		All	P-V-8	2	4	JD-RE18733		24.52
MULTI-PURPOSE		All	P-V-8	2	4	JD-AR105387		29.08
STEERING		All	N-N-10		3	JD-RE18202		6.49
		All	P-V-1	1-1/2		JD-RE18203		17.77
MODEL 544E, 544E LL, 544E TC								
BOOM	AH136532	All	N-N-14		125 mm	JD-AH137208		84.52
	AH136532	All	P-UB-1	63 mm		JD-RE25151		70.43
	AH136534		N-N-14		125 mm	JD-AH137208		84.52
	AH136534		P-UB-1	63 mm		JD-RE25151		70.43
BUCKET	AH136537	All	N-N-14		140 mm	JD-AH137209		93.40
	AH136537	All	P-UB-1	63 mm		JD-RE25151		70.43
	AH136544	All	N-N-14		160 mm	JD-AH137210		72.20
	AH136544	All	P-UB-1	80 mm		JD-RE25152		91.43
	AH139262		N-N-14		140 mm	JD-AH137209		93.40
	AH139262		P-UB-1	63 mm		JD-RE25151		70.43
STEERING	RE27701	All	N-N-14		70 mm	JD-RE20428		27.43
	RE27701	All	P-UB-1	40 mm		JD-RE20433		37.00
MODEL 544G								
BOOM			N-N-14		125 mm	JD-AH137208		84.52
			P-UB-1	63 mm		JD-RE25151		70.43
BUCKET			N-N-14		140 mm	JD-AH137209		93.40
			P-UB-1	63 mm		JD-RE25151		70.43
STEERING			N-N-14		70 mm	JD-RE20428		27.43
			P-UB-1	40 mm		JD-RE20433		37.00
MODEL 544H, 544H LL								
BOOM	AH147533	-570068	P-UB-1	63 mm		JD-AH149815		38.52
	AH147533	-570068	N-N-14		115 mm	JD-AH163671		69.10
	AH163629	570069-	P-UB-1	63 mm		JD-AH149815		38.52
	AH163629	570069-	N-N-14		115 mm	JD-AH163671		69.10
BUCKET	AH152676	All	N-N-14		125 mm	JD-AH149848		108.17
	AH152676	All	P-UB-1	75 mm		JD-AH154570		43.85
	AH153921	All	N-N-14		110 mm	JD-AH149845		68.69
	AH153921	All	P-UB-1	70 mm		JD-AH156466		35.41

LGP - Low Ground Pressure LT - Long Track SLF - Super Long Front STD - Straight Dozer WT - Wide Track

Replacement Kits For

JOHN DEERE

JOHN DEERE

Loaders - Articulated								
APPLICATION	CYL #	SERIAL #	CODE	ROD	BORE	KIT #	Arrangements	List \$
MODEL 544H, 544H LL								
STEERING	AH147586	-568522	P-UB-14	40 mm	63 mm	JD-AH153497		83.41
	AH160118	568523-	I,P-UB-1	40 mm		JD-AH149194		32.09
	AH160118	568523-	N-N-14		63 mm	JD-AH161590		58.94
MODEL 624E, 624G								
BOOM	AH136535	All	N-N-14		140 mm	JD-AH137209		93.40
	AH136535	All	P-UB-1	63 mm		JD-RE25151		70.43
BUCKET	AH136542	All	N-N-14		160 mm	JD-AH137210		72.20
	AH136542	All	P-UB-1	80 mm		JD-RE25152		91.43
STEERING	RE36926	All	P-UB-1	45 mm		JD-RE20434		37.20
	RE36926	All	N-N-14		80 mm	JD-RE31138		34.36
MODEL 644, 644A								
Backhoe Arrangement			93, 93A, 9305					
BACKHOE BOOM		-701219	P-V-8	2-1/4	4-1/2	JD-AR105355	9305	46.17
		701220-	P-V-14	2-1/4	4-1/2	JD-RE18764	9305	73.82
		All	P-V-8	2-1/4	4-1/2	JD-RE10640	93, 93A	34.58
BACKHOE BUCKET		-701219	P-V-8	2-1/4	3-1/2	JD-RE18757	93, 93A, 9305	33.94
		701220-	P-V-14	2-1/4	3-1/2	JD-RE18758	9305	64.69
BACKHOE CROWD		-701219	P-V-8	2	4	JD-AR105387	93, 93A, 9305	29.08
		701220-	P-V-14	2	4	JD-RE18741	9305	63.25
BACKHOE STABILIZER			P-V-8	2	4	JD-AR105387	9305	29.08
		All	P-V-8	1-3/4	3-1/2	JD-RE18754	93, 93A	31.52
LOADER BOOM LIFT		All	P-V-8	2-3/4	6-1/4	JD-RE18744		91.30
LOADER BUCKET TILT		All	P-V-8	2-1/4	4-1/2	JD-AR105355		46.17
LOADER CLAM		303-	P-U-9	2	4	JD-JIC-G3229		29.21
LUMBER CLAMP		All	P-V-8	2-1/4	5-1/4	JD-AR105346		39.11
STEERING LH			P-UB-10	3-3/4	4	JD-AT34933		23.53
STEERING RH		All	P-UB-10	3-3/4	4	JD-AT34932		25.57
MODEL 644B								
LOADER BOOM LIFT		All	P-V-8	2-3/4	6-1/4	JD-RE18744		91.30
LOADER BUCKET TILT		All	P-V-8	2-3/4	6-1/4	JD-RE18744		91.30
LUMBER CLAMP		All	P-V-8	2-1/4	5-1/4	JD-AR105346		39.11
		All	P-V-8	2	4	JD-AR105387		29.08
MULTI-PURPOSE		All	P-V-8	2	4	JD-AR105387		29.08
STEERING		-247612	P-UB-10	3-3/4	4	JD-AT34933		23.53
		247613-	P-UB-10	3-3/4	4	JD-AT34932		25.57
		All	P-UB-10	3-3/4	4	JD-AT34932		25.57
MODEL 644C								
LOADER BOOM LIFT		505377-	N-N-14		6-1/4	JD-RE14022		86.50
		505377-	P-V-1	2-3/4		JD-RE16991		54.06
LOADER BUCKET TILT		505377-	N-N-14		6-1/4	JD-RE14022		86.50
		505377-	P-V-1	3		JD-RE16992		41.09
LUMBER FORK		All	P-V-8	2	4	JD-AR105387		29.08
MULTI-PURPOSE		All	P-V-8	2	4	JD-AR105387		29.08
STEERING		All	N-N-10		3-1/2	JD-RE17097		8.47
		All	P-V-1	1-3/4		JD-RE30874		18.66
MODEL 644D								
LOADER BOOM LIFT		All	N-N-14		6-1/4	JD-RE14022		86.50

LGP - Low Ground Pressure LT - Long Track SLF - Super Long Front STD - Straight Dozer WT - Wide Track

Replacement Kits For

JOHN DEERE

JOHN DEERE

Loaders - Articulated								
APPLICATION	CYL #	SERIAL #	CODE	ROD	BORE	KIT #	Arrangements	List \$
MODEL 644D								
LOADER BOOM LIFT		All	P-V-1	2-3/4		JD-RE16991		54.06
LOADER BUCKET TILT		All	N-N-14		6-1/4	JD-RE14022		86.50
		All	P-V-1	3		JD-RE16992		41.09
LUMBER FORK		All	P-V-8	2	4	JD-RE18733		24.52
MULTI-PURPOSE		All	P-V-8	2	4	JD-AR105387		29.08
STEERING		All	N-N-14		90 mm	JD-RE20430		31.04
		All	P-UB-1	45 mm		JD-RE20434		37.20
MODEL 644E, 644ER								
LOADER BOOM LIFT	AH136545	All	N-N-14		160 mm	JD-AH137210		72.20
	AH136545	All	P-UB-1	80 mm		JD-RE25152		91.43
	AH136546	All	N-N-14		160 mm	JD-AH137210		72.20
LOADER BUCKET TILT	AH136546	All	P-UB-1	80 mm		JD-RE25152		91.43
	AH136549	All	N-N-14		180 mm	JD-AH137211		82.83
	AH136549	All	P-UB-1	80 mm		JD-RE25152		91.43
	AH136551	All	N-N-14		180 mm	JD-AH137211		82.83
STEERING	AH136551	All	P-UB-1	80 mm		JD-RE25152		91.43
	RE24865	All	N-N-14		90 mm	JD-RE20430		31.04
	RE24865	All	P-UB-1	45 mm		JD-RE20434		37.20
MODEL 644G								
LOADER BOOM LIFT	AH139265	All	N-N-14		160 mm	JD-AH137210		72.20
	AH139265	All	P-UB-1	80 mm		JD-RE25152		91.43
LOADER BUCKET TILT	AH139266	All	N-N-14		180 mm	JD-AH137211		82.83
	AH139266	All	P-UB-1	80 mm		JD-RE25152		91.43
STEERING	AH150098	All	P-UB-1	45 mm		JD-AH149813		38.45
	AH150098	All	N-N-14		90 mm	JD-AH149843		43.14
	RE24865	All	N-N-14		90 mm	JD-AH149843		43.14
	RE24865	All	P-UB-1	45 mm		JD-RE20434		37.20
MODEL 744E								
LOADER BOOM LIFT	AT137814	All	P-UB-10	95 mm	170 mm	JD-AT138138		179.48
	AT161735	All	P-UB-10	95 mm	170 mm	JD-AT138138		179.48
LOADER BUCKET TILT	AT137796	All	P-UB-10	100 mm	200 mm	JD-AT138137		226.93
STEERING	AT137406	All	P-UB-10	50 mm	100 mm	JD-AT138119		104.57
	AT158546	All	P-UB-10	50 mm	100 mm	JD-AT138119		104.57
MODEL 844								
BOOM		507993-510358	N-N-14		7-1/2	JD-RE14033		105.84
		507993-510358	P-V-1	3-3/4		JD-RE15708		67.03
BUCKET		510359-	N-N-14		7-1/2	JD-RE14033		105.84
		510359-	P-U-1	3-3/4		JD-RE21202		116.70
		508226-510358	N-N-14		7-1/2	JD-RE14033		105.84
		508226-510358	P-V-1	3-3/4		JD-RE15708		67.03
		510359-	N-N-14		7-1/2	JD-RE14033		105.84
		510359-	P-U-1	3-3/4		JD-RE21202		116.70
STEERING		All	P-V-8	2	3-3/4	JD-AR105381		28.08
MODEL TC54H								
BOOM	AH147533	-570068	P-UB-1	63 mm		JD-AH149815		38.52
	AH147533	-570068	N-N-14		115 mm	JD-AH163671		69.10
	AH163629	570069-	P-UB-1	63 mm		JD-AH149815		38.52

LGP - Low Ground Pressure LT - Long Track SLF - Super Long Front STD - Straight Dozer WT - Wide Track

Replacement Kits For

JOHN DEERE

JOHN DEERE

Loaders - Articulated								
APPLICATION	CYL #	SERIAL #	CODE	ROD	BORE	KIT #	Arrangements	List \$
MODEL TC54H								
BOOM	AH163629	570069-	N-N-14		115 mm	JD-AH163671		69.10
BUCKET	AH153921	All	N-N-14		110 mm	JD-AH149845		68.69
	AH153921	All	P-UB-1	70 mm		JD-AH156466		35.41
STEERING	AH147586	-568522	P-UB-14	40 mm	63 mm	JD-AH153497		83.41
	AH160118	568523-	I,P-UB-1	40 mm		JD-AH149194		32.09
	AH160118	568523-	N-N-14		63 mm	JD-AH161590		58.94
Loaders - Wheeled								
APPLICATION	CYL #	SERIAL #	CODE	ROD	BORE	KIT #	Arrangements	List \$
MODEL 300								
Loader Arrangement			7300, 7320					
Backhoe Arrangement			92, 9250					
BACKHOE BOOM		-8249	P-V-8	2	4	JD-AR105387	9250	29.08
		8250-	P-V-8	2	4	JD-RE18732	9250	29.99
		All	P-V-8	1-3/4	3-1/2	JD-RE18754		31.52
BACKHOE BUCKET		All	P-V-8	1-3/4	3	JD-RE18751		23.68
BACKHOE CROWD		All	P-V-8	1-3/4	3-1/2	JD-RE18754		31.52
		All	P-V-8	1-3/4	3-1/2	JD-RE18755	9250	25.40
BACKHOE STABILIZER		All	P-V-8	1-3/4	3-1/2	JD-RE18754		31.52
BACKHOE SWING		-8249	P-V-8	2	4	JD-AR105393	9250	36.76
		8250-	P-V-8	2	4	JD-RE18732	9250	29.99
		All	P-V-8	1-3/4	3-1/2	JD-AR105412		40.24
LOADER BOOM LIFT		All	P-V-8	1-1/2	2-1/2	JD-RE19217	7320	19.48
LOADER BUCKET TILT		YR. 1969-	P-U-8	1-1/2	2-1/4	JD-AR96532	7300	15.90
		All	P-V-8	1-1/2	2-1/2	JD-RE19217	7320	19.48
		YR. 1967-	P-V-8	1-1/4	2-1/2	JD-AR105453	7300	23.06
MODEL 400, 401A								
Loader Arrangement			7300, 7320					
Backhoe Arrangement			92, 9250					
BACKHOE BOOM		-8249	P-V-8	2	4	JD-AR105387	9250	29.08
		8250-	P-V-8	2	4	JD-RE18732	9250	29.99
		All	P-V-8	1-3/4	3-1/2	JD-RE18754	92	31.52
		All	P-V-8	2-1/4	4-1/2	JD-RE10640	94, 95, 95A, 9400	34.58
BACKHOE BUCKET		All	P-V-8	1-3/4	3	JD-RE18751	92, 9250	23.68
		All	P-V-8	2-1/4	3-1/2	JD-RE18757	94, 95, 95A, 9400	33.94
BACKHOE CROWD		All	P-V-8	1-3/4	3-1/2	JD-RE18754	92	31.52
		All	P-V-8	1-3/4	3-1/2	JD-RE18755	9250	25.40
		All	P-V-8	2	4	JD-AR105387	94, 95, 95A, 9400	29.08
BACKHOE STABILIZER		All	P-V-8	1-3/4	3-1/2	JD-RE18754	92, 94, 9250, 9400	31.52
		All	P-V-8	1-3/4	3	JD-RE18751	95, 95A	23.68
BACKHOE SWING		-8249	P-V-8	2	4	JD-AR105393	9250	36.76
		8250-	P-V-8	2	4	JD-RE18732	9250	29.99
		All	P-V-8	1-3/4	3-1/2	JD-AR105412	92	40.24
		All	P-V-8	1-3/4	4	JD-RE18730	9400	29.86
LOADER BOOM LIFT		4601-	P-V-8	1-3/4	2-3/4	JD-RE19220		25.07

LGP - Low Ground Pressure LT - Long Track SLF - Super Long Front STD - Straight Dozer WT - Wide Track

Replacement Kits For

JOHN DEERE

JOHN DEERE

Loaders - Wheeled								
APPLICATION	CYL #	SERIAL #	CODE	ROD	BORE	KIT #	Arrangements	List \$
MODEL 400, 401A								
		Loader Arrangement	7300, 7320					
		Backhoe Arrangement	92, 9250					
LOADER BOOM LIFT		YR 1967-S/N 4600	P-V-8	1-1/2	2-1/2	JD-RE19217		19.48
LOADER BUCKET TILT		All	P-V-8	1-1/4	2-1/2	JD-AR105453		23.06
Motor Graders								
APPLICATION	CYL #	SERIAL #	CODE	ROD	BORE	KIT #	Arrangements	List \$
MODEL 570, 570A, 570B								
BLADE LIFT		All	P-V-8	1-3/4	3	JD-RE18751		23.68
BLADE PITCH		All	P-V-8	1-1/4	2-1/2	JD-AR105453		23.06
BLADE SIDESHIFT		All	P-V-8	1-1/2	2-1/2	JD-RE19217		19.48
CIRCLE SIDESHIFT		All	P-V-8	1-3/4	3	JD-RE18751		23.68
SCARIFIER & SNOW PLOW LIFT		All	P-V-8	1-3/4	4	JD-RE10223		25.79
STEERING, REAR		All	P-V-8	1-1/4	3	JD-AR105454		24.76
WHEEL LEAN		All	P-V-8	1-1/4	3	JD-AR105454		24.76
MODEL 670,670A,670B,672A,672B								
BLADE LIFT		All	P-V-8	2	3-1/4	JD-RE18747		28.26
BLADE SIDESHIFT		All	P-V-10	1-1/2	3-1/2	JD-RE18742		37.25
BLADE TILT		All	P-V-8	1-3/4	4	JD-RE18736		27.44
CIRCLE SIDESHIFT		All	P-V-8	2	3-1/4	JD-RE18747		28.26
FRONT MOUNTED EQ.		All	P-V-8	2	5	JD-RE18743		35.14
RIPPER		All	P-V-8	2-1/4	5-1/4	JD-AR105346		39.11
SCARIFIER		All	P-V-8	2	5	JD-RE18743		35.14
STEERING, FRONT		All	P-U-8	1-1/4	3	JD-RE18750		19.42
STEERING, REAR		All	P-V-8	1-3/4	3-1/2	JD-RE18754	Models 670, 670A, 672A only	31.52
		All	N-N-14		90 mm	JD-RE20430	Models 670B, 672B only	31.04
		All	P-UB-1	45 mm		JD-RE20434	Models 670B, 672B only	37.20
WHEEL LEAN		All	P-V-8	2	4	JD-RE18733		24.52
MODEL 770,770A,770B,772A,772B								
BLADE LIFT		All	P-V-8	2	3-1/2	JD-RE18748		30.37
BLADE SIDESHIFT		All	P-V-10	1-1/2	3-1/2	JD-RE18742		37.25
BLADE TILT		All	P-V-8	1-3/4	4	JD-RE18736		27.44
CIRCLE SIDESHIFT		All	P-V-8	1-3/4	3-1/2	JD-RE18754		31.52
FRONT MOUNTED EQ.		All	P-V-8	2	5	JD-RE18743		35.14
RIPPER		All	P-V-8	2-1/4	5-1/4	JD-AR105346		39.11
SCARIFIER		All	P-V-8	2	5	JD-RE18743		35.14
STEERING, FRONT		All	P-U-8	1-1/4	3	JD-RE18750		19.42
STEERING, REAR		All	P-V-8	2	4	JD-RE18733		24.52
WHEEL LEAN		All	P-V-8	2	4	JD-RE18733		24.52
Scrapers								
APPLICATION	CYL #	SERIAL #	CODE	ROD	BORE	KIT #	Arrangements	List \$
MODEL 760								
BOWL LIFT		All	P-V-8	2	4	JD-AR105387		29.08
SCARIFIER		All	P-V-8	1-1/2	3	JD-AR105722		25.71

LGP - Low Ground Pressure LT - Long Track SLF - Super Long Front STD - Straight Dozer WT - Wide Track

Replacement Kits For

JOHN DEERE

JOHN DEERE

Scrapers									
APPLICATION	CYL #	SERIAL #	CODE	ROD	BORE	KIT #	Arrangements	List \$	
MODEL 760									
SLIDING FLOOR		-1000	P-V-8	2-1/4	4-1/2	JD-AR105355		46.17	
		1001-	P-V-8	2-1/4	4-1/2	JD-AR105351		37.50	
MODEL 760A									
BOWL LIFT		All	P-V-8	2	4	JD-AR105387		29.08	
EJECTOR GATE	RE19217		P-V-8	1-1/2	2-1/2	JD-RE19217		19.48	
SCARIFIER		All	P-V-8	1-1/2	3	JD-AR105722		25.71	
SLIDING FLOOR		-2505	P-V-8	2-1/4	4-1/2	JD-AR105351		37.50	
		2506-	P-V-8	2-1/4	5	JD-RE18759		45.52	
MODEL 762,762A,762B									
BOWL LIFT		All	P-V-8	2	4-1/2	JD-RE18737		31.08	
EJECTOR GATE		All	P-V-8	1-1/2	2-1/2	JD-RE19217		19.48	
SLIDING FLOOR		All	P-V-8	2-1/4	5-1/4	JD-AR105346		39.11	
STEERING		All	P-V-10	2	3-1/2	JD-RE18765		32.34	
STEERING (Follow-Up)		All	P-U-10	1/2	1	JD-AH65915	Models 762, 762A only	6.38	
MODEL 860,860A,860B									
BOWL LIFT		All	P-V-8	2	5	JD-RE18743		35.14	
EJECTOR GATE		All	P-V-8	1-3/4	3	JD-RE18752		24.50	
SLIDING FLOOR		All	P-V-8	2-1/2	5-1/4	JD-RE18746		37.50	
STEERING		All	P-V-10	2	4	JD-RE18738		20.63	
STEERING (Follow-Up)		All	P-OB-10	11/16	1-3/4	JD-AU43367		7.03	
MODEL 862									
AXLE SUSPENSION			N-N-14		4	JD-RE16118		51.12	
			P-V-1	2		JD-RE16119		17.14	
BOWL LIFT			P-V-8	2	5	JD-RE18743		35.14	
EJECTOR GATE		-4283	P-V-8	1-3/4	3	JD-RE18752		24.50	
		4283-781780	P-U-8	2	3	JD-RE19218		28.46	
SLIDING FLOOR			P-V-8	2-1/2	5-1/4	JD-RE18746		37.50	
STEERING			P-V-10	2	4	JD-RE18738		20.63	
STEERING (Follow-Up)			P-U-10	1/2	1	JD-AH65915		6.38	
MODEL 862B									
BOWL LIFT		781781-	N-N-14		140 mm	JD-AH137209		93.40	
		781781-	P-UB-1	63 mm		JD-RE25151		70.43	
EJECTOR GATE		4283-781780	P-U-8	2	3	JD-RE19218		28.46	
		781781-	P-UB-1	50 mm		JD-RE20595		32.88	
STEERING		781781-	N-N-14		80 mm	JD-RE31138		34.36	
			P-V-10	2	4	JD-RE18738		20.63	
		RE18738	781781-	N-N-14		100 mm	JD-AH137687		45.59
		RE18738	781781-	P-UB-1	50 mm		JD-RE20595		32.88
MODEL 5010									
BOWL LIFT		All	P-V-8	2	4	JD-AR105387		29.08	
EJECTOR GATE		All	P-OB-8	1-1/2	2-1/2	JD-AR99785		13.45	
		All	P-V-8	1-1/2	2-1/2	JD-RE19217		19.48	
SCARIFIER		All	P-V-8	1-1/2	3	JD-AR105722		25.71	
SLIDING FLOOR		All	P-V-8	2	4-1/2	JD-AR105384		33.74	

LGP - Low Ground Pressure LT - Long Track SLF - Super Long Front STD - Straight Dozer WT - Wide Track

Replacement Kits For

JOHN DEERE

JOHN DEERE

Skidders								
APPLICATION	CYL #	SERIAL #	CODE	ROD	BORE	KIT #	Arrangements	List \$
MODEL 340D								
BLADE LIFT		All	P-V-1	1-1/2		JD-RE14088		16.40
			All	N-N-14		3-1/2	JD-RE16076	
STEERING		All	P-V-10	1-3/4	2-3/4	JD-AR105537		27.68
MODEL 440, 440A, 440B								
Backhoe Arrangement			93, 93A, 95, 95A					
BACKHOE BOOM		All	P-V-8	2-1/4	4-1/2	JD-RE10640		34.58
BACKHOE BUCKET		All	P-V-8	2-1/4	3-1/2	JD-RE18757		33.94
BACKHOE CROWD		All	P-V-8	2	4	JD-AR105387		29.08
BACKHOE STABILIZER		All	P-V-8	1-3/4	3-1/2	JD-RE18754	93, 93A	31.52
		All	P-V-8	1-3/4	3	JD-RE18751	95, 95A	23.68
FRONT BLADE		All	P-V-8	1-1/2	3	JD-AR105722		25.71
STEERING		All	P-U-10	2-5/8	3	JD-AT38068		26.73
		All	P-U-1	2-5/8	3	JD-AT39022		13.50
MODEL 440C Skidders/Grapple Skidders								
BLADE LIFT		-282545	P-V-8	1-1/2	3	JD-AR105722		25.71
		282546-	N-N-14		3	JD-RE14082		45.35
		282546-	P-V-1	1-1/2		JD-RE14088		16.40
BOOM		All	P-V-8	2	4	JD-AR105387		29.08
		All	N-N-14		4	JD-RE16118		51.12
		All	P-V-1	2		JD-RE16119		17.14
GRAPPLE		-405023	P-V-8	2-1/4	5-1/4	JD-AR105346		39.11
		405024-	N-N-14	-	5-1/4	JD-RE14100		69.20
		405024-	P-V-1	2-1/4	-	JD-RE14208		24.51
STEERING		-400823	P-UB-10	3	3-1/4	JD-RE19216		28.08
		400824-	P-V-10	1-3/4	2-3/4	JD-AR105537		27.68
MODEL 440D, 448 Skidders/Grapple Skidders								
ARCH & BOOM		All	N-N-14		4	JD-RE16118	Model 448D only	51.12
		All	P-V-1	2		JD-RE16119	Model 448D only	17.14
BLADE LIFT		All	P-V-1	1-1/2		JD-RE14088		16.40
		All	N-N-14		3-1/2	JD-RE16076		49.55
GRAPPLE		-501505	P-V-8	2-1/4	5-1/4	JD-AR105346	Model 448D only	39.11
		501506-	N-N-14	-	5-1/4	JD-RE14100	Model 448D only	69.20
		501506-	P-V-1	2-1/4	-	JD-RE14208	Model 448D only	24.51
STEERING		All	P-V-10	1-3/4	2-3/4	JD-AR105537		27.68
MODEL 540, 540A								
FRONT BLADE		-119500, -40399	P-V-8	1-1/2	3	JD-AR105722		25.71
		119501-, 40400-	P-V-8	1-1/2	3-1/2	JD-AR105432		24.64
STEERING		All	P-U-10	3	3-1/4	JD-AT35142		42.06
		All	P-UB-1	3	3-1/4	JD-AT39023		30.04
MODEL 540B								
BLADE LIFT		-500808	P-V-8	1-1/2	3-1/2	JD-AR105432		24.64
		500809-	P-V-1	1-1/2		JD-RE14088		16.40
		500809-	N-N-14		3-1/2	JD-RE16076		49.55
BOOM		-500808	P-V-8	2	4	JD-AR105387		29.08
		500809-	N-N-14		4	JD-RE16118		51.12
		500809-	P-V-1	2		JD-RE16119		17.14
GRAPPLE		-501541	P-V-8	2-1/4	5-1/4	JD-AR105346		39.11

LGP - Low Ground Pressure LT - Long Track SLF - Super Long Front STD - Straight Dozer WT - Wide Track

Replacement Kits For

JOHN DEERE

JOHN DEERE

Skidders								
APPLICATION	CYL #	SERIAL #	CODE	ROD	BORE	KIT #	Arrangements	List \$
MODEL 540B								
GRAPPLE		501542-	N-N-14	-	5-1/4	JD-RE14100		69.20
		501542-	P-V-1	2-1/4	-	JD-RE14208		24.51
STEERING		-400571	P-UB-10	3	3-1/4	JD-RE19216		28.08
		400572-	P-V-10	1-3/4	2-3/4	JD-AR105537		27.68
MODEL 540D, 548D Grapple Skidders								
BLADE LIFT		All	P-V-1	1-1/2		JD-RE14088		16.40
		All	N-N-14		3-1/2	JD-RE16076		49.55
BOOM		All	N-N-14		4	JD-RE16118	Model 548D only	51.12
		All	P-V-1	2		JD-RE16119	Model 548D only	17.14
GRAPPLE		All	N-N-14	-	5-1/4	JD-RE14100	Model 548D only	69.20
		All	P-V-1	2-1/4	-	JD-RE14208	Model 548D only	24.51
STEERING		All	P-V-10	1-3/4	2-3/4	JD-AR105537		27.68
MODEL 640 Skidders/Grapple Skidders								
ARCH & BOOM		-500986	P-V-8	2	4	JD-AR105387		29.08
		500987-	N-N-14		4	JD-RE16118		51.12
		500987-	P-V-1	2		JD-RE16119		17.14
BLADE LIFT		-500986	P-V-8	1-3/4	4	JD-RE10223		25.79
		500987-	N-N-14		4	JD-RE16118		51.12
		500987-	P-V-1	1-3/4		JD-RE30874		18.66
BOOM (Single Function)		All	N-N-14		4	JD-RE14567	Single Function	52.56
		All	P-V-1	2		JD-RE16119	Single Function	17.14
GRAPPLE		-502132	P-V-8	2-1/2	5-1/2	JD-RE10224		50.75
		502133-	N-N-14		5-1/2	JD-RE14102		79.82
		502133-	P-V-1	2-1/2		JD-RE17345		30.04
STEERING		All	P-U-10	3-3/8	3-5/8	JD-AU42200		22.78
TILT		-503561	P-V-8	2-1/4	4-1/2	JD-AR105355		46.17
		503562-	N-N-14	-	4-1/2	JD-RE14094		53.03
		503562-	P-V-1	2-1/4	-	JD-RE14208		24.51
MODEL 640D, 648D Grapple Skidders								
ARCH & BOOM		All	N-N-14		4	JD-RE16118	Model 648D only	51.12
		All	P-V-1	2		JD-RE16119	Model 648D only	17.14
BLADE SHIFT		All	N-N-14		4	JD-RE16118		51.12
		All	P-V-1	1-3/4		JD-RE30874		18.66
BOOM (Single Function)		All	N-N-14		4	JD-RE14567	Model 648D only	52.56
		All	P-V-1	2		JD-RE16119	Model 648D only	17.14
GRAPPLE		All	N-N-14		5-1/2	JD-RE14102	Model 648D only	79.82
		All	P-V-1	2-1/2		JD-RE17345	Model 648D only	30.04
STEERING		All	N-N-14		3	JD-RE16208		44.75
		All	P-V-1	1-3/4		JD-RE16209		20.07
TILT		All	N-N-14	-	4-1/2	JD-RE14094		53.03
		All	P-V-1	2-1/4	-	JD-RE14208		24.51
MODEL 740, 740A								
ARCH & BOOM		-708051	P-V-8	2	4-1/4	JD-AR105391		31.25
		708052-	N-N-14		4-1/4	JD-RE17458	Model 740A only	54.06
		708052-	P-V-1	2		JD-RE30817	Model 740A only	20.90
GRAPPLE		-708051	P-V-8	2-3/4	6-1/4	JD-RE18744		91.30
		708052-	N-N-14		6-1/4	JD-RE14104	Model 740A only	82.17

LGP - Low Ground Pressure LT - Long Track SLF - Super Long Front STD - Straight Dozer WT - Wide Track

Replacement Kits For

JOHN DEERE

Skidders								
APPLICATION	CYL #	SERIAL #	CODE	ROD	BORE	KIT #	Arrangements	List \$
MODEL 740, 740A								
GRAPPLE		708052-	P-V-1	2-3/4		JD-RE17342	Model 740A only	40.90
LIFT		-708051	P-V-8	2	5	JD-RE18743		35.14
		708052-	N-N-14		5	JD-RE15905	Model 740A only	65.47
		708052-	P-V-1	2		JD-RE30817	Model 740A only	20.90
STEERING		All	P-UB-10	4-1/4	4.40	JD-RE19224		31.01
TILT		-708051	P-V-8	2-1/4	4-1/2	JD-AR105355		46.17
		708052-	N-N-14	-	4-1/2	JD-RE14094	Model 740A only	53.03
		708052-	P-V-1	2-1/4	-	JD-RE14208	Model 740A only	24.51
MODEL 3605 Grapple Skidders								
BOOM		10201-	P-V-8	1-3/4	3-1/2	JD-RE18754		31.52
GRAPPLE		10201-	P-V-8	1-3/4	3-1/2	JD-RE18754		31.52



KINGSEAL CO., LTD. THAILAND

46/152-153 Moo 3 Sri Saman Road
Baan Mai Pakkret, Nonthaburi Thailand 11120

Tel: +662 9617534 to 6

Fax: +662 9617540

Email: intlsales@kingseal.co.th / kingsealmail@gmail.com

Website: <http://www.kingseal.co.th>

REPLACEMENT KITS FOR JOHN DEERE

IMPORTANT - PLEASE READ

If a kit part number is unknown, the machine model number, serial number, and cylinder application will help identify the repair kit you need.

Example: Model Number **580C**
 Serial Number **5411021**
 Cylinder Application **Backhoe Swing**

If none of the above information is known, size and description of the parts needed will almost always be sufficient.

Kit Number	Code (Pg. x)	Rod X Bore Size	List Price	Kit Number	Code (Pg. x)	Rod X Bore Size	List Price
JD-905000	Track Adjuster Kit		\$ 14.16	JD-AH161781	N-N-14	100 mm Piston Kit	\$ 15.07
JD-905001	Track Adjuster Kit		36.45	JD-AH163671	N-N-14	115 mm Piston Kit	69.10
JD-905002	Track Adjuster Kit		15.35	JD-AH65915	N-OB-10	1/2 X 1	6.38
JD-905003	Track Adjuster Kit		24.33	JD-AR105272	P-U-10	1-1/2 X 3	16.11
JD-AH134477	P-UB-1	63 mm Rod Kit	66.72	JD-AR105273	P-U-5	2-1/2 X 5-1/2	70.34
JD-AH134955	N-N-10	90 mm Piston Kit	9.05	JD-AR105275	P-U-10	2-1/2 X 5-1/2	30.81
JD-AH137208	N-N-14	125 mm Piston Kit	84.51	JD-AR105280	P-U-12	2-1/2 X 6-1/2	93.31
JD-AH137209	N-N-14	140 mm Piston Kit	93.41	JD-AR105281	P-U-8	2-1/2 X 5-1/2	50.29
JD-AH137210	N-N-14	160 mm Piston Kit	72.21	JD-AR105309	P-V-8	2-3/4 X 5	47.11
JD-AH137211	N-N-14	180 mm Piston Kit	82.83	JD-AR105312	P-V-8	3-1/4 X 5-1/2	51.90
JD-AH137687	N-N-14	100 mm Piston Kit	45.59	JD-AR105313	P-V-8	3-1/4 X 5-1/2	50.49
JD-AH137789	N-N-10	2" Piston Kit	3.96	JD-AR105320	P-U-10	1-3/4 X 3-3/4	25.95
JD-AH139417	P-U-1	2-1/4 Rod Kit	25.72	JD-AR105346	P-V-8	2-1/4 X 5-1/4	39.10
JD-AH139418	I-U-8	2-1/4 X 4-1/4	33.21	JD-AR105350	USE JD-RE18759		
JD-AH142440	P-V-1	2-1/2 Rod Kit	28.56	JD-AR105351	P-V-8	2-1/4 X 4-1/2	37.49
JD-AH144593	P-UB-14	75 X 110 mm	210.17	JD-AR105352	USE JD-RE10640		
JD-AH144594	P-UB-14	85 X 120 mm	225.12	JD-AR105353	USE JD-AR105355		
JD-AH144595	P-UB-14	95 X 130 mm	187.93	JD-AR105354	USE JD-RE18757		
JD-AH148164	P-UB-1	50 mm Rod Kit	27.72	JD-AR105355	P-V-8	2-1/4 X 4-1/2	46.16
JD-AH148453	P-UB-10	95 X 130 mm	226.10	JD-AR105356	P-V-8	2-1/4 X 5-1/4	42.98
JD-AH148776	P-UB-10	75 X 110 mm	203.19	JD-AR105381	P-V-8	2 X 3-3/4	28.08
JD-AH148785	P-UB-10	85 X 120 mm	188.08	JD-AR105384	P-V-8	2 X 4-1/2	33.74
JD-AH148823	I-U-1	32 mm Rod Kit	26.74	JD-AR105387	P-V-8	2 X 4	29.09
JD-AH149194	I-UB-1	40 mm Rod Kit	32.09	JD-AR105391	P-V-8	2 X 4-1/4	31.25
JD-AH149796	P-UB-10	80 X 110 mm	241.45	JD-AR105392	P-V-8	2 X 3-1/2	25.46
JD-AH149813	P-UB-1	45 mm Rod Kit	38.45	JD-AR105393	P-V-8	2 X 4	36.76
JD-AH149814	P-UB-1	56 mm Rod Kit	35.10	JD-AR105402	P-V-8	1-3/4 X 3-1/4	25.73
JD-AH149815	P-UB-1	63 mm Rod Kit	38.52	JD-AR105403	P-V-8	1-3/4 X 2-3/4	27.80
JD-AH149842	N-N-14	80 mm Piston Kit	43.49	JD-AR105404	USE JD-RE19220		
JD-AH149843	N-N-14	90 mm Piston Kit	43.14	JD-AR105407	USE JD-RE18754		
JD-AH149844	N-N-14	100 mm Piston Kit	54.45	JD-AR105408	P-V-8	1-3/4 X 4	29.86
JD-AH149845	N-N-14	110 mm Piston Kit	68.69	JD-AR105410	USE JD-RE10223		
JD-AH149846	N-N-14	115 mm Piston Kit	76.78	JD-AR105412	P-V-8	1-3/4 X 4	40.24
JD-AH149848	N-N-14	125 mm Piston Kit	108.17	JD-AR105429	P-V-8	1-1/2 X 3-1/4	23.30
JD-AH150595	P-UB-10	65 X 95 mm	135.21	JD-AR105430	P-V-8	1-1/2 X 2-3/4	21.58
JD-AH151107	P-UB-10	70 X 105 mm	401.05	JD-AR105432	P-V-8	1-1/2 X 3-1/2	24.65
JD-AH153497	P-UB-14	40 X 63 mm	83.41	JD-AR105441	P-V-8	2-1/2 X 4-1/2	48.25
JD-AH154570	P-UB-1	75 mm Rod Kit	43.85	JD-AR105443	P-V-8	2-1/2 X 5-1/2	69.03
JD-AH155025	P-UB-10	85 X 115	203.81	JD-AR105453	P-V-8	1-1/4 X 2-1/2	23.07
JD-AH155040	P-UB-10	75 X 105	298.47	JD-AR105454	P-V-8	1-1/4 X 3	24.76
JD-AH155045	P-UB-10	80X110	221.77	JD-AR105515	P-U-5	2 X 4-1/2	60.48
JD-AH156466	P-UB-1	70 mm Rod Kit	35.41	JD-AR105537	P-V-10	1-3/4 X 2-3/4	27.68
JD-AH161590	N-N-14	63 mm Piston Kit	58.94	JD-AR105722	P-V-8	1-1/2 X 3	25.72

REPLACEMENT KITS FOR JOHN DEERE

Kit Number	Code (Pg. x)	Rod X Bore Size	List Price
JD-AR105932	P-V-8	2 X 3-1/2	\$ 25.46
JD-AR96526	P-V-8	2-1/2 X 4	45.63
JD-AR96532	P-U-8	1-3/4 X 2-1/4	15.90
JD-AR98255	P-U-5	2-5/8 X 5-1/2	72.21
JD-AR99785	P-OB-V	1-1/2 X 2-1/2	13.45
JD-AT101337	I-U-4	1-1/4 X 2-1/2	39.57
JD-AT108329	I-U-10	32 X 60 mm	28.17
JD-AT114822	P-UB-10	85 X 125 mm	100.24
JD-AT114831	P-UB-10	95 X 135 mm	120.29
JD-AT114836	P-UB-10	80 X 120 mm	92.26
JD-AT119302	P-UB-1	2-1/2" Rod Kit	21.30
JD-AT119307	N-N-10	4" Piston Kit	18.92
JD-AT120007	N-N-10	7" Piston Kit	84.40
JD-AT120008	P-UB-1	4" Rod Kit	50.38
JD-AT121499	P-UB-10	35 X 65 mm	73.52
JD-AT121500	P-UB-10	60 X 110 mm	93.46
JD-AT121501	P-UB-10	65 X 120 mm	94.91
JD-AT122564	P-UB-10	60 X 110 mm	81.81
JD-AT122580	P-UB-10	35 X 60 mm	58.32
JD-AT130600	P-UB-10	65 X 95 mm	89.32
JD-AT130601	P-UB-10	70 X 105 mm	102.95
JD-AT130602	P-UB-10	60 X 95 mm	76.29
JD-AT132411	P-UB-10	115 X 170 MM	189.28
JD-AT132412	P-UB-10	130 X 190 MM	202.73
JD-AT138119	P-UB-10	50 X 100 mm	104.57
JD-AT138137	P-UB-10	100 X 200 mm	226.94
JD-AT138138	P-UB-10	95 X 170 mm	179.48
JD-AT142582	P-U-13	2 X 3	29.08
JD-AT154867	P-UB-14	90 X 125	153.88
JD-AT154868	P-UB-14	100 X 135	112.18
JD-AT168764	P-UB-10	65 X 100 mm	104.13
JD-AT176734	P-UB-10	105X145	173.96
JD-AT176737	P-UB-10	65 X 95 mm	117.85
JD-AT176822	P-UB-10	70X105	109.73
JD-AT177556	P-UB-10	80 X 110	152.48
JD-AT180161		3-5/8 Swivel Kit	87.99
JD-AT181250	P-UB-14	85X125	90.34
JD-AT181792	P-UB-14	95 X 145 mm	102.05
JD-AT181794	P-UB-14	100 X 145 mm	120.69
JD-AT181799	P-UB-14	110 X 165 mm	146.84
JD-AT183658	P-UB-14	100X135	117.85
JD-AT192075	P-UB-10	85X120	78.52
JD-AT194335	P-U-10	80 X 115	164.35
JD-AT194457	P-UB-10	100 X 150	132.03
JD-AT200548	P-UB-10	65 X 115	128.72
JD-AT200549	P-UB-10	60 X 95	97.09
JD-AT200550	P-UB-10	55 X 85	102.36
JD-AT200573	P-UB-10	60 X 105	97.66
JD-AT200574	P-UB-10	50 X 80	91.88
JD-AT201184	P-UB-14	110 X 165 mm	220.35

Kit Number	Code (Pg. x)	Rod X Bore Size	List Price
JD-AT201185	P-UB-14	95 X 145 mm	\$ 177.79
JD-AT205923	P-UB-14	95 X 145	160.43
JD-AT217906	P-UB-14	100 X 135	195.98
JD-AT33350	USE JD-AR105402		
JD-AT33351	USE JD-AR105429		
JD-AT34930	USE JD-RE18744		
JD-AT34932	I-U-10	3-3/4 X 4	25.57
JD-AT34933	I-U-1	3-3/4 X 4	23.53
JD-AT35142	P-U-9	3 X 3-1/4	42.06
JD-AT35678	USE JD-AR105381		
JD-AT35775	USE JD-RE18759		
JD-AT35932	USE JD-AR105430		
JD-AT35934	USE JD-RE19217		
JD-AT35935	USE JD-AR105453		
JD-AT35939	USE JD-RE18739		
JD-AT35940	USE JD-RE19222		
JD-AT36404	USE JD-AR105384		
JD-AT36452	USE JD-AR105441		
JD-AT36453	USE JD-AR96526		
JD-AT36454	USE JD-AR105443		
JD-AT36829	USE JD-RE18751		
JD-AT36830	USE JD-RE18755		
JD-AT36831	USE JD-AR105355		
JD-AT36833	USE JD-RE18757		
JD-AT36835	USE JD-RE18730		
JD-AT36908	USE JD-RE18746		
JD-AT36910	USE JD-RE18738		
JD-AT36911	USE JD-RE18752		
JD-AT37322	USE JD-AR105312		
JD-AT37323	USE JD-AR105309		
JD-AT37347	USE JD-AR96532		
JD-AT38068	P-U-10	2-5/8 X 3	26.72
JD-AT38582	USE JD-RE18732		
JD-AT38583	USE JD-RE13277		
JD-AT39022	P-U-1	2-5/8 X 3	13.50
JD-AT39023	P-UB-1	3 X 3-1/4	30.04
JD-AT41687	P-U-8	1-1/4 X 2-1/4	21.59
JD-AT41688	P-U-8	1-1/2 X 2-1/4	19.99
JD-AT42765	USE JD-AR105454		
JD-AT43470	USE JD-AR105313		
JD-AT49348	USE JD-AR105356		
JD-AT52702	USE JD-RE18748		
JD-AT52703	USE JD-RE18754		
JD-AT52704	USE JD-RE18750		
JD-AT52705	USE JD-RE18736		
JD-AT52706	USE JD-RE18742		
JD-AT52707	USE JD-AR105346		
JD-AT52708	USE JD-RE18743		
JD-AT52709	USE JD-RE18747		
JD-AT52710	USE JD-AR105387		

REPLACEMENT KITS FOR JOHN DEERE

JOHN DEERE

Kit Number	Code (Pg. x)	Rod X Bore Size	List Price
JD-AT52712	USE JD-RE18737		
JD-AT55691	USE JD-AR105355		
JD-AT55692	USE JD-RE18731		
JD-AT55695	P-U-10	1-3/4 X 4	\$ 17.63
JD-AT56582	USE JD-AR105281		50.29
JD-AT78498	I-U-10	25 X 50 mm	35.62
JD-AT79722	I-U-5	1-1/2 X 3	30.13
JD-AU149810	P-U-1	25 mm Rod Kit	31.63
JD-AU41182	USE JD-AR105351		
JD-AU41735	USE JD-AR105432		
JD-AU42199	USE JD-RE19226		
JD-AU42200	USE JD-RE19227		
JD-AU43367	P-OB-10	.11/16 X 1-3/4	7.03
JD-AU43986	USE JD-AR105392		
JD-RE10223	P-V-8	1-3/4 X 4	25.79
JD-RE10224	P-V-8	2-1/2 X 5-1/2	50.75
JD-RE10640	P-V-8	2-1/4 X 4-1/2	34.58
JD-RE12912	P-V-14	1-3/4 X 3-1/2	64.21
JD-RE13277	P-V-8	2-1/2 X 5-1/2	54.69
JD-RE13745	P-V-1	2-1/2 Rod Kit	23.90
JD-RE14022	N-N-14	6-1/4 Piston Kit	86.50
JD-RE14033	N-N-14	7-1/2 Piston Kit	105.84
JD-RE14082	N-N-14	3 Piston Kit	45.35
JD-RE14088	P-V-1	1-1/2 Rod Kit	16.40
JD-RE14094	N-N-14	4-1/2 Piston Kit	53.03
JD-RE14100	N-N-14	5-1/4 Piston Kit	69.20
JD-RE14102	N-N-14	5-1/2 Piston Kit	79.83
JD-RE14104	N-N-14	6-1/4 Piston Kit	82.17
JD-RE14208	P-V-1	2-1/4 Rod Kit	24.51
JD-RE14454	P-V-1	2-1/4 Rod Kit	23.79
JD-RE14516	P-U-1	2-1/2 Rod Kit	24.66
JD-RE14517	N-N-14	3-1/2 Piston Kit	49.01
JD-RE14523	N-N-14	4-1/2 Piston Kit	53.03
JD-RE14538	P-V-1	2-1/4 Rod Kit	18.38
JD-RE14551	N-N-10	2 Piston Kit	7.40
JD-RE14552	P-U-1	1 Rod Kit	8.60
JD-RE14555	N-N-14	4 Piston Kit	49.31
JD-RE14556	P-U-1	2 Rod Kit	16.28
JD-RE14563	N-N-10	4-1/4 Piston Kit	17.73
JD-RE14567	N-N-14	4 Piston Kit	52.55
JD-RE14744	N-N-14	5 Piston Kit	65.47
JD-RE14745	P-V-1	2-1/2 Rod Kit	28.11
JD-RE14771	N-N-14	3-3/4 Piston Kit	41.58
JD-RE14772	N-N-10	2-3/4 Piston Kit	11.56
JD-RE14773	P-U-1	1-1/4 Rod Kit	15.07
JD-RE14877	N-N-14	5-1/2 Piston Kit	79.83
JD-RE14878	P-V-1	2-3/4 Rod Kit	31.41
JD-RE14879	N-N-14	6 Piston Kit	81.69
JD-RE14880	P-U-1	2-3/4 Rod Kit	28.65
JD-RE14910	N-N-14	5-1/2 Piston Kit	79.83

Kit Number	Code (Pg. x)	Rod X Bore Size	List Price
JD-RE15708	P-V-1	3-3/4 Rod Kit	\$ 67.03
JD-RE15905	N-N-14	5 Piston Kit	65.47
JD-RE15906	P-V-1	3-1/4 Rod Kit	29.13
JD-RE15907	N-N-14	5-1/2 Piston Kit	79.83
JD-RE16076	N-N-14	3-1/2 Piston Kit	49.56
JD-RE16118	N-N-14	4 Piston Kit	51.12
JD-RE16119	P-V-1	2 Rod Kit	17.14
JD-RE16208	N-N-14	3 Piston Kit	44.75
JD-RE16209	P-V-1	1-3/4 Rod Kit	20.07
JD-RE16991	P-V-1	2-3/4 Rod Kit	54.06
JD-RE16992	P-V-1	3 Rod Kit	41.09
JD-RE17097	N-N-10	3-1/2 Piston Kit	8.47
JD-RE17099	N-N-10	3-3/4 Piston Kit	10.21
JD-RE17342	P-V-1	2-3/4 Rod Kit	40.91
JD-RE17345	P-V-1	2-1/2 Rod Kit	30.04
JD-RE17351	N-N-14	5-1/2 Piston Kit	79.83
JD-RE17458	N-N-14	4-1/4 Piston Kit	54.06
JD-RE18202	N-N-10	3 Piston Kit	6.49
JD-RE18203	P-V-1	1-1/2 Rod Kit	17.78
JD-RE18708	N-N-14	3-1/2 Piston Kit	49.01
JD-RE18730	P-V-8	1-3/4 X 4	29.86
JD-RE18731	P-U-10	2-1/2 X 4-1/4	53.58
JD-RE18732	P-V-8	2 X 4	29.99
JD-RE18733	P-V-8	2 X 4	24.52
JD-RE18734	P-V-8	2-1/2 X 5-1/2	51.05
JD-RE18735	P-V-14	2-1/2 X 4	73.57
JD-RE18736	P-V-8	1-3/4 X 4	27.44
JD-RE18737	P-V-8	2 X 4-1/2	31.08
JD-RE18738	P-V-10	2 X 4	20.63
JD-RE18739	P-V-10	2-1/4 X 4-1/4	37.37
JD-RE18740	P-V-14	2-1/2 X 5-1/2	107.04
JD-RE18741	P-V-14	2 X 4	63.25
JD-RE18742	P-V-10	1-1/2 X 3-1/2	37.25
JD-RE18743	P-V-8	2 X 5	35.14
JD-RE18744	P-V-8	2-3/4 X 6-1/4	91.30
JD-RE18745	P-U-14	2-1/2 X 5-1/2	70.28
JD-RE18746	P-V-8	2-1/2 X 5-1/4	37.49
JD-RE18747	P-V-8	2-3/4 X 3-1/4	28.26
JD-RE18748	P-V-8	2 X 3-1/2	30.37
JD-RE18749	P-U-10	7/8 X 2	15.95
JD-RE18750	P-U-8	1-1/4 X 3	19.42
JD-RE18751	P-V-8	1-3/4 X 3	23.68
JD-RE18752	P-V-8	1-3/4 X 3	24.50
JD-RE18754	P-V-8	1-3/4 X 3-1/2	31.51
JD-RE18755	P-V-8	1-3/4 X 3-1/2	25.40
JD-RE18756	P-U-10	1-3/4 X 3-1/2	31.35
JD-RE18757	P-V-8	2-1/4 X 3-1/2	33.94
JD-RE18758	P-V-14	2-1/4 X 3-1/2	64.69
JD-RE18759	P-V-8	2-1/4 X 5	45.52
JD-RE18760	P-V-8	2-1/2 X 4-1/2	42.34

REPLACEMENT KITS FOR JOHN DEERE

Kit Number	Code (Pg. x)	Rod X Bore Size	List Price	Kit Number	Code (Pg. x)	Rod X Bore Size	List Price
JD-RE18762	P-V-8	3-1/4 X 6-1/4	\$ 89.26	JD-RE30874	P-V-1	1-3/4 Rod Kit	\$ 18.67
JD-RE18763	P-U-8	3-3/4 X 5-1/2	57.09	JD-RE31138	N-N-14	80 mm Piston Kit	34.37
JD-RE18764	P-V-14	2-1/4 X 4-1/2	73.83	JD-RE31139	N-N-14	100 mm Piston Kit	60.66
JD-RE18765	P-V-10, 12	2 X 3-1/2	32.34	JD-RE31140	N-N-14	115 mm Piston Kit	75.50
JD-RE19216	P-U-10	3 X 3-1/4	28.08	JD-RE31528	P-U-1	3-3/4 Rod Kit	47.27
JD-RE19217	P-V-8	1-1/2 X 2-1/2	19.48	JD-RE31716	P-UB-1	56 mm Rod Kit	45.04
JD-RE19218	P-U-8	2 X 3	28.46	JD-RE33803	N-N-14	50 mm Piston Kit	34.48
JD-RE19220	P-V-8	1-3/4 X 2-3/4	25.07	JD-RE37003	N-N-10	80 mm Piston Kit	9.72
JD-RE19222	P-V-8	1-1/2 X 2-3/4	23.17	JD-RE37004	N-N-10	70 mm Piston Kit	6.82
JD-RE19224	I-U-10	4-1/4 X 4.40	31.01	JD-RE37462	P-UB-1	70 mm Piston Kit	86.96
JD-RE19225	P-V-14	2 X 4-1/2	68.77	JD-TH102798	P-UB-10	95 X 140 mm	136.36
JD-RE19226	I-U-1	3-3/8 X 3-5/8	29.32	JD-TH102827	P-UB-10	105 X 150 mm	131.78
JD-RE19227	I-U-10	3-3/8 X 3-5/8	27.63	JD-TH102845	P-UB-10	90 X 140 mm	120.01
JD-RE20323	P-V-1	4 Rod Kit	52.87	JD-TH103324	P-UB-10	110 X 160 mm	118.26
JD-RE20329	P-V-1	3-3/4 Rod Kit	49.19	JD-TH103347	P-UB-10	110 X 160 mm	150.70
JD-RE20351	P-V-1	2-1/2 Rod Kit	26.97	JD-TH103357	P-UB-10	95 X 150 mm	132.32
JD-RE20428	N-N-14	70 mm Piston Kit	27.43	JD-TH106099	P-UB-10	60 X 100 mm	115.74
JD-RE20430	N-N-14	90 mm Piston Kit	31.04	JD-TH106853	P-UB-10	55 X 90 mm	153.84
JD-RE20433	P-UB-1	40 mm Rod Kit	36.99	JD-TH106874	P-UB-10	60 X 110 mm	77.54
JD-RE20434	P-UB-1	45 mm Rod Kit	37.21	JD-TH109339	P-UB-10	75 X 105 mm	78.99
JD-RE20595	P-U-1	50 mm Rod Kit	32.88	JD-TH109366	P-UB-10	80 X 115 mm	90.40
JD-RE20874	P-V-1	1-3/4 Rod Kit	22.64	JD-TH109390	P-UB-10	65 X 95 mm	81.99
JD-RE21202	P-UB-1	3-3/4 Rod Kit	116.71	JD-TH110035	P-UB-14	90 X 135 mm	123.98
JD-RE21395	P-UB-1	2-3/4 Rod Kit	82.17	JD-TH110064	P-UB-14	100 X 145 mm	132.87
JD-RE21401	P-UB-1	3-1/4 Rod Kit	56.34	JD-TH110661	P-UB-10	65 X 115 mm	97.13
JD-RE21873	P-UB-1	32 mm Rod Kit	31.66	JD-TH110662	P-UB-10	60 X 100 mm	60.73
JD-RE21874	N-N-14	50 mm Piston Kit	31.64	JD-TH110663	P-UB-10	55 X 90 mm	67.64
JD-RE21875	P-UB-1	25 mm Rod Kit	32.44	JD-TH111625	P-UB-14	95 X 145 mm	165.42
JD-RE25151	P-UB-1	63 mm Rod Kit	70.43	JD-TH111626	P-UB-14	100 X 145 mm	166.79
JD-RE25152	P-UB-1	80 mm Rod Kit	91.43	JD-TH111626	P-UB-14	100 X 145 mm	166.79
JD-RE28899	P-UB-1	63 mm Rod Kit	67.18	JD-TH111627	P-UB-14	110 X 165 mm	195.70
JD-RE30100	N-N-10	2-1/4 Piston Kit	4.21	JD-TH111701	P-UB-10	65 X 115 mm	111.90
JD-RE30816	N-N-14	3-1/4 Piston Kit	42.24	JD-TH111854	P-UB-14	105 X 150 mm	175.70
JD-RE30817	P-V-1	2 Rod Kit	20.90				

WEAR RINGS

Original equipment John Deere metric kits do not include the wear rings required to rebuild a cylinder. The John Deere metric kits listed in this catalog reflect this design. However, we do offer the necessary wear rings required to rebuild John Deere cylinders. The cross reference chart below lists the wear rings needed to accompany the packing kits. If you have any questions, please contact one of our sales engineers.

Kit Number	Wear Ring Part Number	QTY	List Price	Kit Number	Wear Ring Part Number	QTY	List Price	Kit Number	Wear Ring Part Number	QTY	List Price
TH102798	TH102796	2	\$ 10.45	TH111625	TH110062	2	\$ 25.18	AT176737	TH109377	2	\$ 6.21
	TH102797	2	19.91		AT159585	2	11.08		TH109378	2	14.60
TH102827	TH102825	2	10.54	TH111626	TH110062	2	25.18	AT201184	TH111273	2	16.22
	TH102826	2	21.98		TH110063	2	13.78		TH111274	2	53.34
TH102845	TH102796	2	10.45	TH111627	TH111273	2	16.22	AT201185	TH110062	2	25.18
	TH102797	2	19.27		TH111274	2	53.34		TH110063	2	13.78
TH103347	TH103345	2	11.44	TH111854	TH111845	2	26.39				
	TH103346	2	27.01		TH111846	2	14.24				
TH103357	TH102825	2	10.54	AT132412	AT132186	2	16.84				
	TH102826	2	21.98		AT132170	2	34.40				

REPLACEMENT PARTS FOR JOHN DEERE

NOTE: John Deere part numbers are used as a reference only. We do not imply that these kits are original REPLACEMENT PARTS.

WEAR RINGS

Part Number	O.D. X Width	List Price
JD-U41824	1-1/2 X 1	\$ 8.27
JD-U41825	1-3/4 X 1	3.99
JD-T48209	2 X 3/16	2.78
JD-U41823	2 X 1	4.11
JD-U42668	2-1/4 X 5/16	2.55
JD-C19240	2-1/4 X 5/8	2.68
JD-U17335	2-1/2 X 5/16	2.40
JD-U16379	2-1/2 X 1/2	2.66
JD-T40855	2-1/2 X 1	3.50
JD-W20503	2-3/4 X 5/16	2.68
JD-U17336	2-3/4 X 5/8	2.89
JD-T58314	2-3/4 X 1	3.45
JD-T36524	3 X .212	2.11
JD-H139507	3 X 3/8	2.73
JD-T40416	3 X 1/2	2.73
JD-R82412	3 X 1.192	22.25
JD-R80337	3 X 1.382	19.07
JD-T36525	3-1/4 X .212	1.76
JD-R92819	3-1/4 X 1/4	2.64
JD-A29497	3-1/4 X 3/8	2.79
JD-T47976	3-1/4 X 3/4	3.12
JD-U42862	3-1/4 X 1	4.72
JD-R70098	3-1/4 X 1-9/16	13.54
JD-R77807	3-1/2 X 3/8	2.81
JD-U16397	3-1/2 X 1/2	2.81
JD-U43261	3-1/2 X 1/2	2.81
JD-U17217	3-1/2 X 5/8	3.12
JD-U42863	3-1/2 X 5/8	3.05
JD-U42704	3-1/2 X 3/4	3.14
JD-T36526	3.605 X .212	5.31
JD-U46592	3-3/4 X 5/8	3.22
JD-T36527	3.939 X .212	2.19
JD-R77825	4 X 3/8	3.57
JD-U16387	4 X 5/8	3.35
JD-U17337	4 X 5/8	3.35
JD-U43367	4 X 5/8	3.35
JD-U43356	4 X 3/4	5.40
JD-R83321	4 X 1.378	33.43
JD-U46747	4-1/4 X 5/8	3.35
JD-U17225	4-1/2 X 5/8	3.35
JD-U42717	4-3/4 X 5-1/4	13.64
JD-U44508	5 X 5/8	3.35
JD-U42719	5-1/4 X 5/8	3.35
JD-R80526	5-1/2 X 1/2	3.01
JD-U45180	5-1/2 X 5/8	3.56

WEAR RINGS

Part Number	O.D. X Width	List Price
JD-T42985	5-1/2 X 1	\$ 4.58
JD-U42985	5-1/2 X 1	4.58
JD-R77837	6 X 1	4.65
JD-R78603	6-1/4 X 5/8	3.70
JD-U43397	6-1/4 X 1	4.72
JD-T52419	6-1/2 X 1	5.02
JD-R76907	7 X 1	6.73
JD-R77642	7-1/2 X 1	10.38
JD-R81780	46 X 20 mm	6.57
JD-R82569	50 X 5 mm	5.79
JD-R81779	51 X 22.5 mm	9.46
JD-R81975	56 X 25 mm	7.65
JD-R92310	62 X 25 mm	7.93
JD-R81774	70 X 10 mm	3.03
JD-R81777	80 X 10 mm	3.03
JD-R85230	86 X 40 mm	18.38
JD-R81776	90 X 15 mm	3.67
JD-TH109377	95 X 6 mm	6.21
JD-TH109378	95 X 8 mm	14.60
JD-TH111728	100 X 5.9 mm	28.05
JD-TH111727	100 X 6 mm	6.92
JD-TH111728	100 X 6 mm	28.05
JD-H158459	105 X 6 mm	23.85
JD-TH109323	105 X 6 mm	23.85
JD-TH109324	105 X 6 mm	65.29
JD-R81775	100 X 15 mm	10.17
JD-AT153830	110 X 5.9 mm	30.61
JD-AT153936	110 X 7.9 mm	7.39
JD-H155873	110 X 7.9 mm	7.53
JD-H163432	115 X 7.9 mm	7.53
JD-TH109356	115 X 7.9 mm	7.48
JD-R82095	115 X 15 mm	9.39
JD-H155917	120 X 7.9 mm	8.10
JD-T108046	120 X 7.9 mm	8.11
JD-T108024	125 X 7.9 mm	8.11
JD-AT154700	125 X 9.7 mm	41.21
JD-AT154735	125 X 9.9 mm	8.65
JD-R90653	125 X 20 mm	13.31
JD-H155317	130 X 7.9 mm	9.03
JD-H155318	130 X 8 mm	19.29
JD-AT154718	135 X 9.8 mm	11.89
JD-TH110034	135 X 14.8 mm	11.17
JD-TH102797	140 X 8 mm	19.91
JD-TH102796	140 X 9.5 mm	10.45
JD-R85192	140 X 20 mm	13.89

WEAR RINGS

Part Number	O.D. X Width	List Price
JD-AT161608	145 X 7.9 mm	\$31.30
JD-AT159585	145 X 9.5 mm	11.09
JD-AT161607	145 X 9.5 mm	10.45
JD-TH110062	145 X 9.7 mm	25.18
JD-TH110063	145 X 14.8 mm	13.78
JD-TH102826	150 X 8 mm	21.98
JD-TH102825	150 X 9.5 mm	10.54
JD-TH111845	150 X 9.7 mm	26.39
JD-TH111846	150 X 14.8 mm	14.24
JD-R85228	160 X 20 mm	12.62
JD-TH103345	160 X 9.5 mm	11.44
JD-TH103346	160 X 9.7 mm	27.01
JD-TH111274	165 X 9.7 mm	53.33
JD-TH111273	165 X 14.8 mm	16.22
JD-AT132291	170 X 9.5 mm	11.71
JD-AT132175	170 X 9.7 mm	33.07
JD-R85229	180 X 20 mm	13.66
JD-AT132170	190 X 9.7 mm	34.40
JD-AT132186	190 X 15 mm	16.84

WIPERS

Part Number	Rod Diameter	List Price
JD-T63053	1-3/4	\$ 9.50
JD-T60752	3	10.40
JD-T47532	5	29.73
JD-AH151380	25 mm	12.03
JD-TH100374	65 mm	29.73
JD-TH102446	80 mm	20.54
JD-TH102445	90 mm	34.10
JD-TH102411	100 mm	24.33
JD-AT131682	110 mm	38.49



REPLACEMENT PARTS FOR JOHN DEERE

NOTE: John Deere part numbers are used as a reference only. We do not imply that these kits are original REPLACEMENT PARTS.

VEE SETS

Part Number	O.D.	List Price
JD-T38194	3	\$ 13.81
JD-T38193	3-1/2	10.11
JD-R78605	3-3/4	21.66
JD-T37379	4-1/2	13.37
JD-T37380	5	25.95
JD-W37380	5	12.68
JD-U42717	5-1/4	13.64
JD-T52425	5-1/2	15.73

PISTON SEALS

Part Number	Rod Diameter	List Price
JD-RE11905	4-1/2	\$ 48.95
JD-RE11920	5-1/2	68.69
JD-RE20343	100 mm	38.53

O-RINGS

Part Number	Min. Pkg. Qty	List Price
JD-R76030	4	\$.89
JD-T46620	2	3.51

BUSHINGS

Part Number	Rod Diameter	List Price
JD-TH109372	65mm	\$ 13.52
JD-AT133645	70mm	15.26
JD-H146479	75mm	16.89
JD-TH109311	75mm	16.89
JD-T108041	80mm	19.46
JD-AT154778	85mm	21.62
JD-H146480	85mm	21.62
JD-T108019	85mm	21.62
JD-AT154779	90mm	20.85
JD-AT131420	95mm	27.63
JD-H146481	95mm	23.48
JD-T108050	95mm	23.48
JD-AT131414	100mm	32.44
JD-AT161596	105mm	27.68
JD-AT131417	110mm	52.61

BACK-UP RINGS

Part Number	Min. Pkg. Qty	List Price
JD-R78806	5	\$ 1.21
JD-R78807	2	3.77

O-RINGS 90 DUROMETER

Part Number	Min. Pkg. Qty	List Price
JD-T76938	25	\$.25
JD-T77613	34	.19
JD-T77814	34	.19
JD-T77857	34	.19
JD-T77858	25	.24
JD-T77932	29	.21
JD-T78612	20	.30
JD-T78784	20	.30



JOHNSON

Part Number	Description	List Price
JO-225VPW	2-1/4" VEE SET & WIPER	\$ 11.56
JO-325VPW	3-1/4" VEE SET & WIPER	12.39
JO-425VPW	4-1/4" VEE SET & WIPER	17.04
JO-525VPW	5-1/4" VEE SET & WIPER	17.45
JO-625NVPW	6-1/4" VEE SET & WIPER	31.65
JO-750NVPW	7-1/2" VEE SET & WIPER	45.90
JO-875NVPW	8-3/4" VEE SET & WIPER	64.64
JO-RB392	3-3/4" BORE SNAP RING	16.53
JO-RC495	4-3/4" BORE SNAP RING	19.36
JO-RD595	5-3/4" BORE SNAP RING	35.10
JO-RE724	6-7/8" BORE SNAP RING	48.87
JO-RF849	8-1/8" BORE SNAP RING	65.18

KALMAR

Part Number	Code (Pg. x)	Rod X Bore Size	List Price
KAL-920670.0003	P-U-13	32 X 63 mm	\$ 67.11
KAL-920673.0005	P-U-15	80 X 125 mm	89.04
KAL-920744.0001	P-U-13	32 X 63 mm	63.78
KAL-920744.0002	I-U-13	40 X 80 mm	88.49
KAL-920744.0003	P-U-10	60 X 80 mm	93.24
KAL-920744.0005	P-U-10	70 X 125 mm	107.01
KAL-920744.0006	P-U-15	70 X 160 mm	66.03
KAL-920744.0013	P-U-15	90 X 180 mm	76.70
KAL-921307.0001	P-U-10	50 X 100 mm	104.35

Replacement Kits For

KATO

KATO

Excavators						
APPLICATION	SERIAL #	CODE	ROD	BORE	KIT #	List \$
MODEL HD-700SEV, HD-700II, HD-720VII						
ARM	329-1719-0	P-UB-10	95 mm	135 mm	KATO-329-17190000	236.40
BOOM	329-1169-0	P-UB-10	85 mm	125 mm	KATO-329-11690000	237.20
BUCKET	329-2389-0	P-UB-10	80 mm	120 mm	KATO-329-23890000	186.98
MODEL HD-770SEII						
ARM	309-754-1	P-UB-10	90 mm	130 mm	KATO-309-75400001	207.02
BOOM	309-960-2	P-UB-10	85 mm	130 mm	KATO-309-96000002	185.87
BUCKET	309-785-1	P-UB-10	85 mm	130 mm	KATO-309-78500001	185.87
MODEL HD-800SEV, HD-880SEII						
ARM	309-755-1	P-UB-10	100 mm	140 mm	KATO-309-75500001	239.19
BOOM	309-967-2	P-UB-10	85 mm	130 mm	KATO-309-96700002	214.63
BUCKET	309-786-1	P-UB-10	85 mm	125 mm	KATO-309-78600001	182.60
MODEL HD-800VII						
ARM	329-1729-0	P-UB-10	105 mm	150 mm	KATO-329-17290000	245.97
BOOM	329-1399-0	P-UB-10	85 mm	140 mm	KATO-329-13990000	216.43
BUCKET	309-7869-10	P-UB-10	85 mm	130 mm	KATO-309-78690010	206.21
MODEL HD-900SEV						
ARM	329-172-1	P-UB-10	105 mm	150 mm	KATO-329-17200001	245.97
BOOM	309-967-11	P-UB-10	85 mm	140 mm	KATO-309-96700011	216.43
BUCKET	309-786-11	P-UB-10	85 mm	130 mm	KATO-309-78600011	206.21
MODEL HD-1250SEV						
ARM	329-175-3	P-UB-10	110 mm	160 mm	KATO-329-17500003	248.95
BOOM	329-121-2	P-UB-10	100 mm	150 mm	KATO-329-12100002	235.40
BUCKET	329-241-2	P-UB-10	100 mm	150 mm	KATO-329-24100002	235.40
MODEL HD-1250VII						
ARM	329-1759-0	P-UB-10	110 mm	160 mm	KATO-329-17590000	248.95
BOOM	329-2419-2	P-UB-10	100 mm	150 mm	KATO-329-24190002	235.40
BUCKET	329-2419-2	P-UB-10	100 mm	150 mm	KATO-329-24190002	235.40

KATO EXCAVATORS

Part Number	Code (Pg. x)	Rod X Bore Size	List Price
KATO-309-13790020	P-U-5	90 X 150 mm	\$ 161.63
KATO-309-75400001	P-UB-10	90 X 130 mm	207.02
KATO-309-75500001	P-UB-10	100 X 140 mm	239.19
KATO-309-75590000	P-UB-10	100 X 140 mm	228.79
KATO-309-78500001	P-UB-10	85 X 130 mm	185.87
KATO-309-78590010	P-UB-10	85 X 125 mm	240.30
KATO-309-78600001	P-UB-10	85 X 125 mm	182.60
KATO-309-78600011	P-UB-10	85 X 130 mm	206.21
KATO-309-78690010	P-UB-10	85 X 130 mm	206.21
KATO-309-96000002	P-UB-10	85 X 130 mm	185.87
KATO-309-96090010	P-UB-10	85 X 130 mm	249.98
KATO-309-96700002	P-UB-10	85 X 130 mm	214.63
KATO-309-96700011	P-UB-10	85 X 140 mm	216.43
KATO-329-11690000	P-UB-10	85 X 125 mm	237.20
KATO-329-12090000	P-UB-10	100 X 150 mm	249.87

Part Number	Code (Pg. x)	Rod X Bore Size	List Price
KATO-329-12100002	P-UB-10	100 X 150 mm	\$ 235.40
KATO-329-13990000	P-UB-10	85 X 140 mm	216.43
KATO-329-17190000	P-UB-10	95 X 135 mm	236.40
KATO-329-17200001	P-UB-10	105 X 150 mm	245.97
KATO-329-17290000	P-UB-10	105 X 150 mm	245.97
KATO-329-17500003	P-UB-10	110 X 160 mm	248.95
KATO-329-17590000	P-UB-10	110 X 160 mm	248.95
KATO-329-23790000	P-UB-10	65 X 95 mm	169.18
KATO-329-23890000	P-UB-10	80 X 120 mm	186.98
KATO-329-23890001	P-UB-10	80 X 120 mm	214.18
KATO-329-24100002	P-UB-10	100 X 150 mm	235.40
KATO-329-24190002	P-UB-10	100 X 150 mm	235.40
KATO-75590020	P-U-10	100 X 140 mm	265.90

Replacement Kits For

KOBELCO

KOBELCO

Excavators							
APPLICATION	CYL #	SERIAL #	CODE	ROD	BORE	KIT #	List \$
MODEL K903II							
ARM			P-UB-1	65 mm		KOB-2438U1097R100	67.20
			N-N-10		110 mm	KOB-2438U716R140	85.34
BOOM			N-N-10		125 mm	KOB-2438U1094R140	114.98
			P-UB-1	70 mm		KOB-2438U721R100	103.98
BUCKET			P-UB-1	60 mm		KOB-2438U1096R100	74.59
			N-N-10		95 mm	KOB-2438U1096R200	87.07
MODEL K904II							
ARM			P-UB-1	75 mm		KOB-2438U991R100	76.22
			N-N-10		115 mm	KOB-2438U991R200	149.32
BOOM			P-UB-1	70 mm		KOB-2438U989R100	76.86
			N-N-10		100 mm	KOB-2438U989R200	105.21
BUCKET			P-UB-1	65 mm		KOB-2438U992R100	64.38
			N-N-10		95 mm	KOB-2438U992R200	104.18
MODEL K904III							
ARM			P-UB-1	75 mm		KOB-2438U1098R100	70.92
			N-N-10		115 mm	KOB-2438U1098R200	148.36
BOOM			P-UB-1	70 mm		KOB-2438U1099R100	76.08
			N-N-10		100 mm	KOB-2438U1123R200	105.21
BUCKET			P-UB-1	65 mm		KOB-2438U1097R100	67.20
			N-N-10		95 mm	KOB-2438U1097R200	104.07
MODEL K905II							
ARM	2438U973F1		P-UB-1	80 mm		KOB-2438U973R100	89.44
	2438U973F1		N-N-10		120 mm	KOB-2438U973R200	149.07
BOOM	2438U971F2, 972FS		P-UB-1	70 mm		KOB-2438U971R100	79.17
	2438U971F2, 972FS		N-N-10		105 mm	KOB-2438U971R200	106.11
BUCKET	2438U974F1		P-UB-1	65 mm		KOB-2438U974R100	68.04
	2438U974F1		N-N-10		100 mm	KOB-2438U974R200	109.71
MODEL K907D							
ARM	2438U921F1, F2		P-UB-1	95 mm		KOB-2438U921R100	71.02
	2438U921F1, F2		N-N-10		145 mm	KOB-2438U921R110	136.48
BOOM	2438U914D1F1, D2F1		P-UB-1	85 mm		KOB-2438U914R100	75.98
	2438U914D1F1, D2F1		N-N-10		125 mm	KOB-2438U914R200	111.50
BUCKET	2438U915F1		P-UB-1	75 mm		KOB-2438U915R100	57.41
	2438U915F1		N-N-10		120 mm	KOB-2438U915R110	108.81
MODEL K907II							
ARM	2438U941F1		P-UB-1	100 mm		KOB-2438U941R100	98.97
	2438U941F1		N-N-10		145 mm	KOB-2438U941R200	187.45
BOOM	2438U996F1, 997F1		P-UB-1	85 mm		KOB-2438U996R100	87.20
	2438U996F1, 997F1		N-N-14		125 mm	KOB-2438U996R200	183.44
BUCKET	2438U995F1		P-UB-1	80 mm		KOB-2438U995R100	63.74
	2438U995F1		N-N-14		120 mm	KOB-2438U995R200	167.52
MODEL K909A							
ARM			P-UB-1	100 mm		KOB-2438U588R110	97.05
			N-N-10		150 mm	KOB-2438U588R120	137.75
BOOM			P-UB-1	90 mm		KOB-2438U587R100	89.63
			N-N-10		140 mm	KOB-2438U587R110	134.93
BUCKET			P-UB-1	90 mm		KOB-2438U568R100	89.85
			N-N-10		130 mm	KOB-2438U568R110	127.01

Replacement Kits For

KOBELCO

KOBELCO

Excavators							
APPLICATION	CYL #	SERIAL #	CODE	ROD	BORE	KIT #	List \$
MODEL K909II							
ARM	2438U953F1		P-UB-1	105 mm		KOB-2438U953R100	129.06
	2438U953F1		N-N-10		150 mm	KOB-2438U953R200	243.98
BOOM	2438U999F1, 1000F1		P-UB-1	90 mm		KOB-2438U999R100	83.74
	2438U999F1, 1000F1		N-N-10		140 mm	KOB-2438U999R200	161.28
BUCKET	2438U959F1		P-UB-1	85 mm		KOB-2438U959R100	67.72
	2438U959F1		N-N-10		130 mm	KOB-2438U959R200	151.63
MODEL K912II							
ARM	2438U1323F1		P-UB-1	110 mm		KOB-2438U1323R100	112.53
	2438U1323F1		N-N-10		160 mm	KOB-2438U1323R110	214.52
BOOM	2438U776F1		P-UB-1	95 mm		KOB-2438U776R100	103.41
	2438U776F1		N-N-10		150 mm	KOB-2438U776R110	167.33
BUCKET	2438U1324F1		P-UB-1	100 mm		KOB-2438U1324R100	79.97
	2438U1324F1		N-N-10		150 mm	KOB-2438U1324R110	103.75
MODEL K916II							
ARM	2438U1029F1		P-UB-1	130 mm		KOB-2438U1029R100	166.69
	2438U1029F1		N-N-14		180 mm	KOB-2438U1029R200	241.61
BOOM	2438U1028D1F1, D2F1		P-UB-1	110 mm		KOB-2438U1028R100	96.14
	2438U1028D1F1, D2F1		N-N-14		170 mm	KOB-2438U1028R200	238.25
BUCKET	2438U1030F1		P-UB-1	120 mm		KOB-2438U1030R100	119.88
	2438U1030F1		N-N-14		170 mm	KOB-2438U1030R200	238.25
MODEL SK60							
ARM			P-UB-1	65 mm		KOB-2438U1097R100	67.20
			N-N-10		110 mm	KOB-2438U716R140	85.34
BOOM			N-N-10		125 mm	KOB-2438U1094R140	114.98
			P-UB-1	70 mm		KOB-2438U721R100	103.98
BUCKET			P-UB-1	60 mm		KOB-2438U1096R100	74.59
			N-N-10		95 mm	KOB-2438U1096R200	87.07
MODEL SK100							
ARM			P-UB-1	75 mm		KOB-2438U1098R100	70.92
			N-N-10		115 mm	KOB-2438U1098R200	148.36
BOOM			P-UB-1	70 mm		KOB-2438U1099R100	76.08
			N-N-10		100 mm	KOB-2438U1123R200	105.21
BUCKET			P-UB-1	65 mm		KOB-2438U1097R100	67.20
			N-N-10		95 mm	KOB-2438U1097R200	104.07
MODEL SK120							
ARM	2438U1132F1	LPU1001-	P-UB-1	80 mm		KOB-2438U1132R100	83.67
	2438U1132F1	LPU1001-	N-N-10		120 mm	KOB-2438U1132R200	148.94
	2438U1132F1	LPU1001-	P-UB-10	80 mm	120 mm	KOB-2438U1132R300	232.61
BOOM LH	2438U1134F1	LPU1001-	P-UB-1	70 mm		KOB-2438U1133R100	75.05
	2438U1134F1	LPU1001-	N-N-10		105 mm	KOB-2438U1133R200	106.12
BOOM RH	2438U1134F1	LPU1001-	P-UB-10	70 mm	105 mm	KOB-2438U1133R300	172.10
	2438U1133F1	LPU1001-	P-UB-1	70 mm		KOB-2438U1133R100	75.05
BUCKET	2438U1133F1	LPU1001-	N-N-10		105 mm	KOB-2438U1133R200	106.12
	2438U1133F1	LPU1001-	P-UB-10	70 mm	105 mm	KOB-2438U1133R300	172.10
	2438U1131F1	LPU1001-	P-UB-1	65 mm		KOB-2438U1131R100	67.20
	2438U1131F1	LPU1001-	N-N-10		100 mm	KOB-2438U1131R200	108.39
	2438U1131F1	LPU1001-	P-UB-10	65 mm	100 mm	KOB-2438U1131R300	166.80

Replacement Kits For

KOBELCO

KOBELCO

Excavators							
APPLICATION	CYL #	SERIAL #	CODE	ROD	BORE	KIT #	List \$
MODEL SK120LC							
ARM	2438U1132F1	YPU1001-	P-UB-1	80 mm		KOB-2438U1132R100	83.67
	2438U1132F1	YPU1001-	N-N-10		120 mm	KOB-2438U1132R200	148.94
	2438U1132F1	YPU1001-	P-UB-10	80 mm	120 mm	KOB-2438U1132R300	232.61
BOOM LH	2438U1134F1	YPU1001-	P-UB-1	70 mm		KOB-2438U1133R100	75.05
	2438U1134F1	YPU1001-	N-N-10		105 mm	KOB-2438U1133R200	106.12
BOOM RH	2438U1134F1	YPU1001-	P-UB-10	70 mm	105 mm	KOB-2438U1133R300	172.10
	2438U1133F1	YPU1001-	P-UB-1	70 mm		KOB-2438U1133R100	75.05
BUCKET	2438U1133F1	YPU1001-	N-N-10		105 mm	KOB-2438U1133R200	106.12
	2438U1133F1	YPU1001-	P-UB-10	70 mm	105 mm	KOB-2438U1133R300	172.10
	2438U1131F1	YPU1001-	P-UB-1	65 mm		KOB-2438U1131R100	67.20
BUCKET	2438U1131F1	YPU1001-	N-N-10		100 mm	KOB-2438U1131R200	108.39
	2438U1131F1	YPU1001-	P-UB-10	65 mm	100 mm	KOB-2438U1131R300	166.80
MODEL SK150, SK150LC							
ARM	2438U1948F1	YMU1001-	N-N-10		130 mm	KOB-2438U1948R200	145.29
	2438U1948F1	YMU1001-	P-UB-1	90 mm		KOB-2438U1948R400	81.76
	2438U1948F1	YMU1001-	P-UB-10	90 mm	130 mm	KOB-2438U1948R500	227.05
BOOM LH	2438U1947F1	YMU1001-	P-UB-1	80 mm		KOB-2438U1105R400	51.29
	2438U1947F1	YMU1001-	N-N-10		120 mm	KOB-2438U1946R200	105.61
BOOM RH	2438U1947F1	YMU1001-	P-UB-10	80 mm	120 mm	KOB-2438U1946R300	156.90
	2438U1946F1	YMU1001-	P-UB-1	80 mm		KOB-2438U1105R400	51.29
BUCKET	2438U1946F1	YMU1001-	N-N-10		120 mm	KOB-2438U1946R200	105.61
	2438U1946F1	YMU1001-	P-UB-10	80 mm	120 mm	KOB-2438U1946R300	156.90
	2438U1949F1	YMU1001-	N-N-10		110 mm	KOB-2438U1949R200	130.19
BUCKET	2438U1949F1	YMU1001-	P-UB-10	75 mm		KOB-2438U1949R400	58.52
	2438U1949F1	YMU1001-	P-UB-10	75 mm	110 mm	KOB-2438U1949R500	165.63
MODEL SK150LC III							
ARM	2438U1948F1	YM000101-	N-N-10		130 mm	KOB-2438U1948R200	145.29
	2438U1948F1	YM000101-	P-UB-1	90 mm		KOB-2438U1948R400	81.76
	2438U1948F1	YM000101-	P-UB-10	90 mm	130 mm	KOB-2438U1948R500	227.05
BOOM LH	2438U1947F1	YM000101-	P-UB-1	80 mm		KOB-2438U1105R400	51.29
	2438U1947F1	YM000101-	N-N-10		120 mm	KOB-2438U1946R200	105.61
BOOM RH	2438U1947F1	YM000101-	P-UB-10	80 mm	120 mm	KOB-2438U1946R300	156.90
	2438U1946F1	YM000101-	P-UB-1	80 mm		KOB-2438U1105R400	51.29
BUCKET	2438U1946F1	YM000101-	N-N-10		120 mm	KOB-2438U1946R200	105.61
	2438U1946F1	YM000101-	P-UB-10	80 mm	120 mm	KOB-2438U1946R300	156.90
	2438U1949F1	YM000101-	N-N-10		110 mm	KOB-2438U1949R200	130.19
BUCKET	2438U1949F1	YM000101-	P-UB-10	75 mm		KOB-2438U1949R400	58.52
	2438U1949F1	YM000101-	P-UB-10	75 mm	110 mm	KOB-2438U1949R500	165.63
MODEL SK200							
ARM	2438U1104F1	YNU0001-	N-N-10		145 mm	KOB-2438U1104R200	166.36
	2438U1104F1	YNU0001-	P-UB-1	100 mm		KOB-2438U1104R400	74.22
	2438U1104F1	YNU0001-	P-UB-10	100 mm	145 mm	KOB-2438U1104R500	240.58
	2438U1108F1	YNU0001-	P-UB-1	100 mm		KOB-2438U1108R100	91.96
	2438U1108F1	YNU0001-	N-N-14		145 mm	KOB-2438U1108R200	116.53
BOOM LH	2438U1108F1	YNU0001-	P-UB-10	100 mm	145 mm	KOB-2438U1108R300	208.48
	2438U1103F1	YNU0001-	N-N-10		125 mm	KOB-2438U1102R200	112.50
	2438U1103F1	YNU0001-	P-UB-10	85 mm	125 mm	KOB-2438U1102R500	176.10
BOOM LH	2438U1103F1	YNU0001-	P-UB-1	85 mm		KOB-2438U1102R600	63.92

Replacement Kits For

KOBELCO

KOBELCO

Excavators							
APPLICATION	CYL #	SERIAL #	CODE	ROD	BORE	KIT #	List \$
MODEL SK200							
BOOM LH	2438U1107F1	YNU0001-	P-UB-1	85 mm		KOB-2438U1106R100	84.30
	2438U1107F1	YNU0001-	N-N-10		125 mm	KOB-2438U1106R200	143.53
BOOM RH	2438U1107F1	YNU0001-	P-UB-10	85 mm	125 mm	KOB-2438U1106R300	227.84
	2438U1102F1	YNU0001-	N-N-10		125 mm	KOB-2438U1102R200	112.50
	2438U1102F1	YNU0001-	P-UB-10	85 mm	125 mm	KOB-2438U1102R500	176.10
	2438U1102F1	YNU0001-	P-UB-1	85 mm		KOB-2438U1102R600	63.92
	2438U1106F1	YNU0001-	P-UB-1	85 mm		KOB-2438U1106R100	84.30
	2438U1106F1	YNU0001-	N-N-10		125 mm	KOB-2438U1106R200	143.53
BUCKET	2438U1106F1	YNU0001-	P-UB-10	85 mm	125 mm	KOB-2438U1106R300	227.84
	2438U1105F1	YNU0001-	N-N-10		120 mm	KOB-2438U1105R200	79.11
	2438U1105F1	YNU0001-	P-UB-1	80 mm		KOB-2438U1105R400	51.29
	2438U1105F1	YNU0001-	P-UB-10	80 mm	120 mm	KOB-2438U1105R500	130.40
	2438U1109F1	YNU0001-	N-N-10		120 mm	KOB-2438U1109R100	91.96
	2438U1109F1	YNU0001-	P-UB-1	80 mm		KOB-2438U1109R200	82.38
	2438U1109F1	YNU0001-	P-UB-10	80 mm	120 mm	KOB-2438U1109R300	167.18
	MODEL SK200LC						
ARM	2438U1104F1	YQU0701-	N-N-10		145 mm	KOB-2438U1104R200	166.36
	2438U1104F1	YQU0701-	P-UB-1	100 mm		KOB-2438U1104R400	74.22
	2438U1104F1	YQU0701-	P-UB-10	100 mm	145 mm	KOB-2438U1104R500	240.58
	2438U1108F1	YQU0701-	P-UB-1	100 mm		KOB-2438U1108R100	91.96
	2438U1108F1	YQU0701-	N-N-14		145 mm	KOB-2438U1108R200	116.53
	2438U1108F1	YQU0701-	P-UB-10	100 mm	145 mm	KOB-2438U1108R300	208.48
	2438U1103F1	YQU0701-	N-N-10		125 mm	KOB-2438U1102R200	112.50
	2438U1103F1	YQU0701-	P-UB-10	85 mm	125 mm	KOB-2438U1102R500	176.10
BOOM LH	2438U1103F1	YQU0701-	P-UB-1	85 mm		KOB-2438U1102R600	63.92
	2438U1107F1	YQU0701-	P-UB-1	85 mm		KOB-2438U1106R100	84.30
	2438U1107F1	YQU0701-	N-N-10		125 mm	KOB-2438U1106R200	143.53
	2438U1107F1	YQU0701-	P-UB-10	85 mm	125 mm	KOB-2438U1106R300	227.84
	2438U1102F1	YQU0701-	N-N-10		125 mm	KOB-2438U1102R200	112.50
	2438U1102F1	YQU0701-	P-UB-10	85 mm	125 mm	KOB-2438U1102R500	176.10
	2438U1102F1	YQU0701-	P-UB-1	85 mm		KOB-2438U1102R600	63.92
	2438U1106F1	YQU0701-	P-UB-1	85 mm		KOB-2438U1106R100	84.30
BOOM RH	2438U1106F1	YQU0701-	N-N-10		125 mm	KOB-2438U1106R200	143.53
	2438U1106F1	YQU0701-	P-UB-10	85 mm	125 mm	KOB-2438U1106R300	227.84
	2438U1105F1	YQU0701-	N-N-10		120 mm	KOB-2438U1105R200	79.11
	2438U1105F1	YQU0701-	P-UB-1	80 mm		KOB-2438U1105R400	51.29
	2438U1105F1	YQU0701-	P-UB-10	80 mm	120 mm	KOB-2438U1105R500	130.40
	2438U1109F1	YQU0701-	N-N-10		120 mm	KOB-2438U1109R100	91.96
	2438U1109F1	YQU0701-	P-UB-1	80 mm		KOB-2438U1109R200	82.38
	2438U1109F1	YQU0701-	P-UB-10	80 mm	120 mm	KOB-2438U1109R300	167.18
MODEL SK220 III, SK220LC III, SK220 IV, SK220LC IV							
ARM	2438U1137F1	LQU0001-, LLU0601-	P-UB-1	105 mm		KOB-2438U953R100	129.06
	2438U1137F1	LQU0001-, LLU0601-	N-N-10		150 mm	KOB-2438U953R200	243.98
BOOM LH	2438U1136F1	LQU0001-, LLU0601-	P-UB-1	90 mm		KOB-2438U999R100	83.74
	2438U1136F1	LQU0001-, LLU0601-	N-N-10		140 mm	KOB-2438U999R200	161.28

Replacement Kits For

KOBELCO

KOBELCO

Excavators							
APPLICATION	CYL #	SERIAL #	CODE	ROD	BORE	KIT #	List \$
MODEL SK220 III, SK220LC III, SK220 IV, SK220LC IV							
BOOM RH	2438U1135F1	LQU0001-, LLU0601-	P-UB-1	90 mm		KOB-2438U999R100	83.74
	2438U1135F1	LQU0001-, LLU0601-	N-N-10		140 mm	KOB-2438U999R200	161.28
BUCKET	2438U1097F1.F2	LQU0001-, LLU0601-	P-UB-1	65 mm		KOB-2438U1097R100	67.20
	2438U1097F1.F2	LQU0001-, LLU0601-	N-N-10		95 mm	KOB-2438U1097R200	104.07
	2438U1138FI	LQU0001-, LLU0601-	P-UB-1	85 mm		KOB-2438U959R100	67.72
	2438U1138FI	LQU0001-, LLU0601-	N-N-10		130 mm	KOB-2438U959R200	151.63
MODEL SK300 III							
ARM	2438U11071F1-F4	LCU0001-UP	P-UB-1	120 mm		KOB-2438U1171R100	94.61
	2438U11071F1-F4	LCU0001-UP	N-N-10		170 mm	KOB-2438U1171R200	178.41
	2438U11071F1-F4	LCU0001-UP	P-UB-10	120 mm	170 mm	KOB-2438U1171R300	273.01
BOOM LH	2438U1177F1-F4	LCU0001-UP	P-UB-1	100 mm		KOB-2438U1170R100	68.35
	2438U1177F1-F4	LCU0001-UP	P-UB-10	100 mm	150 mm	KOB-2438U1170R300	189.06
BOOM RH	2438U1170F1-F4	LCU0001-UP	P-UB-1	100 mm		KOB-2438U1170R100	68.35
	2438U1170F1-F4	LCU0001-UP	P-UB-10	100 mm	150 mm	KOB-2438U1170R300	189.06
BUCKET	2438U1172F1-F5	LCU0001-UP	N-N-10		150 mm	KOB-2438U1172R200	120.71
	2438U1172F1-F5	LCU0001-UP	P-UB-10	100 mm	150 mm	KOB-2438U1172R500	257.41
MODEL SK300 IV							
ARM	2438U11071F1-F4	LCU0101-	P-UB-1	120 mm		KOB-2438U1171R100	94.61
	2438U11071F1-F4	LCU0101-	N-N-10		170 mm	KOB-2438U1171R200	178.41
	2438U11071F1-F4	LCU0101-	P-UB-10	120 mm	170 mm	KOB-2438U1171R300	273.01
BOOM LH	2438U1177F1-F4	LCU0101-	P-UB-1	100 mm		KOB-2438U1170R100	68.35
	2438U1177F1-F4	LCU0101-	P-UB-10	100 mm	150 mm	KOB-2438U1170R300	189.06
BOOM RH	2438U1170F1-F4	LCU0101-	P-UB-1	100 mm		KOB-2438U1170R100	68.35
	2438U1170F1-F4	LCU0101-	P-UB-10	100 mm	150 mm	KOB-2438U1170R300	189.06
BUCKET	2438U1172F1-F5	LCU0101-	N-N-10		150 mm	KOB-2438U1172R200	120.71
	2438U1172F1-F5	LCU0101-	P-UB-10	100 mm	150 mm	KOB-2438U1172R500	257.41
MODEL SK300LC III							
ARM	2438U11071F1-F4	YCU0001-UP	P-UB-1	120 mm		KOB-2438U1171R100	94.61
	2438U11071F1-F4	YCU0001-UP	N-N-10		170 mm	KOB-2438U1171R200	178.41
	2438U11071F1-F4	YCU0001-UP	P-UB-10	120 mm	170 mm	KOB-2438U1171R300	273.01
BOOM LH	2438U1177F1-F4	YCU0001-UP	P-UB-1	100 mm		KOB-2438U1170R100	68.35
	2438U1177F1-F4	YCU0001-UP	P-UB-10	100 mm	150 mm	KOB-2438U1170R300	189.06
BOOM RH	2438U1170F1-F4	YCU0001-UP	P-UB-1	100 mm		KOB-2438U1170R100	68.35
	2438U1170F1-F4	YCU0001-UP	P-UB-10	100 mm	150 mm	KOB-2438U1170R300	189.06
BUCKET	2438U1172F1-F5	YCU0001-UP	N-N-10		150 mm	KOB-2438U1172R200	120.71
	2438U1172F1-F5	YCU0001-UP	P-UB-10	100 mm	150 mm	KOB-2438U1172R500	257.41
MODEL SK300LC IV							
ARM	2438U11071F1-F4	YCU0603-07 & YCU0611-	P-UB-1	120 mm		KOB-2438U1171R100	94.61
	2438U11071F1-F4	YCU0603-07 & YCU0611-	N-N-10		170 mm	KOB-2438U1171R200	178.41
	2438U11071F1-F4	YCU0603-07 & YCU0611-	P-UB-10	120 mm	170 mm	KOB-2438U1171R300	273.01
BOOM LH	2438U1177F1-F4	YCU0603-07 & YCU0611-	P-UB-1	100 mm		KOB-2438U1170R100	68.35

Replacement Kits For

KOBELCO

KOBELCO

Excavators							
APPLICATION	CYL #	SERIAL #	CODE	ROD	BORE	KIT #	List \$
MODEL SK300LC IV							
BOOM LH	2438U1177F1-F4	YCU0603-07 & YCU0611-	P-UB-10	100 mm	150 mm	KOB-2438U1170R300	189.06
BOOM RH	2438U1170F1-F4	YCU0603-07 & YCU0611-	P-UB-1	100 mm		KOB-2438U1170R100	68.35
	2438U1170F1-F4	YCU0603-07 & YCU0611-	P-UB-10	100 mm	150 mm	KOB-2438U1170R300	189.06
BUCKET	2438U1172F1-F5	YCU0603-07 & YCU0611-	N-N-10		150 mm	KOB-2438U1172R200	120.71
	2438U1172F1-F5	YCU0603-07 & YCU0611-	P-UB-10	100 mm	150 mm	KOB-2438U1172R500	257.41

REPLACEMENT KITS FOR KOBELCO

Kit Number	Code (Pg. x)	Rod X Bore Size	List Price	Kit Number	Code (Pg. x)	Rod X Bore Size	List Price
KOB-24038R42F1	N-N-14	120 mm Piston Kit	\$ 116.85	KOB-2438U1109R100	N-N-10	120 mm Piston Kit	\$ 85.54
KOB-2438U1028R100	P-UB-1	110 mm Rod Kit	96.14	KOB-2438U1109R200	P-UB-1	80 mm Rod Kit	82.38
KOB-2438U1028R200	N-N-14	170 mm Piston Kit	238.25	KOB-2438U1109R300	P-UB-10	80 X 120 mm	167.18
KOB-2438U1029R100	P-UB-1	130 mm Rod Kit	166.69	KOB-2438U1123R200	N-N-10	100 mm Piston Kit	105.21
KOB-2438U1029R200	N-N-14	180 mm Piston Kit	241.61	KOB-2438U1131R100	P-UB-1	65mm Rod Kit	67.20
KOB-2438U1030R100	P-UB-1	120 mm Rod Kit	119.88	KOB-2438U1131R200	N-N-10	100mm Piston Kit	108.39
KOB-2438U1030R200	N-N-14	170 mm Piston Kit	238.25	KOB-2438U1131R300	P-UB-10	65 X 100 mm	166.80
KOB-2438U1094R140	N-N-10	125 mm Piston Kit	114.98	KOB-2438U1132R100	P-UB-1	80 mm Rod Kit	83.67
KOB-2438U1096R100	P-UB-1	60 mm Rod Kit	74.59	KOB-2438U1132R200	N-N-10	120 mm Piston Kit	148.94
KOB-2438U1096R200	N-N-10	95 mm Piston Kit	87.07	KOB-2438U1132R300	P-UB-10	80 X 120 mm	232.61
KOB-2438U1097R100	P-UB-1	65 mm Rod Kit	67.20	KOB-2438U1133R100	P-UB-1	70 mm Rod Kit	75.05
KOB-2438U1097R200	N-N-10	95 mm Piston Kit	104.07	KOB-2438U1133R200	N-N-10	105 mm Piston Kit	106.12
KOB-2438U1098R100	P-UB-1	75 mm Rod Kit	70.92	KOB-2438U1133R300	P-UB-10	70 X 105 mm	172.10
KOB-2438U1098R200	N-N-10	115 mm Piston Kit	148.36	KOB-2438U1135R300	P-UB-10	90 X 140 mm	181.93
KOB-2438U1099R100	P-UB-1	70 mm Rod Kit	76.08	KOB-2438U1146R300	P-UB-10	75 X 110 mm	156.90
KOB-2438U1102R200	N-N-10	125 mm Piston Kit	112.50	KOB-2438U1170R100	P-UB-1	100 Rod Kit	68.35
KOB-2438U1102R500	P-UB-10	85 X 125 mm	176.42	KOB-2438U1170R300	P-UB-10	100 X 150mm	189.06
KOB-2438U1102R600	P-UB-1	85 mm Rod Kit	63.92	KOB-2438U1171R100	P-UB-1	120 Rod Kit	94.61
KOB-2438U1104R200	N-N-10	145 mm Piston Kit	166.36	KOB-2438U1171R200	N-N-10	170 mm Piston Kit	178.41
KOB-2438U1104R400	P-UB-1	100 mm Rod Kit	74.22	KOB-2438U1171R300	P-UB-10	120 X 170 mm	273.01
KOB-2438U1104R500	P-UB-10	100 X 145 mm	240.58	KOB-2438U1172R200	N-N-10	150 Piston Kit	120.71
KOB-2438U1105R200	N-N-10	120 mm Piston Kit	79.11	KOB-2438U1172R500	P-UB-10	100 X150 mm	257.41
KOB-2438U1105R400	P-UB-1	80 mm Rod Kit	51.29	KOB-2438U1173R300	P-UB-14	115 X 170 mm	308.46
KOB-2438U1105R500	P-UB-10	80 X 120 mm	130.40	KOB-2438U1174R300	P-UB-14	130 X 190 mm	439.11
KOB-2438U1106R100	P-UB-1	85 mm Rod Kit	84.30	KOB-2438U1323R100	P-UB-1	110 mm Rod Kit	112.53
KOB-2438U1106R200	N-N-10	125 mm Piston Kit	143.53	KOB-2438U1323R110	N-N-10	160 mm Piston Kit	214.52
KOB-2438U1106R300	P-UB-10	85 X 125 mm	227.84	KOB-2438U1324R100	P-UB-1	100 mm Rod Kit	79.97
KOB-2438U1108R100	P-UB-1	100 mm Rod Kit	91.96	KOB-2438U1324R110	N-N-10	150 mm Piston Kit	103.75
KOB-2438U1108R200	N-N-14	145 mm Piston Kit	176.64	KOB-2438U1343R120	P-U-1	130 mm Rod Kit	141.16
KOB-2438U1108R300	P-UB-10	100 X 145 mm	208.48	KOB-2438U1946R200	N-N-10	120 mm Piston Kit	105.61

REPLACEMENT KITS FOR KOBELCO

Kit Number	Code (Pg. x)	Rod X Bore Size	List Price
KOB-2438U1946R300	P-UB-10	80 X 120 mm	\$ 156.90
KOB-2438U1948R200	N-N-10	130 mm Piston Kit	145.29
KOB-2438U1948R400	P-UB-1	90 mm Rod Kit	81.76
KOB-2438U1948R500	P-UB-10	90 X 130 mm	227.05
KOB-2438U1949R200	N-N-10	110 mm Piston Kit	130.19
KOB-2438U1949R400	P-UB-10	75 mm Rod Kit	58.52
KOB-2438U1949R500	P-UB-10	75 X 110 mm	165.63
KOB-2438U553R100	P-U-1	75 mm Rod Kit	79.27
KOB-2438U568R100	P-UB-10	90 mm Rod Kit	89.85
KOB-2438U568R110	P-UB-10	130 mm Piston Kit	127.01
KOB-2438U587R100	P-UB-1	90 mm Rod Kit	89.63
KOB-2438U587R110	N-N-10	140 mm Piston Kit	134.93
KOB-2438U588R110	P-UB-10	100 mm Rod Kit	97.05
KOB-2438U588R120	N-N-10	150 mm Piston Kit	137.75
KOB-2438U716R140	N-N-10	110 mm Piston Kit	85.34
KOB-2438U721R100	P-UB-1	70 mm Rod Kit	103.98
KOB-2438U776R100	P-UB-1	95 mm Rod Kit	103.41
KOB-2438U776R110	N-N-10	150 mm Piston Kit	167.33
KOB-2438U914R100	P-UB-1	85 mm Rod Kit	75.98
KOB-2438U914R200	N-N-10	125 mm Piston Kit	111.50
KOB-2438U915R100	P-UB-1	75 mm Rod Kit	57.41
KOB-2438U915R110	N-N-10	120 mm Piston Kit	108.81
KOB-2438U921R100	P-UB-1	95 mm Rod Kit	71.02
KOB-2438U921R110	N-N-10	145 mm Piston Kit	136.48
KOB-2438U941R100	P-UB-1	100 mm Rod Kit	98.97
KOB-2438U941R200	N-N-14	145 mm Piston Kit	187.45

Kit Number	Code (Pg. x)	Rod X Bore Size	List Price
KOB-2438U953R100	P-UB-1	105 mm Rod Kit	\$ 129.06
KOB-2438U953R200	N-N-10	150 mm Piston Kit	243.98
KOB-2438U959R100	P-UB-1	85 mm Rod Kit	67.72
KOB-2438U959R200	N-N-10	130 mm Piston Kit	151.63
KOB-2438U971R100	P-UB-1	70 mm Rod Kit	79.17
KOB-2438U971R200	N-N-10	105 mm Piston Kit	106.11
KOB-2438U973R100	P-UB-1	80 mm Rod Kit	89.44
KOB-2438U973R200	N-N-10	120 mm Piston Kit	149.07
KOB-2438U974R100	P-UB-10	65 mm Rod Kit	68.04
KOB-2438U974R200	N-N-10	100 mm Piston Kit	109.71
KOB-2438U985R300	N-N-14	180 mm Piston Kit	192.66
KOB-2438U989R100	P-UB-1	70 mm Rod Kit	76.86
KOB-2438U989R200	N-N-10	100 mm Piston Kit	105.21
KOB-2438U991R100	P-UB-1	75 mm Rod Kit	76.22
KOB-2438U991R200	N-N-10	115 mm Piston Kit	149.32
KOB-2438U992R100	P-UB-1	65 mm Rod Kit	64.38
KOB-2438U992R200	N-N-10	95 mm Piston Kit	104.18
KOB-2438U995R100	P-UB-1	80 mm Rod Kit	63.74
KOB-2438U995R200	N-N-14	120 mm Piston Kit	167.52
KOB-2438U996R100	P-UB-1	85 mm Rod Kit	87.20
KOB-2438U996R200	N-N-14	125 mm Piston Kit	183.44
KOB-2438U999R100	P-UB-1	90 mm Rod Kit	83.74
KOB-2438U999R200	N-N-10	140 mm Piston Kit	161.28
KOB-2445Z-921F1	N-N-10	100 mm Piston Kit	63.60
KOB-2445Z-922F1	P-UB-1	50 mm Rod Kit	56.26



KINGSEAL CO., LTD. THAILAND

46/152-153 Moo 3 Sri Saman Road
Baan Mai Pakkret, Nonthaburi Thailand 11120

Tel: +662 9617534 to 6

Fax: +662 9617540

Email: intlsales@kingseal.co.th / kingsealmail@gmail.com

Website: <http://www.kingseal.co.th>

REPLACEMENT PARTS FOR KOBELCO

NOTE: Kobelco part numbers are used as a reference only. We do not imply that these kits are original REPLACEMENT PARTS.

WIPERS

Part Number	Rod Dia.	List Price
KOB-2438U908S27	65 mm	\$ 21.69
KOB-2438U922S25	70 mm	23.27
KOB-2438U922S31	70 mm	23.27
KOB-2438U915S26	75 mm	25.03
KOB-2438U928S24	80 mm	29.50
KOB-2438U928S33	80 mm	29.50
KOB-2438U914D1S22	85 mm	33.49
KOB-2438U914S28	85 mm	33.49
KOB-2438U999S10	90 mm	36.21
KOB-2438U776S9	95 mm	37.03
KOB-2438U921S34	95 mm	37.03
KOB-2438U1324S9	100 mm	38.01
KOB-2438U588S38	100 mm	38.01
KOB-2438U953S10	105 mm	36.73
KOB-2438U1323S9	110 mm	38.93
KOB-2438U510S29	110 mm	38.93
KOB-2438U1343S28	130 mm	46.64

U-SEALS

Part Number	Rod Dia.	List Price
KOB-2438U561S11	70 mm	\$ 13.80
KOB-2438U309S35	75 mm	15.21
KOB-2418U130D34	80 mm	16.92
KOB-2438U914D1S21	85 mm	18.39
KOB-2438U959S7	85 mm	21.53
KOB-2438U999S7	90 mm	19.36
KOB-2438U720S21	95 mm	20.49
KOB-2438U776S7	95 mm	20.66
KOB-2438U1324S7	100 mm	22.41
KOB-24838U17-18	100 mm	28.61
KOB-2438U953S7	105 mm	27.27
KOB-2418U130D23	110 mm	28.46
KOB-2438U1323S7	110 mm	29.88
KOB-2438U352S10	120 mm	31.84
KOB-2418U130D29	130 mm	28.27

PISTON SEALS

Part Number	Bore Dia.	List Price
KOB-2438U995S8	120 mm	\$ 41.91
KOB-2438U980S8	125 mm	46.59
KOB-2438U982S6	145 mm	57.42
KOB-2438U984S10	170 mm	79.82
KOB-2438U985S8	180 mm	73.83

2 PIECE PISTON SEALS

Part Number	Bore Dia.	List Price
KOB-2438U504S7	100 mm	\$ 28.52
KOB-2438U807S4	105 mm	28.05
KOB-2438U695S6	120 mm	31.35
KOB-2438U1382S15	130 mm	32.44
KOB-2438U999S16	140 mm	37.04
KOB-2438U706S6	145 mm	38.04
KOB-2438U1324S15	150 mm	39.83
KOB-2438U776S15	150 mm	39.83
KOB-2438U1323S15	160 mm	43.47

BUFFER SEALS

Part Number	Rod Dia.	List Price
KOB-R45P0050D6	65 mm	\$ 18.61
KOB-R45P0050D1	70 mm	21.62
KOB-R45P0050D2	75 mm	23.07
KOB-R45P0050D9	80 mm	24.87
KOB-2438U278S25	85 mm	28.54
KOB-2438U959S6	85 mm	28.54
KOB-2438U999S6	90 mm	24.02
KOB-2438U720S19	95 mm	29.79
KOB-2438U776S6	95 mm	29.79
KOB-2438U1324S6	100 mm	30.92
KOB-R45P0050D11	100 mm	30.92
KOB-2438U953S6	105 mm	32.20
KOB-2438U1323S6	110 mm	33.61
KOB-R45P0050D12	110 mm	33.61
KOB-R45P0050D4	120 mm	33.68
KOB-R45P0050D13	130 mm	34.32

ROD BUSHING

Part Number	Rod Dia.	List Price
KOB-2438U1324S4	100 mm	\$ 56.22



REPLACEMENT PARTS FOR KOBELCO

NOTE: Kobelco part numbers are used as a reference only. We do not imply that these kits are original REPLACEMENT PARTS.

O-RINGS

Part Number	Min. Pkg Qty	List Price
KOB-2429U71S19	4	\$ 1.06
KOB-2438U1323S10	2	5.11
KOB-2438U1324S10	2	4.22
KOB-2438U776S10	2	4.22
KOB-2438U914D1S14	4	1.06
KOB-45Z91D125	5	1.20
KOB-ZD11P11000	3	3.86
KOB-ZD12G06500	5	1.07
KOB-ZD12G07500	5	1.20
KOB-ZD12G08000	5	1.25
KOB-ZD12G09000	4	1.55
KOB-ZD12G09500	4	1.65
KOB-ZD12G10000	4	1.76
KOB-ZD12G10500	3	1.86
KOB-ZD12G11000	3	3.86
KOB-ZD12G11500	3	2.14
KOB-ZD12G12000	3	2.22
KOB-ZD12G16000	2	4.18
KOB-ZD12G17000	2	4.58
KOB-ZD12P09000	3	2.82

O-RINGS

Part Number	Min. Pkg Qty	List Price
KOB-ZD12P09500	3	\$ 2.92
KOB-ZD12P11000	3	3.86
KOB-ZD12P11500	2	3.93
KOB-ZD12P12000	2	4.01
KOB-ZD12P13000	2	4.09
KOB-ZD12P13500	2	4.16
KOB-ZD12P14000	2	4.22

BACK-UP RINGS

Part Number	Min. Pkg Qty	List Price
KOB-2429U71S18	1	\$ 12.20
KOB-2438U1029S20	1	7.08
KOB-2438U1323S11	1	6.69
KOB-2438U1323S8	1	16.43
KOB-2438U1324S11	1	7.80
KOB-2438U1324S8	1	14.33
KOB-2438U738S26	1	4.44
KOB-2438U776S11	1	7.80
KOB-2438U776S8	1	7.75

BACK-UP RINGS

Part Number	Min. Pkg Qty	List Price
KOB-2438U897S13	1	\$ 6.47
KOB-2438U914S27	1	7.11
KOB-2438U915S13	1	12.20
KOB-2438U921S16	1	7.67
KOB-2438U921S33	1	7.67
KOB-2438U922S17	1	6.42
KOB-2438U953S8	1	14.84
KOB-2438U959S12	1	7.18
KOB-2438U959S8	1	5.57
KOB-2438U999S12	1	5.19
KOB-2438U999S8	1	7.75
KOB-2445R216D22	1	7.03
KOB-ZD75G07500	1	4.55
KOB-ZD75G08000	1	4.61
KOB-ZD75G09000	1	4.66
KOB-ZD75G09500	1	4.66
KOB-ZD75G10000	1	4.78
KOB-ZD75G10500	1	4.89
KOB-ZD75G11500	1	5.00
KOB-ZD85P11000	1	12.20

KOEHRING

Kit Number	Code (Pg. x)	Rod X Bore Size	List Price
KR-203088	O-RING KIT		\$ 3.87
KR-204650	P-U-10	3-1/4 X 4-3/4	37.93
KR-207889	I-U-10	5-1/2 X 11	125.32
KR-24589	I-U-10	3-1/2 X 6-1/2	31.91
KR-28054	P-U-10	2-1/2 X 4	28.57
KR-29760	I-U-10	2-1/2 X 4	11.86
KR-603E2503	I-U-12	1-3/4 X 3-1/2	37.52
KR-6620BC	P-U-14	80 X 120 mm	121.19
KR-7004208	P-U-9	2 X 4	64.55
KR-8030236	P-U-10	1 X 2-3/4	10.55
KR-8032707	I-U-10	2 X 5	35.53
KR-8032718	I-U-10	3 X 5-1/2	29.11
KR-8032957	O-RING KIT		6.03
KR-8033253	I-U-10	1-1/8 X 2-1/4	19.54
KR-8033489	I-U-13	1-1/2 X 2-1/4	19.54
KR-8205601	I-V-1	3-1/2" ROD	16.88

Kit Number	Code (Pg. x)	Rod X Bore Size	List Price
KR-8205602	P-V-9	3 X 4	\$ 36.82
KR-8205603	I-V-9	2 X 4	29.23
KR-8205604	I-V-9	1-1/2 X 4	26.88
KR-8205629	P-OB-10	7/8 X 2-1/4	12.16
KR-8205635	I-U-9	2 X 4	25.03
KR-8205639	I-U-5	2-1/2 X 6	56.76
KR-8205640	I-U-5	1-3/4 X 4-1/4	35.33
KR-8205641	I-U-5	2 X 5	42.34
KR-8205642	I-U-9	3 X 4	30.79
KR-8205642-1	I-U-10	3 X 4-1/2	21.96
KR-8205643	I-U-5	1-1/2 X 3	25.24
KR-8205646	I-U-10	3 X 4-1/2	22.16
KR-8205648	I-U-10	1-1/4 X 2-1/2	12.05
KR-8205668	P-U-10	3 X 5-1/2	38.48
KR-A24589	I-U-10	3-1/2 X 6-1/2	31.91

REPLACEMENT SEAL KITS FOR KOMATSU EQUIPMENT*

KOMATSU

Replacement Seal Kits By Machine Type

Table of Contents

Machine Type		Page
Crawler Dozers	D20A-5, D20P-5, D20PL-5, D20Q-5, D20S-5, D21P-5, D21PL-5, D21Q-5, D21S-5, D31A-17, D31E-18, D31P-17, D31P-17A, D31P-17B, D31P-18, D31PL-18, D31PLL-18, D31P-18A, D31PL-17, D31PLL-17, D31Q-17, D31Q-18, D31S-17, D31S-18, D37E-1, D37P-1, D37E-2, D37P-2, D40A-3, D41A-3, D40F-3, D40P-3, D40PL-3, D40PLL-3, D41P-3, D41E-3, D41Q-3, D41S-3, D50A-16, D53A-16, D50A-17, D53A-17, D50P-16, D50P-17, D50PL-17, D53P-17, D53P-16, D53S-17, D57S-1, D58E-1, D58P-1, D60A-7, D60E-7, D65A-7, D65E-7, D60A-8, D65A-8, D60E-8, D60P-7, D60PL-7, D65P-7, D60P-8, D60PL-8, D60S-7, D65S-7, D60S-8, D65S-8, D63E-1, D65A-6, D65E-8, D65P-6, D65P-7, D65P-8, D66S-1, D68E-1, D68P-1, D75A-1, D75S-3, D75S-5, D80A-18, D80E-18, D83E-1, D83P-1, D85A-18, D85A-21, D85E-21, D85E-18, D85P-21, D95S-2, D135A-1, D135A-2, D155A-1, D155A-2, D375A-1, D375A-2, D475A-1, D475A-2	406 - 413
Dump Trucks	HD325-3, HD325-5, HD465-3, HD785-3, HD1200M-1	414
Excavators - Tracked	PC20-5, PC30-5, PC30-6, PC40-5, PC40-6, PC50UU-1, PC60-5, PC60L-5, PC60U-5, PC75UU-1, PC80-3, PC80LC-3, PC90-1, PC100-1, PC100-2, PC100-3, PC100-5, PC100L-3, PC100L-5, PC100U-3, PC120-3, PC120-5, PC150-3, PC150-5, PC150LC-3, PC200-1, PC200-2, PC200-3, PC200LC-3, PC200-5, PC200LC-5, PC210-3, PC210LC-3, PC210-6, PC210LC-6, PC220, PC220LC, PC220-2, PC220LC-2, PC220-3, PC220LC-3, PC220-5, PC220LC-5, PC280LC-3, PC300-3, PC300LC-3, PC300-5, C300LC-5, PC360LC-3, PC400-3, PC400LC-3, PC400-5, PC400LC-5, PC650-1, PC650-3, PC1000-1, PC1000SE-1	414 - 419
Excavators - Wheeled	PW20-1, PW30-1, PW60-3, PW100-1, PW100-3, PW100N-3, PW150-1, PW210-1	419 - 420
Motor Graders	GD200A-1, GD300A-1, GD405A-1, GD500R-2, GD505A-2, GD505R-2, GD510R-1, GD511A-1, GD513A-1, GD513R-1, GD515A-1, GD521A-1, GD521R-1, GD523A-1, GD523R-1, GD525A-1, GD600R-3, GD605A-3, GD611A-1, GD611R-1, GD613A-1, GD613R-1, GD615A-1, GD621A-1, GD621R-1, GD623A-1, GD623R-1, GD663A-1, GD625A-1, GD705A-3, GD705A-4, GD825A-1	421 - 423
Wheel Loaders	WA30-1, WA30-2, WA70-1, WA100-1, WA120-1, WA150-1, WA180-1, WA200-1, WA250-1, WA300-1, WA320-1, WA350-1, WA380-1, WA400-1, WA420-1, WA450-1, WA470-1, WA500-1, WA600-1, WA800-1, WA800-2	423 - 426
Alpha-Numeric Kit Listing		427 - 429
Komatsu Individual Parts		429 - 434



All manufacturer's names, part numbers and descriptions are used for reference purposes only. We do not imply that any part shown is the product of these manufacturers. We also do not imply that the list price shown is exactly that of the manufacturer.

Replacement Kits For

KOMATSU

KOMATSU

Crawler Dozers							
APPLICATION	CYL #	SERIAL #	CODE	ROD	BORE	KIT #	List \$
MODEL D20A-5							
TRIMMING	101-63-79300	45001-	P-U-14	35 mm	70 mm	KOM-707-98-12440	51.51
	101-63-79400	45001-	P-U-14	35 mm	70 mm	KOM-707-98-12440	51.51
MODEL D20P-5							
TILT	101-63-52100	45003-53245	P-U-14	40 mm	80 mm	KOM-707-99-22010	72.78
	101-63-52101	53246-	P-U-14	40 mm	80 mm	KOM-707-99-22010	72.78
TRIMMING	101-63-79300	45003-	P-U-14	35 mm	70 mm	KOM-707-98-12440	51.51
	101-63-79400	45003-	P-U-14	35 mm	70 mm	KOM-707-98-12440	51.51
MODEL D20PL-5							
TILT	101-63-52100	45001-50601	P-U-14	40 mm	80 mm	KOM-707-99-22010	72.78
	101-63-52101	50602-	P-U-14	40 mm	80 mm	KOM-707-99-22010	72.78
MODEL D20Q-5							
LIFT	103-63-22100	45368-51505	P-U-5	45 mm	80 mm	KOM-707-98-24050	74.57
	103-63-22101	51506-	P-U-5	45 mm	80 mm	KOM-707-98-24050	74.57
	103-63-22200	45368-51505	P-U-5	45 mm	80 mm	KOM-707-98-24050	74.57
	103-63-22201	51506-	P-U-5	45 mm	80 mm	KOM-707-98-24050	74.57
MODEL D20S-5							
LIFT	103-63-22100	45001-51497	P-U-5	45 mm	80 mm	KOM-707-98-24050	74.57
	103-63-22101	51498-	P-U-5	45 mm	80 mm	KOM-707-98-24050	74.57
	103-63-22200	45001-51497	P-U-5	45 mm	80 mm	KOM-707-98-24050	74.57
	103-63-22201	51498-	P-U-5	45 mm	80 mm	KOM-707-98-24050	74.57
MODEL D21P-5							
TILT	101-63-52100	45007-53306	P-U-14	40 mm	80 mm	KOM-707-99-22010	72.78
	101-63-52101	53307-	P-U-14	40 mm	80 mm	KOM-707-99-22010	72.78
MODEL D21PL-5							
TILT	101-63-52100	45013-50606	P-U-14	40 mm	80 mm	KOM-707-99-22010	72.78
	101-63-52101	50607-	P-U-14	40 mm	80 mm	KOM-707-99-22010	72.78
MODEL D21Q-5							
LIFT	103-63-22100	45094-51497	P-U-5	45 mm	80 mm	KOM-707-98-24050	74.57
	103-63-22101	51493-	P-U-5	45 mm	80 mm	KOM-707-98-24050	74.57
	103-63-22200	45094-51497	P-U-5	45 mm	80 mm	KOM-707-98-24050	74.57
	103-63-22201	51493-	P-U-5	45 mm	80 mm	KOM-707-98-24050	74.57
MODEL D21S-5							
LIFT	103-63-22100	45003-51526	P-U-5	45 mm	80 mm	KOM-707-98-24050	74.57
	103-63-22101	51527-	P-U-5	45 mm	80 mm	KOM-707-98-24050	74.57
	103-63-22200	45003-51526	P-U-5	45 mm	80 mm	KOM-707-98-24050	74.57
	103-63-22201	51527-	P-U-5	45 mm	80 mm	KOM-707-98-24050	74.57
MODEL D31A-17							
PAT ANGLE	114-63-55500	32001-	P-U-14	40 mm	90 mm	KOM-114-63-05030	64.55
PAT LIFT	114-63-12500	32001-	P-U-14	40 mm	90 mm	KOM-114-63-05030	64.55
	114-63-12600	32001-	P-U-14	40 mm	90 mm	KOM-114-63-05030	64.55
PAT TILT	114-63-54501	32001-	P-U-14	40 mm	90 mm	KOM-114-63-05030	64.55
RIPPER	113-63-42501	32001-	P-U-14	40 mm	90 mm	KOM-707-98-22500	69.13
TRIMMING	114-63-79500	32001-	P-U-14	40 mm	90 mm	KOM-707-98-22500	69.13
	114-63-79600	32001-	P-U-14	40 mm	90 mm	KOM-707-98-22500	69.13
TRIMMING LIFT	114-63-69500	32001-	P-U-14	40 mm	90 mm	KOM-707-98-22500	69.13
	114-63-69600	32001-	P-U-14	40 mm	90 mm	KOM-707-98-22500	69.13
MODEL D31E-18							
3-POINT HITCH	113-63-49500	40001-	P-U-14	45 mm	80 mm	KOM-707-98-24150	75.68

Replacement Kits For

KOMATSU



Crawler Dozers							
APPLICATION	CYL #	SERIAL #	CODE	ROD	BORE	KIT #	List \$
MODEL D31E-18							
3-POINT HITCH	113-63-49600	40001-	P-U-14	45 mm	80 mm	KOM-707-98-24150	75.68
PAT ANGLE	114-63-02031	40001-	P-U-10	40 mm	90 mm	KOM-707-98-22420	67.66
PAT LIFT	114-63-02011	40001-	P-U-10	40 mm	90 mm	KOM-707-98-22420	67.66
PAT TILT	114-63-02041	40001-	P-U-10	40 mm	90 mm	KOM-707-98-22420	67.66
RIPPER	113-63-42501	40001-	P-U-14	40 mm	90 mm	KOM-707-98-22500	69.13
TRIMMING	114-63-02050	40001-	P-U-10	40 mm	90 mm	KOM-707-98-22410	67.66
TRIMMING LIFT	114-63-02070	40001-	P-U-10	40 mm	90 mm	KOM-707-98-22410	67.66
MODEL D31P-17							
LIFT	11G-63-13500	32001-	P-U-14	40 mm	90 mm	KOM-114-63-05030	64.55
	11G-63-13600	32001-	P-U-14	40 mm	90 mm	KOM-114-63-05030	64.55
TILT	11G-63-52500	32001-	P-U-14	40 mm	90 mm	KOM-707-98-22500	69.13
TRIMMING	114-63-79500	32001-	P-U-14	40 mm	90 mm	KOM-707-98-22500	69.13
	114-63-79600	32001-	P-U-14	40 mm	90 mm	KOM-707-98-22500	69.13
TRIMMING LIFT	114-63-69500	32001-	P-U-14	40 mm	90 mm	KOM-707-98-22500	69.13
	114-63-69600	32001-	P-U-14	40 mm	90 mm	KOM-707-98-22500	69.13
MODEL D31P-17A, D31P-17B							
3-POINT HITCH	113-63-49500	32001-	P-U-14	45 mm	80 mm	KOM-707-98-24150	75.68
	113-63-49600	32001-	P-U-14	45 mm	80 mm	KOM-707-98-24150	75.68
PAT ANGLE	114-63-55500	32001-	P-U-14	40 mm	90 mm	KOM-114-63-05030	64.55
PAT LIFT	114-63-12500	32001-	P-U-14	40 mm	90 mm	KOM-114-63-05030	64.55
	114-63-12600	32001-	P-U-14	40 mm	90 mm	KOM-114-63-05030	64.55
PAT TILT	114-63-54501	32001-	P-U-14	40 mm	90 mm	KOM-114-63-05030	64.55
MODEL D31P-18, D31PL-18, D31PLL-18							
3-POINT HITCH	113-63-49500	40001-	P-U-14	45 mm	80 mm	KOM-707-98-24150	75.68
	113-63-49600	40001-	P-U-14	45 mm	80 mm	KOM-707-98-24150	75.68
TILT	11G-63-02051	40001-	P-U-10	40 mm	90 mm	KOM-707-98-22410	67.66
MODEL D31P-18A							
3-POINT HITCH	113-63-49500	40001-	P-U-14	45 mm	80 mm	KOM-707-98-24150	75.68
	113-63-49600	40001-	P-U-14	45 mm	80 mm	KOM-707-98-24150	75.68
PAT ANGLE	114-63-02031	40001-	P-U-10	40 mm	90 mm	KOM-707-98-22410	67.66
PAT LIFT	114-63-02011	40001-	P-U-10	40 mm	90 mm	KOM-707-98-22410	67.66
PAT TILT	114-63-02041	40001-	P-U-10	40 mm	90 mm	KOM-707-98-22410	67.66
MODEL D31PL-17, D31PLL-17							
LIFT	11G-63-13500	32001-	P-U-14	40 mm	90 mm	KOM-114-63-05030	64.55
	11G-63-13600	32001-	P-U-14	40 mm	90 mm	KOM-114-63-05030	64.55
TILT	11G-63-52500	32001-	P-U-14	40 mm	90 mm	KOM-707-98-22500	69.13
MODEL D31Q-17							
DUMP	113-63-32500	32001-	P-U-14	45 mm	80 mm	KOM-707-98-24150	75.68
	113-63-32600	32001-	P-U-14	45 mm	80 mm	KOM-707-98-24150	75.68
LIFT	113-63-22500	32001-	P-U-14	50 mm	100 mm	KOM-707-99-32010	96.77
	113-63-22600	32001-	P-U-14	50 mm	100 mm	KOM-707-99-32010	96.77
MODEL D31Q-18							
3-POINT HITCH	113-63-49500	40001-	P-U-14	45 mm	80 mm	KOM-707-98-24150	75.68
	113-63-49600	40001-	P-U-14	45 mm	80 mm	KOM-707-98-24150	75.68
LIFT	113-63-02011	40001-	P-U-14	50 mm	100 mm	KOM-707-98-32050	90.78
	113-63-02021	40001-	P-U-14	50 mm	100 mm	KOM-707-98-32050	90.78
MODEL D31S-17							
DUMP	113-63-32500	32001-	P-U-14	45 mm	80 mm	KOM-707-98-24150	75.68

Replacement Kits For

KOMATSU

KOMATSU

Crawler Dozers							
APPLICATION	CYL #	SERIAL #	CODE	ROD	BORE	KIT #	List \$
MODEL D31S-17							
DUMP	113-63-32600	32001-	P-U-14	45 mm	80 mm	KOM-707-98-24150	75.68
LIFT	113-63-22500	32001-	P-U-14	50 mm	100 mm	KOM-707-99-32010	96.77
	113-63-22600	32001-	P-U-14	50 mm	100 mm	KOM-707-99-32010	96.77
MULTI-PURPOSE BUCKET CLAM	113-63-59500	32001-	P-U-14	45 mm	80 mm	KOM-707-98-24150	75.68
MODEL D31S-18							
3-POINT HITCH	113-63-49500	40001-	P-U-14	45 mm	80 mm	KOM-707-98-24150	75.68
	113-63-49600	40001-	P-U-14	45 mm	80 mm	KOM-707-98-24150	75.68
LIFT	113-63-02011	40001-	P-U-14	50 mm	100 mm	KOM-707-98-32050	90.78
	113-63-02021	40001-	P-U-14	50 mm	100 mm	KOM-707-98-32050	90.78
MULTI-PURPOSE BUCKET CLAM	113-63-59500	40001-	P-U-14	45 mm	80 mm	KOM-707-98-24150	75.68
RIPPER	113-63-42501	40001-	P-U-14	40 mm	90 mm	KOM-707-98-22500	69.13
MODEL D37E-1, D37P-1							
3-POINT HITCH	113-63-49500	1001-	P-U-14	45 mm	80 mm	KOM-707-98-24150	75.68
	113-63-49600	1001-	P-U-14	45 mm	80 mm	KOM-707-98-24150	75.68
ANGLE LIFT	11G-63-13500	1001-	P-U-14	40 mm	90 mm	KOM-114-63-05030	64.55
	11G-63-13600	1001-	P-U-14	40 mm	90 mm	KOM-114-63-05030	64.55
PAT ANGLE	114-63-55500	1001-	P-U-14	40 mm	90 mm	KOM-114-63-05030	64.55
PAT LIFT	114-63-12500	1001-	P-U-14	40 mm	90 mm	KOM-114-63-05030	64.55
	114-63-12600	1001-	P-U-14	40 mm	90 mm	KOM-114-63-05030	64.55
PAT TILT	114-63-54501	1001-	P-U-14	40 mm	90 mm	KOM-114-63-05030	64.55
RIPPER	113-63-42501	1001-	P-U-14	40 mm	90 mm	KOM-707-98-22500	69.13
MODEL D37E-2, D37P-2							
3-POINT HITCH	113-63-49500	2001-	P-U-14	45 mm	80 mm	KOM-707-98-24150	75.68
	113-63-49600	2001-	P-U-14	45 mm	80 mm	KOM-707-98-24150	75.68
PAT ANGLE	114-63-02031	2001-	P-U-10	40 mm	90 mm	KOM-707-98-22420	67.66
PAT LIFT	114-63-02011	2001-	P-U-10	40 mm	90 mm	KOM-707-98-22420	67.66
PAT TILT	114-63-02041	2001-	P-U-10	40 mm	90 mm	KOM-707-98-22420	67.66
RIPPER	113-63-42501	2001-	P-U-14	40 mm	90 mm	KOM-707-98-22500	69.13
MODEL D40A-3, D41A-3							
LIFT	12F-63-13701	6001-	P-U-14	45 mm	70 mm	KOM-12F-63-05020	60.04
	12F-63-13801	6001-	P-U-14	45 mm	70 mm	KOM-12F-63-05020	60.04
RIPPER	125-63-42300	6001-	P-U-14	60 mm	120 mm	KOM-707-98-41130	149.01
TRIMMING	124-63-79500	6001-	P-U-14	45 mm	90 mm	KOM-707-98-24530	103.70
	124-63-79600	6001-	P-U-14	45 mm	90 mm	KOM-707-98-24530	103.70
TRIMMING LIFT	124-63-69500	6001-	P-U-14	45 mm	70 mm	KOM-707-98-15650	60.17
	124-63-69600	6001-	P-U-14	45 mm	70 mm	KOM-707-98-15650	60.17
MODEL D40F-3							
TOOL BAR	120-63-48100	6221-	P-U-14	70 mm	140 mm	KOM-707-98-52100	178.76
	120-63-48200	6221-	P-U-14	70 mm	140 mm	KOM-707-98-52100	178.76
MODEL D40P-3, D40PL-3, D40PLL-3, D41P-3							
LIFT	12F-63-13701	6001-	P-U-14	45 mm	70 mm	KOM-12F-63-05020	60.04
	12F-63-13801	6001-	P-U-14	45 mm	70 mm	KOM-12F-63-05020	60.04
TILT	12F-63-52500	6001-	P-U-14	50 mm	100 mm	KOM-12F-63-05060	99.98
MODEL D41E-3							
LIFT	12F-63-13701	6001-	P-U-14	45 mm	70 mm	KOM-12F-63-05020	60.04
	12F-63-13801	6001-	P-U-14	45 mm	70 mm	KOM-12F-63-05020	60.04
PAT ANGLE	124-63-55500	6001-	P-U-14	65 mm	100 mm	KOM-707-98-36180	102.46

Replacement Kits For

KOMATSU

KOMATSU

Crawler Dozers							
APPLICATION	CYL #	SERIAL #	CODE	ROD	BORE	KIT #	List \$
MODEL D41E-3							
PAT ANGLE	124-63-55600	6001-	P-U-14	65 mm	100 mm	KOM-707-98-36180	102.46
PAT TILT	124-63-54500	6001-	P-U-14	60 mm	120 mm	KOM-707-98-41120	119.83
TILT	12F-63-52500	6001-	P-U-14	50 mm	100 mm	KOM-12F-63-05060	99.98
MODEL D41Q-3, D41S-3							
LIFT	125-63-22701	6001-	P-U-14	60 mm	110 mm	KOM-707-98-35510	119.28
	125-63-22801	6001-	P-U-14	60 mm	110 mm	KOM-707-98-35510	119.28
MULTI-PURPOSE BUCKET CLAM	125-63-59500	6001-	P-U-14	50 mm	90 mm	KOM-707-98-25510	111.79
SIDE DUMP	125-63-97500	6001-	P-U-14	50 mm	80 mm	KOM-707-98-25170	113.16
MODEL D50A-16, D53A-16							
LIFT	130-63-12005	65001-	P-U-5	55 mm	90 mm	KOM-707-99-26410	83.35
	130-63-12105	65001-	P-U-5	55 mm	90 mm	KOM-707-99-26410	83.35
MODEL D50A-17, D53A-17							
MAP TILT	144-63-53300	80001-	P-U-14	70 mm	160 mm	KOM-707-98-60110	113.83
	144-63-53400	80001-	P-U-14	70 mm	160 mm	KOM-707-98-60110	113.83
MODEL D50P-16							
LIFT	13F-63-13100	65001-65007	P-U-5	55 mm	90 mm	KOM-130-63-05020	83.35
	13F-63-13101	65008-	P-U-5	55 mm	90 mm	KOM-130-63-05020	83.35
	13F-63-13200	65001-65007	P-U-5	55 mm	90 mm	KOM-130-63-05020	83.35
	13F-63-13201	65008-	P-U-5	55 mm	90 mm	KOM-130-63-05020	83.35
MODEL D50P-17, D50PL-17, D53P-17							
TILT	130-63-52500	80001-	P-U-14	70 mm	160 mm	KOM-707-98-60120	115.01
MODEL D53P-16							
LIFT	13F-63-13100	65280-	P-U-5	55 mm	90 mm	KOM-130-63-05020	83.35
	13F-63-13200	65280-	P-U-5	55 mm	90 mm	KOM-130-63-05020	83.35
MODEL D53S-17							
DUMP	131-63-32004	80001-	P-U-14	65 mm	130 mm	KOM-707-98-42410	167.69
	131-63-32104	80001-	P-U-14	65 mm	130 mm	KOM-707-98-42410	167.69
LIFT	131-63-22005	80001-	P-U-14	65 mm	140 mm	KOM-707-98-51100	146.98
	131-63-22105	80001-	P-U-14	65 mm	140 mm	KOM-707-98-51100	146.98
MODEL D57S-1							
BOTH-SIDE DUMP	135-63-93100	-9000	P-U-5	55 mm	100 mm	KOM-707-99-34030	85.08
DUMP	135-63-32305	6501-9000	P-U-5	65 mm	140 mm	KOM-707-98-51110	141.66
	135-63-32306	9001-	P-U-14	65 mm	140 mm	KOM-707-98-51100	146.98
	135-63-32406	6501-9000	P-U-5	65 mm	140 mm	KOM-707-98-51110	141.66
	135-63-32407	9001-	P-U-14	65 mm	140 mm	KOM-707-98-51100	146.98
LIFT	135-63-22305	9001-	P-U-14	70 mm	150 mm	KOM-707-98-52430	130.22
	135-63-22405	9001-	P-U-14	70 mm	150 mm	KOM-707-98-52430	130.22
MODEL D58E-1							
MAP TILT	144-63-53300	80888-	P-U-14	70 mm	160 mm	KOM-707-98-60110	113.83
	144-63-53400	80888-	P-U-14	70 mm	160 mm	KOM-707-98-60110	113.83
TILT	130-63-52500	80888-	P-U-14	70 mm	160 mm	KOM-707-98-60120	115.01
MODEL D58P-1							
TILT	130-63-52500	80588-	P-U-14	70 mm	160 mm	KOM-707-98-60120	115.01
MODEL D60A-7, D60E-7, D65A-7, D65E-7							
LIFT	144-63-12501	40001-	P-U-14	65 mm	110 mm	KOM-707-99-36420	117.11
	144-63-12601	40001-	P-U-14	65 mm	110 mm	KOM-707-99-36420	117.11

Replacement Kits For

KOMATSU

KOMATSU

Crawler Dozers							
APPLICATION	CYL #	SERIAL #	CODE	ROD	BORE	KIT #	List \$
MODEL D60A-8, D65A-8							
LIFT	144-63-12502	45001-	P-U-14	65 mm	110 mm	KOM-144-63-05050	123.91
	144-63-12602	45001-	P-U-14	65 mm	110 mm	KOM-144-63-05050	123.91
MAP TILT	144-63-53300	45001-	P-U-14	70 mm	160 mm	KOM-707-98-60110	113.83
	144-63-53400	45001-	P-U-14	70 mm	160 mm	KOM-707-98-60110	113.83
RIPPER	144-63-42100	45001-	P-U-14	75 mm	160 mm	KOM-707-98-61100	146.48
TRIMMING	144-63-97300	45001-	P-U-14	55 mm	120 mm	KOM-707-99-40040	133.37
	144-63-97400	45001-	P-U-14	55 mm	120 mm	KOM-707-99-40040	133.37
TRIMMING LIFT	144-63-69500	45001-	P-U-14	65 mm	110 mm	KOM-707-99-36420	117.11
	144-63-69600	45001-	P-U-14	65 mm	110 mm	KOM-707-99-36420	117.11
MODEL D60E-8							
LIFT	144-63-13502	45001-	P-N-14	65 mm	110 mm	KOM-144-63-05020	96.40
	144-63-13602	45001-	P-N-14	65 mm	110 mm	KOM-144-63-05020	96.40
RIPPER	144-63-42100	45001-	P-U-14	75 mm	160 mm	KOM-707-98-61100	146.48
TILT	144-63-52200	45001-	P-U-14	70 mm	160 mm	KOM-144-63-05080	113.95
MODEL D60P-7, D60PL-7, D65P-7							
LIFT	144-63-13502	40001-	P-N-14	65 mm	110 mm	KOM-144-63-05020	96.40
	144-63-13602	40001-	P-N-14	65 mm	110 mm	KOM-144-63-05020	96.40
TILT	144-63-52200	40001-	P-U-14	70 mm	160 mm	KOM-144-63-05080	113.95
MODEL D60P-8, D60PL-8							
LIFT	144-63-13503	45001-	P-U-14	65 mm	110 mm	KOM-144-63-05050	123.91
	144-63-13603	45001-	P-U-14	65 mm	110 mm	KOM-144-63-05050	123.91
TILT	144-63-52200	45001-	P-U-14	70 mm	160 mm	KOM-144-63-05080	113.95
MODEL D60S-7, D65S-7							
DUMP	141-63-32300	40001-	P-U-14	60 mm	140 mm	KOM-141-63-05010	130.90
	141-63-32400	40001-	P-U-14	60 mm	140 mm	KOM-141-63-05010	130.90
LIFT	141-63-22300	40001-	P-U-14	75 mm	160 mm	KOM-141-63-05050	148.52
	141-63-22400	40001-	P-U-14	75 mm	160 mm	KOM-141-63-05050	148.52
MODEL D60S-8, D65S-8							
DUMP	141-63-32300	45001-	P-U-14	60 mm	140 mm	KOM-141-63-05010	130.90
	141-63-32400	45001-	P-U-14	60 mm	140 mm	KOM-141-63-05010	130.90
LIFT	141-63-22300	45001-	P-U-14	75 mm	160 mm	KOM-141-63-05050	148.52
	141-63-22400	45001-	P-U-14	75 mm	160 mm	KOM-141-63-05050	148.52
MODEL D63E-1							
MAP TILT	144-63-53300	1001-	P-U-14	70 mm	160 mm	KOM-707-98-60110	113.83
	144-63-53400	1001-	P-U-14	70 mm	160 mm	KOM-707-98-60110	113.83
TILT	130-63-52500	1001-	P-U-14	70 mm	160 mm	KOM-707-98-60120	115.01
MODEL D65A-6							
LIFT	144-60-00040	20006-20021	P-U-10	65 mm	110 mm	KOM-144-60-00050K	105.26
	144-60-00041	20024-	P-U-10	65 mm	110 mm	KOM-144-60-00050K	105.26
	144-60-00050	20006-20021	P-U-10	65 mm	110 mm	KOM-144-60-00050K	105.26
	144-60-00051	20024-	P-U-10	65 mm	110 mm	KOM-144-60-00050K	105.26
	144-60-15004	-28883	P-U-10	65 mm	110 mm	KOM-144-60-00050K	105.26
	144-60-15104	-28883	P-U-10	65 mm	110 mm	KOM-144-60-00050K	105.26
	144-63-12100	28884-	P-U-5	65 mm	110 mm	KOM-144-63-12200K	152.72
	144-63-12200	28884-	P-U-5	65 mm	110 mm	KOM-144-63-12200K	152.72
MODEL D65E-8							
LIFT	144-63-12502	45001-	P-U-14	65 mm	110 mm	KOM-144-63-05050	123.91
	144-63-12602	45001-	P-U-14	65 mm	110 mm	KOM-144-63-05050	123.91

Replacement Kits For

KOMATSU

KOMATSU

Crawler Dozers							
APPLICATION	CYL #	SERIAL #	CODE	ROD	BORE	KIT #	List \$
MODEL D65E-8							
RIPPER	144-63-42100	45001-	P-U-14	75 mm	160 mm	KOM-707-98-61100	146.48
TILT	144-63-52200	45001-	P-U-14	70 mm	160 mm	KOM-144-63-05080	113.95
MODEL D65P-6							
LIFT	144-63-13100	30001-32000	P-U-5	65 mm	110 mm	KOM-144-63-12200K	152.72
	144-63-13200	30001-32000	P-U-5	65 mm	110 mm	KOM-144-63-12200K	152.72
	144-63-13300	30001-	P-U-5	65 mm	110 mm	KOM-144-63-12200K	152.72
	144-63-13400	30001-	P-U-5	65 mm	110 mm	KOM-144-63-12200K	152.72
TILT	144-63-52100	30001-31000	P-U-5	70 mm	160 mm	KOM-144-63-52100K	214.43
	144-63-52101	31001-	P-U-5	70 mm	160 mm	KOM-144-63-52100K	214.43
MODEL D65P-7							
TILT	144-63-5220	40001-	P-U-14	70 mm	160 mm	KOM-144-63-05080	113.95
MODEL D65P-8							
LIFT	144-63-13503	45001-	P-U-14	65 mm	110 mm	KOM-144-63-05050	123.91
	144-63-13603	45001-	P-U-14	65 mm	110 mm	KOM-144-63-05050	123.91
TILT	144-63-52200	45001-	P-U-14	70 mm	160 mm	KOM-144-63-05080	113.95
MODEL D66S-1							
BOTH-SIDE DUMP	142-63-99101	1001-	P-U-14	60 mm	120 mm	KOM-707-98-41140	149.14
DUMP	142-63-32300	1001-	P-U-14	100 mm	180 mm	KOM-707-98-66410	256.48
LIFT	142-63-22200	1001-	P-U-14	80 mm	150 mm	KOM-707-98-54510	142.22
MULTI-PURPOSE BUCKET CLAM	142-63-59101	1001-	P-U-14	60 mm	120 mm	KOM-707-98-41130	149.01
	142-63-59201	1001-	P-U-14	60 mm	120 mm	KOM-707-98-41130	149.01
MODEL D68E-1							
LIFT	144-63-16100	1001-	P-U-14	65 mm	110 mm	KOM-144-63-05050	123.91
	144-63-16200	1001-	P-U-14	65 mm	110 mm	KOM-144-63-05050	123.91
MODEL D68P-1							
LIFT	144-63-13503	45590-	P-U-14	65 mm	110 mm	KOM-144-63-05050	123.91
	144-63-13603	45590-	P-U-14	65 mm	110 mm	KOM-144-63-05050	123.91
RIPPER			P-U-14	75 mm	160 mm	KOM-707-98-61100	146.48
TILT	144-63-52200	45590-	P-U-14	70 mm	160 mm	KOM-144-63-05080	113.95
MODEL D75A-1							
ANGLE LIFT	144-63-12502	50001-	P-U-14	65 mm	110 mm	KOM-144-63-05050	123.91
	144-63-12602	50001-	P-U-14	65 mm	110 mm	KOM-144-63-05050	123.91
RIPPER	144-63-42100	50001-	P-U-14	75 mm	160 mm	KOM-707-98-61100	146.48
STT LIFT	144-63-16100	50001-	P-U-14	65 mm	110 mm	KOM-144-63-05050	123.91
	144-63-16200	50001-	P-U-14	65 mm	110 mm	KOM-144-63-05050	123.91
TILT	144-63-52200	50001-	P-U-14	70 mm	160 mm	KOM-144-63-05080	113.95
MODEL D75S-3							
DUMP	145-63-32601	7001-10000	P-U-14	70 mm	150 mm	KOM-707-98-52410	143.88
	145-63-32602	10001-	P-U-14	70 mm	150 mm	KOM-707-98-52410	143.88
	145-63-32701	7001-10000	P-U-14	70 mm	150 mm	KOM-707-98-52410	143.88
	145-63-32702	10001-	P-U-14	70 mm	150 mm	KOM-707-98-52410	143.88
LIFT	145-63-23300	7001-10000	P-U-14	90 mm	180 mm	KOM-707-98-64450	128.43
	145-63-23301	10001-	P-U-14	90 mm	180 mm	KOM-707-98-64420	134.65
	145-63-23400	7001-10000	P-U-14	90 mm	180 mm	KOM-707-98-64450	128.43
	145-63-23401	10001-	P-U-14	90 mm	180 mm	KOM-707-98-64420	134.65
MODEL D75S-5							
DUMP	145-63-32602	15001-	P-U-14	70 mm	150 mm	KOM-707-98-52410	143.88

Replacement Kits For

KOMATSU

KOMATSU

Crawler Dozers							
APPLICATION	CYL #	SERIAL #	CODE	ROD	BORE	KIT #	List \$
MODEL D75S-5							
DUMP	145-63-32702	15001-	P-U-14	70 mm	150 mm	KOM-707-98-52410	143.88
DUMP (SCORIA)	145-63-33600	15001-	P-U-14	70 mm	150 mm	KOM-707-98-52410	143.88
	145-63-33700	15001-	P-U-14	70 mm	150 mm	KOM-707-98-52410	143.88
LIFT	145-63-23301	15001-	P-U-14	90 mm	180 mm	KOM-707-98-64420	134.65
	145-63-23401	15001-	P-U-14	90 mm	180 mm	KOM-707-98-64420	134.65
LIFT (SCORIA)	145-63-23800	15001-	P-U-14	90 mm	180 mm	KOM-707-98-64450	128.43
	145-63-23900	15001-	P-U-14	90 mm	180 mm	KOM-707-98-64450	128.43
SIDE DUMP	145-63-97101	15001-	P-U-5	60 mm	110 mm	KOM-707-99-36410	104.38
MODEL D80A-18							
LIFT	154-63-12604	25001-	P-U-5	70 mm	120 mm	KOM-707-99-43010	119.09
	154-63-12704	25001-	P-U-5	70 mm	120 mm	KOM-707-99-43010	119.09
MAP TILT	154-63-52500	25001-	P-U-14	70 mm	160 mm	KOM-707-98-60121	113.90
	154-63-52600	25001-	P-U-14	70 mm	160 mm	KOM-707-98-60120	115.01
RIPPER	154-63-42503	25001-	P-U-14	70 mm	150 mm	KOM-707-98-52410	143.88
	154-63-42603	25001-	P-U-14	70 mm	150 mm	KOM-707-98-52410	143.88
TILT	154-63-52402	25001-26042	P-U-14	90 mm	200 mm	KOM-707-99-71100	159.03
TRIMMING	154-63-79400	25001-	P-U-14	70 mm	150 mm	KOM-707-98-52410	143.88
MODEL D80E-18							
RIPPER	154-63-42503	25001-	P-U-14	70 mm	150 mm	KOM-707-98-52410	143.88
	154-63-42603	25001-	P-U-14	70 mm	150 mm	KOM-707-98-52410	143.88
TILT	154-63-52402	25001-26042	P-U-14	90 mm	200 mm	KOM-707-99-71100	159.03
MODEL D83E-1							
MAP TILT	154-63-52500	1001-	P-U-14	70 mm	160 mm	KOM-707-98-60121	113.90
	154-63-52600	1001-	P-U-14	70 mm	160 mm	KOM-707-98-60120	115.01
RIPPER	144-63-42100	1001-	P-U-14	75 mm	160 mm	KOM-707-98-61100	146.48
TILT	144-63-52200	1001-	P-U-14	70 mm	160 mm	KOM-144-63-05080	113.95
MODEL D83P-1							
TILT	144-63-52200	1001-	P-U-14	70 mm	160 mm	KOM-144-63-05080	113.95
MODEL D85A-18							
LIFT	154-63-12604	25001-	P-U-5	70 mm	120 mm	KOM-707-99-43010	119.09
	154-63-12704	25001-	P-U-5	70 mm	120 mm	KOM-707-99-43010	119.09
MAP TILT	154-63-52500	25001-	P-U-14	70 mm	160 mm	KOM-707-98-60121	113.90
	154-63-52600	25001-	P-U-14	70 mm	160 mm	KOM-707-98-60120	115.01
RIPPER	154-63-42503	25001-	P-U-14	70 mm	150 mm	KOM-707-98-52410	143.88
	154-63-42603	25001-	P-U-14	70 mm	150 mm	KOM-707-98-52410	143.88
TILT	154-63-52402	25001-28323	P-U-14	90 mm	200 mm	KOM-707-99-71100	159.03
TRIMMING	154-63-79400	25001-	P-U-14	70 mm	150 mm	KOM-707-98-52410	143.88
MODEL D85A-21, D85E-21							
MAP TILT	154-63-02120	35001-	P-U-14	70 mm	140 mm	KOM-707-98-52110	171.03
	154-63-02130	35001-	P-U-14	70 mm	140 mm	KOM-707-98-52110	171.03
RIPPER	154-63-02081	35001-	P-U-14	70 mm	140 mm	KOM-707-98-52110	171.03
TILT	154-63-02070	35001-	P-U-14	80 mm	160 mm	KOM-707-98-62120	131.58
MODEL D85E-18							
RIPPER	154-63-42503	25001-	P-U-14	70 mm	150 mm	KOM-707-98-52410	143.88
	154-63-42603	25001-	P-U-14	70 mm	150 mm	KOM-707-98-52410	143.88
TILT	154-63-52402	25001-28323	P-U-14	90 mm	200 mm	KOM-707-99-71100	159.03
MODEL D85P-21							
TILT	154-63-02070	3001-	P-U-14	80 mm	160 mm	KOM-707-98-62120	131.58

Replacement Kits For

KOMATSU

KOMATSU

Crawler Dozers							
APPLICATION	CYL #	SERIAL #	CODE	ROD	BORE	KIT #	List \$
MODEL D95S-2							
LIFT	155-63-22501	2112-	P-U-14	90 mm	180 mm	KOM-707-98-64450	128.43
	155-63-22601	2112-	P-U-14	90 mm	180 mm	KOM-707-98-64450	128.43
MODEL D135A-1							
LIFT	15A-63-02010	10001-	P-U-14	80 mm	130 mm	KOM-707-98-45610	156.31
RIPPER LIFT	15A-63-02140	10001-	P-U-14	80 mm	160 mm	KOM-707-98-62100	109.56
	15A-63-02150	10001-	P-U-14	80 mm	160 mm	KOM-707-98-62100	109.56
RIPPER TILT	15A-63-02160	10001-	P-U-14	80 mm	150 mm	KOM-707-98-54500	225.70
	15A-63-02170	10001-	P-U-14	80 mm	150 mm	KOM-707-98-54500	225.70
TILT	15A-63-02130	10001-	P-U-14	90 mm	180 mm	KOM-707-98-64410	133.13
MODEL D135A-2							
LIFT	15A-63-02010	10301-	P-U-14	80 mm	130 mm	KOM-707-98-45610	156.31
RIPPER LIFT	15A-63-02140	10301-	P-U-14	80 mm	160 mm	KOM-707-98-62100	109.56
	15A-63-02150	10301-	P-U-14	80 mm	160 mm	KOM-707-98-62100	109.56
RIPPER TILT	15A-63-02160	10301-	P-U-14	80 mm	150 mm	KOM-707-98-54500	225.70
	15A-63-02170	10301-	P-U-14	80 mm	150 mm	KOM-707-98-54500	225.70
TILT	15A-63-02130	10301-	P-U-14	90 mm	180 mm	KOM-707-98-64410	133.13
MODEL D155A-1							
RIPPER LIFT	175-63-42700	17001-	P-U-14	90 mm	225 mm	KOM-707-99-71420	190.21
	175-63-42800	17001-	P-U-14	90 mm	225 mm	KOM-707-99-71420	190.21
RIPPER TILT	175-63-43700	17001-	P-U-14	90 mm	225 mm	KOM-707-99-71420	190.21
	175-63-43800	17001-	P-U-14	90 mm	225 mm	KOM-707-99-71420	190.21
TILT	175-63-52700	20004-	P-U-14	90 mm	225 mm	KOM-175-63-05140	226.23
MODEL D155A-2							
LIFT	175-63-02111	50001-	P-U-14	75 mm	140 mm	KOM-707-98-53100	209.92
RIPPER LIFT	175-63-42701	50001-	P-U-14	90 mm	225 mm	KOM-707-99-71420	190.21
	175-63-42801	50001-	P-U-14	90 mm	225 mm	KOM-707-99-71420	190.21
RIPPER TILT	175-63-43700	50001-	P-U-14	90 mm	225 mm	KOM-707-99-71420	190.21
	175-63-43800	50001-	P-U-14	90 mm	225 mm	KOM-707-99-71420	190.21
TILT	175-63-52700	50001-	P-U-14	90 mm	225 mm	KOM-175-63-05140	226.23
MODEL D375A-1							
LIFT	195-63-01101	15001-	P-U-14	90 mm	150 mm	KOM-707-98-56600	130.03
	195-63-01201	15001-	P-U-14	90 mm	150 mm	KOM-707-98-56600	130.03
RIPPER TILT	195-63-01501	15001-	P-U-14	110 mm	200 mm	KOM-707-98-74100	264.34
	195-63-01601	15001-	P-U-14	110 mm	200 mm	KOM-707-98-74100	264.34
TILT	195-63-53200	15001-15413	P-U-14	110 mm	225 mm	KOM-707-98-74410	257.76
	195-63-53200	15417-15422	P-U-14	110 mm	225 mm	KOM-707-98-74410	257.76
	195-63-53400	15423-	P-U-14	110 mm	225 mm	KOM-707-98-74420	260.52
	195-63-53400	15414-15416	P-U-14	110 mm	225 mm	KOM-707-98-74420	260.52
MODEL D375A-2							
LIFT	195-63-01410	16001-	P-U-14	90 mm	150 mm	KOM-707-98-56610	139.32
	195-63-01420	16001-	P-U-14	90 mm	150 mm	KOM-707-98-56610	139.32
RIPPER TILT	195-63-01501	16001-	P-U-14	110 mm	200 mm	KOM-707-98-74100	264.34
	195-63-01601	16001-	P-U-14	110 mm	200 mm	KOM-707-98-74100	264.34
MODEL D475A-1							
TILT (K LINK)	198-63-02130	10001-	P-U-14	140 mm	250 mm	KOM-707-98-84011	367.50
MODEL D475A-2							
TILT	198-63-02130	10201-	P-U-14	140 mm	250 mm	KOM-707-98-84011	367.50

Replacement Kits For

KOMATSU

KOMATSU

Dump Trucks							
APPLICATION	CYL #	SERIAL #	CODE	ROD	BORE	KIT #	List \$
MODEL HD325-3							
STEERING	566-63-11500	1501-	P-U-14	60 mm	80 mm	KOM-707-98-27100	87.30
MODEL HD325-5							
STEERING	566-63-11500	2001-	P-U-14	60 mm	80 mm	KOM-707-98-27100	87.30
MODEL HD465-3							
STEERING	569-63-41203	2001-	P-U-14	60 mm	80 mm	KOM-707-98-27100	87.30
STEERING (LT)	569-63-41303	2001-	P-U-14	60 mm	80 mm	KOM-707-98-27100	87.30
MODEL HD785-3							
STEERING	561-63-61102	2001-	P-U-14	70 mm	110 mm	KOM-707-98-37570	107.16
MODEL HD1200M-1							
TAILGATE	566-63-41001		P-U-14	75 mm	140 mm	KOM-707-98-53100	209.92
	568-63-12101		P-U-14	75 mm	140 mm	KOM-707-98-53100	209.92
Excavators - Tracked							
APPLICATION	CYL #	SERIAL #	CODE	ROD	BORE	KIT #	List \$
MODEL PC15R-8							
ARM	20W-63-02121	(10001-)	P-U-14	30 mm	50 mm	KOM-707-98-04640	52.70
BLADE	20W-63-02150	(10001-)	P-U-14	35 mm	70 mm	KOM-707-98-12660	42.04
BOOM (CAB)	20W-63-02160	(10001-)	P-U-14	35 mm	60 mm	KOM-707-98-12330	40.95
BOOM (CANOPY)	20W-63-02111	(10001-)	P-U-14	35 mm	60 mm	KOM-707-98-12330	40.95
BOOM (SWING)	20M-63-02140	(10001-)	P-U-14	30 mm	60 mm	KOM-707-98-11310	29.14
BUCKET	20M-63-02130	(10001-)	P-U-14	30 mm	50 mm	KOM-707-98-04640	52.70
MODEL PC20-5							
ARM	20R-63-66300	18001-	P-U-14	40 mm	80 mm	KOM-707-98-22120	77.67
BLADE	20S-63-96300	18001-	P-U-14	45 mm	90 mm	KOM-707-98-24600	105.54
BOOM	20R-63-56500	18001-	P-U-14	40 mm	80 mm	KOM-707-98-22030	84.28
BOOM SWING	20S-63-86301	18001-	P-U-14	35 mm	70 mm	KOM-707-98-12440	51.51
BUCKET	20R-63-76301	18001-	P-U-14	35 mm	70 mm	KOM-707-98-12440	51.51
MODEL PC27R-8							
ARM	20P-63-02522	(10001-)	P-U-14	40 mm	70 mm	KOM-707-98-14610	41.85
BLADE	20P-63-02552	(10001-)	P-U-14	35 mm	70 mm	KOM-707-98-12670	41.85
BLADE LIFT	20P-63-02140	(10001-)	P-U-14	35 mm	70 mm	KOM-707-98-12410	41.85
BOOM (CAB)	20P-63-02512	(10001-)	P-U-14	45 mm	75 mm	KOM-707-98-24890	110.04
BOOM (CANOPY)	20P-63-02502	(10001-)	P-U-14	45 mm	75 mm	KOM-707-98-24890	110.04
BOOM (SWING)	20P-63-02541	(10001-)	P-U-14	40 mm	80 mm	KOM-707-98-23130	63.28
BUCKET	20P-63-02531	(10001-)	P-U-14	35 mm	60 mm	KOM-707-98-12310	40.95
MODEL PC30-5							
ARM	20S-63-66300	6001-	P-U-14	40 mm	80 mm	KOM-707-98-22120	77.67
BLADE	20S-63-96300	6001-	P-U-14	45 mm	90 mm	KOM-707-98-24600	105.54
BOOM	20S-63-56500	6001-	P-U-14	40 mm	80 mm	KOM-707-98-22030	84.28
BOOM SWING	20S-63-86300	6001-	P-U-14	35 mm	70 mm	KOM-707-98-12440	51.51
BUCKET	20S-63-76102	6001-	P-U-14	40 mm	70 mm	KOM-707-98-14430	60.47
MODEL PC30-6							
BLADE TILT	20U-63-02090	10001-	P-U-14	45mm	90 mm	KOM-707-98-24550	45.85
MODEL PC40-5							
BLADE	20S-63-96300	8501-	P-U-14	45 mm	90 mm	KOM-707-98-24600	105.54
BOOM SWING	20T-63-02040	8501-	P-U-14	50 mm	90 mm	KOM-707-98-25500	100.80
MODEL PC40-6							
BLADE	20T-63-02091	10001-	P-U-14	60 mm	100 mm	KOM-707-98-35100	71.02
	20U-63-02080	13022-	P-U-14	60 mm	100 mm	KOM-707-98-35100	71.02

Replacement Kits For

KOMATSU

KOMATSU

Excavators - Tracked							
APPLICATION	CYL #	SERIAL #	CODE	ROD	BORE	KIT #	List \$
MODEL PC40-6							
BLADE TILT	20U-63-02090	11899-	P-U-14	45mm	90 mm	KOM-707-98-24550	45.85
BOOM SWING	20T-63-02140	10001-	P-U-14	50 mm	90 mm	KOM-707-98-25510	111.79
MODEL PC50UU-1							
ARM	20U-63-02020	1001-1566	P-U-14	55 mm	80 mm	KOM-707-98-26110	67.78
	20U-63-02021	1567-	P-U-14	55 mm	80 mm	KOM-707-98-26110	67.78
BLADE	20U-63-02050	1001-1766	P-U-14	60 mm	100 mm	KOM-707-98-35100	71.02
	20U-63-02051	1767-3400	P-U-14	60 mm	100 mm	KOM-707-98-35100	71.02
	20U-63-02080	3401-	P-U-14	60 mm	100 mm	KOM-707-98-35100	71.02
BLADE TILT	20U-63-02090	3401-	P-U-14	45mm	90 mm	KOM-707-98-24550	45.85
BOOM	20U-63-02060	1001-3400	P-U-14	55 mm	100 mm	KOM-707-98-34120	72.78
	20U-63-02062	3401-	P-U-14	55 mm	100 mm	KOM-707-98-34120	72.78
MODEL PC60-5							
ARM	201-63-02020	20501-	P-U-14	60 mm	90 mm	KOM-707-98-27500	108.52
BLADE	201-63-02070	20501-	P-U-14	60 mm	100 mm	KOM-707-98-35130	123.06
	201-63-02080	20501-	P-U-14	60 mm	100 mm	KOM-707-98-35130	123.06
BOOM	201-63-02010	20501-	P-U-14	65 mm	100 mm	KOM-707-99-36260	125.58
MODEL PC60L-5							
ARM	201-63-02020	7501-	P-U-14	60 mm	90 mm	KOM-707-98-27500	108.52
BOOM	201-63-02010	7501-	P-U-14	65 mm	100 mm	KOM-707-99-36260	125.58
MODEL PC60U-5							
ARM	201-63-02050	4501-	P-U-14	60 mm	90 mm	KOM-707-98-27500	108.52
BLADE	201-63-02070	4501-	P-U-14	60 mm	100 mm	KOM-707-98-35130	123.06
	201-63-02080	4501-	P-U-14	60 mm	100 mm	KOM-707-98-35130	123.06
BOOM	201-63-02040	4501-	P-U-14	65 mm	100 mm	KOM-707-99-36260	125.58
MODEL PC75UU-1							
ARM	21W-63-02021	1001-	P-U-14	60 mm	90 mm	KOM-707-98-27500	108.52
BLADE	21W-63-02051	1001-	P-U-14	70 mm	130 mm	KOM-707-98-43510	177.45
MODEL PC80-3,PC80LC-3							
ARM	20X-63-02020	2001-	P-U-14	65 mm	100 mm	KOM-707-99-36270	125.46
MODEL PC90-1							
ARM	20X-63-02210	1001-	P-U-14	65 mm	105 mm	KOM-707-99-36620	206.47
BOOM	20X-63-02200	1001-	P-UB-14	70 mm	110 mm	KOM-707-99-37610	219.26
MODEL PC100-1, PC100-2							
ARM	202-63-62140		P-U-14	70 mm	120 mm	KOM-707-99-43100	125.27
MODEL PC100-3							
ARM	202-63-62500	10001-19852	P-U-14	75 mm	110 mm	KOM-707-98-38600	124.10
	202-63-69300	19853-	P-U-14	75 mm	110 mm	KOM-707-98-38600	124.10
BOOM	202-63-52500	18001-22872	P-UB-14	65 mm	100 mm	KOM-707-98-36100	105.36
	202-63-52600	18001-22872	P-UB-14	65 mm	100 mm	KOM-707-98-36100	105.36
	202-63-59300	22873-	P-UB-14	65 mm	100 mm	KOM-707-99-36200	152.42
	202-63-59400	22873-	P-UB-14	65 mm	100 mm	KOM-707-99-36200	152.42
BUCKET	203-63-72500	10001-19852	P-UB-14	65 mm	100 mm	KOM-707-98-36110	78.84
	203-63-79300	19853-	P-UB-14	65 mm	100 mm	KOM-707-99-36210	125.83
MODEL PC100-5							
ARM	202-63-02120	28001-	P-UB-14	75 mm	115 mm	KOM-707-99-44200	243.12
BOOM	202-63-02100	28001-	P-UB-14	65 mm	95 mm	KOM-707-98-36200	187.23
BUCKET	202-63-02130	28001-	P-UB-14	60 mm	90 mm	KOM-707-98-27600	150.64

Replacement Kits For

KOMATSU

KOMATSU

Excavators - Tracked							
APPLICATION	CYL #	SERIAL #	CODE	ROD	BORE	KIT #	List \$
MODEL PC100L-3							
ARM	202-63-62500	12001-12137	P-U-14	75 mm	110 mm	KOM-707-98-38600	124.10
	202-63-69300	12138-	P-U-14	75 mm	110 mm	KOM-707-98-38600	124.10
BOOM	202-63-52500	12001-12367	P-UB-14	65 mm	100 mm	KOM-707-98-36100	105.36
	202-63-52600	12001-12367	P-UB-14	65 mm	100 mm	KOM-707-98-36100	105.36
	202-63-59300	12368-	P-UB-14	65 mm	100 mm	KOM-707-99-36200	152.42
	202-63-59400	12368-	P-UB-14	65 mm	100 mm	KOM-707-99-36200	152.42
BUCKET	203-63-72500	12001-12137	P-UB-14	65 mm	100 mm	KOM-707-98-36110	78.84
	203-63-79300	12138-	P-UB-14	65 mm	95 mm	KOM-707-98-36210	160.34
MODEL PC100L-5							
ARM	202-63-02120	14001-	P-UB-14	75 mm	115 mm	KOM-707-99-44200	243.12
BOOM	202-63-02100	14001-	P-UB-14	65 mm	95 mm	KOM-707-98-36200	187.23
BUCKET	202-63-02130	14001-	P-UB-14	60 mm	90 mm	KOM-707-98-27600	150.64
MODEL PC100U-3							
ARM	202-63-62500	12001-12019	P-U-14	75 mm	110 mm	KOM-707-98-38600	124.10
	202-63-62502	12020-	P-U-14	75 mm	110 mm	KOM-707-98-38600	124.10
	203-63-62340		P-U-14	80 mm	130 mm	KOM-707-98-45700	185.32
BOOM	202-63-53500	12001-	P-UB-14	65 mm	100 mm	KOM-707-98-36100	105.36
	202-63-53600	12001-	P-UB-14	65 mm	100 mm	KOM-707-98-36100	105.36
	203-63-52340		P-U-14	70 mm	120 mm	KOM-707-99-43100	125.27
BOOM SWING	202-63-13501	12001-	P-U-14	75 mm	120 mm	KOM-707-98-44120	157.74
BUCKET	202-63-72500	12001-12019	P-UB-14	65 mm	100 mm	KOM-707-98-36110	78.84
	203-63-72340		P-U-14	70 mm	120 mm	KOM-707-99-43100	125.27
	203-63-72501	12020-	P-UB-14	65 mm	100 mm	KOM-707-98-36110	78.84
MODEL PC120-3							
ARM	203-63-62500	18001-20335	P-U-14	75 mm	110 mm	KOM-707-98-38600	124.10
	203-63-62502	20336-24709	P-U-14	75 mm	110 mm	KOM-707-98-38600	124.10
	203-63-69300	24710-	P-U-14	75 mm	110 mm	KOM-707-98-38600	124.10
BOOM	203-63-52500	18001-24709	P-U-14	70 mm	110 mm	KOM-707-98-37500	114.77
	203-63-52600	18001-24709	P-U-14	70 mm	110 mm	KOM-707-98-37500	114.77
	203-63-59300	24710-	P-UB-14	70 mm	110 mm	KOM-707-99-37600	137.21
	203-63-59400	24710-	P-UB-14	70 mm	110 mm	KOM-707-99-37600	137.21
BUCKET	203-63-72500	18001-20335	P-UB-14	65 mm	100 mm	KOM-707-98-36110	78.84
	203-63-79300	20336-	P-UB-14	65 mm	100 mm	KOM-707-99-36210	125.83
MODEL PC120-5							
ARM	203-63-02120	30001-	P-UB-14	75 mm	115 mm	KOM-707-99-44200	243.12
BOOM	203-63-02100	30001-	P-UB-14	70 mm	105 mm	KOM-707-98-37620	200.28
BUCKET	203-63-02130	30001-	P-UB-14	65 mm	95 mm	KOM-707-98-36210	160.34
MODEL PC150-3							
ARM	21K-63-66500	3001-4369	P-U-14	80 mm	120 mm	KOM-707-98-45200	162.93
	21K-63-66501	4370-	P-U-14	80 mm	120 mm	KOM-707-98-45200	162.93
BOOM	21K-63-56500	3001-4207	P-U-14	75 mm	110 mm	KOM-707-98-38510	117.24
	21K-63-56501	4208-	P-U-14	75 mm	110 mm	KOM-707-98-38510	117.24
	21K-63-56600	3001-4207	P-U-14	75 mm	110 mm	KOM-707-98-38510	117.24
	21K-63-56601	4208-	P-U-14	75 mm	110 mm	KOM-707-98-38510	117.24
BUCKET	21K-63-76500	3001-3480	P-UB-14	70 mm	100 mm	KOM-707-98-37110	134.05
	21K-63-76501	3481-	P-UB-14	70 mm	100 mm	KOM-707-98-37130	109.88
MODEL PC150-5							
ARM	21K-63-02120	6001-	P-UB-14	85 mm	120 mm	KOM-707-99-46200	269.72

Replacement Kits For

KOMATSU

KOMATSU

Excavators - Tracked							
APPLICATION	CYL #	SERIAL #	CODE	ROD	BORE	KIT #	List \$
MODEL PC150-5							
BOOM	21K-63-02100	6001-	P-UB-14	75 mm	110 mm	KOM-707-98-38520	208.32
BUCKET	21K-63-02130	6001-	P-UB-14	70 mm	100 mm	KOM-707-98-37110	134.05
MODEL PC150LC-3							
ARM	21K-63-66500	3001-4384	P-U-14	80 mm	120 mm	KOM-707-98-45200	162.93
	21K-63-66501	4385-	P-U-14	80 mm	120 mm	KOM-707-98-45200	162.93
BOOM	21K-63-56500	3001-4207	P-U-14	75 mm	110 mm	KOM-707-98-38510	117.24
	21K-63-56501	4208-	P-U-14	75 mm	110 mm	KOM-707-98-38510	117.24
	21K-63-56600	3001-4207	P-U-14	75 mm	110 mm	KOM-707-98-38510	117.24
BUCKET	21K-63-56601	4208-	P-U-14	75 mm	110 mm	KOM-707-98-38510	117.24
	21K-63-76500	3001-3493	P-UB-14	70 mm	100 mm	KOM-707-98-37110	134.05
	21K-63-76501	3494-	P-UB-14	70 mm	100 mm	KOM-707-98-37130	109.88
MODEL PC200-1							
BOOM	205-63-55141		P-U-14	90 mm	130 mm	KOM-707-98-47500	162.13
BUCKET	205-63-75141		P-U-14	80 mm	130 mm	KOM-707-98-45700	185.32
MODEL PC200-2							
BUCKET	206-63-75141		P-U-14	80 mm	130 mm	KOM-707-98-45700	185.32
MODEL PC200-3, PC200LC-3							
ARM	205-63-62101	20001-35302	P-U-14	95 mm	130 mm	KOM-707-98-48600	197.31
	205-63-69300	35303-	P-UB-14	95 mm	130 mm	KOM-707-99-48610	277.38
BOOM	205-63-52100	20001-35302	P-U-14	85 mm	120 mm	KOM-707-98-46200	169.98
	205-63-52200	20001-35302	P-U-14	85 mm	120 mm	KOM-707-98-46200	169.98
BOOM (SLF)	205-63-59300	35303-	P-UB-14	85 mm	120 mm	KOM-707-98-46270	252.10
	205-63-59400	35303-	P-UB-14	85 mm	120 mm	KOM-707-98-46270	252.10
	206-63-52100	20001-35302	P-U-14	90 mm	130 mm	KOM-707-98-47600	194.34
	206-63-52200	20001-35302	P-U-14	90 mm	130 mm	KOM-707-98-47600	194.34
BUCKET	206-63-59300	35303-	P-UB-14	90 mm	130 mm	KOM-707-98-47620	230.02
	206-63-59400	35303-	P-UB-14	90 mm	130 mm	KOM-707-98-47620	230.02
BUCKET (1.8M ARM)	205-63-72100	20001-35302	P-U-14	75 mm	110 mm	KOM-707-98-38500	111.30
	205-63-79300	35303-	P-U-14	75 mm	110 mm	KOM-707-98-38500	111.30
BUCKET (SLF)	205-63-72301	20001-?	P-U-14	85 mm	120 mm	KOM-707-98-46100	137.70
	205-63-79700		P-UB-14	85 mm	120 mm	KOM-707-99-46210	225.45
	203-63-72500	20001-	P-UB-14	65 mm	100 mm	KOM-707-98-36110	78.84
MODEL PC200-5, PC200LC-5							
ARM	205-63-02120	45001-	P-UB-14	95 mm	135 mm	KOM-707-99-57200	300.38
BOOM	205-63-02100	45001-	P-UB-14	85 mm	120 mm	KOM-707-99-46600	267.55
BOOM (SLF)	206-63-02100	45001-	P-UB-14	90 mm	130 mm	KOM-707-99-47600	272.62
BUCKET	205-63-02130	45001-	P-UB-14	80 mm	115 mm	KOM-707-98-45220	208.57
BUCKET (HD)	206-63-02130	45001-	P-UB-14	90 mm	130 mm	KOM-707-98-47620	230.02
BUCKET (SLF)	203-63-02130	45001-	P-UB-14	65 mm	95 mm	KOM-707-98-36210	160.34
MODEL PC210-3, PC210LC-3							
ARM	205-63-62101	10001-	P-U-14	95 mm	130 mm	KOM-707-98-48600	197.31
BOOM LH	205-63-52100	10001-	P-U-14	85 mm	120 mm	KOM-707-98-46200	169.98
BOOM RH	205-63-52200	10001-	P-U-14	85 mm	120 mm	KOM-707-98-46200	169.98
BUCKET	205-63-72100	10001-	P-U-14	75 mm	110 mm	KOM-707-98-38500	111.30
MODEL PC210-6, PC210LC-6							
ARM	205-63-63340	A82001 & UP	P-UB-14	95 mm	135 mm	KOM-707-99-57200	300.38
	205-63-63340	A82001 & UP	P-UB-14	95 mm	135 mm	KOM-707-99-57200	300.38
BOOM	206-63-54141	A82001 & UP	P-UB-14	90 mm	130 mm	KOM-707-99-47600	272.62

Replacement Kits For

KOMATSU

KOMATSU

Excavators - Tracked							
APPLICATION	CYL #	SERIAL #	CODE	ROD	BORE	KIT #	List \$
MODEL PC210-6, PC210LC-6							
BOOM	206-63-54141	A82001 & UP	P-UB-14	90 mm	130 mm	KOM-707-99-47600	272.62
BUCKET	205-63-73340	A82001 & UP	P-UB-14	80 mm	115 mm	KOM-707-98-45220	208.57
	208-63-73340	A82001 & UP	P-UB-14	80 mm	115 mm	KOM-707-98-45220	208.57
BUCKET DEMOLITION SPEC	206-63-73340	A82001 & UP	P-UB-14	90 mm	130 mm	KOM-707-98-47620	230.02
	206-63-73340	A82001 & UP	P-UB-14	90 mm	130 mm	KOM-707-98-47620	230.02
MODEL PC220, PC220LC, PC220-2, PC220LC-2							
ARM	206-63-65101	11001-	P-U-14	100 mm	150 mm	KOM-PC-1	121.19
BOOM LH	206-63-55300	11001-	P-U-14	90 mm	140 mm	KOM-PC-2	109.75
BOOM RH	206-63-55400	11001-	P-U-14	90 mm	140 mm	KOM-PC-2	109.75
BUCKET	205-63-75101	11001-	P-U-14	80 mm	140 mm	KOM-PC-3	137.54
MODEL PC220-3, PC220LC-3							
ARM	206-63-62101	20001-23737	P-U-14	95 mm	140 mm	KOM-707-98-57201	100.11
ARM (SLF)	205-63-62101	2001-23614	P-U-14	95 mm	130 mm	KOM-707-98-48600	197.31
	205-63-69300	23615-	P-UB-14	95 mm	130 mm	KOM-707-99-48610	277.38
BOOM	206-63-52100	20001-23737	P-U-14	90 mm	130 mm	KOM-707-98-47600	194.34
	206-63-52200	20001-23737	P-U-14	90 mm	130 mm	KOM-707-98-47600	194.34
	206-63-59300	23738-	P-UB-14	90 mm	130 mm	KOM-707-98-47620	230.02
BUCKET	206-63-59400	23738-	P-UB-14	90 mm	130 mm	KOM-707-98-47620	230.02
	206-63-72100	20001-23737	P-U-14	90 mm	130 mm	KOM-707-98-47500	162.13
	206-63-79300	23738-	P-UB-14	90 mm	130 mm	KOM-707-99-47610	230.33
BUCKET (2M ARM)	206-63-72300	20001-	P-U-14	100 mm	140 mm	KOM-707-98-58230	109.38
BUCKET (SLF)	203-63-72500	20001-	P-UB-14	65 mm	100 mm	KOM-707-98-36110	78.84
MODEL PC220-5, PC220LC-5							
ARM	206-63-02120	35001-	P-UB-14	100 mm	140 mm	KOM-707-99-58200	307.12
ARM (SLF)	205-63-02120	35001-	P-UB-14	95 mm	135 mm	KOM-707-99-57200	300.38
BOOM	206-63-02100	35001-	P-UB-14	90 mm	130 mm	KOM-707-99-47600	272.62
BUCKET	206-63-02130	35001-	P-UB-14	90 mm	130 mm	KOM-707-98-47620	230.02
BUCKET (SLF)	203-63-02130	35001-	P-UB-14	65 mm	95 mm	KOM-707-98-36210	160.34
MODEL PC280LC-3							
ARM	206-63-62101	10001-	P-U-14	95 mm	140 mm	KOM-707-98-57201	100.11
ARM (SLF)	205-63-62101	10001-	P-U-14	95 mm	130 mm	KOM-707-98-48600	197.31
BOOM	206-63-52100	10001-	P-U-14	90 mm	130 mm	KOM-707-98-47600	194.34
	206-63-52200	10001-	P-U-14	90 mm	130 mm	KOM-707-98-47600	194.34
BUCKET	206-63-72100	10001-	P-U-14	90 mm	130 mm	KOM-707-98-47500	162.13
BUCKET (2M ARM)	206-63-72300	10001-	P-U-14	100 mm	140 mm	KOM-707-98-58230	109.38
BUCKET (SLF)	203-63-72500	10001-	P-UB-14	65 mm	100 mm	KOM-707-98-36110	78.84
CLAMSHELL	206-63-96101	10001-	P-U-14	90 mm	130 mm	KOM-707-98-47680	132.45
MODEL PC300-3, PC300LC-3							
ARM	207-63-62101	12001-	P-U-14	110 mm	160 mm	KOM-707-98-67100	278.19
BOOM	207-63-52100	12001-	P-U-14	100 mm	140 mm	KOM-707-98-58200	195.26
	207-63-52200	12001-	P-U-14	100 mm	140 mm	KOM-707-98-58200	195.26
	207-63-72101	12001-	P-U-14	100 mm	140 mm	KOM-707-98-58210	159.29
BUCKET	207-63-72101	12001-	P-U-14	100 mm	140 mm	KOM-707-98-58210	159.29
CLAMSHELL	206-63-96101	12001-	P-U-14	90 mm	130 mm	KOM-707-98-47680	132.45
WEIGHT REMOVER	208-63-07011	12001-	P-U-14	85 mm	130 mm	KOM-707-98-46600	160.76
MODEL PC300-5, PC300LC-5							
ARM	207-63-02120	20001-	P-UB-14	110 mm	160 mm	KOM-707-99-67110	381.70
BOOM	207-63-02100	20001-	P-UB-14	100 mm	140 mm	KOM-707-99-58210	341.69
BUCKET	207-63-02130	20001-	P-UB-14	100 mm	140 mm	KOM-707-99-58110	288.46

Replacement Kits For

KOMATSU

KOMATSU

Excavators - Tracked							
APPLICATION	CYL #	SERIAL #	CODE	ROD	BORE	KIT #	List \$
MODEL PC360LC-3							
ARM	207-63-62101	10001-	P-U-14	110 mm	160 mm	KOM-707-98-67100	278.19
BOOM	207-63-52100	10001-	P-U-14	100 mm	140 mm	KOM-707-98-58200	195.26
	207-63-52200	10001-	P-U-14	100 mm	140 mm	KOM-707-98-58200	195.26
BUCKET	207-63-72101	10001-	P-U-14	100 mm	140 mm	KOM-707-98-58210	159.29
CLAMSHELL	206-63-96101	10001-	P-U-14	90 mm	130 mm	KOM-707-98-47680	132.45
WEIGHT REMOVER	208-63-07011	10001-	P-U-14	85 mm	130 mm	KOM-707-98-46600	160.76
MODEL PC400-3, PC400LC-3							
ARM (B/H)	208-63-62101	11001-	P-U-14	120 mm	180 mm	KOM-707-98-68500	279.43
ARM (L/S)	208-63-64101	11001-	P-U-14	120 mm	180 mm	KOM-707-98-68400	253.52
BOOM (B/H)	208-63-52101	11001-	P-U-14	110 mm	160 mm	KOM-707-98-67100	278.19
	208-63-52201	11001-	P-U-14	110 mm	160 mm	KOM-707-98-67100	278.19
BOOM (L/S)	208-63-54103	11001-	P-U-14	110 mm	160 mm	KOM-707-98-67110	283.33
	208-63-54203	11001-	P-U-14	110 mm	160 mm	KOM-707-98-67110	283.33
BOTTOM DUMP	208-63-94100	11001-	P-U-14	95 mm	130 mm	KOM-707-98-48500	189.70
	208-63-94200	11001-	P-U-14	95 mm	130 mm	KOM-707-98-48500	189.70
BUCKET (B/H)	208-63-72101	11001-	P-U-14	120 mm	180 mm	KOM-707-98-68500	279.43
BUCKET (L/S)	208-63-74100	11001-	P-U-14	95 mm	130 mm	KOM-707-98-48510	200.21
	208-63-74200	11001-	P-U-14	95 mm	130 mm	KOM-707-98-48510	200.21
CLAMSHELL	208-63-92100	11001-	P-U-14	100 mm	140 mm	KOM-707-98-58230	109.38
WEIGHT REMOVER	208-63-07011	11001-	P-U-14	85 mm	130 mm	KOM-707-98-46600	160.76
MODEL PC400-5, PC400LC-5							
ARM	208-63-02120	20001-	P-UB-14	120 mm	185 mm	KOM-707-99-68510	390.29
BOOM	208-63-02100	20001-	P-UB-14	110 mm	160 mm	KOM-707-99-67120	377.02
BUCKET	208-63-02130	20001-	P-UB-14	110 mm	160 mm	KOM-707-99-67010	321.96
MODEL PC650-1							
BOTTOM DUMP	209-63-96103	10007-	P-UB-14	130 mm	180 mm	KOM-707-99-69600	296.27
PCOMPENSATION	209-63-86302	10007-	P-U-14	120 mm	200 mm	KOM-707-98-75020	196.94
	209-63-86402	10007-	P-U-14	120 mm	200 mm	KOM-707-98-75020	196.94
MODEL PC650-3							
ARM (B/H)	209-63-02031	10501-	P-UB-14	140 mm	200 mm	KOM-707-99-77240	511.04
BOOM (B/H)	209-63-02011	10501-	P-UB-14	140 mm	200 mm	KOM-707-99-77240	511.04
BUCKET (B/H)	209-63-02040	10501-10632	P-UB-14	130 mm	180 mm	KOM-707-99-69600	296.27
	209-63-02042		P-UB-14	130 mm	180 mm	KOM-707-99-69600	296.27
BUCKET (L/S)	209-63-03041	10501-	P-UB-14	130 mm	180 mm	KOM-707-99-69600	296.27
MODEL PC1000-1							
ARM (B/H)	21N-63-02030	10001-	P-UB-14	170 mm	250 mm	KOM-707-99-89200	602.41
ARM (L/S)	21N-63-03030	10001-	P-UB-14	130 mm	180 mm	KOM-707-99-69620	313.30
BOOM (B/H)	21N-63-02010	10001-	P-UB-14	160 mm	225 mm	KOM-707-99-78620	785.71
BOOM (L/S)	21N-63-03010	10001-	P-UB-14	160 mm	225 mm	KOM-707-99-78620	785.71
BOTTOM DUMP	21N-63-03071	10001-	P-UB-14	90 mm	140 mm	KOM-707-99-56310	256.50
BUCKET (B/H)	21N-63-02040	10001-	P-UB-14	160 mm	225 mm	KOM-707-99-78630	785.47
BUCKET (L/S)	21N-63-03050	10001-	P-UB-14	140 mm	200 mm	KOM-707-99-77250	463.57
MODEL PC1000SE-1							
ARM	21N-63-02030	10001-	P-UB-14	170 mm	250 mm	KOM-707-99-89200	602.41
BOOM	21N-63-02010	10001-	P-UB-14	160 mm	225 mm	KOM-707-99-78620	785.71
BUCKET	21N-63-02060	10001-	P-UB-14	160 mm	225 mm	KOM-707-99-78630	785.47

Replacement Kits For

KOMATSU

Excavators - Wheeled							
APPLICATION	CYL #	SERIAL #	CODE	ROD	BORE	KIT #	List \$
MODEL PW20-1							
ARM	20R-63-66300	1001-	P-U-14	40 mm	80 mm	KOM-707-98-22040	77.67
BLADE	21E-63-02010	1001-	P-U-14	45 mm	90 mm	KOM-707-98-24430	95.72
BOOM	20R-63-56500	1001-	P-U-14	40 mm	80 mm	KOM-707-98-22110	77.60
BOOM SWING	20S-63-86301	1001-	P-U-14	35 mm	70 mm	KOM-707-98-12440	51.51
BUCKET	20R-63-76301	1001-	P-U-14	35 mm	70 mm	KOM-707-98-12440	51.51
MODEL PW30-1							
ARM	20R-63-66300	1001-	P-U-14	40 mm	80 mm	KOM-707-98-22040	77.67
BLADE	21E-63-02010	1001-	P-U-14	45 mm	90 mm	KOM-707-98-24430	95.72
BOOM	20R-63-56500	1001-	P-U-14	40 mm	80 mm	KOM-707-98-22110	77.60
BOOM SWING	20S-63-86301	1001-	P-U-14	35 mm	70 mm	KOM-707-98-12440	51.51
BUCKET	20S-63-76102	1001-	P-U-14	40 mm	70 mm	KOM-707-98-14600	60.41
MODEL PW60-3							
BLADE	20B-63-02060	2001-	P-U-14	45 mm	70 mm	KOM-707-98-15720	88.61
BOOM	201-63-02010	2001-	P-U-14	65 mm	100 mm	KOM-707-99-36260	125.58
OUTRIGGER	20B-63-02020	2001-	P-U-14	45 mm	70 mm	KOM-707-98-15700	63.20
MODEL PW100-1							
ARM	202-63-62100	1003-	P-U-14	70 mm	120 mm	KOM-707-98-43100	155.69
BLADE	20D-63-96300	1003-	P-U-14	50 mm	90 mm	KOM-707-98-25510	111.79
	20D-63-96400	1003-	P-U-14	50 mm	90 mm	KOM-707-98-25510	111.79
BOOM	202-63-52100	1003-	P-U-14	65 mm	110 mm	KOM-707-98-36510	113.16
	202-63-52200	1003-	P-U-14	65 mm	110 mm	KOM-707-98-36510	113.16
BUCKET	202-63-72100	1003-	P-U-14	65 mm	110 mm	KOM-707-98-36520	83.78
OUTRIGGER	20D-63-12700	1003-	P-U-14	65 mm	110 mm	KOM-707-98-36500	98.38
	20D-63-12800	1003-	P-U-14	65 mm	110 mm	KOM-707-98-36500	98.38
STEERING	20D-63-22301	1003-	P-U-14	30 mm	60 mm	KOM-707-99-11030	52.55
MODEL PW100-3							
OUTRIGGER	20G-63-12101	1601-	P-U-14	70 mm	110 mm	KOM-707-98-37500	114.77
	20G-63-12201	1601-	P-U-14	70 mm	110 mm	KOM-707-98-37500	114.77
MODEL PW100N-3							
ARM	202-63-62500	1601-1667	P-U-14	75 mm	110 mm	KOM-707-98-38600	124.10
	202-63-62502	1668-2300	P-U-14	75 mm	110 mm	KOM-707-98-38600	124.10
	20D-63-02030	2301-	P-U-14	75 mm	110 mm	KOM-707-98-38600	124.10
BOOM	202-63-52500	1601-2300	P-UB-14	65 mm	100 mm	KOM-707-98-36100	105.36
	202-63-52600	1601-2300	P-UB-14	65 mm	100 mm	KOM-707-98-36100	105.36
	20D-63-02010	2301-	P-UB-14	65 mm	100 mm	KOM-707-98-36100	105.36
BUCKET	202-63-72500	1601-1667	P-UB-14	65 mm	100 mm	KOM-707-98-36110	78.84
	202-63-72501	1668-2300	P-UB-14	65 mm	100 mm	KOM-707-98-36110	78.84
	20D-63-02040	2301-	P-UB-14	65 mm	100 mm	KOM-707-98-36110	78.84
OUTRIGGER	20D-63-13100	1601-	P-U-14	65 mm	110 mm	KOM-707-98-36560	98.32
	20D-63-13200	1601-	P-U-14	65 mm	110 mm	KOM-707-98-36560	98.32
MODEL PW150-1							
ARM	20G-63-62100	1001-	P-U-14	90 mm	130 mm	KOM-707-98-47510	187.47
ARM (LOCK VALVE)	20G-63-62141	1001-	P-U-14	90 mm	130 mm	KOM-707-98-47510	187.47
BLADE	20G-63-92110	1001-	P-U-14	70 mm	110 mm	KOM-707-98-37500	114.77
OUTRIGGER	20G-63-12100	1001-1283	P-U-14	70 mm	110 mm	KOM-707-98-37500	114.77
	20G-63-12101	1284-	P-U-14	70 mm	110 mm	KOM-707-98-37500	114.77
	20G-63-12200	1001-1283	P-U-14	70 mm	110 mm	KOM-707-98-37500	114.77
	20G-63-12201	1284-	P-U-14	70 mm	110 mm	KOM-707-98-37500	114.77

Replacement Kits For

KOMATSU

KOMATSU

Excavators - Wheeled							
APPLICATION	CYL #	SERIAL #	CODE	ROD	BORE	KIT #	List \$
MODEL PW150-1							
SUSPENSION LOCK	20G-63-32100	1001-	P-U-14	70 mm	110 mm	KOM-707-98-37500	114.77
MODEL PW210-1							
ARM	205-63-62101	10001-	P-U-14	95 mm	130 mm	KOM-707-98-48600	197.31
BOOM	205-63-52100	10001-	P-U-14	85 mm	120 mm	KOM-707-98-46200	169.98
	205-63-52200	10001-	P-U-14	85 mm	120 mm	KOM-707-98-46200	169.98
BUCKET	205-63-72100	10001-	P-U-14	75 mm	110 mm	KOM-707-98-38500	111.30
BUCKET (1.8M)	205-63-72301	10001-	P-U-14	85 mm	120 mm	KOM-707-98-46100	137.70
OUTRIGGER	20K-63-02010	10001-	P-U-14	80 mm	130 mm	KOM-707-98-45700	185.32
STEERING	20K-63-02030	10001-	P-U-14	40 mm	90 mm	KOM-707-98-22430	69.57
SUSPENSION LOCK	20G-63-32100	10001-	P-U-14	70 mm	110 mm	KOM-707-98-37500	114.77
Motor Graders							
APPLICATION	CYL #	SERIAL #	CODE	ROD	BORE	KIT #	List \$
MODEL GD200A-1							
SCARIFIER	237-63-32500	2001-	P-U-14	40 mm	80 mm	KOM-707-98-22120	77.67
MODEL GD300A-1							
ARTICULATE	237-63-62501	2001-	P-U-14	60 mm	120 mm	KOM-707-98-41030	137.21
BLADE LIFT	237-63-12500	2001-	P-U-14	35 mm	70 mm	KOM-707-98-12550	51.63
BLADE SHIFT	237-63-42500	2001-	P-U-14	40 mm	60 mm	KOM-707-98-14240	61.84
FRONT BLADE	237-63-32500	2001-	P-U-14	40 mm	80 mm	KOM-707-98-22120	77.67
SCARIFIER	237-63-32500	2001-	P-U-14	40 mm	80 mm	KOM-707-98-22120	77.67
MODEL GD405A-1							
ARTICULATE	233-63-62300	50002-50610	P-U-14	50 mm	90 mm	KOM-707-98-25500	100.80
	233-63-62500	50611-	P-U-14	50 mm	90 mm	KOM-707-98-25430	93.18
BLADE LIFT	233-63-12300	50002-50610	P-U-14	40 mm	70 mm	KOM-707-98-14700	60.41
BLADE SHIFT	233-63-42300	50002-50610	P-U-14	40 mm	70 mm	KOM-707-98-14600	60.41
DRAWBAR SHIFT	233-63-22300	50002-50610	P-U-14	40 mm	70 mm	KOM-707-98-14700	60.41
LEANING	233-63-52300	50002-50610	P-U-14	35 mm	70 mm	KOM-707-98-12600	51.69
POWER TILT	233-63-18300	50002-	P-U-14	40 mm	80 mm	KOM-707-98-22100	77.60
SCARIFIER	238-63-32100	50002-50610	P-U-14	50 mm	80 mm	KOM-707-98-25170	113.16
MODEL GD500R-2							
BLADE LIFT	238-63-12100	11002-	P-U-14	50 mm	80 mm	KOM-707-98-25070	84.10
BLADE SHIFT	238-63-42100	11002-	P-U-14	50 mm	80 mm	KOM-707-98-25170	113.16
DRAWBAR SHIFT	238-63-22100	11002-	P-U-14	50 mm	80 mm	KOM-707-98-25070	84.10
FRONT BLADE	232-63-33300	11002-	P-U-5	50 mm	80 mm	KOM-707-98-25060	109.75
LEANING	238-63-52100	11002-	P-U-14	35 mm	70 mm	KOM-707-98-12600	51.69
POWER TILT	238-63-18101	11002-	P-U-14	40 mm	80 mm	KOM-707-98-22100	77.60
SCARIFIER	238-63-32100	11002-	P-U-14	50 mm	80 mm	KOM-707-98-25170	113.16
MODEL GD505A-2							
ARTICULATE	233-63-62300	50003-	P-U-14	50 mm	90 mm	KOM-707-98-25500	100.80
BLADE LIFT	238-63-12100	50003-	P-U-14	50 mm	80 mm	KOM-707-98-25070	84.10
BLADE SHIFT	238-63-42100	50003-	P-U-14	50 mm	80 mm	KOM-707-98-25170	113.16
DRAWBAR SHIFT	238-63-22100	50003-	P-U-14	50 mm	80 mm	KOM-707-98-25070	84.10
FRONT BLADE	232-63-33300	50003-	P-U-5	50 mm	80 mm	KOM-707-98-25060	109.75
LEANING	238-63-52100	50003-	P-U-14	35 mm	70 mm	KOM-707-98-12600	51.69
POWER TILT	238-63-18101	50003-	P-U-14	40 mm	80 mm	KOM-707-98-22100	77.60
SCARIFIER	238-63-32100	50003-	P-U-14	50 mm	80 mm	KOM-707-98-25170	113.16
MODEL GD505R-2							
BLADE LIFT	238-63-12100	30002-	P-U-14	50 mm	80 mm	KOM-707-98-25070	84.10

Replacement Kits For

KOMATSU

Motor Graders							
APPLICATION	CYL #	SERIAL #	CODE	ROD	BORE	KIT #	List \$
MODEL GD505R-2							
BLADE SHIFT	238-63-42100	30002-	P-U-14	50 mm	80 mm	KOM-707-98-25170	113.16
DRAWBAR SHIFT	238-63-22100	30002-	P-U-14	50 mm	80 mm	KOM-707-98-25070	84.10
FRONT BLADE	232-63-33300	30002-	P-U-5	50 mm	80 mm	KOM-707-98-25060	109.75
LEANING	238-63-52100	30002-	P-U-14	35 mm	70 mm	KOM-707-98-12600	51.69
POWER TILT	238-63-18101	30002-	P-U-14	40 mm	80 mm	KOM-707-98-22100	77.60
SCARIFIER	238-63-32100	30002-	P-U-14	50 mm	80 mm	KOM-707-98-25170	113.16
MODEL GD510R-1							
LEANING	23A-63-52101	15001-	P-U-14	35 mm	70 mm	KOM-707-98-12470	55.16
MODEL GD511A-1, GD513A-1							
LEANING	23A-63-52101	10001-	P-U-14	35 mm	70 mm	KOM-707-98-12470	55.16
MODEL GD513R-1							
LEANING	23A-63-52101	30001-	P-U-14	35 mm	70 mm	KOM-707-98-12470	55.16
MODEL GD515A-1							
LEANING	23A-63-52101	50001-	P-U-14	35 mm	70 mm	KOM-707-98-12470	55.16
MODEL GD521A-1, GD521R-1							
BLADE LIFT	238-63-12301	10001-	P-U-14	50 mm	80 mm	KOM-707-98-25030	82.55
BLADE SHIFT	23B-63-42300	10001-	P-U-14	50 mm	80 mm	KOM-707-98-25040	111.09
DRAWBAR SHIFT	23B-63-22102	10001-	P-U-14	45mm	80mm	KOM-707-98-24040	78.84
FRONT BLADE	232-63-38100	10001-	P-U-14	45 mm	90 mm	KOM-707-98-24430	95.72
LEANING	23A-63-52102	10001-	P-U-14	35 mm	70 mm	KOM-707-98-12470	55.16
MODEL GD523A-1, GD523R-1							
BLADE LIFT	238-63-12301	30001-	P-U-14	50 mm	80 mm	KOM-707-98-25030	82.55
BLADE SHIFT	23B-63-42300	30001-	P-U-14	50 mm	80 mm	KOM-707-98-25040	111.09
DRAWBAR SHIFT	23B-63-22102	30001-	P-U-14	45mm	80mm	KOM-707-98-24040	78.84
FRONT BLADE	232-63-38100	30001-	P-U-14	45 mm	90 mm	KOM-707-98-24430	95.72
LEANING	23A-63-52102	30001-	P-U-14	35 mm	70 mm	KOM-707-98-12470	55.16
MODEL GD525A-1							
BLADE LIFT	238-63-12301	50001-	P-U-14	50 mm	80 mm	KOM-707-98-25030	82.55
BLADE SHIFT	23B-63-42301	50001-	P-U-14	50 mm	80 mm	KOM-707-98-25040	111.09
DRAWBAR SHIFT	23B-63-22102	50001-	P-U-14	45mm	80mm	KOM-707-98-24040	78.84
LEANING	23A-63-52102	50001-	P-U-14	35 mm	70 mm	KOM-707-98-12470	55.16
MODEL GD600R-3							
BLADE LIFT	238-63-12100	14001-	P-U-14	50 mm	80 mm	KOM-707-98-25070	84.10
DRAWBAR SHIFT	238-63-22100	14001-	P-U-14	50 mm	80 mm	KOM-707-98-25070	84.10
FRONT BLADE	232-63-33300	14001-	P-U-5	50 mm	80 mm	KOM-707-98-25060	109.75
POWER TILT	238-63-18101	14001-	P-U-14	40 mm	80 mm	KOM-707-98-22100	77.60
RIPPER	232-63-25101	14001-	P-U-5	50 mm	120 mm	KOM-707-99-40100	128.98
STEERING	232-63-76101	14001-	P-U-14	35 mm	60 mm	KOM-707-98-12200	52.99
MODEL GD605A-3							
ARTICULATE	233-63-62300	54001-	P-U-14	50 mm	90 mm	KOM-707-98-25500	100.80
BLADE LIFT	238-63-12100	54001-	P-U-14	50 mm	80 mm	KOM-707-98-25070	84.10
DRAWBAR SHIFT	238-63-22100	54001-	P-U-14	50 mm	80 mm	KOM-707-98-25070	84.10
FRONT BLADE	232-63-33300	54001-	P-U-5	50 mm	80 mm	KOM-707-98-25060	109.75
POWER TILT	238-63-18101	54001-	P-U-14	40 mm	80 mm	KOM-707-98-22100	77.60
RIPPER	232-63-25101	54001-	P-U-5	50 mm	120 mm	KOM-707-99-40100	128.98
STEERING	232-63-76101	54001-	P-U-14	35 mm	60 mm	KOM-707-98-12200	52.99
MODEL GD611A-1, GD611R-1							
ARTICULATE	23B-63-62101	10001-	P-U-14	50 mm	90 mm	KOM-707-98-25430	93.18

Replacement Kits For

KOMATSU

KOMATSU

Motor Graders							
APPLICATION	CYL #	SERIAL #	CODE	ROD	BORE	KIT #	List \$
MODEL GD611A-1, GD611R-1							
BLADE LIFT	238-63-12301	10001-	P-U-14	50 mm	80 mm	KOM-707-98-25030	82.55
DRAWBAR SHIFT	23B-63-22102	10001-	P-U-14	45mm	80mm	KOM-707-98-24040	78.84
FRONT BLADE	232-63-38100	10001-	P-U-14	45 mm	90 mm	KOM-707-98-24430	95.72
MODEL GD613A-1, GD613R-1							
ARTICULATE	23B-63-62101	30001-	P-U-14	50 mm	90 mm	KOM-707-98-25430	93.18
BLADE LIFT	238-63-12301	30001-	P-U-14	50 mm	80 mm	KOM-707-98-25030	82.55
DRAWBAR SHIFT	23B-63-22100	30001-	P-U-14	45mm	80mm	KOM-707-98-24040	78.84
MODEL GD615A-1							
ARTICULATE	23B-63-62101	50001-	P-U-14	50 mm	90 mm	KOM-707-98-25430	93.18
BLADE LIFT	238-63-12301	50001-	P-U-14	50 mm	80 mm	KOM-707-98-25030	82.55
BLADE SHIFT	23B-63-42301	50001-	P-U-14	50 mm	80 mm	KOM-707-98-25040	111.09
DRAWBAR SHIFT	23B-63-22102	50001-	P-U-14	45mm	80mm	KOM-707-98-24040	78.84
MODEL GD621A-1, GD621R-1							
ARTICULATE	23B-63-62101	10001-	P-U-14	50 mm	90 mm	KOM-707-98-25430	93.18
BLADE LIFT	238-63-12301	10001-	P-U-14	50 mm	80 mm	KOM-707-98-25030	82.55
BLADE SHIFT	23B-63-42300	10001-	P-U-14	50 mm	80 mm	KOM-707-98-25040	111.09
DRAWBAR SHIFT	23B-63-22102	10001-	P-U-14	45mm	80mm	KOM-707-98-24040	78.84
FRONT BLADE	232-63-38100	10001-	P-U-14	45 mm	90 mm	KOM-707-98-24430	95.72
MODEL GD623A-1, GD623R-1, GD663A-1							
ARTICULATE	23B-63-62101	30001-	P-U-14	50 mm	90 mm	KOM-707-98-25430	93.18
BLADE LIFT	238-63-12301	30001-	P-U-14	50 mm	80 mm	KOM-707-98-25030	82.55
DRAWBAR SHIFT	23B-63-22100	30001-	P-U-14	45mm	80mm	KOM-707-98-24040	78.84
FRONT BLADE	232-63-38100	30001-	P-U-14	45 mm	90 mm	KOM-707-98-24430	95.72
SCARIFIER	23B-63-32102	30001-	P-U-14	50 mm	90 mm	KOM-707-98-25430	93.18
MODEL GD625A-1							
ARTICULATE	23B-63-62101	50001-	P-U-14	50 mm	90 mm	KOM-707-98-25430	93.18
BLADE SHIFT	23B-63-42301	50001-	P-U-14	50 mm	80 mm	KOM-707-98-25040	111.09
DRAWBAR SHIFT	23B-63-22102	50001-	P-U-14	45mm	80mm	KOM-707-98-24040	78.84
SCARIFIER	23B-63-32102	50001-	P-U-14	50 mm	90 mm	KOM-707-98-25430	93.18
MODEL GD705A-3							
BLADE LIFT	234-63-13001	10002-	P-U-5	55 mm	90 mm	KOM-707-98-26600	93.93
DRAWBAR SHIFT	234-63-23000	10002-	P-U-5	55 mm	90 mm	KOM-707-98-26600	93.93
LEANING	234-63-53002	10002-	P-U-14	45 mm	90 mm	KOM-707-98-24530	103.70
POWER TILT	234-63-28001	10002-	P-U-14	50 mm	100 mm	KOM-707-99-33010	85.15
RIPPER	234-63-25000	10002-	P-U-14	70 mm	140 mm	KOM-707-98-52100	178.76
MODEL GD705A-4							
BLADE LIFT	234-63-13001	31001-	P-U-5	55 mm	90 mm	KOM-707-98-26600	93.93
DRAWBAR SHIFT	234-63-23001	31001-	P-U-5	55 mm	90 mm	KOM-707-98-26600	93.93
LEANING	234-63-53002	31001-	P-U-14	45 mm	90 mm	KOM-707-98-24530	103.70
POWER TILT	234-63-28100	31001-	P-U-14	50 mm	100 mm	KOM-707-99-32010	96.77
RIPPER	234-63-25001	31001-	P-U-14	70 mm	140 mm	KOM-707-98-52100	178.76
MODEL GD825A-1							
ARTICULATE	235-63-63000	10002-	P-U-14	65 mm	120 mm	KOM-707-98-41110	146.29
BLADE LIFT	235-63-16100	10002-	P-U-14	65 mm	100 mm	KOM-707-98-36230	86.07
DRAWBAR SHIFT	235-63-22000	10002-	P-U-14	60 mm	100 mm	KOM-707-98-35110	88.30
LEANING	235-63-53100	10002-	P-U-14	45 mm	90 mm	KOM-707-98-24500	71.17
POWER TILT	235-63-28000	10002-	P-U-14	65 mm	120 mm	KOM-707-98-42100	111.73
RIPPER	235-63-25200	10002-	P-U-14	70 mm	140 mm	KOM-707-98-52100	178.76

Replacement Kits For

KOMATSU

Motor Graders							
APPLICATION	CYL #	SERIAL #	CODE	ROD	BORE	KIT #	List \$
MODEL GD825A-1							
STEERING	235-63-76301	10002-10043	P-U-14	40 mm	60 mm	KOM-707-98-14030	61.84
	235-63-76303	10044-	P-U-14	40 mm	60 mm	KOM-707-98-14030	61.84
Wheel Loaders							
APPLICATION	CYL #	SERIAL #	CODE	ROD	BORE	KIT #	List \$
MODEL WA30-1							
DUMP	362-63-22101	1001-	P-U-14	35 mm	60 mm	KOM-707-98-12110	54.10
LIFT	362-63-12100	1001-	P-U-14	35 mm	60 mm	KOM-707-98-12100	52.99
	362-63-12200	1001-	P-U-14	35 mm	60 mm	KOM-707-98-12100	52.99
STEERING	362-63-52101	1001-	P-U-14	30 mm	60 mm	KOM-707-99-11040	52.55
MODEL WA30-2							
DUMP	362-63-22101	3001-4101	P-U-14	35 mm	60 mm	KOM-707-98-12110	54.10
LIFT	362-63-12100	3001-4101	P-U-14	35 mm	60 mm	KOM-707-98-12100	52.99
	362-63-12200	3001-4101	P-U-14	35 mm	60 mm	KOM-707-98-12100	52.99
STEERING	362-63-52101	3001-4101	P-U-14	30 mm	60 mm	KOM-707-99-11040	52.55
MODEL WA70-1							
DUMP	707-00-01200	12001-	P-U-14	40 mm	80 mm	KOM-707-99-22100	104.75
	707-00-80041	10001-11999	P-U-14	40 mm	80 mm	KOM-707-99-22100	104.75
DUMP (HI-LIFT)	707-00-80540	10001-11999	P-U-14	40 mm	80 mm	KOM-707-99-22100	104.75
MODEL WA100-1							
CLAM	707-00-90010	10001-	P-U-14	50 mm	90 mm	KOM-707-99-25520	101.09
DUMP	707-00-10031	10001-	P-U-14	50 mm	100 mm	KOM-707-99-32100	82.58
DUMP (HI-LIFT)	707-00-10400	10001-	P-U-14	50 mm	100 mm	KOM-707-99-32100	82.58
DUMP (L BUCKET)	707-00-11210	10001-	P-U-14	55 mm	110 mm	KOM-707-99-34500	70.56
DUMP (LB HI-LIFT)	707-00-11220	10001-	P-U-14	55 mm	110 mm	KOM-707-99-34500	70.56
DUMP (S HI-LIFT)	707-00-11230	10001-	P-U-14	55 mm	110 mm	KOM-707-99-34500	70.56
GRAPPLE	707-00-80330	10001-	P-U-14	40 mm	80 mm	KOM-707-99-22100	104.75
LIFT	707-00-10011	10001-	P-U-14	55 mm	100 mm	KOM-707-99-34100	71.23
	707-00-10021	10001-	P-U-14	55 mm	100 mm	KOM-707-99-34100	71.23
STEERING	707-00-60011	10001-19999	P-U-14	40 mm	60 mm	KOM-707-99-14200	60.66
	707-00-60012	20001-	P-U-14	40 mm	60 mm	KOM-707-99-14200	60.66
	707-00-60021	10001-19999	P-U-14	40 mm	60 mm	KOM-707-99-14200	60.66
	707-00-60022	20001-	P-U-14	40 mm	60 mm	KOM-707-99-14200	60.66
MODEL WA120-1							
DUMP	707-00-12140	10001-	P-U-14	60 mm	120 mm	KOM-707-99-41100	103.57
LIFT	707-00-11320	10001-	P-U-14	70 mm	110 mm	KOM-707-99-37500	77.80
	707-00-11330	10001-	P-U-14	70 mm	110 mm	KOM-707-99-37500	77.80
STEERING	707-00-60012	10001-	P-U-14	40 mm	60 mm	KOM-707-99-14200	60.66
	707-00-60022	10001-	P-U-14	40 mm	60 mm	KOM-707-99-14200	60.66
MODEL WA150-1							
CLAM	707-0090010	10001-	P-U-14	50 mm	90 mm	KOM-707-99-25520	101.09
DUMP	707-00-12022	10001-	P-U-14	60 mm	120 mm	KOM-707-99-41100	103.57
DUMP (HI-LIFT)	707-00-12300	10001-	P-U-14	60 mm	120 mm	KOM-707-99-41100	103.57
GRAPPLE	707-00-80330	10001-	P-U-14	40 mm	80 mm	KOM-707-99-22100	104.75
LIFT	707-00-11031	10001-	P-U-14	70 mm	110 mm	KOM-707-99-37500	77.80
	707-00-11041	10001-	P-U-14	70 mm	110 mm	KOM-707-99-37500	77.80
STEERING	707-00-60011	10001-19999	P-U-14	40 mm	60 mm	KOM-707-99-14200	60.66
	707-00-60012	20001-	P-U-14	40 mm	60 mm	KOM-707-99-14200	60.66
	707-00-60021	10001-19999	P-U-14	40 mm	60 mm	KOM-707-99-14200	60.66

Replacement Kits For

KOMATSU

KOMATSU

Wheel Loaders							
APPLICATION	CYL #	SERIAL #	CODE	ROD	BORE	KIT #	List \$
MODEL WA150-1							
STEERING	707-00-60022	20001-	P-U-14	40 mm	60 mm	KOM-707-99-14200	60.66
MODEL WA180-1							
CLAM	707-00-90010	10001-	P-U-14	50 mm	90 mm	KOM-707-99-25520	101.09
DUMP	707-01-13190	10001-	P-U-14	70 mm	130 mm	KOM-707-99-43500	128.00
	707-01-13510	10001-	P-U-14	70 mm	130 mm	KOM-707-99-43500	128.00
LIFT	707-00-12080	10001-10088	P-U-14	70 mm	120 mm	KOM-707-99-43100	125.27
	707-00-12081	10089-	P-U-14	70 mm	120 mm	KOM-707-99-43100	125.27
STEERING	707-00-70410	10001-	P-U-14	45 mm	70 mm	KOM-707-99-15600	88.36
	707-00-70420	10001-	P-U-14	45 mm	70 mm	KOM-707-99-15600	88.36
MODEL WA200-1							
CLAM	707-00-10080	10001-	P-U-14	50 mm	100 mm	KOM-707-99-32100	82.58
DUMP	707-00-13011	10001-	P-U-14	70 mm	130 mm	KOM-707-99-43500	128.00
DUMP (HI-LIFT)	707-01-13020	10001-	P-U-14	70 mm	130 mm	KOM-707-99-43500	128.00
GRAPPLE	707-00-80330	10001-	P-U-14	40 mm	80 mm	KOM-707-99-22100	104.75
LIFT	707-00-12011	10001-29999	P-U-14	70 mm	120 mm	KOM-707-99-43100	125.27
STEERING	707-00-70131	10001-19999	P-U-14	40 mm	70 mm	KOM-707-99-14600	87.99
	707-00-70132	20001-29999	P-U-14	40 mm	70 mm	KOM-707-99-14600	87.99
MODEL WA250-1							
DUMP	707-01-15030	10001-	P-U-14	75 mm	150 mm	KOM-707-99-53500	143.74
LIFT	707-01-13520	10001-	P-U-14	70 mm	130 mm	KOM-707-99-43500	128.00
STEERING	707-00-01350	10629-	P-U-14	40 mm	70 mm	KOM-707-99-14610	50.95
	707-00-70131	10001-10628	P-U-14	40 mm	70 mm	KOM-707-99-14600	87.99
MODEL WA300-1							
CLAM	707-00-12040	10001-29999	P-U-14	60 mm	120 mm	KOM-707-99-41140	145.25
DUMP	707-01-16151	10001-29999	P-U-14	80 mm	160 mm	KOM-707-99-62010	131.58
GRAPPLE	707-00-10040	10001-29999	P-U-14	50 mm	100 mm	KOM-707-99-32100	82.58
LIFT	707-01-14131	10001-29999	P-U-14	80 mm	140 mm	KOM-707-99-54100	112.41
STEERING	707-00-70131	10001-29999	P-U-14	40 mm	70 mm	KOM-707-99-14600	87.99
MODEL WA320-1							
DUMP	707-01-03710	20001-	P-U-14	80 mm	160 mm	KOM-707-99-62020	125.22
	707-01-16151	10001-19999	P-U-14	80 mm	160 mm	KOM-707-99-62010	131.58
LIFT	707-01-03510	20001-	P-U-14	80 mm	140 mm	KOM-707-99-54100	112.41
	707-01-14131	10001-19999	P-U-14	80 mm	140 mm	KOM-707-99-54100	112.41
STEERING	707-00-01380	20001-	P-U-14	40 mm	70 mm	KOM-707-99-14610	50.95
	707-00-70131	10001-19999	P-U-14	40 mm	70 mm	KOM-707-99-14600	87.99
MODEL WA350-1							
CLAM	707-00-12030	10001-	P-U-14	60 mm	120 mm	KOM-707-99-41140	145.25
DUMP	707-01-03700	20001-	P-U-14	90 mm	180 mm	KOM-707-99-64410	133.45
	707-01-18081	10001-19999	P-U-14	90 mm	180 mm	KOM-707-99-64400	194.02
GRAPPLE	707-00-10040	10001-	P-U-14	50 mm	100 mm	KOM-707-99-32100	82.58
LIFT	707-01-03500	20001-	P-U-14	85 mm	150 mm	KOM-707-99-55500	119.84
	707-01-15071	10001-19999	P-U-14	90 mm	150 mm	KOM-707-99-56500	151.18
STEERING	707-00-01800	20001-	P-U-14	45 mm	80 mm	KOM-707-99-24120	72.04
	707-00-80021	10001-19999	P-U-14	45 mm	80 mm	KOM-707-99-24110	74.39
MODEL WA380-1							
DUMP	707-01-03700	20001-	P-U-14	90 mm	180 mm	KOM-707-99-64400	194.02
	707-01-18082	10001-19999	P-U-14	90 mm	180 mm	KOM-707-99-64400	194.02
LIFT	707-01-01080	20001-	P-U-14	90 mm	150 mm	KOM-707-99-64010	128.48

Replacement Kits For

KOMATSU

Wheel Loaders							
APPLICATION	CYL #	SERIAL #	CODE	ROD	BORE	KIT #	List \$
MODEL WA380-1							
LIFT	707-01-16280	10001-19999	P-U-14	90 mm	150 mm	KOM-707-99-64010	128.48
STEERING	707-00-01800	20001-	P-U-14	45 mm	80 mm	KOM-707-99-24120	72.04
	707-00-80021	10001-19999	P-U-14	45 mm	80 mm	KOM-707-99-24110	74.39
MODEL WA400-1							
DUMP	707-01-03271	20001-	P-U-14	100 mm	200 mm	KOM-707-99-73020	303.63
	707-01-20081	10001-19999	P-U-14	100 mm	200 mm	KOM-707-99-73010	303.63
LIFT	707-01-01070	20001-	P-U-14	90 mm	150 mm	KOM-707-99-64010	128.48
	707-01-16081	10001-19999	P-U-14	100 mm	160 mm	KOM-707-99-66010	132.20
LOG GRAPPLE	707-01-13260	10001-19999	P-U-14	70 mm	130 mm	KOM-707-99-43540	168.31
LUMBER GRAPPLE	707-00-10040	10001-19999	P-U-14	50 mm	100 mm	KOM-707-99-32100	82.58
STEERING	707-00-90221	10001-19999	P-U-14	45 mm	90 mm	KOM-707-99-24500	80.03
MODEL WA420-1							
DUMP	707-01-01270	20001-	P-U-14	100 mm	200 mm	KOM-707-99-73010	303.63
	707-01-20083	10001-19999	P-U-14	100 mm	200 mm	KOM-707-99-73010	303.63
LIFT	707-01-01070	20001-	P-U-14	90 mm	150 mm	KOM-707-99-64010	128.48
	707-01-16081	10001-19999	P-U-14	100 mm	160 mm	KOM-707-99-66010	132.20
STEERING	707-00-90221	10001-19999	P-U-14	45 mm	90 mm	KOM-707-99-24500	80.03
MODEL WA450-1, WA470-1							
DUMP	707-01-03250	20001-	P-U-14	100 mm	200 mm	KOM-707-99-73020	303.63
	707-01-20121	10001-19999	P-U-14	100 mm	200 mm	KOM-707-99-73010	303.63
GRAPPLE	707-01-13260	10001-19999	P-U-14	70 mm	130 mm	KOM-707-99-43540	168.31
LIFT	707-01-03050	20001-	P-U-14	95 mm	180 mm	KOM-707-99-65400	138.01
	707-01-18121	10001-19999	P-U-14	100 mm	180 mm	KOM-707-99-66400	279.36
STEERING	707-00-01840	20001-	P-U-14	50 mm	100 mm	KOM-707-99-32110	69.07
	707-00-01940	20001-	P-U-14	50 mm	100 mm	KOM-707-99-32110	69.07
	707-00-10211	10001-19999	P-U-14	50 mm	100 mm	KOM-707-99-32100	82.58
	707-00-10231	10001-19999	P-U-14	50 mm	100 mm	KOM-707-99-32100	82.58
MODEL WA500-1							
DUMP	707-01-22014	10001-	P-U-14	120 mm	225 mm	KOM-707-99-75400	404.58
GRAPPLE	707-01-14011	10001-	P-U-14	70 mm	140 mm	KOM-707-99-52100	145.00
LIFT	707-01-20012	10001-	P-U-14	110 mm	200 mm	KOM-707-99-74010	320.54
STEERING	707-00-11011	10001-	P-U-14	55 mm	110 mm	KOM-707-99-34500	70.56
	707-00-11021	10001-	P-U-14	55 mm	110 mm	KOM-707-99-34500	70.56
MODEL WA600-1							
DUMP	707-01-28015	10001-	P-U-14	140 mm	280 mm	KOM-707-99-84400	340.03
GRAPPLE	707-01-14011	10001-	P-U-14	70 mm	140 mm	KOM-707-99-52100	145.00
LIFT	707-01-22111	10001-	P-U-14	120 mm	225 mm	KOM-707-99-75410	214.45
STEERING	707-01-13071	10001-	P-U-14	70 mm	130 mm	KOM-707-99-43500	128.00
	707-01-13081	10001-	P-U-14	70 mm	130 mm	KOM-707-99-43500	128.00
MODEL WA800-1							
DUMP	707-01-01210	10001-	P-UB-14	180 mm	300 mm	KOM-707-99-96200	1283.66
DUMP (HI-LIFT)	707-01-02100	10001-	P-UB-14	180 mm	300 mm	KOM-707-99-96200	1283.66
LIFT	707-01-01010	10001-	P-UB-14	160 mm	260 mm	KOM-707-99-85900	874.50
LIFT (HI-LIFT)	707-01-02090	10001-	P-UB-14	160 mm	260 mm	KOM-707-99-85900	874.50
STEERING	707-01-16181	10001-	P-UB-14	100 mm	160 mm	KOM-707-99-66210	189.95
	707-01-16191	10001-	P-UB-14	100 mm	160 mm	KOM-707-99-66210	189.95
MODEL WA800-2							
DUMP	707-01-01210	10501-	P-UB-14	180 mm	300 mm	KOM-707-99-96200	1283.66

Replacement Kits For

KOMATSU

KOMATSU

Wheel Loaders							
APPLICATION	CYL #	SERIAL #	CODE	ROD	BORE	KIT #	List \$
MODEL WA800-2							
DUMP (HI-LIFT)	707-01-02100	10501-	P-UB-14	180 mm	300 mm	KOM-707-99-96200	1283.66
LIFT	707-01-01010	10501-	P-UB-14	160 mm	260 mm	KOM-707-99-85900	874.50
LIFT (HI-LIFT)	707-01-02090	10501-	P-UB-14	160 mm	260 mm	KOM-707-99-85900	874.50
STEERING	707-01-16181	10501-	P-UB-14	100 mm	160 mm	KOM-707-99-66210	189.95
	707-01-16191	10501-	P-UB-14	100 mm	160 mm	KOM-707-99-66210	189.95

REPLACEMENT KITS FOR KOMATSU CONSTRUCTION EQUIPMENT

Kit Number	Code (Pg. x)	Rod X Bore Size	List Price	Kit Number	Code (Pg. x)	Rod X Bore Size	List Price
KOM-114-63-05030	P-U-14	40 X 90 mm	\$ 64.55	KOM-707-98-22420	P-U-10	40 X 90 mm	\$ 67.66
KOM-12F-63-05020	P-U-14	45 X 70 mm	60.04	KOM-707-98-22430	P-U-14	40 X 90 mm	69.57
KOM-12F-63-05060	P-U-14	45 X 100 mm	99.98	KOM-707-98-22500	P-U-14	40 X 90 mm	69.13
KOM-130-63-05020	P-U-5	55 X 90 mm	83.35	KOM-707-98-23130	P-U-14	40 X 80 mm	63.28
KOM-141-63-05010	P-U-14	60 X 140 mm	130.90	KOM-707-98-24040	P-U-14	45 X 80 mm	78.84
KOM-141-63-05050	P-U-14	75 X 160 mm	148.52	KOM-707-98-24050	P-U-5	45 X 80 mm	74.57
KOM-144-60-00050K	P-U-10	65 X 110 mm	105.26	KOM-707-98-24150	P-U-14	45 X 80 mm	75.68
KOM-144-63-05050	P-U-14	65 X 110 mm	123.91	KOM-707-98-24430	P-U-14	45 X 90 mm	95.72
KOM-144-63-05080	P-U-14	70 X 160 mm	113.95	KOM-707-98-24500	P-U-14	45 X 90 mm	71.17
KOM-144-63-12200K	P-U-5	65 X 110 mm	152.72	KOM-707-98-24530	P-U-14	45 X 90 mm	103.70
KOM-144-63-52100K	P-U-5	70 X 160	214.43	KOM-707-98-24550	P-U-14	45 X 90 mm	45.85
KOM-175-63-05140	P-U-14	90 X 225 mm	226.23	KOM-707-98-24600	P-U-14	45 X 90 mm	105.54
KOM-707-98-04640	P-U-14	30 X 50 mm	52.70	KOM-707-98-24890	P-U-14	45 X 75 mm	110.04
KOM-707-98-11310	P-U-14	30 X 60 mm	29.14	KOM-707-98-25030	P-U-14	50 X 80 mm	82.55
KOM-707-98-12100	P-U-14	35 X 60 mm	52.99	KOM-707-98-25040	P-U-14	50 X 80 mm	111.09
KOM-707-98-12110	P-U-14	35 X 60 mm	54.10	KOM-707-98-25060	P-U-5	50 X 80 mm	109.75
KOM-707-98-12200	P-U-14	35 X 60 mm	52.99	KOM-707-98-25070	P-U-14	50 X 80 mm	84.10
KOM-707-98-12310	P-U-14	35 X 63 mm	40.95	KOM-707-98-25170	P-U-14	50 X 80 mm	113.16
KOM-707-98-12330	P-U-14	35 X 60 mm	40.95	KOM-707-98-25430	P-U-14	50 X 90 mm	93.18
KOM-707-98-12410	P-U-14	35 X 70 mm	41.85	KOM-707-98-25500	P-U-14	50 X 90 mm	100.80
KOM-707-98-12440	P-U-14	35 X 70 mm	51.51	KOM-707-98-25510	P-U-14	50 X 90 mm	111.79
KOM-707-98-12550	P-U-14	35 X 70 mm	51.63	KOM-707-98-26110	P-U-14	55 X 80 mm	67.78
KOM-707-98-12600	P-U-14	35 X 70 mm	51.69	KOM-707-98-26600	P-U-5	55 X 90 mm	93.93
KOM-707-98-12660	P-U-14	35 X 70 mm	42.04	KOM-707-98-27100	P-U-14	60 X 80 mm	87.30
KOM-707-98-12670	P-U-14	35 X 70 mm	41.85	KOM-707-98-27500	P-U-14	60 X 90 mm	108.52
KOM-707-98-14030	P-U-14	40 X 60 mm	61.84	KOM-707-98-27600	P-UB-14	60 X 90 mm	150.64
KOM-707-98-14240	P-U-14	40 X 60 mm	61.84	KOM-707-98-32050	P-U-14	50 X 100 mm	90.78
KOM-707-98-14430	P-U-14	40 X 70 mm	60.47	KOM-707-98-34120	P-U-14	55 X 100 mm	72.78
KOM-707-98-14600	P-U-14	40 X 70 mm	60.41	KOM-707-98-35100	P-U-14	60 X 100 mm	71.02
KOM-707-98-14610	P-U-14	40 X 70 mm	41.85	KOM-707-98-35110	P-U-14	60 X 100 mm	88.30
KOM-707-98-14700	P-U-14	40 X 70 mm	60.41	KOM-707-98-35130	P-U-14	60 X 100 mm	123.06
KOM-707-98-15650	P-U-14	45 X 70 mm	60.17	KOM-707-98-35510	P-U-14	60 X 110 mm	119.28
KOM-707-98-15700	P-U-14	45 X 70 mm	63.20	KOM-707-98-36100	P-UB-14	65 X 100 mm	105.36
KOM-707-98-15720	P-U-14	45 X 70 mm	88.61	KOM-707-98-36110	P-UB-14	65 X 100 mm	78.84
KOM-707-98-22030	P-U-14	40 X 80 mm	84.28	KOM-707-98-36180	P-U-14	65 X 100 mm	102.46
KOM-707-98-22040	P-U-14	40 X 80 mm	77.67	KOM-707-98-36200	P-UB-14	65 X 95 mm	187.23
KOM-707-98-22100	P-U-14	40 X 80 mm	77.60	KOM-707-98-36210	P-U-14	65 X 95 mm	160.34
KOM-707-98-22110	P-U-14	40 X 80 mm	73.85	KOM-707-98-36230	P-U-14	65 X 100 mm	86.07
KOM-707-98-22120	P-U-14	40 X 80 mm	77.67	KOM-707-98-36500	P-U-14	65 X 110 mm	98.38
KOM-707-98-22410	P-U-10	40 X 90 mm	67.66	KOM-707-98-36510	P-U-14	65 X 110 mm	113.16

REPLACEMENT KITS FOR KOMATSU CONSTRUCTION EQUIPMENT

Kit Number	Code (Pg. x)	Rod X Bore Size	List Price	Kit Number	Code (Pg. x)	Rod X Bore Size	List Price
KOM-707-98-36520	P-U-14	65 X 110 mm	\$ 83.78	KOM-707-98-60110	P-U-14	70 X 160 mm	\$ 113.83
KOM-707-98-36560	P-U-14	65 X 110 mm	98.32	KOM-707-98-60120	P-U-14	70 X 160 mm	115.01
KOM-707-98-37110	P-UB-14	70 X 100 mm	134.05	KOM-707-98-60121	P-U-14	70 X 160 mm	113.90
KOM-707-98-37130	P-UB-14	70 X 100 mm	109.88	KOM-707-98-61100	P-U-14	75 X 160 mm	146.48
KOM-707-98-37500	P-U-14	70 X 110 mm	114.77	KOM-707-98-62100	P-U-14	80 X 160 mm	109.56
KOM-707-98-37570	P-U-14	70 X 110 mm	107.16	KOM-707-98-62120	P-U-14	80 X 160 mm	131.58
KOM-707-98-37620	P-UB-14	70 X 105 mm	200.28	KOM-707-98-64410	P-U-14	90 X 180 mm	133.13
KOM-707-98-38500	P-U-14	75 X 110 mm	111.30	KOM-707-98-64420	P-U-14	90 X 180 mm	134.65
KOM-707-98-38510	P-U-14	75 X 110 mm	117.24	KOM-707-98-64450	P-U-14	90 X 180 mm	128.43
KOM-707-98-38520	P-UB-14	75 X 110 mm	208.32	KOM-707-98-66410	P-U-14	100 X 180 mm	256.48
KOM-707-98-38600	P-U-14	75 X 110 mm	124.10	KOM-707-98-67100	P-U-14	110 X 160 mm	278.19
KOM-707-98-41030	P-U-14	60 X 120 mm	137.21	KOM-707-98-67110	P-U-14	110 X 160 mm	283.33
KOM-707-98-41110	P-U-14	65 X 120 mm	146.29	KOM-707-98-68400	P-U-14	120 X 180 mm	253.52
KOM-707-98-41120	P-U-14	60 X 120 mm	119.83	KOM-707-98-68500	P-U-14	120 X 180 mm	279.43
KOM-707-98-41130	P-U-14	60 X 120 mm	149.01	KOM-707-98-74100	P-U-14	110 X 200 mm	264.34
KOM-707-98-41140	P-U-14	60 X 120 mm	149.14	KOM-707-98-74410	P-U-14	110 X 225 mm	257.76
KOM-707-98-42100	P-U-14	65 X 120 mm	111.73	KOM-707-98-74420	P-U-14	110 X 225 mm	260.52
KOM-707-98-42410	P-U-14	65 X 130 mm	167.69	KOM-707-98-75020	P-U-14	120 X 200 mm	196.94
KOM-707-98-43100	P-U-14	70 X 120 mm	155.69	KOM-707-99-11030	P-U-14	30 X 60 mm	52.55
KOM-707-98-43510	P-U-14	70 X 130 mm	177.45	KOM-707-99-11040	P-UB-14	30 X 60 mm	52.55
KOM-707-98-44120	P-U-14	75 X 120 mm	157.74	KOM-707-99-14200	P-U-14	40 X 60 mm	60.66
KOM-707-98-45200	P-U-14	80 X 120 mm	162.93	KOM-707-99-14600	P-U-14	40 X 70 mm	87.99
KOM-707-98-45220	P-UB-14	80 X 115 mm	208.57	KOM-707-99-14610	P-U-14	40 X 70 mm	50.95
KOM-707-98-45610	P-U-14	80 X 130 mm	156.31	KOM-707-99-15600	P-U-14	45 X 70 mm	88.36
KOM-707-98-45700	P-U-14	80 X 130 mm	185.32	KOM-707-99-22010	P-U-14	40 X 80 mm	72.78
KOM-707-98-46100	P-U-14	85 X 120 mm	137.70	KOM-707-99-22100	P-U-14	40 X 80 mm	104.75
KOM-707-98-46200	P-U-14	85 X 120 mm	169.98	KOM-707-99-24110	P-U-14	45 X 80 mm	74.39
KOM-707-98-46270	P-UB-14	85 X 120 mm	252.10	KOM-707-99-24120	P-U-14	45 X 80 mm	72.04
KOM-707-98-46600	P-U-14	85 X 130 mm	160.76	KOM-707-99-24500	P-U-14	45 X 90 mm	80.03
KOM-707-98-47500	P-U-14	90 X 130 mm	162.13	KOM-707-99-25520	P-U-14	50 X 90 mm	101.09
KOM-707-98-47510	P-U-14	90 X 130 mm	187.47	KOM-707-99-26410	P-U-5	55 X 90 mm	83.35
KOM-707-98-47600	P-U-14	90 X 130 mm	194.34	KOM-707-99-32010	P-U-14	50 X 100 mm	96.77
KOM-707-98-47620	P-UB-14	90 X 130 mm	230.02	KOM-707-99-32100	P-U-14	50 X 100 mm	82.58
KOM-707-98-47680	P-U-14	90 X 130 mm	132.45	KOM-707-99-32110	P-U-14	50 X 100 mm	69.07
KOM-707-98-48500	P-U-14	95 X 130 mm	189.70	KOM-707-99-33010	P-U-14	50 X 100 mm	85.15
KOM-707-98-48510	P-U-14	95 X 130 mm	200.21	KOM-707-99-34030	P-U-5	55 X 100 mm	85.08
KOM-707-98-48600	P-U-14	95 X 130 mm	197.31	KOM-707-99-34100	P-U-14	55 X 100 mm	71.23
KOM-707-98-51100	P-U-14	65 X 140 mm	146.98	KOM-707-99-34500	P-U-14	55 X 110 mm	70.56
KOM-707-98-51110	P-U-5	65 X 140 mm	141.66	KOM-707-99-36200	P-UB-14	65 X 100 mm	152.42
KOM-707-98-52100	P-U-14	70 X 140 mm	178.76	KOM-707-99-36210	P-UB-14	65 X 100 mm	125.83
KOM-707-98-52110	P-U-14	70 X 140 mm	171.03	KOM-707-99-36260	P-U-14	65 X 100 mm	125.58
KOM-707-98-52410	P-U-14	70 X 150 mm	143.88	KOM-707-99-36270	P-U-14	65 X 100 mm	125.46
KOM-707-98-52430	P-U-14	70 X 150 mm	130.22	KOM-707-99-36410	P-U-5	60 X 110 mm	104.38
KOM-707-98-53100	P-U-14	75 X 140 mm	209.92	KOM-707-99-36420	P-U-14	65 X 110 mm	117.11
KOM-707-98-54500	P-U-14	80 X 150 mm	225.70	KOM-707-99-36620	P-UB-14	65 X 105 mm	206.47
KOM-707-98-54510	P-U-14	80 X 150 mm	142.22	KOM-707-99-37500	P-U-14	70 X 110 mm	77.80
KOM-707-98-56600	P-U-14	90 X 150 mm	130.03	KOM-707-99-37600	P-UB-14	70 X 110 mm	137.21
KOM-707-98-56610	P-U-14	90 X 150 mm	139.32	KOM-707-99-37610	P-UB-14	70 X 110 mm	219.26
KOM-707-98-57201	P-U-14	95 X 140 mm	100.11	KOM-707-99-40040	P-U-14	55 X 120 mm	133.37
KOM-707-98-58200	P-U-14	100 X 140 mm	195.26	KOM-707-99-40100	P-U-5	50 X 120 mm	128.98
KOM-707-98-58210	P-U-14	100 X 140 mm	159.29	KOM-707-99-41100	P-U-14	60 X 120 mm	103.57
KOM-707-98-58230	P-U-14	100 X 140 mm	109.38	KOM-707-99-41140	P-U-14	60 X 120 mm	145.25

REPLACEMENT KITS FOR KOMATSU CONSTRUCTION EQUIPMENT

KOMATSU

Kit Number	Code (Pg. x)	Rod X Bore Size	List Price
KOM-707-99-43010	P-U-5	70 X 120 mm	\$ 119.09
KOM-707-99-43100	P-U-14	70 X 120 mm	125.27
KOM-707-99-43500	P-U-14	70 X 130 mm	128.00
KOM-707-99-43540	P-U-14	70 X 130 mm	168.31
KOM-707-99-44200	P-UB-14	75 X 115 mm	243.12
KOM-707-99-46200	P-UB-14	85 X 120 mm	269.72
KOM-707-99-46210	P-UB-14	85 X 120 mm	225.45
KOM-707-99-46600	P-UB-14	85 X 120 mm	267.55
KOM-707-99-47600	P-UB-14	90 X 130 mm	272.62
KOM-707-99-47610	P-UB-14	90 X 130 mm	230.33
KOM-707-99-48610	P-UB-14	95 X 130 mm	277.38
KOM-707-99-52100	P-U-14	70 X 140 mm	145.00
KOM-707-99-53500	P-U-14	75 X 150 mm	143.74
KOM-707-99-54100	P-U-14	80 X 140 mm	112.41
KOM-707-99-55500	P-U-14	85 X 150 mm	119.84
KOM-707-99-56310	P-U-14	90 X 140 mm	256.50
KOM-707-99-56500	P-U-14	90 X 150 mm	151.18
KOM-707-99-57200	P-UB-14	95 X 135 mm	300.38
KOM-707-99-58110	P-UB-14	100 X 140 mm	288.46
KOM-707-99-58200	P-UB-14	100 X 140 mm	307.12
KOM-707-99-58210	P-UB-14	100 X 140 mm	341.69
KOM-707-99-62010	P-U-14	80 X 160 mm	131.58
KOM-707-99-62020	P-U-14	80 X 160 mm	125.22
KOM-707-99-64010	P-U-14	90 X 160 mm	128.48
KOM-707-99-64400	P-U-14	90 X 180 mm	194.02
KOM-707-99-64410	P-U-14	90 X 180 mm	133.45

Kit Number	Code (Pg. x)	Rod X Bore Size	List Price
KOM-707-99-65400	P-U-14	95 X 180 mm	\$ 138.01
KOM-707-99-66010	P-U-14	100 X 160 mm	132.20
KOM-707-99-66210	P-U-14	100 X 160 mm	189.95
KOM-707-99-66400	P-U-14	100 X 180 mm	279.36
KOM-707-99-67010	P-UB-14	110 X 160 mm	321.96
KOM-707-99-67110	P-UB-14	110 X 160 mm	381.70
KOM-707-99-67120	P-UB-14	110 X 160 mm	377.02
KOM-707-99-68510	P-UB-14	120 X 185 mm	390.29
KOM-707-99-69600	P-U-14	130 X 180 mm	296.27
KOM-707-99-69620	P-U-14	130 X 180 mm	313.30
KOM-707-99-71100	P-U-14	90 X 200 mm	159.03
KOM-707-99-71420	P-U-14	90 X 225 mm	190.21
KOM-707-99-73010	P-U-14	100 X 200 mm	303.63
KOM-707-99-73020	P-U-14	100 X 200 mm	303.63
KOM-707-99-74010	P-U-14	110 X 200 mm	320.54
KOM-707-99-75400	P-U-14	120 X 225 mm	404.58
KOM-707-99-75410	P-U-14	120 X 225 mm	214.45
KOM-707-99-77240	P-U-14	140 X 200 mm	511.04
KOM-707-99-77250	P-U-14	140 X 200 mm	463.57
KOM-707-99-78620	P-UB-14	160 X 225 mm	785.71
KOM-707-99-78630	P-UB-14	160 X 225 mm	785.47
KOM-707-99-84400	P-U-14	140 X 280 mm	340.03
KOM-707-99-85900	P-UB-14	160 X 260 mm	874.50
KOM-707-99-89200	P-U-14	170 X 250 mm	602.41
KOM-707-99-96200	P-UB-14	180 X 300 mm	1283.66

REPLACEMENT KITS FOR KOMATSU LIFT TRUCKS

NOTE: Komatsu part numbers are used as a reference only. We do not imply that these kits are original REPLACEMENT PARTS.

Kit Number	Code (Pg. x)	Rod X Bore Size	List Price
KOM-34A-63-05010	I-U-4,12	50 X 70 mm	\$ 99.62
KOM-34A-64-05010	I-U-1	30mm Rod Kit	15.22
KOM-34B-63-05011	I-U-4,10	55 X 80 mm	102.52
KOM-34B-63-05021	I-U-4,10	60 X 80 mm	97.94
KOM-34B-64-05010	I-U-1	35 X 50 mm	21.95
KOM-3EA-64-05020	I-U-1	25 X 60 mm	24.24
KOM-3EA-64-05030	I-U-1	35mm Rod Kit	26.34
KOM-3EA-64-05190	I-U-10	1 X 2-1/2	26.38
KOM-3EB-34-05010	O-Ring Kit		13.05
KOM-3EB-63-05010	P-U-4	40 X 50 mm	58.12
KOM-3EB-63-05020	P-U-4	45 X 55 mm	81.49
KOM-3EB-64-05010	I-U-1	25 X 50 mm	20.64
KOM-3EB-64-05020	I-U-1	25 X 50 mm	31.61

Kit Number	Code (Pg. x)	Rod X Bore Size	List Price
KOM-3EB-64-05020L	P-U-10	25 X 50mm	\$ 18.24
KOM-3EB-64-05050	I-U-1	30 X 70 mm	25.11
KOM-3EB-64-05050L	I-U-3	30 X 70 mm	21.96
KOM-3EB-64-05060	I-U-1	35 X 65 mm	21.45
KOM-3EB-64-05091	I-U-3	30 X 70	17.84
KOM-3EB-64-05190	I-U-10	1-1/4 X 2-3/4	31.73
KOM-3EB-64-A2000	I-U-10	1-5/8 X 2-1/2	40.69
KOM-3EB-64-A5191	I-U-10	1-1/4 X 2-3/4	52.98
KOM-3EC-63-05020	P-U-4	50 X 70	40.17
KOM-3EC-64-05010L	I-U-3	45 X 90 mm	25.19
KOM-3EC-64-05190	I-U-10	1-3/4 X 3-1/2	29.81
KOM-3EC-64-A2390	I-U-10	1 X 2	21.93
KOM-ON43001-07567	I-U-10	50 X 75 mm	66.26

REPLACEMENT PARTS FOR KOMATSU EQUIPMENT

NOTE: Komatsu part numbers are used as a reference only. We do not imply that these kits are original REPLACEMENT PARTS.

WIPERS

Part Number	Rod Diam.	List Price
KOM-175-63-75190	35 mm	\$ 11.80
KOM-07016-20407	40 mm	14.42
KOM-198-63-75190	40 mm	14.42
KOM-707-56-45510	40 mm	14.42
KOM-07016-20457	45 mm	15.73
KOM-07016-20507	50 mm	16.51
KOM-113-30-24240	50 mm	16.51
KOM-130-09-12931	50 mm	16.49
KOM-07016-00558	55 mm	18.88
KOM-707-56-55510	55 mm	18.88
KOM-07016-20608	60 mm	20.45
KOM-141-63-93270	60 mm	20.45
KOM-07016-00658	65 mm	21.69
KOM-07016-20658	65 mm	21.69
KOM-144-63-92170	65 mm	21.69
KOM-07016-00708	70 mm	23.27
KOM-07016-20708	70 mm	23.27
KOM-144-63-95170	70 mm	23.27
KOM-07016-20758	75 mm	25.03
KOM-144-63-94170	75 mm	25.03
KOM-07016-20808	80 mm	29.50
KOM-195-63-92190	80 mm	29.50
KOM-07016-20858	85 mm	33.49
KOM-707-56-85510	85 mm	33.49
KOM-07016-00908	90 mm	36.21
KOM-195-63-74170	90 mm	36.21
KOM-195-63-94170	90 mm	36.21
KOM-07016-20958	95 mm	37.03
KOM-707-56-95510	95 mm	36.57
KOM-07016-01008	100 mm	38.01
KOM-07016-21008	100 mm	38.01
KOM-176-63-56170	100 mm	38.01
KOM-208-70-12231	100 mm	24.33
KOM-07016-21109	110 mm	38.93
KOM-198-63-94170	110 mm	38.93
KOM-07016-21209	120 mm	42.61
KOM-195-63-93170	120 mm	42.61
KOM-707-56-13520	130 mm	46.64
KOM-07016-21400	140 mm	47.78
KOM-198-50-11171	140 mm	10.76
KOM-566-63-22241	160 mm	61.78
KOM-707-56-17580	170 mm	68.90

ROD U-SEALS

Part Number	Rod Diam.	List Price
KOM-707-51-30210	30 mm	\$ 6.02
KOM-707-51-40030	40 mm	9.39
KOM-707-51-40210	40 mm	8.68
KOM-707-51-45210	45 mm	8.11
KOM-707-51-50110	50 mm	13.31
KOM-707-51-50210	50 mm	11.07
KOM-707-51-50211	50 mm	11.07
KOM-130-63-12173	55 mm	12.72
KOM-707-51-55110	55 mm	12.72
KOM-707-51-55211	55 mm	13.80
KOM-707-51-60060	60 mm	19.84
KOM-707-51-60211	60 mm	19.84
KOM-707-51-65030	65 mm	20.19
KOM-707-51-65110	65 mm	12.15
KOM-707-51-65211	65 mm	20.19
KOM-154-63-42370	70 mm	16.59
KOM-154-63-42373	70 mm	16.59
KOM-707-51-70030	70 mm	21.15
KOM-707-51-70110	70 mm	16.59
KOM-707-51-70211	70 mm	21.15
KOM-707-51-75030	75 mm	22.86
KOM-707-51-75110	75 mm	16.72
KOM-707-51-75211	78 mm	22.86
KOM-707-51-80030	80 mm	23.60
KOM-707-51-80110	80 mm	18.39
KOM-707-51-80211	80 mm	23.60
KOM-707-51-85030	85 mm	25.47
KOM-707-51-85211	85 mm	25.47
KOM-154-63-52171	90 mm	20.41
KOM-154-63-52173	90 mm	20.41
KOM-707-51-90030	90 mm	27.10
KOM-707-51-90110	90 mm	20.41
KOM-707-51-90211	90 mm	27.10
KOM-707-51-95030	95 mm	28.31
KOM-707-51-95211	95 mm	28.31
KOM-707-51-10030	100 mm	28.61
KOM-707-51-10110	100 mm	22.41
KOM-707-51-10130	100 mm	28.61
KOM-707-51-10211	100 mm	28.61
KOM-707-51-11110	110 mm	29.88
KOM-707-51-12110	120 mm	34.70
KOM-707-51-14110	140 mm	37.30
KOM-707-51-14130	140 mm	37.30
KOM-707-51-17130	170 mm	51.36

PISTON SEALS

Part Number	Bore Diam.	List Price
KOM-707-44-60180	60 mm	\$ 28.56
KOM-707-44-70070	70 mm	28.56
KOM-707-44-70080	70 mm	28.56
KOM-707-44-70180	70 mm	28.56
KOM-707-44-80080	80 mm	31.05
KOM-707-44-80180	80 mm	31.05
KOM-707-51-80630	80 mm	25.83
KOM-707-51-85630	85 mm	27.72
KOM-707-44-90070	90 mm	35.68
KOM-707-44-90080	90 mm	35.68
KOM-707-44-90180	90 mm	35.68
KOM-707-51-90630	90 mm	33.45
KOM-707-44-95180	95 mm	35.68
KOM-707-51-95630	95 mm	35.32
KOM-110-61-14250	100 mm	23.46
KOM-707-42-12012	100 mm	23.46
KOM-707-44-10080	100 mm	38.53
KOM-707-44-10180	100 mm	38.53
KOM-707-51-10630	100 mm	36.34
KOM-707-51-10640	100 mm	36.34
KOM-707-44-10280	105 mm	39.49
KOM-707-44-11080	110 mm	40.22
KOM-707-44-11180	110 mm	40.22
KOM-707-44-11280	115 mm	44.42
KOM-707-44-12080	120 mm	41.91
KOM-707-44-12180	120 mm	41.91
KOM-707-44-12280	125 mm	46.59
KOM-707-44-13080	130 mm	50.34
KOM-707-44-13180	130 mm	50.34
KOM-707-44-13280	135 mm	53.57
KOM-707-44-14080	140 mm	57.02
KOM-707-44-14180	140 mm	57.02
KOM-707-44-14280	145 mm	57.42
KOM-707-44-15080	150 mm	62.02
KOM-707-44-15180	150 mm	62.02
KOM-707-44-16080	160 mm	70.45
KOM-707-44-16180	160 mm	70.45
KOM-707-44-16280	165 mm	77.90
KOM-707-44-18080	180 mm	73.83
KOM-707-44-18180	180 mm	73.83
KOM-707-44-18280	185 mm	77.20
KOM-707-44-20080	200 mm	87.19
KOM-707-44-20180	200 mm	87.19
KOM-707-44-22080	225 mm	111.04

REPLACEMENT PARTS FOR KOMATSU EQUIPMENT

NOTE: Komatsu part numbers are used as a reference only. We do not imply that these kits are original REPLACEMENT PARTS.

PISTON SEALS

Part Number	Bore Diam.	List Price
KOM-707-44-22180	225 mm	\$ 111.04
KOM-707-44-22280	225 mm	111.04
KOM-707-44-25080	250 mm	118.60
KOM-707-44-25180	250 mm	118.60
KOM-707-44-26180	260 mm	118.60
KOM-707-44-28080	280 mm	132.99
KOM-707-44-28180	280 mm	132.99

ROD BUSHING

Part Number	Rod Diam.	List Price
KOM-07177-05530	55 mm	\$ 30.90
KOM-07177-06530	65 mm	31.55
KOM-07177-07015	70 mm	29.07
KOM-07177-07030	70 mm	32.55
KOM-07177-07530	75 mm	33.73
KOM-07177-08030	80 mm	43.91
KOM-07177-08040	80 mm	49.45
KOM-707-52-10850	85 mm	54.29
KOM-07177-09035	90 mm	38.67
KOM-07177-09040	90 mm	40.38
KOM-07177-01035	100 mm	54.12
KOM-07177-01040	100 mm	54.12
KOM-07177-01140	110 mm	54.71
KOM-07177-01240	120 mm	56.10
KOM-707-52-11210	120 mm	95.28
KOM-707-52-11410	140 mm	288.02

WEAR RINGS

Part Number	Rod Diam.	List Price
KOM-07155-00615	60 X 14.5 mm	\$ 7.27
KOM-07155-00720	70 X 20 mm	6.60
KOM-07155-00820	80 X 20 mm	16.29
KOM-07155-00925	90 X 25 mm	11.07
KOM-07155-01025	100 X 25 mm	11.07
KOM-07155-01125	110 X 25 mm	14.11
KOM-07155-01230	120 X 30 mm	17.11
KOM-07155-01330	130 X 30 mm	25.92
KOM-07155-01435	140 X 35 mm	8.16
KOM-07155-01535	150 X 35 mm	38.40
KOM-07155-01640	160 X 40 mm	40.04
KOM-07155-01845	180 X 45 mm	14.64
KOM-07155-02045	200 X 45 mm	20.37
KOM-07155-02250	225 X 50 mm	55.57
KOM-07155-02555	250 X 55 mm	71.38
KOM-07155-02860	280 X 60 mm	98.59
KOM-07156-01620	160 X 20 mm	32.48
KOM-07156-01822	180 X 22.5 mm	47.46
KOM-07156-02022	200 X 22 mm	15.05
KOM-07156-02225	225 X 25 mm	55.39
KOM-707-39-10520	105 X 12.5 mm	19.07
KOM-707-39-11110	110 X 12.5 mm	27.32
KOM-707-39-11510	115 X 15 mm	32.19
KOM-707-39-12110	120 X 15 mm	34.09
KOM-707-39-13110	130 X 15 mm	34.45
KOM-707-39-13510	135 X 15 mm	37.40
KOM-707-39-14820	140 X 17.5 mm	42.25
KOM-707-39-15820	150 X 17.5 mm	29.15
KOM-707-39-16820	160 X 20 mm	47.09
KOM-707-39-18830	185 X 22.5 mm	53.29
KOM-707-39-25820	250 X 27.5 mm	41.16
KOM-707-39-90110	90 X 12.5 mm	18.53
KOM-707-39-95120	95 X 12.5 mm	18.79
KOM-707-44-01580	150 X 17.5 mm	29.15



DUST SEALS

Part Number	Rod Diam.	List Price
KOM-07145-00045	45 mm	\$ 7.03
KOM-07145-00050	50 mm	7.75
KOM-07145-00055	55 mm	8.42
KOM-07145-00060	60 mm	9.37
KOM-07145-00065	65 mm	10.50
KOM-07145-00070	70 mm	13.71
KOM-07145-00075	75 mm	11.89
KOM-07145-00080	80 mm	13.58
KOM-07145-00085	85 mm	14.29
KOM-07145-00090	90 mm	15.61
KOM-07145-00095	95 mm	16.53
KOM-07145-00100	100 mm	17.48
KOM-07145-00110	110 mm	18.61
KOM-07145-00120	120 mm	19.77

O-RINGS

Part Number	Min Pkg Qty	List Price
KOM-07000-01125	5	\$ 1.53
KOM-07000-02005	100	.05
KOM-07000-02010	100	.05
KOM-07000-02011	100	.05
KOM-07000-02012	100	.05
KOM-07000-02014	100	.06
KOM-07000-02015	100	.06
KOM-07000-02016	100	.06
KOM-07000-02018	100	.06
KOM-07000-02020	100	.07
KOM-07000-02050	10	.55
KOM-07000-02055	10	.58
KOM-07000-02060	10	.65
KOM-07000-02065	10	.68
KOM-07000-02070	10	.83
KOM-07000-02075	5	.98
KOM-07000-02080	5	1.00
KOM-07000-02085	5	1.02
KOM-07000-02090	5	1.04
KOM-07000-02095	5	1.07
KOM-07000-02100	5	1.16
KOM-07000-02105	5	1.19
KOM-07000-02110	5	1.33
KOM-07000-02115	5	1.53

REPLACEMENT PARTS FOR KOMATSU EQUIPMENT

NOTE: Komatsu part numbers are used as a reference only. We do not imply that these kits are original REPLACEMENT PARTS.

O-RINGS

Part Number	Min Pkg Qty	List Price
KOM-07000-02120	5	\$ 1.59
KOM-07000-02125	5	1.61
KOM-07000-02130	5	1.63
KOM-07000-02135	2	1.92
KOM-07000-02140	2	1.95
KOM-07000-02145	5	1.96
KOM-07000-03022	25	.20
KOM-07000-03025	25	.21
KOM-07000-03028	20	.27
KOM-07000-03030	20	.27
KOM-07000-03032	20	.28
KOM-07000-03035	20	.36
KOM-07000-03038	20	.37
KOM-07000-03040	20	.38
KOM-07000-03042	20	.38
KOM-07000-03045	10	.50
KOM-07000-03048	10	.51
KOM-07000-03050	10	.52
KOM-07000-03070	10	.34
KOM-07000-03092	10	.45
KOM-07000-03095	10	.46
KOM-07000-03098	10	.47
KOM-07000-03105	10	.55
KOM-07000-03110	10	.57
KOM-07000-03115	4	.72
KOM-07000-03120	4	.76
KOM-07000-03130	4	.84
KOM-07000-03140	4	.98
KOM-07000-05055	5	1.41
KOM-07000-05060	2	1.91
KOM-07000-05065	2	2.42
KOM-07000-05070	2	2.43
KOM-07000-05075	2	2.59
KOM-07000-05080	2	2.66
KOM-07000-05085	2	2.75
KOM-07000-05090	2	2.82
KOM-07000-05095	2	2.92
KOM-07000-05100	2	2.97
KOM-07000-05105	2	3.79
KOM-07000-05110	2	3.86

O-RINGS

Part Number	Min Pkg Qty	List Price
KOM-07000-05120	2	\$ 4.01
KOM-07000-05125	2	4.08
KOM-07000-05130	2	4.09
KOM-07000-05135	2	4.16
KOM-07000-05140	2	4.22
KOM-07000-05145	2	4.28
KOM-07000-05150	2	5.11
KOM-07000-05155	2	3.25
KOM-07000-05160	2	3.23
KOM-07000-05165	2	3.26
KOM-07000-05170	2	3.31
KOM-07000-05175	2	4.46
KOM-07000-05180	2	4.52
KOM-07000-05185	2	4.57
KOM-07000-05190	2	4.60
KOM-07000-05195	2	4.65
KOM-07000-05200	2	5.43
KOM-07000-05210	2	5.53
KOM-07000-05220	2	5.64
KOM-07000-05225	1	5.73
KOM-07000-05230	1	5.73
KOM-07000-05235	1	6.15
KOM-07000-05240	1	6.28
KOM-07000-05250	1	6.59
KOM-07000-05260	1	7.24
KOM-07000-05270	1	7.29
KOM-07000-05280	1	7.70
KOM-07000-05290	1	8.14
KOM-07000-05300	1	8.20
KOM-07000-05305	1	9.59
KOM-07000-05310	1	9.59
KOM-07000-05345	1	10.66
KOM-07000-05400	1	14.67
KOM-07000-05430	1	15.56
KOM-07000-05435	1	15.85
KOM-07000-05440	1	16.14
KOM-07000-05445	1	16.24
KOM-07000-05460	1	17.12
KOM-07000-05465	1	17.23
KOM-07000-05470	1	17.42

O-RINGS

Part Number	Min Pkg Qty	List Price
KOM-07000-05480	1	\$ 17.81
KOM-07000-05490	1	18.07
KOM-07000-05495	1	18.20
KOM-07000-05500	1	18.50
KOM-07000-22070	10	.83
KOM-07000-32055	10	.58
KOM-07000-62018	100	.06
KOM-07000-62070	10	.83
KOM-07000-62115	5	1.53
KOM-07000-62130	5	1.63
KOM-07000-63045	10	.50
KOM-07000-65190	2	4.60
KOM-07002-02034	20	.07
KOM-07002-02434	20	.08
KOM-07002-03634	20	.13
KOM-07002-12034	20	.07
KOM-07002-13034	20	.12
KOM-07002-13634	20	.13
KOM-198-63-43430	2	1.27
KOM-21T-09-11430	25	.21
KOM-21T-09-11450	20	.27
KOM-21T-09-11460	2	3.51
KOM-21T-09-11470	2	6.11

O-RINGS 90 DUROMETER

Part Number	Min Pkg Qty	List Price
KOM-07000-11009	50	\$.14
KOM-07000-12010	25	.23
KOM-07000-12011	25	.24
KOM-07000-12012	25	.24
KOM-07000-12014	20	.33
KOM-07000-12015	20	.32
KOM-07000-12016	20	.32
KOM-07000-12018	20	.33
KOM-07000-12055	10	.93
KOM-07000-12060	5	1.07
KOM-07000-12065	5	1.06
KOM-07000-12070	5	1.08

REPLACEMENT PARTS FOR KOMATSU EQUIPMENT

NOTE: Komatsu part numbers are used as a reference only. We do not imply that these kits are original REPLACEMENT PARTS.

O-RINGS 90 DUROMETER

Part Number	Min Pkg Qty	List Price
KOM-07000-12075	5	\$ 4.13
KOM-07000-12080	5	1.29
KOM-07000-12085	5	1.34
KOM-07000-12090	5	1.36
KOM-07000-12095	5	1.39
KOM-07000-12100	5	1.51
KOM-07000-12105	5	1.54
KOM-07000-12110	5	1.57
KOM-07000-12115	5	1.59
KOM-07000-12125	5	1.76
KOM-07000-12130	5	1.78
KOM-07000-12135	2	2.08
KOM-07000-12145	5	2.12
KOM-07000-13022	25	.27
KOM-07000-13025	20	.42
KOM-07000-13028	10	.59
KOM-07000-13030	10	.70
KOM-07000-13032	10	.74
KOM-07000-13035	10	.77
KOM-07000-13038	10	.82
KOM-07000-13040	10	.84
KOM-07000-13042	10	.87
KOM-07000-13045	5	.95
KOM-07000-13048	5	1.23
KOM-07000-13050	5	1.26
KOM-07000-13090	8	.71
KOM-07000-13110	2	4.01
KOM-07000-13140	3	1.70
KOM-07000-15058	2	1.96
KOM-07000-15070	2	2.60
KOM-07000-15085	2	2.85
KOM-07000-15090	2	3.24
KOM-07000-15095	2	5.05
KOM-07000-15100	2	3.86
KOM-07000-15105	2	3.93
KOM-07000-15110	2	4.01
KOM-07000-15115	2	4.09
KOM-07000-15120	2	4.18
KOM-07000-15125	2	4.18
KOM-07000-15130	2	4.18

O-RINGS 90 DUROMETER

Part Number	Min Pkg Qty	List Price
KOM-07000-15135	2	\$ 4.24
KOM-07000-15140	2	4.27
KOM-07000-15145	2	4.35
KOM-07000-15150	2	4.54
KOM-07000-15160	2	5.61
KOM-07000-15165	1	6.81
KOM-07000-15170	1	6.88
KOM-07000-15175	1	7.00
KOM-07000-15180	1	7.81
KOM-07000-15185	1	7.91
KOM-07000-15190	1	7.99
KOM-07000-15195	1	8.08
KOM-07000-15200	1	10.41
KOM-07000-15220	1	14.65
KOM-07000-15230	1	15.18
KOM-07000-15240	1	16.13
KOM-07000-15250	1	17.77
KOM-07000-15260	1	18.82
KOM-07000-15270	1	18.95
KOM-07000-15275	1	18.97
KOM-07000-15280	1	19.93
KOM-07000-15290	1	23.52
KOM-07000-16150	2	3.50
KOM-07002-03034	20	.27

BACK-UP RINGS

Part Number	Min Pkg Qty	List Price
KOM-07001-02018	1	\$ 1.01
KOM-07001-02020	1	1.01
KOM-07001-02055	1	2.08
KOM-07001-02060	1	4.44
KOM-07001-02065	1	2.51
KOM-07001-02070	1	4.55
KOM-07001-02075	1	4.55
KOM-07001-02080	1	4.61
KOM-07001-02085	1	4.66
KOM-07001-02090	1	4.66
KOM-07001-02095	1	4.66

BACK-UP RINGS

Part Number	Min Pkg Qty	List Price
KOM-07001-03022	1	\$ 1.01
KOM-07001-03040	1	1.28
KOM-07001-05055	1	4.49
KOM-07001-05090	1	6.47
KOM-07001-05095	1	3.92
KOM-07001-05100	1	4.03
KOM-07001-05110	1	4.45
KOM-07001-05115	1	4.66
KOM-07001-05118	1	7.21
KOM-07001-05120	1	4.88
KOM-07001-05125	1	5.09
KOM-07001-05130	1	5.19
KOM-07001-05135	1	5.41
KOM-07001-05155	1	6.15
KOM-07001-05170	1	6.68
KOM-07001-05175	1	7.19
KOM-07001-05180	1	7.21
KOM-07001-05220	1	22.38
KOM-07146-02006	1	4.66
KOM-07146-02066	1	2.51
KOM-07146-02076	1	4.55
KOM-07146-02086	1	4.66
KOM-07146-02096	1	4.66
KOM-07146-02106	1	4.89
KOM-07146-02116	1	5.00
KOM-07146-02126	1	5.04
KOM-07146-02128	1	5.11
KOM-07146-02136	1	5.34
KOM-07146-02146	1	6.01
KOM-07146-05152	1	5.94
KOM-07146-05172	1	6.68
KOM-07146-05192	1	7.53
KOM-07146-05242	1	9.54
KOM-111-63-81230	1	5.04
KOM-178-63-22460	1	12.08
KOM-20D-63-32290	1	5.00
KOM-569-63-42190	1	7.31
KOM-707-35-52660	1	4.44
KOM-707-35-52690	1	4.66
KOM-707-35-52700	1	4.55

REPLACEMENT PARTS FOR KOMATSU EQUIPMENT

NOTE: Komatsu part numbers are used as a reference only. We do not imply that these kits are original REPLACEMENT PARTS.

BACK-UP RINGS

Part Number	Min Pkg Qty	List Price
KOM-707-35-52760	1	\$ 4.55
KOM-707-35-52830	1	4.66
KOM-707-35-52860	1	5.00
KOM-707-35-52880	1	5.34
KOM-707-35-52900	1	4.44
KOM-707-35-52910	1	4.55
KOM-707-35-52911	1	5.94
KOM-707-35-52920	1	4.61
KOM-707-35-52930	1	4.66

BACK-UP RINGS

Part Number	Min Pkg Qty	List Price
KOM-707-35-52940	1	\$ 4.78
KOM-707-35-52950	1	4.89
KOM-707-35-90960	1	3.39
KOM-707-35-91010	1	.95
KOM-707-35-91100	1	4.89
KOM-707-35-91140	1	5.41
KOM-707-35-91200	1	5.00
KOM-707-35-91440	1	5.41
KOM-707-35-91550	1	5.83

BACK-UP RINGS

Part Number	Min Pkg Qty	List Price
KOM-707-35-91650	1	\$ 6.15
KOM-707-35-91750	1	6.57
KOM-707-35-91850	1	1.23
KOM-707-35-92600	1	4.44
KOM-707-35-92900	1	1.45
KOM-707-35-93020	1	14.05
KOM-707-35-99500	1	1.11
KOM-707-35-99510	1	1.45



KINGSEAL CO., LTD. THAILAND

46/152-153 Moo 3 Sri Saman Road
Baan Mai Pakkret, Nonthaburi Thailand 11120

Tel: +662 9617534 to 6

Fax: +662 9617540

Email: intlsales@kingseal.co.th / kingsealmail@gmail.com

Website: <http://www.kingseal.co.th>

Replacement Kits For

KUBOTA

KUBOTA

Excavators							
APPLICATION	CYL #	SERIAL #	CODE	ROD	BORE	KIT #	List \$
MODEL KH-28L							
ARM	68271-67600		I-U-5	55 mm	90 mm	KUB-68271-99400	90.79
BOOM LH	68271-67510		I-U-5	50 mm	80 mm	KUB-68271-99300	84.29
BOOM RH	68271-67520		I-U-5	50 mm	80 mm	KUB-68271-99300	84.29
BUCKET	68271-67800		I-U-5	50 mm	80 mm	KUB-68271-99500	84.29
DOZER	68081-75100		I-U-5	45 mm	80 mm	KUB-68271-99800	83.37
SWING	68271-67400		I-U-5	55 mm	100 mm	KUB-68271-99600	95.39
MODEL KH-41(H)							
ARM	68501-67600		I-U-10	30 mm	50 mm	KUB-68721-91130	32.13
	68511-67600		I-U-10	30 mm	55 mm	KUB-68511-91110	32.86
BOOM	68501-67503		P-U-10	30 mm	55 mm	KUB-68191-91020	41.98
	68511-67503		P-U-10	30 mm	55 mm	KUB-68191-91020	41.98
BUCKET	68501-67800		I-U-10	30 mm	50 mm	KUB-68721-91130	32.13
	68511-67800		I-U-10	30 mm	55 mm	KUB-68511-91110	32.86
DOZER	68501-75100		I-U-10	35 mm	65 mm	KUB-68721-91160	55.58
	68511-75102		I-UB-10	35 mm	70 mm	KUB-68511-91120	35.58
SWING	68513-67400		P-U-10	30 mm	55 mm	KUB-68511-91010	134.42
MODEL KH-90(H)							
ARM	68761-67602		P-UB-10	45 mm	80 mm	KUB-68761-91130	174.65
BOOM	68761-67501		P-U-10	45 mm	90 mm	KUB-68761-91120	201.34
BUCKET	68761-67802		P-UB-10	45 mm	70 mm	KUB-68761-91040	77.59
DOZER	68761-75101		P-UB-10	45 mm	90 mm	KUB-68761-91150	197.36
SWING	68741-67401		P-UB-10	45 mm	70 mm	KUB-68741-91010	88.28
MODEL KH-91(H)							
ARM	68571-67600		P-U-10	45 mm	80 mm	KUB-68581-91030	75.53
BOOM	68581-67500		P-U-10	45 mm	90 mm	KUB-68581-91020	73.47
BUCKET	68541-67800		P-U-10	40 mm	70 mm	KUB-68761-91060	37.82
DOZER	68581-75100		P-UB-10	45 mm	90 mm	KUB-68761-91050	91.84
SWING	68541-67400		P-UB-10	40 mm	80 mm	KUB-68541-91010	161.39
MODEL KH-171L							
ARM	68271-67600		I-U-5	55 mm	90 mm	KUB-68271-99400	90.79
BOOM LH	68271-67510		I-U-5	50 mm	80 mm	KUB-68271-99300	84.29
BOOM RH	68271-67520		I-U-5	50 mm	80 mm	KUB-68271-99300	84.29
BUCKET	68271-67800		I-U-5	50 mm	80 mm	KUB-68271-99500	84.29
DOZER	68081-75100		I-U-5	45 mm	80 mm	KUB-68271-99800	83.37
SWING	68271-67400		I-U-5	55 mm	100 mm	KUB-68271-99600	95.39
MODEL KH-191							
ARM	68493-67600		P-U-10	55 mm	90 mm	KUB-68493-91030	59.18
BOOM	68493-67502		P-U-10	65 mm	120 mm	KUB-68493-91020	102.71
BUCKET	68493-67800		P-U-10	50 mm	80 mm	KUB-68493-91040	51.17
DOZER	68493-75100		P-U-10	60 mm	110 mm	KUB-68493-91050	127.01
SWING	68499-67400		P-U-10	55 mm	100 mm	KUB-68499-91010	92.63
MODEL KX41(H)							
ARM	RB208-67600		P-U-10	35 mm	60 mm	KUB-RB201-91050	56.95
BLADE	RB208-75100		P-U-10	35 mm	70 mm	KUB-RB201-91030	40.20
BOOM	RB208-67700		P-U-10	30 mm	55 mm	KUB-RB201-91010	40.20
BUCKET	RB108-67800	-11244	P-U-10	30 mm	55 mm	KUB-RB101-91020	56.83
	RB208-67800	11245	P-U-10	30 mm	55 mm	KUB-RB101-91020	56.83
SWING	RB108-67400		P-U-10	30 mm	55 mm	KUB-RB101-91020	56.83

Replacement Kits For

KUBOTA

Excavators

APPLICATION	CYL #	SERIAL #	CODE	ROD	BORE	KIT #	List \$
MODEL KX101(H)							
ARM	68658-67600		P-U-10	45 mm	80 mm	KUB-68651-91030	82.97
BLADE	68318-75100		P-U-10	45 mm	90 mm	KUB-68301-91050	76.08
BOOM	68658-67700		P-U-10	45 mm	90 mm	KUB-68651-91020	46.78
BUCKET	68396-67800		P-U-10	40 mm	70 mm	KUB-68861-93300	71.45
SWING	68316-67400		P-U-10	40 mm	80 mm	KUB-68311-91010	80.30

REPLACEMENT KITS FOR KUBOTA EQUIPMENT

NOTE: Kubota part numbers are used as a reference only. We do not imply that these kits are original REPLACEMENT PARTS.

Kit Number	Code (Pg. x)	Rod X Bore Size	List Price
KUB-68271-99300	I-U-5	50 X 80 mm	\$ 84.29
KUB-68271-99400	I-U-5	55 X 90 mm	90.79
KUB-68271-99500	I-U-5	50 X 80 mm	84.29
KUB-68271-99600	I-U-5	55 X 100 mm	95.39
KUB-68271-99800	I-U-5	45 X 80 mm	83.37
KUB-68301-91050	P-U-10	45 X 90 mm	76.08
KUB-68311-91010	P-U-10	40 X 80 mm	80.30
KUB-68493-91020	P-U-10	65 X 120 mm	102.71
KUB-68493-91030	P-U-10	55 X 90 mm	59.18
KUB-68493-91040	P-U-10	50 X 80 mm	51.17
KUB-68493-91050	P-U-10	60 X 110 mm	127.01
KUB-68499-91010	P-U-10	55 X 100 mm	92.63
KUB-68511-91010	P-U-10	30 X 55 mm	134.42
KUB-68511-91110	I-U-10	30 X 55 mm	32.86
KUB-68511-91120	I-U-10	35 X 70 mm	35.58
KUB-68541-91010	I-U-10	40 X 80 mm	161.39
KUB-68581-91020	P-U-10	45 X 90 mm	73.47
KUB-68581-91030	P-U-10	45 X 80 mm	75.53
KUB-68651-91020	P-U-10	45 X 90 mm	46.78
KUB-68651-91030	P-U-10	45 X 80 mm	82.97

Kit Number	Code (Pg. x)	Rod X Bore Size	List Price
KUB-68721-91110	I-U-5	30 X 50 mm	\$ 26.50
KUB-68721-91130	I-U-10	45 X 80 mm	32.13
KUB-68721-91160	I-U-10	35 X 65 mm	55.58
KUB-68741-91010	P-UB-10	45 X 70 mm	88.28
KUB-68741-91020	P-U-10	40 X 80 mm	44.46
KUB-68761-91040	P-UB-10	45 X 70 mm	77.59
KUB-68761-91050	P-UB-10	45 X 90 mm	91.84
KUB-68761-91060	P-U-10	40 X 70 mm	37.82
KUB-68761-91120	P-U-10	45 X 90 mm	201.34
KUB-68761-91130	P-UB-10	45 X 80 mm	174.65
KUB-68761-91150	P-UB-10	45 X 90 mm	197.36
KUB-68811-93070	P-UB-10	40 X 70 mm	93.98
KUB-68861-93300	P-U-10	40 X 70 mm	71.45
KUB-69521-91110	P-U-10	30 X 55 mm	37.69
KUB-69521-91130	P-U-10	30 X 55 mm	37.91
KUB-RB101-91020	P-U-10	30 X 55 mm	56.83
KUB-RB201-91010	P-U-10	30 X 55 mm	40.20
KUB-RB201-91030	P-U-10	35 X 70 mm	40.20
KUB-RB201-91050	P-U-10	35 X 60 mm	56.95



LEACH

Kit Number	Cylinder	Code (Pg. x)	Rod X Bore Size	List Price
LCH-10035		I-U-5	4 X 6	\$ 36.46
LCH-101102	300600	P-U-5	2-1/4 X 4	26.21
LCH-101103	401054	I-U-10	3-1/2 X 5	36.49
LCH-101238		I-N-4	1-3/4 X 6	44.64
LCH-102168	401207	I-U-5	2 X 4	23.86
LCH-102169		I-U-13	3-1/2 X 5	56.53
LCH-102559		I-U-4	2 X 5	33.97
LCH-102565	2RII T.G. LIFT	I-U-4	2-1/4 X 4	24.34
LCH-102566	402161, 402162	P-N-4	2-1/4 X 4	21.55
LCH-102567	402314, 402315	P-U-4	2-1/4 X 4	29.51
LCH-103945	2-3/8, 2-7/8, 3-3/8, 3-7/8 Stages			42.81
LCH-15452	15026	P-U-5	2-1/4 X 6	51.41
LCH-15452U	15026	P-U-5	2-1/4 X 6	62.92
LCH-15453	15074	P-N-6	2-1/4 X 4	29.16
LCH-15454	15049	I-U-4	2 X 5	38.01
LCH-15454U	15049	I-U-4	2 X 5	48.97
LCH-15468	15373	P-U-5	2-1/4 X 4	34.15
LCH-15468U	15373	P-U-5	2-1/4 X 4	51.93
LCH-2R1054	2R1054	I-U-5	4 X 6	36.08
LCH-2R2008K	2R1008	I-V-7	4-1/2 X 6	50.88
LCH-2R2114	2R1006	I-V-7	4-1/2 X 6	75.12
LCH-2R2114A	2R1006A, 2R1008A	I-U-5	4-1/2 X 6	59.15
LCH-2R2114AU	2R1006A, 2R1008A	I-U-5	4-1/2 X 6	41.84
LCH-30653	18974,18975, 31201, 32327, 37306	I-U-5	2 X 4	25.48
LCH-30654	17001	I-U-5	2 X 5	60.92
LCH-33557		I-U-5	2-1/4 X 5	43.76
LCH-33558	31778	P-U-5	2-1/4 X 4	41.42
LCH-36363		I-U-10	2-1/4 X 3-1/2	25.51
LCH-950051	4, 5, 6 - Wipers, U-seals, Bearings			167.48
LCH-P16-541	P16-273	P-V-7	2-1/4 X 4	46.18
LCH-P16-569	P16-204	P-N-6	2-1/4 X 3	23.28
LCH-P16-570	P16-7	N-N-6	4" BORE	19.32
LCH-P16-934K	P16-934	P-U-6	2-1/4 X 4	37.38
LCH-P16-934KU		P-U-6	2-1/2 X 4	46.36
LCH-P25-29K	P25-29	I-U-5	3 X 6	38.35
LCH-PO1148	PO-1166	N-V-7	4-1/2 X 6	66.80
LCH-PO-1567	PO-265	I-O-6	2-1/4 X 4	28.43
LCH-SR7145	Valve Kit 2R1696			10.41
LCH-SR7158	SR6002	I-OB-7	2 X 5	47.68
LCH-SR7162		P-V-7	2-1/4 X 6	66.94
LCH-SR9002	SR6021	P-V-7	2-1/4 X 6	51.41
LCH-U1291D	U1158, 15527	P-U-5	2-1/4 X 6	57.62
LCH-U1291DU		P-U-5	2-1/4 X 6	67.71

LIEBHERR

Kit Number	Code (Pg. x)	Rod X Bore Size	List Price
LBH-13017-J-1	I-U-10,12	6, 9 X 8, 10-1/2	\$ 1,620.11
LBH-13017-K-1	I-U-10,11	7-1/2,11 X 10,13	728.86
LBH-13029-C-1	P-U-10	2-3/4 X 5-1/2	47.71
LBH-51784-M-1	I-U-1	12" Rod Kit	660.41
LBH-51784-N-1	I-U-1	12" Rod Kit	660.41
LBH-5708-876-08	N-N-15	160mm Piston	136.15
LBH-9063464	N-N-10	70 mm Piston Kit	32.79
LBH-9155154	I-SP-1	50 mm Rod Kit	208.30
LBH-9165363	N-N-10	140mm Piston	224.72
LBH-9165440	N-N-10	150mm Piston	241.15
LBH-9165441	I-BB-1	100 mm	140.39
LBH-9169653	N-N-10	170mm Piston	279.59
LBH-9169654	N-N-10	180mm Piston	315.88
LBH-9170257	N-N-10	200mm Piston	328.60
LBH-9374710	I-U-15	140 X 160 mm	190.68

LINK BELT

Kit Number	Code (Pg. x)	Rod X Bore Size	List Price
LB-LQU-0008	P-UB-10	100 X 150 mm	\$ 268.43
LB-LQU-0009	P-UB-10	110 X 160 mm	284.62
LB-LQU-0010	P-UB-10	95 X 140 mm	183.65
LB-LQU-0011	P-UB-10	70 X 110 mm	180.06
LB-LQU-0012	P-UB-10	85 X 125 mm	210.05
LB-LQU-0015	P-UB-10	70 X 110 mm	163.25
LB-LQU-0017	P-UB-14	110 X 160 mm	269.98
LB-LQU-0020	P-UB-10	85 X 125 mm	202.08
LB-LQU-0021	P-UB-10	100 X 140 mm	253.65
LB-LQU-0022	P-UB-10	80 X 120 mm	210.36
LB-LQU-0028	P-UB-10	90 X 140 mm	236.58
LB-LQU-0029	P-UB-10	105 X 150 mm	271.57
LB-LQU-0030	P-UB-10	90 X 130 mm	210.36
LB-LQU-0037	P-UB-10	85 X 130 mm	197.50



LOADMASTER

Kit Number	Code (Pg. x)	Rod X Bore Size	List Price
LM-150129	P-U-10	2-1/2 X 5-1/4	\$ 42.80
LM-157615	I-U-5	2-1/2 X 4-1/4	53.40
LM-15762	I-U-1	4-3/4 X 5-1/2	50.06
LM-157625	I-U-1	4-3/4 X 5-1/2	43.98
LM-15768	I-U-5	2-1/2 X 5-1/4	79.71
LM-157685	I-U-5	2-1/2 X 5-1/4	76.62
LM-157775	I-U-5	2-1/4 X 4-1/4	54.66
LM-157785	I-U-5	2-1/2 X 5-1/2	75.37
LM-157845	I-U-5	2-1/2 X 4-3/4	72.68
LM-158725	I-U-5	2-1/2 X 7-1/4	111.29
LM-20663	I-U-5	3-1/2 X 5-1/2	82.19
LM-24861	I-U-5	2-1/2 X 5-1/2	83.04
LM-24862	I-U-5	2-1/2 X 5-1/2	82.19
LM-750006K	I-U-1	4-3/4 X 5-1/2	30.69
LM-750008-10	I-U-5	2-1/2 X 4-1/4	37.39
LM-750008-K	I-U-5	2-1/2 X 4-1/4	35.97
LM-750010K	I-U-5	2-1/2 X 5-1/2	50.98
LM-750011-10	I-U-5	2-1/2 X 5-1/4	46.61
LM-750012K	I-U-5	2-1/2 X 7-1/4	78.84
LM-750013K	I-U-5	1-1/2 X 4-1/4	36.11
LM-750094K	I-U-5	2-1/2 X 4-3/4	54.79
LM-750182K	I-U-5	2-1/2 X 5-1/2	47.00

LOG HOG

Kit Number	Code (Pg. x)	Rod X Bore Size	List Price
LGH-28-04-30	I-U-3	1-1/2 X 3	\$ 14.52
LGH-37-06-05	I-U-3	1-1/2 X 3-1/2	9.09
LGH-37-06-05-HD	I-U-3	1-1/2 X 3-1/2	10.82
LGH-37-06-06	I-N-4	1-3/4 X 5	14.60
LGH-37-06-06-HD	I-N-4	1-3/4 X 5	23.18
LGH-37-06-07	I-U-5	2 X 5	32.34
LGH-37-06-08	I-U-5	2-1/2 X 6	40.51
LGH-37-06-08-HD	I-U-5	2-1/2 X 6	75.31
LGH-37-07-13	I-U-5	3 X 6	46.81
LGH-37-07-13-HD	I-U-5	3 X 6	76.86
LGH-37-07-29	I-N-4	2-1/2 X 6	17.26
LGH-37-07-29-HD	I-N-4	2-1/2 X 6	33.08
LGH-37-12-54	I-U-5	1-1/2 X 3-1/2	18.55
LGH-37-12-54-HD	I-U-5	1-1/2 X 3-1/2	32.66
LGH-37-12-59	I-U-5	1-3/4 X 4	24.18

LOG HOG

Kit Number	Code (Pg. x)	Rod X Bore Size	List Price
LGH-37-12-59-HD	I-U-5	1-3/4 X 4	\$ 39.76
LGH-37-14-47	I-U-5	2-1/2 X 5	34.20
LGH-37-14-47-HD	I-U-5	2-1/2 X 5	52.87
LGH-37-17-48	I-N-4	3 X 7	23.19
LGH-37-17-48-HD	I-N-4	3 X 7	48.61
LGH-37-17-49	I-U-5	3-1/2 X 7	58.26
LGH-37-17-49-HD	I-U-5	3-1/2 X 7	110.43
LGH-37-17-50	I-U-5	3 X 7	54.47
LGH-37-17-50-HD	I-U-5	3 X 7	106.67
LGH-37-21-05	P-N-4	1-3/4 X 5	18.74
LGH-37-21-05-HD	P-N-4	1-3/4 X 5	24.97
LGH-37-53-34	I-U-5	1-3/4 X 4	39.63
LGH-37-53-52	I-U-5	3-1/2 X 7	55.16
LGH-37-53-52-HD	I-U-5	3-1/2 X 7	111.06
LGH-37-53-53-HD	I-U-5	1-1/2 X 3-1/2	32.84
LGH-37-53-54	I-U-5	3 X 7	57.21
LGH-37-53-54-HD	I-U-5	3 X 7	109.45
LGH-37-53-88	I-U-5	3 X 6	49.28
LGH-37-53-88-HD	I-U-5	3 X 6	79.33
LGH-37-68-68	5" Swivel Kit		60.73
LGH-37-72-98	I-U-5	3 X 5	41.67
LGH-37-72-98-HD	I-U-5	3 X 5	56.21
LGH-37-73-06	I-U-5	3 X 6	41.83
LGH-37-73-06-HD	I-U-5	3 X 6	79.39
LGH-37-75-43-HD	I-U-5	3 X 6	82.74
LGH-37-75-47	I-U-5	4 X 7	98.95
LGH-37-75-47-HD	I-U-5	4 X 7	115.08
LGH-37-90-77-HD	P-U-10	3-1/2 X 7	67.65
LGH-37-90-79	P-U-10	3 X 6	41.31
LGH-37-90-79-HD	P-U-10	3 X 6	46.75
LGH-37-90-80-HD	I-U-10	2-1/2 X 5	31.23
LGH-37-97-15	6 -1/2" Swivel Kit		92.07
LGH-38-11-44	I-U-10	3 X 6	88.51



LORAIN

Kit Number	Code (Pg. x)	Rod X Bore Size	List Price
LOR-1103	I-N-10	4-1/4 X 6	\$ 31.73
LOR-1103U	I-U-10	4-1/4 X 6	43.58
LOR-1139	I-U-10	3/4 , 1-1/2 X 2-1/2	21.83
LOR-1179	I-U-10	1-1/2 X 2-1/2	11.73
LOR-1191	O-Ring Kit		6.11
LOR-201521	P-U-10	3-1/2 X 5	43.32
LOR-201778	P-U-10	4 X 6	44.37
LOR-23699	P-U-3	2 X 3-1/2	16.66
LOR-28687	I-N-10	4 X 5	23.34
LOR-28696	I-OB-10	1-1/2 X 2	7.28
LOR-80187	I-U-10	3 X 4	27.72
LOR-963A	I-U-12	7 X 8-1/8	170.78
LOR-983-C	I-U-10, 12	4-1/2 X 8-1/8	172.31

LUCKY LOADER

Kit Number	Code (Pg. x)	Rod X Bore Size	List Price
LK-GL400-1000-250A	I-U-5	2-1/2 X 4	\$ 45.57
LK-GL700-3000-400	I-U-5	4 X 7	49.59
LK-L400-800-200	I-U-5	2 X 4	33.52
LK-L700-3600-400-A3	I-U-5	4 X 7	130.22
LK-TL600-2087-250	I-U-5	2-1/2 X 6	35.12
LK-TL600-2087-300	I-U-5	3 X 6	46.99

LULL

Kit Number	Code (Pg. x)	Rod X Bore Size	List Price
LULL-3586-34	I-U-10	1-1/8 X 3	\$ 18.73
LULL-P19382	I-U-10	1-1/8 X 2-1/2	10.95

MAILHOT TELESCOPIC CYLINDERS

Kit Number	Cylinder Number	Description	Stage I.D.	List Price
MH-009-SK	M134-6-3	3 stage, U-Seals & Keepers	4, 5, 6	\$ 200.65
MH-078-SK	M150-6-4	4 Stage, U-Seals & Keepers	3-1/4, 4, 5, 6	367.94
MH-119-SK	M130-5.5-3	3 Stage, U-Seals & Keepers	3-1/2, 4-1/2, 5-1/2	185.56
MH-124-SK	M150-6.5-4	4 Stage, U-Seals & Keepers	3-1/2, 4-1/2, 5-1/2, 6-1/2	274.67
MH-125-SK	M160-6.5-4	4 Stage, U-Seals & Keepers	3-1/2, 4-1/2, 5-1/2, 6-1/2	274.67
MH-9000025-SK	C190-8-5	5 Stage, Z-Seals & Wipers	4, 5, 6, 7, 8	213.94
MH-9000030-SK	C200-8-5	5 Stage, Z-Seals & Wipers	4, 5, 6, 7, 8	213.94
MH-9000034-SK	C135-7-4, C162-7-4	4 Stage, Z-Seals & Wipers	4, 5, 6, 7	152.67
MH-9000035-SK	C111-7-3	3 Stage, Z-Seals & Wipers	5, 6, 7	127.56



KINGSEAL CO., LTD. THAILAND

46/152-153 Moo 3 Sri Saman Road
 Baan Mai Pakkret, Nonthaburi Thailand 11120

Tel: +662 9617534 to 6

Fax: +662 9617540

Email: intlsales@kingseal.co.th / kingsealmail@gmail.com

Website: <http://www.kingseal.co.th>

MARION TELESCOPIC CYLINDERS

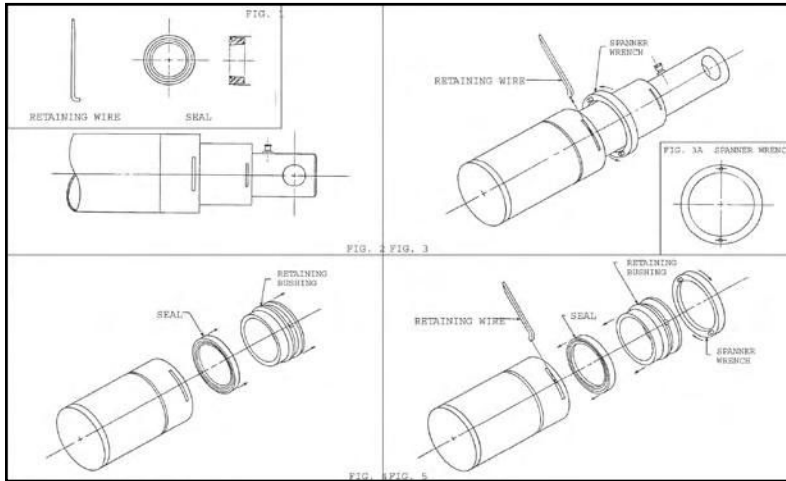

INSTRUCTIONS:

Remove cylinder and lie flat with sides parallel to ground. Drain oil from cylinder leaving stages slightly extended as shown in FIG. 2, exposing retaining wire slots. Using spanner wrench (FIG. 3A) or equivalent, remove retaining wire by turning retaining bushing counter-clockwise (FIG.3). After retaining wire is out, remove retaining bushing and seal, FIG. 4. Replace with seal provided in kit, FIG. 1. Retaining bushing (FIG. 5) and secure with retaining wire (FIG.1). Repeat steps for all other stages and other tubes.

Part Number	Stage Size	I.D.	O.D.	Height	List Price
STAGE BEARINGS					
MARION-35120	1-7/8	1-7/8	2-1/4	1	\$ 9.65
MARION-35130	2-3/4	2-3/4	3-1/4	1	11.96
MARION-35140	3-3/4	3-3/4	4-1/4	1	12.73
MARION-35150	4-3/4	4-3/4	5-1/4	1	13.74
MARION-35160	5-3/4	5-3/4	6-1/4	1	14.51
WIPERS					
MARION-35731	2-3/4	2-3/4	3.114	.122	\$ 1.76
MARION-35741	3-3/4	3-3/4	3.996	.11	4.36
MARION-35751	4-3/4	4-3/4	4.996	.11	4.54
MARION-35761	5-3/4	5-3/4	5.996	.11	4.63
MARION-35771	6-3/4	6-3/4	6.996	.11	4.67
PISTON BEARINGS					
MARION-35420	2	1-7/8	2-1/4	1/2	\$ 2.66
MARION-35430	3	2-3/4	3-1/4	1/2	2.79
MARION-35440	4	3-3/4	4-1/4	1/2	2.94
MARION-35450	5	4-3/4	5-1/4	1/2	3.01
MARION-35460	6	5-3/4	6-1/4	1/2	3.95

Part Number	Stage Size	Length	Square C/S	List Price
RETAINING WIRE				
MARION-35240	2-3/4	10-1/4	1/8	\$ 5.68
MARION-35250	3-3/4	13-3/8	1/8	6.02
MARION-35260	4-3/4	16-3/8	1/8	6.52
MARION-35270	5-3/4	19-1/4	1/8	6.64

COMPLETE REPAIR KITS			
Part Number	Series	Stage Sizes	List Price
Kits contain rod seals and retaining wire for each stage			
MARION-35704	32 series	1-7/8, 2-3/4	\$ 24.61
MARION-35705	42 series	2-3/4, 3-3/4	30.73
MARION-35706	43 series	1-7/8, 2-3/4, 3-3/4	40.87
MARION-35707	53 series	2-3/4, 3-3/4, 4-3/4	51.57
Kits contain rod seals, wipers and retaining wire for each stage			
MARION-35708	63 series	3-3/4, 4-3/4, 5-3/4	\$ 76.80
MARION-35709	64 series	2-3/4, 3-3/4, 4-3/4, 5-3/4	90.34
MARION-35715	62 series	4-3/4, 5-3/4	58.18
MARION-35716	52 series	3-3/4, 4-3/4	46.00



MARK HI-LIFT

Kit Number	Code (Pg. x)	Rod X Bore Size	List Price	Kit Number	Code (Pg. x)	Rod X Bore Size	List Price
ML-16963		Valve Kit	\$ 5.28	ML-66502	I-U-10	2-1/2 X 5	\$ 51.76
ML-20042	I-U-3	7/8 X 1-1/2	8.13	ML-66548	I-U-3	1 X 2	11.73
ML-20127	I-U-5	2-1/2 X 3-1/2	30.61	ML-66563	I-U-3	1-1/4 X 3-1/2	18.68
ML-20128	I-U-5	1-1/4 X 3-1/2	31.01	ML-66651	I-U-3	1-3/8 X 2-1/2	8.99
ML-244-A	I-OB-2	1 X 2	11.94	ML-66657	I-U-1	4-1/2" ROD	23.34
ML-3009A	I-OB-3	1-1/2 X 3-1/2	6.29	ML-66721	I-U-10	3-1/2 X 6	65.48
ML-3011-A	I-OB-3	1-1/2 X 3-1/2	6.55	ML-66806	Valve Kit		26.11
ML-3012-1	I-OB-3	1-1/4 X 2	4.39	ML-66818	2 Stage	3-1/2, 4-1/2	34.07
ML-3062-1	I-OB-3	3/4 X 1-1/2	6.74	ML-66895	I-U-10	2 X 4-1/2	54.47
ML-3065-A	I-N-3	1-1/2 X 4	5.19	ML-66971	Motor Kit		64.30
ML-66017	I-U-5	2 X 4	47.71	ML-67040	I-U-10	2 X 3-1/2	31.79
ML-66041	I-U-10	1-1/2 X 3-1/2	16.97	ML-67051	I-U-10	1-1/2 X 2-1/2	26.88
ML-66043	I-U-5	3-1/2 X 6	46.34	ML-67150	Valve Kit		14.23
ML-66044	I-U-5	1-3/8 X 2-1/2	21.62	ML-67214	Special		48.30
ML-66045	I-U-5	2 X 3-1/2	29.03	ML-67842	I-U-10	1-1/2 X 2-1/2	15.09
ML-66165	I-U-5	2 X 5	51.06	ML-67843	I-U-13	1 X 2	11.44
ML-66226	I-U-10	1-1/2 X 3	14.09	ML-67845	I-U-1	3-1/2 X 4	22.02
ML-66227	I-U-10, 12	2-1/2 X 3-1/2	30.08	ML-68518	P-O-1	7/16 SHAFT KIT	4.31
ML-66363	I-U-10, 12	2-3/4 X 3-3/4	40.25	ML-68948	I-U-11	3/4 X 2	14.29

MASSEY FERGUSON

Replacement Kits For

Loaders						
APPLICATION	CYL #	CODE	ROD	BORE	KIT #	List \$
MODEL 50H						
ARM	1605081M94	P-U-10	2	4-1/4	MF-1607730M91	129.46
BOOM	1605245M91	P-U-8	2	4-1/4	MF-1607427M91	139.72
BUCKET TILT	1605045M93	P-U-10	40 mm	2-1/2	MF-1606502M94	47.24
STABILIZER	1605174M92	P-U-10	2	3-1/2	MF-1607915M92	130.18
SWING	1605262M91	P-U-14	40 mm	75 mm	MF-3402545M91	78.06
MODEL 250						
LIFT		P-U-10	45 mm	65 mm	MF-3443575M93	90.10
		P-U-10	45 mm	75 mm	MF-1606583M93	89.57

Kit Number	Code (Pg. x)	Rod X Bore Size	List Price
MF-1606487M93	I-U-10	2-1/4 x 3	\$ 23.18
MF-1606502M94	P-U-10	40 mm X 2-1/2"	47.24
MF-1606583M93	P-U-10	45 X 75 mm	89.57
MF-1606681M92	O-RING KIT		6.15
MF-1607427M91	P-U-8	2 X 4-1/4	139.72
MF-1607730M91	P-U-10	2 X 4-1/4	129.46
MF-1607915M92	P-U-10	2 X 3-1/2	130.18
MF-1609031M93	I-U-10	1-3/4 X 2-1/4	28.86
MF-3402545M91	P-U-14	40 X 75 mm	78.06

Kit Number	Code (Pg. x)	Rod X Bore Size	List Price
MF-3443575M93	P-U-10	40 X 65 mm	\$ 90.10
MF-3484947M93	P-U-10	35 X 65 mm	71.02
MF-3484955M92	P-U-10	50 X 70 mm	112.89
MF-3485221M93	P-U-10	40 X 75 mm	95.63
MF-3485304M92	P-U-10	35 X 70 mm	90.86
MF-3485427M92	P-U-10	45 X 80 mm	121.77
MF-704643M91	P-OB-3	1-1/4 X 2-1/2	17.82
MF-836994M91	P-U-10	2 X 4	67.51

MEYER PRODUCTS

Kit Number	Code (Pg. x)	Rod X Bore Size	List Price
MY-15254	P-O-6	1-1/8 X 1-3/4	\$ 9.99
MY-15456	P-OB-6	1-1/8 X 1-3/4	13.92

Kit Number	Code (Pg. x)	Rod X Bore Size	List Price
MY-15707	P-U-6	1-1/8 X 1-3/4	\$ 25.73
MY-7705	I-V-1	1-1/2" ROD	9.99

MITSUBISHI

Replacement Kits For

Excavators

APPLICATION	CYL #	CODE	ROD	BORE	KIT #	List \$
MODEL MS-110-5, MS-110L-5, MS-110D-5, MS-110S-5						
ARM	C25320004	P-UB-15	80 mm	120 mm	MIT-C75300020	182.90
	C25320005	P-UB-15	80 mm	120 mm	MIT-C75300020	182.90
BOOM	C25300104	P-UB-15	70 mm	110 mm	MIT-C75300010	168.93
	C25340004	P-UB-15	65 mm	110 mm	MIT-C75300030	166.95
BUCKET	C25340005	P-UB-15	65 mm	110 mm	MIT-C75300030	166.95
MODEL MS-120-2, MS-120S-2, MS-120SS-2						
ARM	C65320002	P-UB-14	80 mm	120 mm	MIT-C65300022	214.32
	C65320003	P-UB-14	80 mm	120 mm	MIT-C65300022	214.32
	C65320004	P-UB-14	80 mm	120 mm	MIT-C65300022	214.32
BOOM	C65300102	P-UB-14	75 mm	110 mm	MIT-C65300012	234.97
	C65300103	P-UB-14	75 mm	110 mm	MIT-C65300012	234.97
BUCKET	C65300104	P-UB-14	75 mm	110 mm	MIT-C65300012	234.97
	C65340003	P-UB-14	70 mm	110 mm	MIT-C65300032	224.70
	C65340004	P-UB-14	70 mm	110 mm	MIT-C65300032	224.70
	C65340005	P-UB-14	70 mm	110 mm	MIT-C65300032	224.70
MODEL MS-180-3, MS-180S-3, MS-180LC-3						
ARM	E35300201	P-UB-5	90 mm	130 mm	MIT-E15300023	208.44
BOOM	E35300101	P-UB-5	85 mm	125 mm	MIT-E15300013	198.60
BUCKET	E35300301	P-UB-5	75 mm	120 mm	MIT-E15300033	175.98
MODEL MS-180-8						
ARM	E75300301	P-UB-10	100 mm	140 mm	MIT-E75300010	263.78
BOOM	E75300101	P-UB-10	85 mm	125 mm	MIT-E35300040	221.00
	E75300201	P-UB-10	85 mm	125 mm	MIT-E35300040	221.00
BUCKET	E75300401	P-UB-10	85 mm	125 mm	MIT-E35300040	221.00

REPLACEMENT KITS FOR MITSUBISHI EQUIPMENT

Kit Number	Code (Pg. x)	Rod X Bore Size	List Price
MIT-C65300012	P-UB-14	75 X 110 mm	\$ 234.97
MIT-C65300022	P-UB-14	80 X 120 mm	214.32
MIT-C65300032	P-UB-14	70 X 110 mm	224.70
MIT-C75300010	P-UB-15	70 X 110 mm	168.93
MIT-C75300020	P-UB-15	80 X 120 mm	182.90
MIT-C75300030	P-UB-15	65 X 110 mm	166.95
MIT-E15300013	P-UB-5	85 X 125 mm	198.60

Kit Number	Code (Pg. x)	Rod X Bore Size	List Price
MIT-E15300023	P-UB-5	90 X 130 mm	\$ 208.44
MIT-E15300033	P-UB-5	75 X 120 mm	175.98
MIT-E25300061	P-UB-14	90 X 140 mm	290.43
MIT-E35300040	P-UB-10	85 X 125 mm	221.00
MIT-E75300010	P-UB-10	100 X 140 mm	263.78
MIT-F15300011	P-UB-14	100 X 150 mm	199.42

REPLACEMENT PARTS FOR MITSUBISHI EQUIPMENT

NOTE: Mitsubishi part numbers are used as a reference only. We do not imply that these kits are original REPLACEMENT PARTS.

WIPERS

Part Number	Rod Dia.	List Price
MIT-05566-13030	30 mm	\$ 11.19
MIT-05566-13530	35 mm	11.80
MIT-64374-79200	40 mm	14.42
MIT-A04500812	50 mm	15.85
MIT-A04501417	65 mm	21.69
MIT-A04500815	70 mm	23.27
MIT-A04500822	70 mm	23.27
MIT-A04501418	70 mm	23.27
MIT-C45300148	75 mm	25.03
MIT-E35300325	75 mm	25.03
MIT-1853252	80 mm	5.90
MIT-A04500817	80 mm	29.50
MIT-A04501420	80 mm	29.50
MIT-E15300392	85 mm	33.49
MIT-E35300127	85 mm	33.49
MIT-1853094	90 mm	36.21
MIT-A04501422	90 mm	36.21
MIT-F25340118	90 mm	36.21
MIT-E85300320	95 mm	37.03
MIT-1853143	100 mm	38.01
MIT-A04501423	100 mm	38.01
MIT-F15302319	100 mm	12.21
MIT-F25340058	100 mm	38.01
MIT-A04903618	110 mm	38.93

ROD U-SEALS

Part Number	Rod Dia.	List Price
MIT-91254-06600	22 mm	\$ 6.02
MIT-A04600911	45 mm	8.11
MIT-A04600912	50 mm	11.07
MIT-A04600914	65 mm	12.94
MIT-A04600915	70 mm	12.72
MIT-A04700415	70 mm	6.43
MIT-7953042	75 mm	16.72
MIT-A04600918	75 mm	15.47
MIT-C45300134	75 mm	6.43
MIT-E35302115	75 mm	15.21

ROD U-SEALS

Part Number	Rod Dia.	List Price
MIT-E35302116	75 mm	\$ 6.43
MIT-1853083	80 mm	18.39
MIT-A04600917	80 mm	16.92
MIT-A04700417	80 mm	7.75
MIT-48-7953142	85 mm	19.03
MIT-7953142	85 mm	19.03
MIT-E15301215	85 mm	7.75
MIT-E35301915	85 mm	18.39
MIT-E35301916	85 mm	7.75
MIT-1853057	90 mm	20.41
MIT-1853239	90 mm	20.41
MIT-A04600925	90 mm	19.58
MIT-A04700423	90 mm	7.75
MIT-E15301116	90 mm	7.75
MIT-E85300317	95 mm	20.66
MIT-E85300318	95 mm	7.75
MIT-1853136	100 mm	22.41
MIT-A04600926	100 mm	15.65
MIT-A04700424	100 mm	9.03
MIT-94319-02400	112 mm	23.46

PISTON U-SEALS

Part Number	Bore Dia.	List Price
MIT-05565-07010	70 mm	\$ 15.90
MIT-A04601211	70 mm	59.36
MIT-05565-08010	80 mm	18.02
MIT-A04601213	90 mm	69.25
MIT-A04601215	110 mm	89.04
MIT-A04601311	110 mm	40.22
MIT-E85300439	115 mm	31.35
MIT-A04601216	120 mm	89.04
MIT-A04601312	120 mm	41.91
MIT-C45300229	120 mm	34.19
MIT-E85300137	120 mm	31.35
MIT-E153-00386	125 mm	37.10
MIT-E35301920	125 mm	32.26

PISTON U-SEALS

Part Number	Bore Dia.	List Price
MIT-2153243	130 mm	\$ 37.10
MIT-E85300347	130 mm	32.44
MIT-4653414	140 mm	42.78
MIT-A04601314	140 mm	57.02
MIT-E75300322	140 mm	37.04
MIT-1853063	150 mm	47.70
MIT-A04601315	150 mm	62.02
MIT-4653514	160 mm	51.41
MIT-A04601719	160 mm	70.45

BUFFER RINGS

Part Number	Rod Dia.	List Price
MIT-05566-03520	35 mm	\$ 2.77
MIT-A04600815	50 mm	6.40
MIT-A04600811	65 mm	7.49
MIT-A04601014	65 mm	21.02
MIT-A04600812	70 mm	8.46
MIT-A04601015	70 mm	22.94
MIT-A04601016	75 mm	24.39
MIT-E15302312	75 mm	23.07
MIT-E85300437	75 mm	20.43
MIT-A04600813	80 mm	9.41
MIT-A04601017	80 mm	25.83
MIT-E15300372	85 mm	28.54
MIT-E85300140	85 mm	22.82
MIT-A04601024	90 mm	29.16
MIT-E85300344	95 mm	25.25
MIT-A04601025	100 mm	30.92
MIT-F15302316	100 mm	30.92
MIT-A04601018	110 mm	39.20



REPLACEMENT PARTS FOR MITSUBISHI EQUIPMENT

NOTE: Mitsubishi part numbers are used as a reference only. We do not imply that these kits are original REPLACEMENT PARTS.

WEAR RINGS

Part Number	O.D. X Width	List Price
MIT-E85300345	100 X 9.7 mm	\$ 15.72
MIT-A04903612	110 X 6 mm	11.76
MIT-E85300420	115 X 6 mm	11.76
MIT-E85300440	115 X 7.9 mm	7.53
MIT-A04901912	120 X 30 mm	17.11
MIT-A04903613	120 X 6 mm	11.76
MIT-E85300136	120 X 7.9 mm	8.10
MIT-E85300120	120 X 8 mm	24.05
MIT-E35301921	125 X 8 mm	24.05
MIT-E85300326	130 X 7.9 mm	9.03
MIT-E85300438	130 X 8 mm	24.05
MIT-A04901915	140 X 40 mm	27.91
MIT-A04903616	140 X 8 mm	24.05
MIT-E75300323	140 X 8 mm	24.05
MIT-A04901916	150 X 40 mm	27.11
MIT-A04903617	150 X 8 mm	24.05

BACK-UP RINGS

Part Number	Min Pkg Qty	List Price
MIT-05568-90700	1	\$ 4.83
MIT-05568-90800	1	4.89
MIT-4653425	1	7.80
MIT-4653623	1	7.18
MIT-4753177	1	13.57
MIT-94153-07300	1	5.33
MIT-A04700312	1	6.59
MIT-A04700313	1	12.20
MIT-A04700314	1	4.83
MIT-A04700315	1	5.23
MIT-A04700324	1	7.80
MIT-A04700325	1	6.69
MIT-E15301130	1	7.11
MIT-E15302093	1	4.89
MIT-E25310020	1	6.69

BACK-UP RINGS

Part Number	Min Pkg Qty	List Price
MIT-E35300217	1	\$ 7.18
MIT-E35300315	1	12.20
MIT-E35301917	1	5.00
MIT-E35302130	1	5.00
MIT-E75300317	1	14.33
MIT-E75300318	1	5.19
MIT-E85300321	1	7.16
MIT-E85300416	1	4.89
MIT-F15300921	1	7.80
MIT-F15301418	1	7.80

O-RINGS

Part Number	Min Pkg Qty	List Price
MIT-2153222	2	\$ 4.22
MIT-4753176	2	4.18
MIT-7953122	2	4.22
MIT-91254-06300	20	.30
MIT-94004-00900	5	1.38
MIT-F3150-04900	7	.78
MIT-F3150-06000	5	1.91
MIT-F3150-07000	4	2.43
MIT-F3153-04000	10	.53
MIT-F3153-05000	10	.66
MIT-Z440101000	3	2.97
MIT-Z440101100	3	3.86
MIT-Z440200600	5	1.91
MIT-Z440201100	3	3.86
MIT-Z440201150	2	3.93
MIT-Z440201200	2	4.01
MIT-Z440201250	2	4.08
MIT-Z440201300	2	4.09
MIT-Z440201400	2	4.22
MIT-Z440201500	2	5.11

O-RINGS

Part Number	Min Pkg Qty	List Price
MIT-Z440201550	1	\$ 7.38
MIT-Z441001150	3	2.31
MIT-Z441101000	4	1.76
MIT-Z441101100	3	2.24
MIT-Z441101150	3	2.14
MIT-Z441101200	3	2.22
MIT-Z441101250	3	2.24
MIT-Z441101300	3	2.29
MIT-Z441101450	2	2.62
MIT-Z441101600	1	7.48

O-RINGS 90 DUROMETER

Part Number	Min Pkg Qty	List Price
MIT-Z440200800	3	\$ 2.78
MIT-Z441001150	3	2.31
MIT-Z441101050	3	2.14



MITSUBISHI LIFT TRUCKS

Kit Number	Code (Pg. x)	Rod X Bore Size	List Price
MIT-91254-10330	P-U-10	22 X 45mm	\$ 31.73
MIT-91254-30330	P-U-10	22 X 45mm	27.95
MIT-91255-11120	I-U-10	22.4 X 45 mm	28.22
MIT-91273-30150	Valve Kit		4.01
MIT-91273-30220	Valve Kit		3.92
MIT-91854-15310	I-U-10	25 X 55 mm	25.44
MIT-91854-40230	P-U-10	25 X 55 mm	32.86
MIT-91872-22120	Valve Kit		5.83
MIT-94004-00120	P-UB-1	30 mm Rod Kit	25.97
MIT-94004-00130	N-N-15	63 mm Piston Kit	40.13
MIT-94104-00110	N-N-13	70 mm Piston Kit	50.27
MIT-94104-00120	P-UB-1	35 mm Rod Kit for 70 mm Bore	27.25
MIT-94104-00170	I-U-10	30 X 63 mm	36.44
MIT-94114-00110	I-U-4	50 X 70 mm	58.50
MIT-94114-00210	I-U-4	60 X 70 mm	69.01
MIT-94119-00018	I-U-1	70 mm Rod Kit	31.10
MIT-94119-00048	I-U-1	50 mm Rod Kit	14.71
MIT-94119-00068	P-U-1	32 mm Rod Kit	26.90
MIT-94119-00088	P-U-1	32 mm	28.58
MIT-94133-00018	I-N-4	40 X 50 mm	46.17
MIT-94151-00018	P-U-1	70 mm Rod Kit	33.02
MIT-94151-00028	P-U-1	70 mm Rod Kit	35.55
MIT-94162-00018	P-U-4	35 X 45 mm	30.50
MIT-94204-10120	I-U-10	35 X 70 mm	17.13
MIT-94219-00018	P-U-1	35 mm Rod Kit	11.18
MIT-94219-00028	P-U-1	35 mm Rod Kit	18.09
MIT-94251-00018	I-U-1	75 mm Rod Kit	32.41
MIT-94251-00038	P-U-1	75 mm Rod Kit	43.10
MIT-94251-00058	P-U-1	75 mm Rod Kit	33.59
MIT-94262-00028	P-U-4	40 X 50 mm	60.10
MIT-94304-00110	N-N-13	80 mm Piston Kit	55.83
MIT-94304-00120	P-UB-1	35 mm Rod Kit for 80 mm Bore	30.73
MIT-94304-10140	I-U-10	35 X 80 mm	24.69
MIT-94314-00110	I-U-1	65 X 80 mm	52.44
MIT-94319-00018	I-U-1	60 mm Rod Kit	17.00
MIT-94319-00038	I-U-1	85 mm Rod Kit	27.58
MIT-94319-00068	P-U-1	40 mm Rod Kit	11.96
MIT-94319-00088	I-U-1	40 mm Rod Kit	38.10
MIT-94351-00018	I-U-1	80 mm Rod Kit	22.63
MIT-94351-00028	P-U-1	45 X 55 mm	69.88

MITSUBISHI LIFT TRUCKS

Kit Number	Code (Pg. x)	Rod X Bore Size	List Price
MIT-94351-00038	P-U-1	85 mm Rod Kit	\$ 45.51
MIT-94351-00068	P-U-1	85 mm Rod Kit	43.01
MIT-94362-00018	P-U-1	45 X 55 mm	69.88
MIT-94404-00120	P-UB-3	45 X 90 mm	40.74
MIT-94404-10140	I-U-10	40 X 80 mm	63.05
MIT-94404-10160	I-U-10	40 X 90 mm	50.68
MIT-94504-02090	P-U-1	40 X 100 mm	33.79

MONARCH ROAD MACHINERY

Kit Number	Code (Pg. x)	Rod X Bore Size	List Price
MRM-5117	I-V-1	1-1/2" ROD	\$ 9.39
MRM-5127	I-V-1	2" ROD	12.16
MRM-5137	I-V-1	2-1/2" ROD	14.11
MRM-5147	I-V-1	3" ROD	16.71
MRM-5157	I-V-1	3-1/2" ROD	21.31
MRM-5385	I-V-7	1-1/2 X 3	26.62
MRM-637405	P-OB-3	1-1/4 X 4	11.87

MORBARK

Kit Number	Code (Pg. x)	Rod X Bore Size	List Price
MB25180-210	I-U-5	2 X 4	\$ 31.33
MB26815-053	P-U-10	1-1/4 X 2-1/2	18.92
MB26815-054	I-U-10	1-1/2 X 3	14.61
MB26815-059	I-U-10	2-1/2 X 5	25.23
MB26815-060	I-U-10	2-1/2 X 5-1/2	31.20
MB26815-061-M	I-U-10	2 X 4	25.91
MB26815-071	I-U-10	3 X 6	50.37
MB26815-071-A	I-U-10	3 X 6	46.49



Replacement Kits For

NEW HOLLAND

NEW HOLLAND

Skid Steer Loaders						
APPLICATION	CYL #	CODE	ROD	BORE	KIT #	List \$
MODEL L454, L455						
BOOM	593204	I-U-10	1-1/4	1-1/2	NH-9610763	12.12
BUCKET	593390	P-U-10	1-1/2	3	NH-9610764	33.76
GRAPPLE	243534	P-U-10	1-1/8	1-1/2	NH-136440	9.61
MODEL L553, L555						
BOOM	592567	I-U-10	1-1/2	1-7/8	NH-782679	21.43
BUCKET	593558	P-U-10	1-1/2	3	NH-9610764	33.76
MODEL L565, LX565, LX665						
BOOM (NEW)	86528677	P-U-10	1-3/8	3	NH-86527694	19.88
BOOM (OLD)	9622429	P-U-10	1-3/8	2-1/2	NH-9801209	37.37
BUCKET (NEW)	86528678	P-U-11	1-1/4	2-1/4	NH-86570919	26.89
BUCKET (OLD)	9622430	P-U-11	1-1/4	2-1/4	NH-86570919	26.89
GRAPPLE	9847007	P-U-10	1	1-1/2	NH-9600405	31.07
MODEL L781, L783, L785						
BOOM	86509051	I-U-10	1-1/2	2	NH-771707	26.19
BUCKET	771699	P-U-10	1-1/8	2-1/4	NH-771700	34.40
	86509051	P-U-10	1-1/8	2-1/4	NH-86509056	13.03
GRAPPLE	243534	P-U-10	1-1/8	1-1/2	NH-136440	9.61
	680101	P-U-10	1-1/8	1-1/2	NH-273412	21.18
SELF LEVELING	264205	P-U-10	1-1/8	2-1/4	NH-219505	26.91
MODEL L865, LX865, L885, LX885						
BOOM	86528680	P-U-11	1-1/2	2-1/2	NH-86570933	38.10
	9845805	P-U-10	1-3/8	2-1/2	NH-9801209	37.37
BUCKET	86528679	P-U-10	1-1/4	2-1/2	NH-9843717	21.94

REPLACEMENT KITS FOR NEW HOLLAND EQUIPMENT

Kit Number	Code (Pg. x)	Rod X Bore Size	List Price
NH-136440	P-OB-10	1-1/8 X 1-1/2	\$ 9.61
NH-219505	P-U-10	1-1/8 X 2-1/4	26.91
NH-273412	P-OB-10	1-1/8 X 1-1/2	21.18
NH-771700	P-U-13	1-1/8 X 2-1/4	34.40
NH-771707	1-U-13	1-1/2 X 2	26.19
NH-782679	1-U-13	1-1/2 X 1-7/8	21.43
NH-85804740	P-UB-10	40 X 80 mm	34.79
NH-86509056	P-U-13	1-1/8 X 2-1/4	13.03

Kit Number	Code (Pg. x)	Rod X Bore Size	List Price
NH-86527694	P-U-13	1-3/8 X 2-1/2	\$ 19.88
NH-86570919	P-U-11	1-1/4 x 2-1/4	26.89
NH-86570933	P-U-11	1-1/2 X 2-1/2	38.10
NH-9600405	P-U-13	1 X 1-1/2	31.07
NH-9610763	1-U-13	1-1/4 X 1-1/2	12.12
NH-9610764	P-U-13	1-1/2 X 3	33.76
NH-9801209	P-U-13	1-3/8 X 2-1/2	37.37
NH-9843717	P-U-13	1-1/4 X 2-1/2	21.94



REPLACEMENT KITS FOR NISSAN LIFT TRUCKS

NOTE: A cylinder number will help in determining the proper kit part number. If no cylinder number is available, furnish rod and bore sizes and description of parts.

Kit Number	Code (Pg. x)	Rod X Bore Size	List Price	Kit Number	Code (Pg. x)	Rod X Bore Size	List Price
NN-49440-00H00	MOTOR KIT		\$ 5.48	NN-58499-02H10	P-U-1	70 mm Rod Kit	\$ 42.42
NN-49510-L6025	P-U-10	25 X 55 mm	43.08	NN-58499-12H11	P-U-1	75 X 85 mm	55.02
NN-49599-11H00	P-U-10	40 X 60 Double Rod	58.47	NN-58499-22H10	P-U-1	90 mm Rod Kit	45.32
NN-49599-51K00	P-U-10	40 X 65 mm	59.00	NN-58499-25H10	P-U-1	80 mm Rod Kit	54.26
NN-58099-00H00	P-U-4	35 X 45 mm	40.67	NN-58499-6G500	I-U-4	2 in X 60 mm	93.46
NN-58099-00H60	P-U-4	35 X 45 mm	28.86	NN-58499-L1100	I-U-1	80 mm Rod Kit	38.89
NN-58099-0G211	I-U-4	2 in X 75 mm	46.29	NN-58499-L1101	I-U-1	50 mm Rod Kit	24.77
NN-58099-0G511	I-U-4	2 in X 80 mm	69.20	NN-58499-L1102	I-U-1	50 mm Rod Kit	26.07
NN-58099-10H00	P-U-5	40 X 50 mm	70.37	NN-58499-L1400	I-U-1	70 mm Rod Kit	33.2
NN-58099-10H60	P-U-4	40 X 50 mm	26.86	NN-58499-L1401	I-U-1	45 mm Rod Kit	23.09
NN-58099-20H12	P-U-4	45 X 60 mm	47.98	NN-58499-L1402	I-U-1	45 mm Rod Kit	24.31
NN-58099-20H62	P-U-4	45 X 60 mm	24.89	NN-58499-L6000	I-U-4	70 X 100 mm	72.04
NN-58099-23H00	P-U-1	45 X 55 mm	34.85	NN-58499-L6001	P-U-1	65mm Rod Kit	40.71
NN-58099-23H60	P-U-4	45 X 55 mm	28.58	NN-58499-L7401	P-U-1	45 mm Rod Kit	19.88
NN-58099-31K11	I-U-4	2" X 2-3/4"	27.09	NN-58699-00H00	P-U-1	25 X 65 mm	36.04
NN-58099-51H10	P-U-14	50 X 70 mm	54.96	NN-58699-05H00	P-U-1	30 X 65 mm	38.02
NN-58099-51H60	P-U-4	50 X 65 mm	25.31	NN-58699-10H00	P-U-3	30 X 70 mm	41.34
NN-58099-51H70	P-U-15	50 X 70 mm	41.49	NN-58699-14H00	P-U-3	35 X 70 mm	42.73
NN-58099-L2600	P-U-4	40 X 50 mm	66.02	NN-58699-20H00	P-U-1	35 X 80 mm	31.87
NN-58099-L4900	P-U-1	55 mm Rod Kit	35.84	NN-58699-21H00	P-U-1	40 X 80 mm	38.53
NN-58099-L6000	P-U-4	50 X 70 mm	81.08	NN-58699-51K00	P-U-3	30 X 60 mm	24.36
NN-58099-L6001	P-U-4	60 X 70 mm	86.54	NN-58699-L1125	I-U-1	35 mm Rod Kit	27.14
NN-58099-L900	P-U-1	55 mm Rod Kit	35.84	NN-58699-L1126	I-U-1	35 mm Rod Kit	28.82
NN-58099-L9010	P-U-15	60 X 80 mm	46.53	NN-58699-L1425	I-U-1	30 mm Rod Kit	28.82
NN-58099-L9016	P-U-15	65 X 80 mm	48.04	NN-58699-L1426	I-U-1	30 mm Rod Kit	25.51
NN-58199-L1100	I-U-4	50 X 70 mm	73.86	NN-58699-L6000	I-U-1	40 mm Rod Kit	29.16
NN-58199-L1300	I-U-4	60 X 80 mm	80.80	NN-58699-L6011	I-U-1	40 mm Rod Kit	31.55
NN-58199-L1400	I-U-4	45 X 65 mm	70.41	NN-58699-L6800	I-U-1	45 mm Rod Kit	32.74
NN-58199-L1700	I-U-4	50 X 70 mm	73.86	NN-58699-L6811	I-U-1	45 mm Rod Kit	35.25
NN-58199-L6000	I-U-4	65 X 90 mm	83.64	NN-58699-L8100	I-U-1	35 X 80 mm	20.22
NN-58199-L6100	I-U-4	70 X 100 mm	86.62	NN-58699-L9000	I-U-1	50mm Rod Kit	33.62
NN-58299-01H00	P-U-1	32 mm Rod Kit	28.94	NN-58699-L9010	I-U-1	50 X 100 mm	40.63
NN-58299-11H00	P-U-1	35 X 55 mm	32.10	NN-69399-90H00		9/16" Valve Kit	4.56
NN-58299-L1100	I-U-1	60, 80, 112mm Stages	59.89	NN-69399-L1202		9/16" Valve Kit	13.58
NN-58399-L1100	I-U-4	60 X 90 mm	82.76				



ORTMAN

Kit Number	Code (Pg. x)	Rod X Bore Size	List Price
ORT-RS003540010	1-U-1	5/8 Rod Kit	\$ 9.75
ORT-RS003540020	1-U-1	1 Rod Kit	9.74
ORT-RS003540040	1-U-1	1-3/4 Rod Kit	18.48
ORT-RS003540060	1-U-1	2-1/2 Rod Kit	20.02
ORT-RS003540090	1-U-1	4" Rod Kit	31.77
ORT-TS563511000	N-N-5	3-1/4 Piston Kit	28.72
ORT-TS583511000	N-N-5	4 Piston Kit	21.79
ORT-TS603511000	N-N-5	6 Piston Kit	57.18
ORT-TS777512000	N-N-5	1-1/2 Piston Kit	6.50

PANDROL-JACKSON

Kit Number	Code (Pg. x)	Rod X Bore Size	List Price
PJ-170217	I-U-4	3 X 6	\$ 47.49
PJ-170225	I-U-5	2 X 4	39.03
PJ-170225-1	I-U-5	2 X 4	39.03
PJ-170233-1	I-U-5	2-1/4 X 3-1/2	35.70
PJ-170452-1	P-U-10	2-1/2 X 3-1/2	48.76
PJ-240237-1	I-U-10	2-3/4 X 4	67.70
PJ-240266-1	P-U10	1 X 2	30.21
PJ-240268	P-U-10	1-1/2 X 2	28.32
PJ-240273-2	P-U-5	1-1/4 X 2-1/2	18.42
PJ-240312-1	P-U-5	1-1/2 X 3	30.15
PJ-240313	P-U-10	1-3/4 X 3-1/2	28.22
PJ-240316	I-U-5	1-1/2 X 2-1/2	16.96
PJ-240316-1	I-U-5	1-1/2 X 2-1/2	16.75
PJ-240370	P-U-5	1-3/4 X 3-1/2	33.26
PJ-240461	I-U-10	1-1/2 X 2-1/2	23.70

**KINGSEAL CO., LTD. THAILAND**

46/152-153 Moo 3 Sri Saman Road
Baan Mai Pakkret, Nonthaburi Thailand 11120

Tel: +662 9617534 to 6

Fax: +662 9617540

Email: intlsales@kingseal.co.th / kingsealmail@gmail.com

Website: <http://www.kingseal.co.th>

Replacement Kits For

PAK-MOR

PAK-MOR

Front Loaders							
APPLICATION	CYL #	Cylinder Type	CODE	ROD	BORE	KIT #	List \$
MODEL FHC 800, FHC 8338							
CONTAINER LEVELING	4148009AC		I-U-5	2	4	PKM-4148096	34.14
LIFT ARM PACKER	4149004AA		I-U-5	2	5	PKM-4148090	33.75
		Commercial Hyd. Cyl. w/ 3-3/4" 7.905" stages or Custom Hoist Cyl. w/ 4"-8" stages.					
REAR DOOR	4148048AD		I-U-5	1-1/2	3	PKM-4148097	26.19
TILT ARM	4148077AB		I-U-5	2	4	PKM-4148098	34.55
TOP DOOR	4148078AC		I-U-5	2	4	PKM-4148096	34.14
Rear Loaders							
APPLICATION	CYL #	Cylinder Type	CODE	ROD	BORE	KIT #	List \$
MODEL R100B							
EJECTOR	2000102	Telescopic Cylinder	I-V-12	4, 5	4-1/2, 5-1/2	PKM-2843163	241.71
	2001102	Telescopic Cylinder	I-V-12	4, 5	4-1/2, 5-1/2	PKM-2843163	241.71
	4148038AB	Piston Type Cylinder	I-U-5	2-1/2	5	PKM-4148092	47.19
	4148039AC	Piston Type Cylinder	I-U-5	4	5	PKM-4149001	52.25
	4148040AC	Piston Type Cylinder	I-U-5	4	5	PKM-4149001	52.25
	SD52DC-8-119	2 Stage Commercial Hyd. Cyl., 3-1/4" & 4-3/4" stages.					
	SD52DC-8-140	2 Stage Commercial Hyd. Cyl., 3-1/4" & 4-3/4" stages.					
PACKER	4148003		I-U-5	2-1/2	4	PKM-4148094	36.77
SWEEP	4148006AD		I-U-5	2-1/2	4	PKM-4148094	36.77
TAILGATE	4149039		I-U-4	2-1/2	3-1/2	PKM-4148093	23.93
WINCH	4148044AC		I-U-5	3	6	PKM-4148091	67.12
MODEL R200							
CONTAINER	466-01		I-OB-3	1-1/4	3-1/2	PKM-UD648-34	5.25
EJECTOR	2149-LM		I-U-5	2-1/2	5	PKM-2019-34	39.19
	2957-LM		I-U-5	2-1/2	5	PKM-2671-34	39.26
	2958-LM, 2959-LM		I-U-5	4	5	PKM-1471-34	37.42
	D52CD-77-80	Single Stage Commercial Hyd. Cyl., 4-3/4" stage.					
	D52CD-77-86 1/2	Single Stage Commercial Hyd. Cyl., 4-3/4" stage.					
	SC52DC-8-140	2 Stage Commercial Hyd. Cyl., 3-3/4" & 4-3/4" stages.					
	SD52DC-8-119	2 Stage Commercial Hyd. Cyl., 3-3/4" & 4-3/4" stages.					
PACKER	3802-LM		I-U-5	2-1/2	5	PKM-1362-34	36.82
SWEEP	3809-LM		I-U-5	2-1/2	5	PKM-1362-34	36.82
TAILGATE	792-LM		I-U-5	2-1/2	3-1/2	PKM-UD2167-34	31.68
MODEL R200B							
EJECTOR	2000102	Telescopic Cylinder	I-V-12	4, 5	4-1/2, 5-1/2	PKM-2843163	241.71
	2001102	Telescopic Cylinder	I-V-12	4, 5	4-1/2, 5-1/2	PKM-2843163	241.71
	4148038AB	Piston Type Cylinder	I-U-5	2-1/2	5	PKM-4148092	47.19
	4148039AC	Piston Type Cylinder	I-U-5	4	5	PKM-4149001	52.25
	4148040AC	Piston Type Cylinder	I-U-5	4	5	PKM-4149001	52.25
	SD52DC-8-119	2 Stage Commercial Hyd. Cyl., 3-1/4" & 4-3/4" stages.					

Replacement Kits For

PAK-MOR**PAK-MOR**

Rear Loaders							
APPLICATION	CYL #	Cylinder Type	CODE	ROD	BORE	KIT #	List \$
MODEL R200B							
EJECTOR	SD52DC-8-140	2 Stage Commercial Hyd. Cyl., 3-1/4" & 4-3/4" stages.					
PACKER	4148023		I-U-5	2-1/2	5	PKM-4148089	47.19
SWEEP	4148022		I-U-5	2-1/2	5	PKM-4148089	47.19
WINCH	4148044AC		I-U-5	3	6	PKM-4148091	67.12
MODEL R300B							
EJECTOR	2000102	Telescopic Cylinder	I-V-12	4, 5	4-1/2, 5-1/2	PKM-2843163	241.71
	2001102	Telescopic Cylinder	I-V-12	4, 5	4-1/2, 5-1/2	PKM-2843163	241.71
	4148038AB	Piston Type Cylinder	I-U-5	2-1/2	5	PKM-4148092	47.19
	4148039AC	Piston Type Cylinder	I-U-5	4	5	PKM-4149001	52.25
	4148040AC	Piston Type Cylinder	I-U-5	4	5	PKM-4149001	52.25
	SD52DC-8-119	2 Stage Commercial Hyd. Cyl., 3-1/4" & 4-3/4" stages.					
	SD52DC-8-140	2 Stage Commercial Hyd. Cyl., 3-1/4" & 4-3/4" stages.					
PACKER	4148037		I-U-5	3	6	PKM-4148091	67.12
TAILGATE	4148018AE		I-U-4	2-1/2	3-1/2	PKM-4148093	23.93
WEEP	4148000AC		I-U-5	3	6	PKM-4148091	67.12
WINCH	4148044AC		I-U-5	3	6	PKM-4148091	67.12

For applications using Commercial Hydraulics telescopic cylinders, please see the Commercial Hydraulics section of this catalog for a listing of available replacement parts.

Kit Number	Code (Pg. x)	Rod X Bore Size	List Price	Kit Number	Code (Pg. x)	Rod X Bore Size	List Price
PKM-1101-34	I-U-5	1-1/2 X 3	\$ 21.05	PKM-4148091	I-U-5	3 X 6	\$ 67.12
PKM-1128-34	I-U-5	3 X 5	42.58	PKM-4148092	I-U-5	2-1/2 X 5	47.19
PKM-1362-34	I-U-5	2-1/2 X 5	36.82	PKM-4148093	I-U-4	2-1/2 X 3-1/2	23.93
PKM-1471-34	I-U-5	4 X 5	37.42	PKM-4148094	I-U-5	2-1/2 X 4	36.77
PKM-1963-34	I-OB-3	1-1/2 X 2-1/2	8.72	PKM-4148096	I-U-5	2 X 4	34.14
PKM-2019-34	I-U-5	2-1/2 X 5	39.19	PKM-4148097	I-U-5	1-1/2 X 3	26.19
PKM-2194LM	I-U-5	5 X 6	62.53	PKM-4148098	I-U-5	2 X 4	34.55
PKM-2302-34	I-OB-3	3/4 X 1-1/2	9.70	PKM-4149001	I-U-5	4 X 5	52.25
PKM-2608-34	I-OB-4	2-1/2 X 4	12.91	PKM-4149037	I-U-5	1-1/2 X 2-1/2	19.36
PKM-2671-34	I-U-5	2-1/2 X 5	39.26	PKM-4149048	I-U-5	1-1/2 X 3-1/3	17.36
PKM-2843115	I-U-5	1-1/2 X 3	17.30	PKM-4149051	I-U-5	2 X 4	36.32
PKM-2843129	I-OB-3	3/4 X 1-1/2	8.78	PKM-4149052	I-U-5	1-1/2 X 2-1/2	15.14
PKM-2843163	Repair kit for cyl 2000102, 2001102		241.71	PKM-4149066	I-U-5	2-1/2 X 3-1/2	29.09
PKM-2843164	Vee Sets & Wipers for above		38.89	PKM-4149107	I-U-5,12	1-1/2 X 2-1/2	55.71
PKM-2843168	Vee Sets, Wipers & Bushings for above		72.41	PKM-4149116	I-U-5,12	1-1/2 X 3	57.77
PKM-3016-34	I-U-10	2-1/2 X 3-1/2	14.63	PKM-4149118	I-U-5,12	1-1/4 X 2	33.78
PKM-4148024	I-U-5	2-1/2 X 4	33.81	PKM-4149124	I-U-5,12	1-1/2 X 3-1/2	64.33
PKM-4148027	I-U-5	1-1/2 X 2-1/2	22.87	PKM-625-34	I-U-5	2 X 4	26.52
PKM-4148032	I-U-4	2-1/2 X 3-1/2	21.76	PKM-646-34	I-OB-1	1-3/4 X 2-1/2	10.29
PKM-4148034	I-U-5	2-1/2 X 5	41.82	PKM-647-34	I-U-5	2 X 3	17.96
PKM-4148035	I-U-4	2-1/2 X 4	23.27	PKM-989-34	I-OB-3	1-1/2 X 2-1/2	10.42
PKM-4148036	I-U-5	3 X 6	53.81	PKM-UD1990-34	I-U-5	2-1/2 X 4	31.22
PKM-4148089	I-U-5	2-1/2 X 5	47.19	PKM-UD2167-34	I-U-5	2-1/2 X 3-1/2	31.68
PKM-4148090	I-U-5	2 X 5	33.75	PKM-UD648-34	I-OB-3	1-1/4 X 3-1/2	5.25

REPLACEMENT KITS FOR PEABODY GALION TELESCOPIC CYLINDER PARTS & KITS

PEABODY

PACKING: Vee packing - no top adaptor. .275" c.s.
WIPERS: Urethane; wiper does not snap into a groove, but is trapped between the head nut and top bearing.
BEARINGS: Castiloid (cast iron) outer bearing, grooved to serve as top adaptor for packing. Single action cylinders have inner bearing trapped between 2 spiral retainer rings. Double action cylinders (see below).
PISTON: Single action cylinder has 2 half-moon shaped castiloid bearings that fit into a groove at piston end of stage.
STAGE O.D.'s: 1.970; through 7.970; 9.125.
SPECIAL INFO: Stage diameters all .030" under nominal inch except 9.125. All stage bores .020 over nominal half-inch.
IDENTIFICATION: Model number stamped into "steadrest" area near gland collar on body.

DOUBLE ACTION SAME AS ABOVE EXCEPT:
BEARINGS: Has no inner bearing. Instead there is a steel spacer ring "trapped" between the two spiral retainers.
PISTON: Double action cylinder has bronze piston and threads onto stage. 2 or 3 "butt-cut" piston rings per stage in separate grooves.

PEABODY GALION

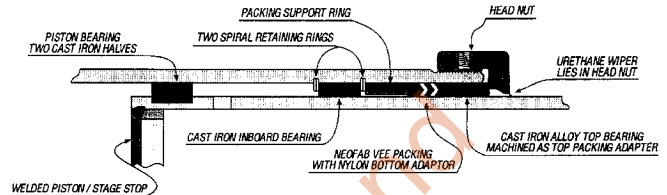

Part Number	Description	List Price
PACKINGS AND WIPERS		
PG-2VSW	1.970" Vee Set & Wiper	\$ 10.82
PG-3VSW	2.970" Vee Set & Wiper	13.63
PG-4VSW	3.970" Vee Set & Wiper	17.34
PG-5VSW	4.970" Vee Set & Wiper	22.54
PG-6VSW	5.970" Vee Set & Wiper	27.60
PG-7VSW	6.970" Vee Set & Wiper	36.32
PG-8VSW	7.970" Vee Set & Wiper	38.68
PG-9VSW	9.125" Vee Set & Wiper	47.87
PACKING & BEARING KITS		
PG-3PBK	2.970" Vee Set, Wiper & Top Bearing	\$ 25.64
PG-4PBK	3.970" Vee Set, Wiper & Top Bearing	29.46
PG-5PBK	4.970" Vee Set, Wiper & Top Bearing	37.16
PG-6PBK	5.970" Vee Set, Wiper & Top Bearing	47.20
PG-7PBK	6.970" Vee Set, Wiper & Top Bearing	56.72
PG-8PBK	7.970" Vee Set, Wiper & Top Bearing	75.04
PG-9PBK	9.125" Vee Set, Wiper & Top Bearing	109.01
RETAINER RINGS		
PG10-5304	2" SPIRAL RETAINER RING	\$ 3.50
PG10-25689	3" SPIRAL RETAINER RING	7.87
PG10-25688	4" SPIRAL RETAINER RING	7.19
PG10-25687	5" SPIRAL RETAINER RING	7.50
PG10-25686	6" SPIRAL RETAINER RING	5.82
PG10-25718	7" SPIRAL RETAINER RING	7.69
PG10-25729	8" SPIRAL RETAINER RING	15.67
PG10-26982	9-1/8" SPIRAL RETAINER RING	27.44
PISTON RINGS - DOUBLE ACTION ONLY		
PG10-25892	3-1/2" PISTON RING	\$ 8.62
PG10-25880	4-1/2" PISTON RING	8.79
PG10-28824	4.54" PISTON RING	8.95
PG10-30863	5.00" PISTON RING	9.24
PG10-25868	5-1/2" PISTON RING	12.41
PG10-28825	5.54" PISTON RING	12.36
PG10-25867	6-1/2" PISTON RING	12.72
PG10-25866	7-1/2" PISTON RING	17.18
PG10-25891	8-1/2" PISTON RING	19.29

Part Number	Description	List Price
STOP RINGS		
1 piece = 1/2 stop ring		
PG10-5224	4" Stop Ring	\$ 68.90
PG10-5225	5" Stop Ring	22.47
PG10-5226	6" Stop Ring	58.30
PG10-5299	7" Stop Ring	84.80
PG10-5298	8" Stop Ring	63.60
HEAD NUTS (MEASURED AT THREAD I.D.)		
PG10-25673	4" HEAD NUT	\$ 77.34
PG10-25672	5" HEAD NUT	93.92
PG10-25671	6" HEAD NUT	107.49
PG10-25670	7" HEAD NUT	123.23
PG10-25708	8" HEAD NUT	160.83
PG10-25709	9" HEAD NUT	177.26
MISCELLANEOUS PARTS		
PG10-25440	BLEEDER VALVE	\$ 2.48
PG10-11641	NYLON SLUG	.45
PG10-0839	PIN-EYE BUSHING	37.10
PG10-27728	SET SCREW	.90
KITS		
PG-37PBK	3" - 7" Packing, Wiper, Top Bearing, Set Screws & Slugs	\$ 196.17
PG-38PBK	3" - 8" Packing, Wiper, Top Bearing, Set Screws & Slugs	271.21
PG-35PBK	3" - 5" Vee Set, Wiper & Top Bearing	92.27
PG-46PBK	4" - 6" Packing, Wiper, Top Bearing, Set Screws & Slugs	113.82
PG-47PBK	4" - 7" Packing, Wiper, Top Bearing, Set Screws & Slugs	170.54
PG-48PBK	4" - 8" Packing, Wiper, Top Bearing, Set Screws & Slugs	245.58
PG-49PBK	4" - 9" Vee Set, Wiper & Top Bearing	365.19
PG-57PBK	5" - 7" Packing, Wiper, Top Bearing, Set Screws & Slugs	141.09
PG-58PBK	5" - 8" Packing, Wiper, Top Bearing, Set Screws & Slugs	216.12
PG-67PBK	6" - 7" Packing, Wiper, Top Bearing, Set Screws & Slugs	103.92

REPLACEMENT KITS FOR PEABODY GALION TELESCOPIC CYLINDER PARTS & KITS

Part Number	Description	List Price
KITS		
PG-68PBK	6" - 8" Packing, Wiper, Top Bearing, Set Screws & Slugs	\$ 178.96
PG-3TA	2.970" TOP ADAPTOR	1.99
PG-4TA	3.970" TOP ADAPTOR	2.54
PG-5TA	4.970" TOP ADAPTOR	2.43
PG-6TA	5.970" TOP ADAPTOR	2.88
PG-7TA	6.970" TOP ADAPTOR	4.39
PG-8TA	7.970" TOP ADAPTOR	5.52
PG-10-40938	1-1/4" VEE SET	8.36
PG-10-12546	3.997" ID WIPER	2.75
PG-35	3" - 5" Packing, Wiper, Set Screw, Slug	56.18
PG-36	3" - 6" Packing, Wiper, Set Screw, Slug	85.17
PG-37	3" - 7" Packing, Wiper, Set Screw, Slug	121.50
PG-38	3" - 8" Packing, Wiper, Set Screw, Slug	162.11
PG-45	4" - 5" Vee Set & Wiper Set Screw, Slug	41.85
PG-46	4" - 6" Packing, Wiper, Set Screw, Slug	70.85
PG-47	4" - 7" Packing, Wiper, Set Screw, Slug	107.19
PG-48	4" - 8" Packing, Wiper, Set Screw, Slug	147.79
PG-49	4" - 9" Packing, Wiper, Set Screw, Slug	198.05

Part Number	Description	List Price
KITS		
PG-56	5" - 6" Vee Set & Wiper Set Screw, Slug	\$ 55.25
PG-57	5" - 7" Packing, Wiper, Set Screw, Slug	88.98
PG-58	5" - 8" Packing, Wiper, Set Screw, Slug	129.57
PG-67	6" - 7" Packing, Wiper, Set Screw, Slug	65.30
PG-68	6" - 8" Packing, Wiper, Set Screw, Slug	105.92
PG-SR38	3" - 8" Spiral Snap Ring Kit	91.54
PG-PR38	3-1/2" - 8-1/2" Piston Ring Kit	215.52
PG-PR48	4-1/2" - 8-1/2" Piston Ring Kit	197.59
PG91-04176	6" , 7-1/8" , 8-3/8" , 9-3/4" Vee Sets, Wipers and Piston Bearings	419.95
PARTS FOR 104176-ADA		
PG91-04176	6" , 7-1/8" , 8-3/8" , 9-3/4" Vee Sets, Wipers and Piston Bearings	\$ 419.95
PG10-51431	6" Cast Iron Bushing	101.44
PG10-51445	6-1/2" OD Cast Iron Piston Ring	24.58
PG10-51430	7-1/8" Cast Iron Bushing	123.67
PG10-17892	8 X .310 X .265/.295 Piston Ring	22.21
PG10-51429	8-3/8" Cast Iron Bushing	151.74
PG10-51428	9-3/4" Cast Iron Bushing	161.75

PEABODY GALION E-Z PACK GARBAGE TRUCK KITS

Kit Number	Cylinder	Code (Pg. x)	Rod X Bore Size	List Price
PG-2.5UW	2.470" ROD	U-SEAL & WIPER		\$ 12.14
PG-2101220	K4549-LDA	P-UB-12,14..2	X 4-1/2	107.46
PG-2115K	2115	I-V-1	2" ROD	15.12
PG-2534DAK	2534DA	I-U-5	1-3/4 X 2-1/2	16.05
PG-2UW	1.970" ROD	U-SEAL & WIPER		14.59
PG-3021CDAK	3021 CDA	I-U-5	2 X 3	29.92
PG-3027DAK	3027DA, 3032DA	I-U-5	2 X 3	46.16
PG-3032DAK	3032DA	I-U-5	2 X 3	46.16
PG-3120K	3120	I-V-1	3" ROD	14.89
PG-3128DAK	3128A	I-V-1	3" ROD	14.89
PG-3514DAK	3514DA	I-U-5	2-1/2 X 3-1/2	25.75
PG-3530ADAK	3530ADA	I-U-5	1-3/4 X 3-1/2	22.38
PG-3UW	2.970" ROD	U-SEAL & WIPER		16.38
PG-4021EDAK	4021EDA	I-U-5,12	2-1/2 X 4	51.79
PG-4027CDAK	4027CDA, 4032DA, 4037CDA	I-U-5	2-1/2 X 4	31.39
PG-4030DAK	4030DA	I-U-5	2 X 4	32.96
PG-4032DAK	4032DA	I-U-4	2-1/2 X 4	24.77
PG-4033BDAPR	4033BDA	I-U-12	2-1/2 X 4	34.07
PG-4042BDAK	4042BDA	I-U-10	2-1/4 X 4	27.03
PG-4042DAKPR	4042DA	I-U-12	2-1/2 X 4	34.07
PG-4046ADAK	4046ADA	I-V-1	3 X 4	14.69
PG-4128K	4128C	I-V-1	4" ROD	19.44
PG-4521DAK	4521DA	I-V-1	2 X 4-1/2	17.98
PG-4521DAKPR	4521DA	I-V-12	2 X 4-1/2	37.63

Kit Number	Cylinder	Code (Pg. x)	Rod X Bore Size	List Price
PG-4522DAK	4522DA	I-V-1	2 X 4-1/2	\$ 15.53
PG-4522DAKPR	4522DA	I-V-12	2 X 4-1/2	35.15
PG-4522EDAK	4522EDA	I-U-1	2 X 4-1/2	16.55
PG-4522EDAPR	4522EDA	I-U-12	2 X 4-1/2	39.64
PG-4522JDAK	D4522JDA	I-U-12	2 X 4-1/2	40.78
PG-4538BDAK	4538BDA	1-V-10,12	2 X 4-1/2	30.62
PG-4543DAKPR	4543DA	I-U-12	2 X 4-1/2	55.61
PG-4546DAPR	4546DA	I-U-12	2 X 4-1/2	52.84
PG-4UW	3.970" ROD	U-SEAL & WIPER		18.69
PG-5054ADAK	5054ADA	I-U-1	3 X 5	19.46
PG-5054ADAPR	5054ADA	I-U-12	3 X 5	84.28
PG-5055ADAK	5055ADA	I-U-1	4 X 5	22.65
PG-5055ADAPR	5055ADA	I-U-12	4 X 5	58.82
PG-5532DAKPR	5532DA	"I-U-5,12"	2-3/4 X 5-1/2	58.77
PG-5553DAK	5553DA	I-V-1	3 X 5-1/2	21.53
PG-5553DAKPR	5553	I-V-12	3 X 5-1/2	52.95
PG-5554DAK	5554DA	I-V-1	3 X 5-1/2	21.53
PG-5554DAKPR	5554DA	I-V-12	3 X 5-1/2	54.08
PG-5554EDAK	5554EDA	I-U-1	3 X 5-1/2	33.24
PG-5554EDAPR	5554 EDA	I-U-12	3 X 5-1/2	82.84
PG-5UW	4.970" ROD	U-SEAL & WIPER		22.92
PG-6054DAK	6054	I-V-1	3 X 6	20.90
PG-6540ADAK	6540ADA	I-V-5	4 X 6-1/2	82.23
PG-6540DAK	6540DA	I-V-12	4 X 6-1/2	168.41
PG-6553DAK	6553DA	I-V-1	3 X 6-1/2	23.61
PG-7078DAK	7078D	I-U-5	5 X 7	72.44

PEABODY GALION

E-Z PACK GARBAGE TRUCK KITS - FOR DANA BUILD CYLINDERS

Kit Number	Cylinder	Code (Pg. x)	Rod X Bore Size	List Price
PG59-01478	D63124FDA	I-V-1	4, 5, 6, Stages	\$ 114.85
PG59-01501	D74162ADA	I-V-1	4, 5, 6, 7 Stages	166.41
PG59-01504	D5391	I-V-1	3, 4, 5 Stages	95.45
PG59-01505	D4258	I-V-1	3, 4 Stages	42.80
PG59-01507	D6292CDA	I-V-1	5, 6 Stages	69.98
PG59-02563	D2534CDA, D2563BDA	I-U-10	1-3/4 X 2-1/2	27.54
PG59-03021	D3021GDA	I-U-10	2 X 3	17.08
PG59-03128	D3128C	I-V-1	3 X 3-1/2	18.78
PG59-03516	D3516CDA	I-U-10	1-3/4 X 3-1/2	14.05
PG59-03526	D3526HDA	I-U-10	1-3/4 X 3-1/2	17.50
PG59-04028	D4028CDA,	I-U-10	2-3/4 X 4	20.38
PG59-04030	D4030EDA	I-U-10	2 X 4	17.97
PG59-04035	D4035HDA	I-U-10	2-1/2 X 4	20.65
PG59-04526	D4548 DA	I-U-12	2 X 4-1/2	42.15
PG59-04548		I-U-12	2 X 4-1/2	63.98
PG59-04549	D4549BDA	I-U-10,12	2 X 4-1/2	29.81

Kit Number	Cylinder	Code (Pg. x)	Rod X Bore Size	List Price
PG59-05532	D5532DDA	I-U-10,12	2-3/4 X 5-1/2	\$ 69.21
PG59-05554	D5554GDA	I-U-12	3 X 5-1/2	72.59
PG59-06042	D6042BDA	I-U-10,12	2-3/4 X 6	55.35
PG59-4028GDA	D4028GDA	I-V-10	2-3/4 X 4	26.55
PG59-46124		I-V-10	2 X 7	26.40
PG59-46135	D5054CDA	I-U-12	3 X 5	77.14
PG59-46139	D6067ADA	I-V-10	5 X 6	110.73
PG59-46150	D3018DDA	I-U-10	2 X 3	15.15
PG59-46156		I-U-10,12	2-3/4 X 5-1/2	68.06
PG59-46167	D1510	I-OB-1	1 X 1-1/2	5.64
PG59-46173		I-U-10	3 X 8	59.30
PG59-46818	D3549ADA	I-U-10,12	2 X 3-1/2	22.29
PG59-46819	D3016ADA	I-U-10	1-1/2 X 3	12.46
PG59-46823	D5067ADA	I-V-10	4 X 5	46.52
PG59-47048	D3033ADA	I-U-10	1-3/4 X 3	19.82
PG59-48531		I-V-10	2 X 3-1/2	25.16
PG59-49897		I-V-14	2-1/4 X 4	62.84

PEABODY GALION

E-Z PACK GARBAGE TRUCK KITS - FOR PEABODY GALION BUILD CYLINDERS

Kit Number	Cylinder	Code (Pg. x)	Rod X Bore Size	List Price
PG91-01530		P-U-4	2-1/2 X 5	\$ 27.66
PG91-01533	5381B	I-V-1	3, 4, 5 Stages	50.73
PG91-02534	2534BDA, 2563ADA	I-U-5	1-3/4 X 2-1/2	13.77
PG91-03021	3021CDA	I-U-5	2 X 3	22.53
PG91-03036		I-U-5	1-3/4 X 3-1/2	33.74
PG91-03516	3516CDA	I-U-4,10	1-3/4 X 3-1/2	33.57
PG91-03530	3526CDA, 3526EDA	I-U-5	1-3/4 X 3-1/2	18.78
PG91-04016		I-U-5	1-3/4 X 4	22.86
PG91-04028	4028DA	I-U-4	2-3-4 X 4	23.68
PG91-04035	4035CDA	I-U-5	2-1/2 X 4	26.01
PG91-04526		I-U-12	2 X 4-1/2	49.42
PG91-04546	4548DA	I-U-12	2 X 4-1/2	52.84

Kit Number	Cylinder	Code (Pg. x)	Rod X Bore Size	List Price
PG91-05054		I-U-12	3 X 5	\$ 88.50
PG91-06042	6042DA	I-U-5,12	2-3/4 X 6	60.44
PG91-06067	6067ADA	I-U-10	5 X 6	60.44
PG91-13021	3021FDA	I-U-10	2 X 3	31.75
PG91-13516	3516BDA	I-U-10	1-3/4 X 3-1/2	29.47
PG91-13526		I-U-10	1-3/4 X 3-1/2	29.47
PG91-14028	4028BDA	I-U-10	2-3/4 X 4	30.44
PG91-14030	4030DDA	I-U-10	2 X 4	34.72
PG91-14035	4035EDA, 4035FDA	I-U-10	2-1/2 X 4	40.48
PG91-14549	4549DA, 4549ADA	I-U-10,12	2 X 4-1/2	45.60
PG91-16042	6042ADA	I-U-10,12	2-3/4 X 6	58.07
PG91-25554	5554FDA	I-U-12	3 X 5-1/2	90.16

PEABODY GALION

GALION-DAYBROOK LIFT GATE KITS

Part Number	Description	List Price
PG-10-40938	MODEL T1000, G10E	\$ 8.36
PG-20-33398	MODEL T8000E, T888R-CF, G8E, G8E-CG	28.69

PEABODY GALION

GALION DUMP PUMP PARTS

Part Number	Description	List Price
PG10-147	BEARING - 1-1/2" O.D.	\$ 18.78
PG10-17635	PUMP HOUSING GASKET	.91
PG10-17636	PUMP WEAR PLATE	45.23
PG10-17662	BEARING - 1-5/16" O.D.	15.58
PG-20-23878	13/16" VEE SET ONLY	4.39
PG-91-02101	13/16" COMPLETE SHAFT END COVER KIT	26.56
PG-DP100-200	COMPLETE 13/16" SHAFT KIT, GASKETS, AND O-RING	101.28

Replacement Kits For

PEERLESS

PEERLESS - PERFECTION

Log Loaders

APPLICATION	CODE	ROD	BORE	KIT #	List \$
MODEL 2170B					
JIB BOOM	I-U-10	3	7	PRLS-842937500	41.67
MAIN BOOM	I-U-10	3	6	PRLS-842936800	51.68
STABILIZER	I-U-10	3	6	PRLS-842936800	51.68
MODEL 2770					
JIB BOOM	I-U-10	3-1/2	7	PRLS-842938200	60.29
MAIN BOOM	I-U-10	3	6	PRLS-842936800	51.68
STABILIZER	I-U-10	3	6	PRLS-842936800	51.68

PEERLESS

Kit Number	Code (Pg. x)	Rod X Bore Size	List Price
PRLS-300-4-446-4	I-U-13	3 X 6	\$ 55.89
PRLS-300-4-534-4	I-U-10	3 X 7	42.67
PRLS-300-5-510-4	I-U-10	3 X 7	41.67
PRLS-300-5-511-4	I-U-10	3 X 6	35.82

Kit Number	Code (Pg. x)	Rod X Bore Size	List Price
PRLS-842936800	I-U-10, 12	3 X 6	\$ 51.68
PRLS-842937500	I-U-10	3 X 7	41.67
PRLS-842938200	I-U-10	3-1/2 X 7	60.29

PERFECTION - COBEY TELESCOPIC CYLINDER PARTS

- PACKING:** Vee packing with top and bottom adaptors. 3, 4, & 5" stages have .265" CS. 6,7, & 8 have 1/4" CS. 9" stage has 3/8" CS.
- WIPERS:** Urethane snap-in type.
- BEARINGS:** Original were bronze. Many replacements being offered in either glass-filled nylon or mineral filled nylon material. 3" through 6" stages have bearings above and below packing. 7" and 8" stages have bearing above packing only.
- PISTON:** Bronze bearing held in place by 2 spring steel snap rings.
- STAGE O.D.'s:** 2.580", 3.580", 4.580", 5.445", 6.445", 7.445", 8.445"
- SPECIAL INFO.** Internally threaded ring which serves as internal stop.
- IDENTIFICATION:** Model number and serial number stamped near base of cylinder.

PERFECTION

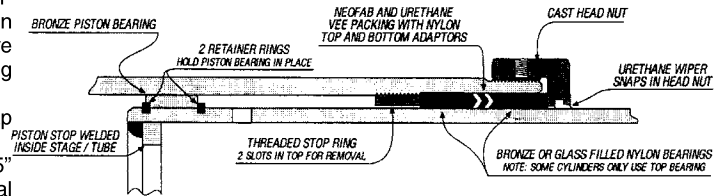

Kit Number	Stage O.D.	Description	List Price
PACKING & WIPERS			
PF-3VSW	2.580	Vee Set & Wiper	\$ 12.43
PF-4VSW	3.580	Vee Set & Wiper	24.42
PF-5VSW	4.580	Vee Set & Wiper	30.10
PF-6VSW	5.445	Vee Set & Wiper	29.52
PF-7VSW	6.445	Vee Set & Wiper	39.71
PF-8VSW	7.445	Vee Set & Wiper	44.69
PF-9VSW	8.445	Vee Set & Wiper	126.47

Kit Number	Stage O.D.	Description	List Price
BEARINGS			
PF-4NB	3.580	Gland Bearing	\$ 16.38
PF-5NB	4.580	Gland Bearing	19.95
PF-6NB	5.445	Gland Bearing	21.63
PF-7NB	6.445	Gland Bearing	23.86
PF-8NB	7.445	Gland Bearing	25.42

PERFECTION - COBEY TELESCOPIC CYLINDER PARTS

Part Number	Description	List Price
KITS		
PF-35	3" - 5" Vee Set & Wiper	\$ 68.18
PF-46	4" - 6" Vee Set & Wiper	86.74
PF-47	4" - 7" Vee Set & Wiper	128.41
PF-48	4" - 8" Vee Set & Wiper	175.36
PF-49	4" - 9" Vee Set & Wiper	308.15
PF-57	5" - 7" Vee Set & Wiper	102.78

Part Number	Description	List Price
KITS		
PF-58	5" - 8" Vee Set & Wiper	\$ 149.73
PF-59	5" - 9" Vee Set & Wiper	269.08
PF-68	6" - 8" Vee Set & Wiper	119.61
PF-49U	4" - 9" U-Seal & Wiper	232.32
MISCELLANEOUS PARTS		
PF-19120	Bleeder Valve	\$ 2.48

NOTE:

HEAD NUTS, END BEARINGS AND SNAP RINGS
ARE AVAILABLE. CALL FOR PRICE.

PERFECTION - COBEY SEAL KITS FOR TWIN TELESCOPICS

Kit Number	Cyl. Number	Stage Sizes	Description	List Price
PF-50493	475	3.220, 3.830	O-Rings, Back-Ups, Wipers	\$ 18.01
PF-50494	375	2.580, 3.220	O-Rings, Back-Ups, Wipers	13.15
PF-50530	495, 498	2.580, 3.220, 3.830	O-Rings, Back-Ups, Wipers	22.05
PF-88799	375	2.580, 3.220	U-Seals, O-Rings, Wipers	23.54
PF-88800	475	3.220, 3.830	U-Seals, O-Rings, Wipers	28.49
PF-88801	495, 498	2.580, 3.220, 3.830	U-Seals, O-Rings, Wipers	37.65

NOTE:

THE ABOVE CYLINDER ASSEMBLIES ARE AVAILABLE
FROM STOCK. CALL FOR PRICES.

PERFECTION - COBEY DUMP TRUCK PUMP PARTS

Part Number	Description	List Price
PF-75175	7/8" ID Vee Set	\$ 5.20
PF-75175 Kit	7/8" Vee Sets, O-Rings, Valve Gaskets	25.57
PF-78317+BU	7/8" Shaft Seal & Back Up	7.26
PF-81566.	3/4" ID Vee Set	8.07
PF-81566 Kit	3/4" Vee Sets, O-Rings, Valve Gaskets	17.21
PF-86081	3/4" ID Oil Seal	5.54
PF-86082	7/8" ID Oil Seal	3.28
PF-86082 Kit	7/8" Shaft Pump Kit	12.25

NOTE:

COMPLETE UNITS AND PARTS (GEARS, HOUSINGS AND
BEARINGS) IN STOCK. CALL FOR PRICES.

PERFECTION - COBEY MISCELLANEOUS PERFECTION KITS & PARTS

Part Number	Description	List Price
PF-17658	#780 Valve Gasket	\$.95
PF-18273	2-3/4" Rod Vee Set	10.44
PF-18274	2" Rod Vee Set	4.89
PF-22001	2.54" Rod Dia.	2.13
PF-22002	3.22" Rod Dia.	2.39
PF-22003	3.83" Rod Dia.	2.61
PF-45007	1-1/4" ID Vee Set	4.58
PF-45030	2" ID Vee Set	6.72
PF-55152	2-1/2" ID Vee Set	8.88

Part Number	Description	List Price
PF-62463	2" ID Vee Set	\$ 6.72
PF-75175	7/8" I.D. Vee Set (each)	5.20
PF-81566	3/4" ID Vee Set	8.07
PF-84598K	P-U-52-1/2 X 4-1/2	44.65
PF-86081	3/4" I.D. Oil Seal	5.54
PF-86082	7/8" ID Oil Seal	3.28
PUMP GASKET KIT: Kit Includes 8 gaskets, 2 each of .003", .004", .005", and .007"		
PF-80937-Kit		\$ 25.44

Replacement Kits For

PETTIBONE

PETTIBONE

Rough Terrain Forklifts						
APPLICATION	CYL #	CODE	ROD	BORE	KIT #	List \$
MODEL 636						
BOOM EXT.	AL-11621-10	P-U-5	2-1/4	4	PB-LL-6014-17	81.20
FORK/TILT	AL-10774	I-U-10	3	6	PB-LL-6018-16	46.39
LIFT	AL-10775	I-U-10	4	5	PB-LL-6016-31	65.24
REAR STAB.	AL-11263-1	I-U-10	2	3-1/2	PB-LL-6013-5	60.84
SIDE TILT/FORK 48"	AL-10089	P-V-10	1-1/4	2-1/4	PB-LL-6010-2	22.84
STEERING LH	LL-2989-315	P-U-10	1-1/8	2-1/4	PB-LL-2989-325	41.04
STEERING RH	LL-2989-316	P-U-10	1-1/8	2-1/4	PB-LL-2989-325	41.04
SWAY	AL11263	I-U-10	2	3-1/2	PB-LL-6013-5	60.84
MODEL B-66						
BOOM EXT.	AL-8935	P-U-5	2-1/4	4	PB-LL-4647-15	83.05
FORK	BL-9198	P-V-10, 12	2-1/2	6	PB-LL-4647-11	78.83
SWAY L	LL-218-2035	P-V-5	1-1/4	2-1/2	PB-LL-218-2037	27.87
SWAY R	LL-218-2036	P-V-5	1-1/4	2-1/2	PB-LL-218-2037	27.87
MODEL B-66B						
BOOM EXT.	AL-8935-H	P-U-5	2-1/4	4	PB-LL-4647-15	83.05
FORK/LIFT	AL-11091	P-U-10	2-1/2	6	PB-LL-6018-18	78.36
LIFT	AL-10156	P-V-10	4-1/4	5	PB-LL-218-2320	69.21
SWAY L	AL-10355	P-V-10	1-1/4	3	PB-LL-6012-2	18.83
SWAY R	AL-10356	P-V-10	1-1/4	3	PB-LL-6012-2	18.83
MODEL B-66C						
BOOM EXT.	AL-11621-8	P-U-5	2-1/4	4	PB-LL-6014-17	81.20
FORK/TILT	AL-11091	P-U-10	2-1/2	6	PB-LL-6018-18	78.36
LIFT	AL-10157-2	P-V-10	4-1/4	5	PB-LL-218-2320	69.21
SIDE TILT/FORK 48"	AL10089	P-V-10	1-1/4	2-1/4	PB-LL-6010-2	22.84
SIDE TILT/FORK 72"	AL-10397	P-V-10	1-1/4	2-1/4	PB-LL-6010-2	22.84
STEERING	LL-2989-	I-U-10	1-1/8	2-1/4	PB-LL-2989-104	21.48
SWAY	AL-11263	I-U-10	2	3-1/2	PB-LL-6013-5	60.84
MODEL C8042						
BOOM EXT.	SK-00052	I-U-10	3	5	PB-LL-6016-3	48.62
FORK/TILT	AL-10388	I-U-10	3	7	PB-LL-6019-2	51.40
LIFT	AL-10386	I-U-10	4	5	PB-LL-6016-31	65.24
STEERING LH (FRONT)	AL-10319	P-V-10	1-1/4	2-1/2	PB-LL-6011-2	19.49
STEERING RH (FRONT)	AL-10321	P-V-10	1-1/4	2-1/2	PB-LL-6011-2	19.49
SWAY	BL-9813	I-U-10	3	5	PB-LL-6016-28	35.39



PETTIBONE

Kit Number	Code (Pg. x)	Rod X Bore Size	List Price
PB-KM-3-62	I-U-5	1-1/4 X 3	\$ 25.59
PB-KM-3-63	I-V-11	1 X 2	18.76
PB-KM-3-64	I-U-1	3, 4, 5-1/2 Tele.	89.67
PB-KM-3-66	P-OB-3	1 X 2	9.15
PB-KMP-3404	3-3/8, 4-1/2, 5-1/4 UID		104.26
PB-L7595	P-V-5	3-1/2 X 6	112.13
PB-LA6414-1	I-U-4	3 X 4-1/2	41.13
PB-LL-218-1202	P-V-4	2-1/2 X 5	46.25
PB-LL-218-170	Wiper		3.53
PB-LL-218-179	P-V-7	2 X 3-1/2	45.58
PB-LL-218-190	P-V-7	1-1/4 X 3	36.81
PB-LL-218-195	P-V-7	1-3/8 X 3-1/2	39.21
PB-LL-218-2037	P-V-5	1-1/2 X 2	27.87
PB-LL-218-2090	1-1/4 X 2-1/2	P-V-10	30.08
PB-LL-218-2320	P-V-10	4-1/4 X 5	69.21
PB-LL-218-592	P-V-10,12	1 X 2	62.56
PB-LL-2580-4	Piston Ring		13.25
PB-LL-2989-104	I-U-10	1-1/8 X 2-1/4	21.49
PB-LL-2989-325	P-U-10	1-1/8 X 2-1/4	41.03
PB-LL-4647-11	P-V-10, 12	2-1/2 X 6	78.83
PB-LL-4647-15	P-U-5	2-1/4 X 4	83.05
PB-LL-6010-2	P-V-10	1-1/4 X 2-1/4	22.84
PB-LL-6011-2	P-V-10	1-1/4 X 2-1/2	19.49
PB-LL-6012-2	P-V-10	1-1/4 X 3	18.84
PB-LL-6012-6	P-V-10	1-1/4 X 3	16.28
PB-LL-6013-5	I-U-10	2 X 3-1/2	60.83
PB-LL-6014-10	I-V-7	2-1/4 X 4	44.87
PB-LL-6014-15	P-U-10	1-1/2 X 4	34.44
PB-LL-6014-17	P-U-5	2-1/4 X 4	81.21
PB-LL-6016-28	I-U-10	3 X 5	35.39
PB-LL-6016-3	I-U-10	3 X 5	48.61
PB-LL-6016-31	I-U-10	4 X 5	65.24
PB-LL-6018-13	P-U-10	3-1/2 X 6	74.55
PB-LL-6018-16	I-U-10	3 X 6	46.39
PB-LL-6018-18	P-U-10	2-1/2 X 6	78.36
PB-LL-6019-2	I-U-10	3 X 7	51.40
PB-LL-731-3	Vee Set		16.53

P & H CRANES

Kit Number	Code (Pg. x)	Rod X Bore Size	List Price
PH-1045Z1795	I-U-10,12	5 X 6	\$ 104.75
PH-1045Z1925	P, I-OB-5	1-1/2 X 3-1/2	24.99
PH-1100P351F7	I-U-10	1-1/2 X 2-1/2	11.67
PH-1100P354F3	I-U-10	2 X 4	12.61
PH-1100P357F2	I-U-10	2 X 4-1/2	23.15
PH-1100P359F1	I-U-10	4 X 4-3/4	54.00
PH-1100P361F1	I-U-10,12	4-1/4 X 5	48.71
PH-1100P362F2	I-U-10, 12	4-1/4 X 5-1/4	54.04
PH-1100P366-2	I-U-4	4 X 6	64.78
PH-1100P366F1	I-U-10	4 X 6	35.06
PH-1100P369-1	I-U-10	4-1/4 X 6-1/2	103.06
PH-1100P370-1	I-U-1-	4-3/4 X 6-1/2	130.75
PH-1100P372F1	I-U-10, 12	4-1/4 X 7	75.29
PH-1100P380F1	I-U-10, 12	4-1/4 X 9	208.58
PH-1100P381F1	I-U-10, 12	6-1/2 X 9	170.83
PH-1100P386F6	I-U-10, 12	7 X 10-1/2	323.55
PH-1100P419F2		7-3/4" Swivel	194.62



Replacement Kits For

PRENTICE

PRENTICE

Grapples & Attachments							
APPLICATION	CYL #	CODE	ROD	BORE	KIT #	Misc - Serial #, date, etc.	List \$
MODEL ALL MODELS							
CLAM BKT CYL - 1041-5/8 YD	110137	P-V-5	2-1/2	4	PR-147830		37.68
	110137	P-U-5	1-3/4	4	PR-147752		31.21
	110379	I-U-11	2-1/2	4	PR-147771		48.69
FORK CYL - 1053	110342	I-U-11	2-1/2	4	PR-147771		48.69
GRAPPLE	110353	I-U-11	2-1/2	4	PR-10032267	STYLE IV	33.27
	110354	I-U-11	2-1/2	4	PR-10032267	STYLE IV	33.27
	110355	I-U-11	2-1/2	5	PR-10032269	STYLE IV	58.12
	110376	I-U-11	2	3-1/2	PR-10032265	STYLE IV	34.39
	110380	I-U-11	2-1/2	4	PR-10032267	STYLE IV	33.27
	110386	I-U-11	2-1/2	5	PR-10032269	STYLE IV	58.12
	110415	I-U-11	2	3-1/2	PR-10032265	STYLE IV	34.39
	110428	I-U-11	2	3-1/2	PR-10032265	STYLE IV	34.39
	110435	I-U-11	2	3-1/2	PR-10032265	STYLE IV	34.39
	110501	I-U-11	2-1/2	4	PR-10032267	STYLE IV	33.27
GRAPPLE - 1/2 CORD 270/CR, 848 WEDGE 270/CR	110302	I-U-5	2-1/2	4	PR-147751		31.64
	110354	I-U-11	2-1/2	4	PR-147771		48.69
GRAPPLE - 1/2 CORD SLASHER C/R	110321	I-U-11	2-1/2	4	PR-147766		25.26
	110353	I-U-11	2-1/2	4	PR-147771		48.69
GRAPPLE - 3/4 & 1 CORD 270/CR	110386	I-U-11	2-1/2	5	PR-147780		41.81
GRAPPLE - 3/4 & 1 CORD 270/CR & 955, 1060, 1066, & 1372 WEDGE 270/CR	110303	I-U-5	2-1/2	5	PR-147746		51.00
GRAPPLE - 310/410,342,351,CBP	110266	I-U-5	1-1/2	3-1/2	PR-147753		25.10
GRAPPLE - 315	110376	I-U-11	2	3-1/2	PR-147770		43.07
GRAPPLE - 442, AC442, TC442, & CX442	110415	I-U-11	2	3-1/2	PR-147770		43.07
GRAPPLE - 734	110428	I-U-11	2	3-1/2	PR-147770		43.07
GRAPPLE - 742 WEDGE 270/CR	110267	P-U-5	1-3/4	3-1/2	PR-147754		24.36
	110358	I-U-11	2	3-1/2	PR-10032265	STYLE IV	34.39
	110358	I-U-11	2	3-1/2	PR-147770		43.07
GRAPPLE - 955, 1060, 1066, & 1372 WEDGE 270/CR	110355	I-U-11	2-1/2	5	PR-147780		41.81
GRAPPLE - C554	110501	I-U-11	2-1/2	4	PR-147771		48.69
GRAPPLE - C656S, CX656S, C762S, CX762S	110435	I-U-11	2	3-1/2	PR-147770		43.07
GRAPPLE - C752S	110380	I-U-11	2-1/2	4	PR-147771		48.69
SLASHER - 752	110380	I-U-11	2-1/2	4	PR-147771		48.69
Knuckle Boom Loaders							
APPLICATION	CYL #	CODE	ROD	BORE	KIT #	Misc - Serial #, date, etc.	List \$
MODEL 410C, SERIES F							
GRAPPLE	110087	P-V-1	1-1/2		PR-147515	S/N All	19.73
	110087	P-V-5	1-1/2	3-1/2	PR-147819	S/N All	29.30
	110134	P-V-1	1-3/4		PR-147509	S/N All	14.61
	110134	P-V-5	1-3/4	4	PR-147812	S/N All	29.84
SWING ASSY	110035	I-V-7	4	6	PR-147605	S/N Prior - 8199	51.19
	110036	N-N-5		4	PR-147816	S/N 8200 - 10067	26.81
	110060	N-N-9		4	PR-147628	S/N 10068 -->	47.17

Replacement Kits For

PRENTICE

PRENTICE

Knuckle Boom Loaders							
APPLICATION	CYL #	CODE	ROD	BORE	KIT #	Misc - Serial #, date, etc.	List \$
MODEL 410C, SERIES G							
GRAPPLE	110087	P-V-1	1-1/2		PR-147515	S/N All	19.73
	110087	P-V-5	1-1/2	3-1/2	PR-147819	S/N All	29.30
	110134	P-V-1	1-3/4		PR-147509	S/N All	14.61
	110134	P-V-5	1-3/4	4	PR-147812	S/N All	29.84
H.D. STABILIZER	110042	P-V-1	2	-	PR-147508	S/N All	14.78
	110042	P-V-5	2	5	PR-147811	S/N All	47.95
MAIN BOOM	110036	I-V-1	4	-	PR-147505	S/N All	15.51
	110036	I-V-5	4	6	PR-147800	S/N All	50.72
STICK BOOM	110214	P-V-1	2	-	PR-147508	S/N All	14.78
	110214	P-V-5	2	5	PR-147811	S/N All	47.95
SWING ASSY	110035	I-V-7	4	6	PR-147605	S/N Prior - 8199	51.19
	110036	N-N-5		4	PR-147816	S/N 8200 - 10067	26.81
	110060	N-N-9		4	PR-147628	S/N 10068 -->	47.17
MODEL 410C, SERIES H							
GRAPPLE	110087	P-V-1	1-1/2		PR-147515	S/N All	19.73
	110087	P-V-5	1-1/2	3-1/2	PR-147819	S/N All	29.30
	110134	P-V-5	1-3/4	4	PR-147812	S/N All	29.84
	110134	P-V-1	1-3/4		PR-147509	S/N All	14.61
H.D. STABILIZER	110042	P-V-5	2	5	PR-147811	S/N All	47.95
	110042	P-V-1	2	-	PR-147508	S/N All	14.78
MAIN BOOM	110037	I-V-1	4		PR-147506	S/N All	18.37
	110037	I-V-5	4	7	PR-147802	S/N All	68.72
STICK BOOM	110216	P-V-1	2-1/2	6	PR-147514	S/N All	17.15
	110216	P-V-5	2-1/2	6	PR-147801	S/N All	53.49
SWING ASSY	111047	N-N-9		5	PR-147616	Cyls prior to 6/65	65.77
	111079	I-N-5		5	PR-147817	S/N 8200-HP7007, 11001 : 11/68 - 7/70	55.65
	111080	I-N-5		5	PR-147817	S/N 8200-HP7007, 11001 : 11/68 - 7/70	55.65
	111081	I-N-5		5	PR-147817	S/N 8200-HP7007, 11001 : 11/68 - 7/70	55.65
	204511	N-N-9		5	PR-147629	S/N 11002 -->	60.42
204512	N-N-9		5	PR-147629	S/N 11002 -->	60.42	
Loaders							
APPLICATION	CYL #	CODE	ROD	BORE	KIT #	Misc - Serial #, date, etc.	List \$
MODEL 110 BC & SR							
FORK	110083	P-V-5	1-3/4	4	PR-147842		37.68
GRAPPLE	110087	P-V-5	1-1/2	3-1/2	PR-147819		29.30
	110266	I-U-5	1-1/2	3-1/2	PR-147753		25.10
MAIN BOOM	110260	I-V-5	4	6	PR-147858	STYLE III	54.81
	110274	I-V-5	4	6	PR-147858	STYLE III	54.81
	110295	I-V-5	4	6	PR-147858	STYLE III	54.81
	110312	I-U-5	4	6	PR-147734	STYLE III	58.09
STABILIZER	110102	P-V-5	2-1/2	4	PR-147830		37.68
	110262	I-U-5	2-1/2	4	PR-147751	STYLE III	31.64
	110294	P-V-5	2-1/2	4	PR-147857	STYLE II	40.25
STICK BOOM	110253	P-U-5	2	5	PR-147747	STYLE III	49.19
	110255	P-U-5	2	5	PR-147849		61.78

Replacement Kits For

PRENTICE

Loaders							
APPLICATION	CYL #	CODE	ROD	BORE	KIT #	Misc - Serial #, date, etc.	List \$
MODEL 110 BC & SR							
TELE STABILIZER	110297	I-U-5	2-1/2	4	PR-147751	STYLE III	31.64
MODEL 120							
GRAPPLE - 442	110415	I-U-11	2	3-1/2	PR-147770		43.07
GRAPPLE - 656	110435	I-U-11	2	3-1/2	PR-147770		43.07
MAIN BOOM	110407	I-U-11	2-1/2	5	PR-147780		41.81
	110407	I-U-11	2-1/2	5	PR-10032269	STYLE IV	58.12
STABILIZER	110448	I-U-11	2	3-1/2	PR-147770		43.07
	110448	I-U-11	2	3-1/2	PR-10032265	STYLE IV	34.39
STICK BOOM	110367	I-U-11	2-1/2	5	PR-147780		41.81
	110367	I-U-11	2-1/2	5	PR-10032269	STYLE IV	58.12
TELE STICK	110357	I-U-11	2	3-1/2	PR-147770		43.07
	110357	I-U-11	2	3-1/2	PR-10032265	STYLE IV	34.39
MODEL 150							
GRAPPLE	110360	I-U-11	1-1/2	3-1/2	PR-147788		34.04
	110376	I-U-11	2	3-1/2	PR-147770		43.07
MAIN BOOM	110359	I-U-11	4	6	PR-10032275	STYLE IV	69.35
	110359	1-U-11	4	6	PR-147781		53.00
STABILIZER	110375	I-U-11	2-1/2	5	PR-10032269	STYLE IV	58.12
	110375	I-U-11	2-1/2	5	PR-147780		41.81
STICK BOOM	110359	I-U-11	4	6	PR-10032275	STYLE IV	69.35
	110359	1-U-11	4	6	PR-147781		53.00
MODEL 180							
MAIN BOOM	110344	I-U-11	4	7	PR-147769		76.61
	110344	I-U-11	4	7	PR-10032276	STYLE IV	80.68
STABILIZER	110375	I-U-11	2-1/2	5	PR-147780		41.81
	110375	I-U-11	2-1/2	5	PR-10032269	STYLE IV	58.12
STICK BOOM	110322	I-U-11	3	6	PR-147786		63.55
	110322	I-U-11	3	6	PR-10032274	STYLE IV	63.95
MODEL 180B							
GRAPPLE	110415	I-U-11	2	3-1/2	PR-147770		43.07
MAIN BOOM	110344	I-U-11	4	7	PR-147769		76.61
STABILIZER	110375	I-U-11	2-1/2	5	PR-147780		41.81
STICK BOOM	110322	I-U-11	3	6	PR-147786		63.55
MODEL 210							
MAIN BOOM	110272	I-U-5	4	6	PR-147734	STYLE III	58.09
STABILIZER	110252	I-U-5	2-1/2	5	PR-147746	STYLE III	51.00
	110273	P-V-5	2-1/2	5	PR-147731	STYLE III	41.11
STICK BOOM	110251	I-U-5	4	6	PR-147734	STYLE III	58.09
TELE STICK BOOM	110304	P-U-5	1-3/4	3-1/2	PR-147754	STYLE III	24.36
	110311	P-U-5	1-3/4	3-1/2	PR-147754	STYLE III	24.36
MODEL 210B							
MAIN BOOM	110351	1-U-11	4	6	PR-147781		53.00
STABILIZER	110350	I-U-11	3	6	PR-147786		63.55
STICK BOOM	110351	1-U-11	4	6	PR-147781		53.00
MODEL 210C							
HEEL	110524	I-U-11	4	6	PR-147111		53.00
MAIN BOOM	110464	1-U-11	4	6	PR-147781		53.00

Replacement Kits For

PRENTICE

PRENTICE

Loaders							
APPLICATION	CYL #	CODE	ROD	BORE	KIT #	Misc - Serial #, date, etc.	List \$
MODEL 210C							
STABILIZER	110350	I-U-11	3	6	PR-147786		63.55
STICK BOOM	110489	1-U-11	4	6	PR-147781		53.00
MODEL 210D							
JIB BOOM	110524	I-U-11	4	6	PR-147111		53.00
MAIN BOOM	110524	I-U-11	4	6	PR-147111		53.00
STABILIZER	110551	I-U-11	3	6	PR-147786		63.55
STICK BOOM	110524	I-U-11	4	6	PR-147111		53.00
MODEL 410							
BYPASS GRAPPLE	110267	P-U-5	1-3/4	3-1/2	PR-147754		24.36
	110276	P-V-5	1-3/4	3-1/2	PR-147736		29.51
GRAPPLE	110239	P-V-5	2	5	PR-147735	STYLE III	51.84
	110261	P-U-5	2	5	PR-147747	STYLE III	49.19
	110285	P-V-5	2	5	PR-147735		51.84
	110302	I-U-5	2-1/2	4	PR-147751		31.64
	110303	I-U-5	2-1/2	5	PR-147746		51.00
	110310	I-U-5	2-1/2	5	PR-147746		51.00
	110313	I-U-11	2-1/2	5	PR-147763		65.84
	110321	I-U-11	2-1/2	4	PR-147766		25.26
JIB BOOM	110251	I-U-5	4	6	PR-147734		58.09
	110272	I-U-5	4	6	PR-147734		58.09
MAIN BOOM	110258	I-U-5	4	6	PR-147734	STYLE III	58.09
	110291	I-U-5	4	6	PR-147734	STYLE III	58.09
STABILIZER	110257	I-U-5	4	6	PR-147734	STYLE III	58.09
	110290	I-V-5	4	6	PR-147732	STYLE III	61.19
STICK BOOM	110241	I-U-5	4	7	PR-147748		74.78
	110271	I-U-5	4	7	PR-147729	STYLE III	74.04
	110304	P-U-5	1-3/4	3-1/2	PR-147754		24.36
	110314	I-U-11	4	7	PR-147765		88.03
	110329	I-U-11	4	7	PR-147782		88.03
TELE STICK BOOM	110179	P-V-5	1-3/4	3-1/2	PR-147736	STYLE III	29.51
	110304	P-U-5	1-3/4	3-1/2	PR-147754	STYLE III	24.36
MODEL 410B							
BRAKE ACTIVATING	110345	I-U-11	2-1/2	5	PR-10032269	STYLE IV	58.12
JIB BOOM	110326	I-U-11	4	6	PR-10032275	STYLE IV	69.35
MAIN BOOM	110348	I-U-11	4	6	PR-10032275	STYLE IV	69.35
STABILIZER	110349	I-U-11	4	6	PR-10032275	STYLE IV	69.35
STEERING	110340	I-U-11	2	3-1/2	PR-10032265	STYLE IV	34.39
STICK BOOM	110323	I-U-11	4	7	PR-10032276	STYLE IV	80.68
TELE BOOM	110366	I-U-11	2	3-1/2	PR-10032265	STYLE IV	34.39
MODEL 410C							
JIB BOOM	110525	I-U-11	4	6	PR-10032275	STYLE IV	69.35
MAIN BOOM	110510	I-U-11	4	6	PR-10032275	STYLE IV	69.35
STABILIZER	110517	I-U-11	4	6	PR-10032275	STYLE IV	69.35
STICK BOOM	110513	I-U-11	4	7	PR-10032276	STYLE IV	80.68
TELE BOOM	110366	I-U-11	2	3-1/2	PR-10032265	STYLE IV	34.39
MODEL 410D							
CAB TILT	513714	P-N-2	1	2	PR-147618	S/N 27337 --> : STYLE I	6.94

Replacement Kits For

PRENTICE

PRENTICE

Loaders							
APPLICATION	CYL #	CODE	ROD	BORE	KIT #	Misc - Serial #, date, etc.	List \$
MODEL 410D							
JIB BOOM	110524	I-U-11	4	6	PR-147111	S/N 27337 -->	53.00
MAIN BOOM	110521	I-U-11	4	6	PR-10032275	S/N 27337 --> : STYLE IV	69.35
	110521	I-U-11	4	6	PR-147111	S/N 27337 -->	53.00
STABILIZER	110552	I-U-11	4	6	PR-10032275	S/N 27337 --> : STYLE IV	69.35
	110552	I-U-11	4	6	PR-147111	S/N 27337 -->	53.00
STEERING	110340	I-U-11	2	3-1/2	PR-147770	S/N 27337 -->	43.07
	110340	I-U-11	2	3-1/2	PR-10032265	S/N 27337 --> : STYLE IV	34.39
STICK BOOM	110513	I-U-11	4	7	PR-147794	S/N 27337 -->	76.61
TELE BOOM	110366	I-U-11	2	3-1/2	PR-147770	S/N 27337 -->	43.07
	110366	I-U-11	2	3-1/2	PR-10032265	S/N 27337 --> : STYLE IV	34.39
MODEL 410-DX							
CAB TILT	513714	P-N-2	1	2	PR-147618		6.94
STABILIZER	110552	I-U-11	4	6	PR-147111		53.00
STEERING	110340	I-U-11	4	6	PR-147111		53.00
STICK BOOM	10001524	I-U-11	4	6	PR-147111		53.00
MODEL 610							
GRAPPLE	110239	P-V-5	2	5	PR-147735		51.84
	110261	P-U-5	2	5	PR-147747		49.19
	110267	P-U-5	1-3/4	3-1/2	PR-147754		24.36
	110276	P-V-5	1-3/4	3-1/2	PR-147736		29.51
	110285	P-V-5	2	5	PR-147735		51.84
	110303	I-U-5	2-1/2	5	PR-147746		51.00
JIB BOOM	110259	I-U-5	4	6	PR-147734	STYLE III	58.09
	110372	I-U-11	4	6	PR-10032275	STYLE IV	69.35
	110372	I-U-11	4	6	PR-147781		53.00
MAIN BOOM	110254	I-U-5	4	7	PR-147748		74.78
	110316	I-U-11	4	7	PR-147765		88.03
	110331	I-U-11	4	7	PR-10032276	STYLE IV	80.68
	110331	I-U-11	4	7	PR-147769		76.61
	110370	I-U-11	4	7	PR-147769		76.61
	110370	I-U-11	4	7	PR-10032276	STYLE IV	80.68
STABILIZER	110242	I-U-5	4	7	PR-147748		74.78
	110369	I-U-11	4	7	PR-10032276	STYLE IV	80.68
	110369	I-U-11	4	7	PR-147769		76.61
STEERING	110250	P-V-5	1-3/4	4	PR-147740	STYLE III	37.68
	110265	P-U-5	1-3/4	4	PR-147752	STYLE III	31.21
	110365	I-U-11	2-1/2	4	PR-10032267	STYLE IV	33.27
	110365	I-U-11	2-1/2	4	PR-147771		48.69
STICK BOOM	110258	I-U-5	4	6	PR-147734		58.09
	110348	I-U-11	4	6	PR-147781		53.00
MODEL RT-610							
GRAPPLE	110239	P-V-5	2	5	PR-147735		51.84
	110261	P-U-5	2	5	PR-147747		49.19
	110267	P-U-5	1-3/4	3-1/2	PR-147754		24.36
	110276	P-V-5	1-3/4	3-1/2	PR-147736		29.51
	110285	P-V-5	2	5	PR-147735		51.84
	110303	I-U-5	2-1/2	5	PR-147746		51.00

Replacement Kits For

PRENTICE

PRENTICE

Loaders							
APPLICATION	CYL #	CODE	ROD	BORE	KIT #	Misc - Serial #, date, etc.	List \$
MODEL RT-610							
JIB BOOM	110259	I-U-5	4	6	PR-147734		58.09
	110372	1-U-11	4	6	PR-147781		53.00
MAIN BOOM	110254	I-U-5	4	7	PR-147748		74.78
	110316	I-U-11	4	7	PR-147765		88.03
	110331	I-U-11	4	7	PR-147769		76.61
STABILIZER	110370	I-U-11	4	7	PR-147769		76.61
	110242	I-U-5	4	7	PR-147748		74.78
STEERING	110369	I-U-11	4	7	PR-147769		76.61
	110250	P-V-5	1-3/4	4	PR-147740		37.68
STICK BOOM	110265	P-U-5	1-3/4	4	PR-147752		31.21
	110365	I-U-11	2-1/2	4	PR-147771		48.69
STICK BOOM	110258	I-U-5	4	6	PR-147734		58.09
	110348	1-U-11	4	6	PR-147781		53.00
Loaders & Cranes							
APPLICATION	CYL #	CODE	ROD	BORE	KIT #	Misc - Serial #, date, etc.	List \$
MODEL SERIES-3B3							
HOIST	110045	I-V-7	4	5	PR-147604	S/N Prior - 363	69.78
	110045	I-V-5	4	5	PR-147809	S/N 364 -->	53.53
	110045	I-V-1	4	-	PR-147504	S/N All	16.32
MODEL SERIES-4B4							
STABILIZER-TYPE 1 (Bolt On Head)	110102	P-V-5	2-1/2	4	PR-147830	Cyls after 11/68	37.68
	110102	P-V-7	1-3/4	4	PR-147627	Cyls prior to 11/68	36.80
STICK BOOM	110214	P-V-1	2	-	PR-147508	S/N All	14.78
	110214	P-V-7	2	5	PR-147608	S/N Prior - 363	42.39
	110214	P-V-5	2	5	PR-147811	S/N 364 -->	47.95
MODEL SERIES-4BL							
HOIST	110044	I-V-1	4	-	PR-147504	S/N All	16.32
	110044	I-V-5	4	5	PR-147809	S/N 364 -->	53.53
	110044	I-V-7	4	5	PR-147604	S/N Prior - 363	69.78
MODEL SERIES-4L4							
HOIST	110044	I-V-5	4	5	PR-147809	S/N 364 -->	53.53
	110044	I-V-7	4	5	PR-147604	S/N Prior - 363	69.78
	110044	I-V-1	4	-	PR-147504	S/N All	16.32
STABILIZER-TYPE 1 (Bolt On Head)	110102	P-V-7	1-3/4	4	PR-147627	Cyls prior to 11/68	36.80
	110102	P-V-5	2-1/2	4	PR-147830	Cyls after 11/68	37.68
MODEL SERIES-G							
MAIN BOOM	110036	I-V-7	4	6	PR-147605	S/N Prior - 363	51.19
	110036	I-V-5	4	6	PR-147800	S/N 364 -->	50.72
	110036	I-V-1	4	-	PR-147505	S/N All	15.51
STICK BOOM	110212	P-V-1	2-1/2	-	PR-147513	S/N All	14.49
	110212	P-V-5	2-1/2	5	PR-147803	S/N 364 -->	52.00
	110212	P-V-7	2-1/2	5	PR-147613	S/N Prior - 363	41.80
MODEL SERIES-GBL							
KNUCKLE (Bolt On Head)	110102	P-V-7	1-3/4	4	PR-147627	Cyls prior to 11/68	36.80
	110102	P-V-5	2-1/2	4	PR-147830	Cyls after 11/68	37.68
KNUCKLE (Snap Ring Head)	110012	P-O-7	1-3/4	4	PR-147602	Cyls prior to 11/68	26.88
	110012	P-O-5	1-3/4	4	PR-147807	Cyls after 11/68	26.62

Replacement Kits For

PRENTICE

PRENTICE

Loaders & Cranes							
APPLICATION	CYL #	CODE	ROD	BORE	KIT #	Misc - Serial #, date, etc.	List \$
MODEL SERIES-GBL							
MAIN BOOM	110036	I-V-1	4	-	PR-147505	S/N All	15.51
	110036	I-V-7	4	6	PR-147605	S/N Prior - 363	51.19
	110036	I-V-5	4	6	PR-147800	S/N 364 -->	50.72
STABILIZER-TYPE 1 (Snap Ring Head)	110013	P-O-5	1-3/4	4	PR-147807	Cyls after 11/68	26.62
	110013	P-O-7	1-3/4	4	PR-147602	Cyls prior to 11/68	26.88
STABILIZER-TYPE 2 (Bolt On Head)	110121	P-V-7	2-1/2	4	PR-147621	Cyls after 11/68	40.04
	110121	P-V-5	2-1/2	4	PR-147821	Cyls prior to 11/68	48.09
STABILIZER-TYPE 4 (Bolt On Head)	110042	P-V-7	2	5	PR-147608	Cyls prior to 8/23/68	42.39
	110042	P-V-5	2	5	PR-147811	Cyls after 8/23/68	47.95
STICK BOOM	110212	P-V-1	2-1/2	-	PR-147513	S/N All	14.49
	110212	P-V-7	2-1/2	5	PR-147613	S/N Prior - 363	41.80
	110212	P-V-5	2-1/2	5	PR-147803	S/N 364 -->	52.00
SWING (400° Swing)	204507	I-N-5		5	PR-147817	S/N 371 - 495	55.65
	204507	N-N-9		5	PR-147629	S/N 496 -->	60.42
	204507	N-N-9		5	PR-147629	S/N Prior - 370	60.42
MODEL SERIES-H							
MAIN BOOM	110037	I-V-5	4	7	PR-147802	S/N 373 -->	68.72
	110037	I-V-7	4	7	PR-147606	S/N Prior - 372	98.07
STABILIZER-TYPE 1 (Bolt On Head)	110158	P-V-5	2-1/2	4	PR-147814		37.68
STABILIZER-TYPE 1 (Screw On Head)	110067	P-V-7	2-1/2	4	PR-147612	Cyls prior to 11/68	36.92
	110067	P-V-5	2-1/2	4	PR-147814	Cyls after 11/68	37.68
STICK BOOM	110218	P-V-1	2-1/2	6	PR-147514	S/N All	17.15
	110218	P-V-5	2-1/2	6	PR-147801	S/N All	53.49
MODEL SERIES-HBL							
KNUCKLE (Bolt On Head)	110102	P-V-7	1-3/4	4	PR-147627	Cyls prior to 11/68	36.80
	110102	P-V-5	2-1/2	4	PR-147830	Cyls after 11/68	37.68
KNUCKLE (Snap Ring Head)	110012	P-O-7	1-3/4	4	PR-147602	Cyls prior to 11/68	26.88
	110012	P-O-5	1-3/4	4	PR-147807	Cyls after 11/68	26.62
STABILIZER-TYPE 1 (Snap Ring Head)	110013	P-O-5	1-3/4	4	PR-147807	Cyls after 11/68	26.62
	110013	P-O-7	1-3/4	4	PR-147602	Cyls prior to 11/68	26.88
STABILIZER-TYPE 2 (Bolt On Head)	110121	P-V-7	2-1/2	4	PR-147621	Cyls after 11/68	40.04
	110121	P-V-5	2-1/2	4	PR-147821	Cyls prior to 11/68	48.09
STABILIZER-TYPE 4 (Bolt On Head)	110042	P-V-5	2	5	PR-147811	Cyls after 8/23/68	47.95
	110042	P-V-7	2	5	PR-147608	Cyls prior to 8/23/68	42.39
SWING (400° Swing)	204507	N-N-9		5	PR-147629	S/N 496 -->	60.42
	204507	I-N-5		5	PR-147817	S/N 371 - 495	55.65
	204507	N-N-9		5	PR-147629	S/N Prior - 370	60.42



REPLACEMENT KITS FOR PRENTICE EQUIPEMENT

Kit Number	Code (Pg. x)	Rod X Bore Size	List Price
PR-147100	I-U-13	1-1/2 X 3	\$ 22.97
PR-147101	I-U-13	2-1/2 X 4-1/2	33.87
PR-147102	I-U-13	2-1/2 X 5-1/2	52.29
PR-147103	I-U-11	1-1/4 X 2-1/2	18.54
PR-147108	I-U-11	4-1/2 X 8	113.07
PR-147109	I-OB-1	3/4 Rod Kit	3.18
PR-147110	I-U-11	2-1/2 X 4	33.57
PR-147111	I-U-11	4 X 6	53.00
PR-147282	P-U-5	2 X 3-1/2	15.67
PR-147504	I-V-0	4" Rod Kit	16.32
PR-147505	I-V-1	4 X 6	15.51
PR-147506	I-V-0	4" Rod Kit	18.37
PR-147508	P-V-1	2" Rod Kit	14.78
PR-147509	P-V-1	1-3/4" Rod Kit	14.61
PR-147510	P-V-2	1-3/4 X 4-1/2	14.67
PR-147513	P-V-1	2-1/2 X 5	14.49
PR-147514	P-V-1	2-1/2 X 6	17.15
PR-147515	P-V-1	1-1/2 X 3-1/2	19.73
PR-147522	P-V-0	2-1/2" Rod Kit	15.37
PR-147530	P-V-1	1-3/4 X 4	17.26
PR-147532	I-U-1	4" Rod Kit	22.97
PR-147600	P-O-7	1-1/2 X 3-1/2	23.73
PR-147602	P-O-7	1-3/4 X 4	26.88
PR-147603	P-V-7	2 X 4-1/2	33.26
PR-147604	I-V-7	4-1/4 X 5	69.78
PR-147605	I-V-7	4 X 6	51.19
PR-147606	I-V-7	4 X 7	98.07
PR-147608	P-V-7	2 X 5	42.39
PR-147609	P-V-7	1-3/4 X 4	34.11
PR-147612	P-V-11	2-1/2 X 4	36.92
PR-147613	P-V-7	2-1/2 X 5	41.80
PR-147615	N-N-9	4" Piston Kit	34.41
PR-147616	N-N-9	5" Piston Kit	65.77
PR-147617	I-V-9	4 X 5	74.74
PR-147618	P-O-1	1" Rod Kit	6.94
PR-147619	P-V-7	1-1/2 X 3-1/2	29.91
PR-147621	P-V-11	2-1/2 X 4-1/2	40.04
PR-147627	P-V-11	1-3/4 X 4	36.80
PR-147628	I-N-9	4" Piston Kit	47.17
PR-147629	I-N-9	5" Piston Kit	60.42
PR-147703	Rotary Actuator		10.49
PR-147729	I-U-5	4 X 7	74.04
PR-147731	P-V-5	2-1/2 X 5	41.11
PR-147732	I-V-5	4 X 6	61.19
PR-147733	I-V-5	4 X 7	53.41
PR-147734	I-U-5	4 X 6	58.09
PR-147735	P-V-5	2 X 5	51.84
PR-147736	P-V-5	1-3/4 X 3-1/2	29.51
PR-147738	Rotary Actuator Kit	2 X 6-3/4	41.87
PR-147740	P-V-5	1-3/4 X 4	37.68

Kit Number	Code (Pg. x)	Rod X Bore Size	List Price
PR-147746	I-U-5	2-1/2 X 5	\$ 51.00
PR-147747	P-U-5	2 X 5	49.19
PR-147748	I-U-5	4 X 7	74.78
PR-147750	PUMP KIT		102.59
PR-147751	I-U-5	2-1/2 X 4	31.64
PR-147752	P-U-5	1-3/4 X 4	31.21
PR-147753	I-U-5	1-1/2 X 3-1/2	25.10
PR-147754	P-U-5	1-3/4 X 3-1/2	24.36
PR-147763	I-U-11	2-1/2 X 5	65.84
PR-147765	I-U-11	4 X 7	88.03
PR-147766	I-U-11	2-1/2 X 4	25.26
PR-147769	I-U-11	4 X 7	76.61
PR-147770	I-U-11	2 X 3-1/2	43.07
PR-147771	I-U-11	2-1/2 X 4	48.69
PR-147780	I-U-11	2-1/2 X 5	41.81
PR-147781	I-U-11	4 X 6	53.00
PR-147782	I-U-11	4 X 7	88.03
PR-147783	I-U-11	4-1/2 X 8	118.07
PR-147786	I-U-11	3 X 6	63.55
PR-147788	I-U-11	1-1/2 X 3-1/2	34.04
PR-147794	I-U-11	4 X 7	76.61
PR-147800	I-V-5	4 X 6	50.72
PR-147801	P-V-5	2-1/2 X 6	53.49
PR-147802	I-V-5	4 X 7	68.72
PR-147803	P-V-5	2-1/2 X 5	52.00
PR-147804	P-V-5	1-3/4 X 4-1/2	39.24
PR-147807	P-O-5	1-3/4 X 4	26.62
PR-147808	P-V-5	2 X 4-1/2	40.09
PR-147809	I-V-5	4 X 5	53.53
PR-147810	P-V-5	1-3/4 X 3-1/2	36.70
PR-147811	P-V-5	2 X 5	47.95
PR-147812	P-V-5	1-3/4 X 4	29.84
PR-147813	P-V-5	1-1/2 X 3-1/2	20.08
PR-147814	P-V-5	2-1/2 X 4	37.68
PR-147815	P-V-5	2-1/2 X 6	55.12
PR-147816	I-N-5	4" PISTON KIT	26.81
PR-147817	I-N-5	5" PISTON KIT	55.65
PR-147819	P-V-5	1-1/2 X 3-1/2	29.30
PR-147821	P-V-5	2-1/2 X 4-1/2	48.09
PR-147826	P-V-1	2-1/2 X 7	18.97
PR-147828	P-U-5	2 X 3-1/2	15.67
PR-147829	P-U-5	1-3/4 X 3	36.78
PR-147830	P-V-5	1-3/4 X 4	37.68
PR-147831	P-V-5	2-1/2 X 6	52.33
PR-147832	I-U-5	4 X 7	72.43
PR-147833	I-U-5	2-1/2 X 6	54.11
PR-147834	I-U-5	4 X 6	55.46
PR-147835	I-V-5	4 X 7	76.59
PR-147836	I-V-5	4 X 6	51.01
PR-147842	P-V-5	1-3/4 X 4	37.68

REPLACEMENT KITS FOR PRENTICE EQUIPEMENT

Kit Number	Code (Pg. x)	Rod X Bore Size	List Price
PR-147849	P-V-5	2 X 5	\$ 61.78
PR-147857	P-V-5	2-1/2 X 4	40.25
PR-147858	I-V-5	4 X 6	54.81
PR-563594	I-U-1	1" Rod Kit	25.84
PR-30007033	P-U-14	2-1/2 X 5	129.32
PR-30007301	P-U-14	2-1/2 X 5	107.06
PR-10028680	I-U-11	2 x 3-1/2	21.45
PR-10032263	I-U-11	1-1/2 X 3	34.63
PR-10032264	I-U-11	1-1/2 X 3-1/2	30.15
PR-10032265	I-U-11	2 X 3-1/2	34.39
PR-10032266	I-U-11	2 X 4	39.93

Kit Number	Code (Pg. x)	Rod X Bore Size	List Price
PR-10032267	I-U-11	2-1/2 X 4	\$ 33.27
PR-10032268	I-U-11	2-1/2 X 4-1/2	49.23
PR-10032269	I-U-11	2-1/2 X 5	58.12
PR-10032270	I-U-11	3 X 5	61.54
PR-10032274	I-U-11	3 X 6	63.95
PR-10034620	I-U-11	2-1/2 X 4	33.27
PR-10034622	I-U-11	2-1/2 x 5	61.27
PR-10034624	I-U-11	3 X 6	63.95
PR-10034628	I-U-5	4 X 6	84.86
PR-10034629	I-U-11	4 X 6	93.61
PR-10034630	I-U-11	4 X 7	107.92

PRINCE

Kit Number	Code (Pg. x)	Rod X Bore Size	List Price
PC-10200	I-OB-5	1-1/4 X 2-3/8	\$ 21.57
PC-19700	I-U-10	1-3/8 X 3	14.68
PC-31841	I-U-10, 12	1-3/4 X 6	84.80
PC-31842	I-U-10, 12	2 X 6	84.42
PC-A807	P-V-9	2 X 5	56.30
PC-D1192	P-O-3, 12	1-3/8 X 3-1/4	25.94
PC-F-1121	I-OB-10	1-3/4 X 4	7.39
PC-F-1122	I-OB-10	1-3/4 X 3	9.67
PC-F237	I-OB-12	3 X 7	90.00
PC-G476	I-OB-3, 12	2 X 6	23.53
PC-H304	I-N-4	2-3/8, 3-3/8, 4-3/8 Stages	42.16
PC-H346	I-U-1	2-3/8, 3-3/8 Stages	27.33
PC-J1335	I-U-12	4-1/2 X 6	92.07
PC-J421	I-U-10, 12	1-1/2 X 3	39.56
PC-K1215	I-U-4	3, 4-1/2 Stages	79.64
PC-M387	I-U-3, 12	2-1/2 X 3-1/2	23.78
PMCK-10000	I-U-5	3 X 6	85.57
PMCK-19400	I-U-10	3/4 X 1-1/2	13.03
PMCK-19500	I-U-10	1-1/8 X 2	12.99
PMCK-19900	I-U-10	1-3/4 X 4	19.94
PMCK-21000	I-U-10	2-1/2 X 5	44.45
PMCK-22000	I-U-10	3 X 6	57.56

Kit Number	Code (Pg. x)	Rod X Bore Size	List Price
PMCK-35000	I, P-U-13	2 X 5	\$ 36.25
PMCK-42000	I-U-13	1-1/8 X 2	16.32
PMCK-43000	I-U-13	1-3/8 X 3	20.21
PMCK-43500	I-U-13	1-1/2 X 3-1/2	23.19
PMCK-44000	I-U-11	1-3/4 X 4	25.91
PMCK-5400	I-OB-3, 12	1-3/8 X 2-1/2	14.68
PMCK-5500	I-OB-3, 12	1-1/2 X 3-1/2	19.15
PMCK-5600	I-OB-3, 12	2 X 4	24.70
PMCK-7000	I-U-3	1-1/8 X 2-1/2	10.64
PMCK-7100	I-U-3	1-1/8 X 3	12.05
PMCK-8300	I-OB-3, 12	1-1/2 X 3	16.91
PMCK-8400	I-U-11	1 X 2	21.63
PMCK-9000	I-U-3	1-1/8 X 2	9.96
PMCK-9100	I-U-3	1-1/4 X 2-1/2	10.82
PMCK-9200	I-U-3	1-3/8 X 3	12.14
PMCK-9300	I-U-3	1-3/8 X 3-1/2	12.20
PMCK-9400	I-U-3	1-3/4 X 4	18.29
PMCK-9500	I-U-3	2 X 5	19.67
PMCK-9900	I-U-5	2-1/2 X 5	69.13
PMCK-AA-606	I-U-5	1-1/2 X 4	30.68
PMCK-AD414	I-U-13	2-1/2 X 4	24.38
PMCK-AF962	I-U-13	2-1/2 X 4	25.11



RAYMOND LIFT TRUCKS

Kit Number	Rod X Bore Size	Rod X Bore Size	List Price
RAY-400-148-01	O-RING KIT		\$ 3.50
RAY-500-412-02	O-RING KIT		6.14
RAY-520-038-12	O-RING KIT		3.50
RAY-520-044-01	O-RING KIT		3.50
RAY-520047004	P-U-10	3/4 X 1-3/4	22.28
RAY-520-053-01	O-RING KIT		3.50
RAY-520-066-01	O-RING KIT		4.08
RAY-520-077-01	VALVE KIT		17.33
RAY-520-817-08	O-RING KIT		3.50
RAY-53072101	I-U-11	3/4 X 2-1/2	14.35
RAY-530-722-02	I-U-11	1 X 2-1/2	14.65
RAY-53072702	P-U-1	1-3/4	70.37
RAY-53073101	I-U-11	1-1/4 X 2-1/2	14.58
RAY-53073102	I-U-11	1-1/4 X 3	20.70
RAY-54004105	P-OB-10	3/4 X 1-3/4	27.13
RAY-540041105	P-OB-10	3/4 X 1-3/4	18.89
RAY-540-043-07	P-OB-10	3/4 X 1-3/4	24.35
RAY-540-046-05	P-OB-10	3/4 X 1-3/4	34.91
RAY-540067214	I-U-13	1-3/4 X 3-1/2	31.81
RAY-540113269	I-U-13	1-3/4 X 3-1/2	23.90
RAY-870-460-217	VALVE KIT		11.15
RAY-870-607-26	VALVE KIT		6.06

RED LION TIE-ROD CYLINDERS

Kit Number	Code (Pg. x)	Rod X Bore Size	List Price
RL-492901	P-OB-3	1-1/8 X 2	\$ 6.61
RL-492903	P-OB-3	1-1/8 X 2-1/2	7.02
RL-492907	P-OB-3	1-1/4 X 3	7.41
RL-492911	P-OB-3	1-1/4 X 3-1/2	7.81
RL-492915	P-OB-3	1-1/4 X 4	8.48
RL-RK-20TR-112	P-OB-3	1-1/8 X 2	9.51

REYNOLDS SCRAPER

Kit Number	Rod X Bore Size	Rod X Bore Size	List Price
RE-1020306	I-U-10,12	2 X 6	\$ 69.10
RE-1020878	I-U-10,12	2 X 6	68.18
RE-1020879	I-U-10,12	2 X 3-1/2	27.92
RE-1023060	I-U-10,12	2-1/2 X 6	72.12

REYNOLDS SCRAPER

Kit Number	Rod X Bore Size	Rod X Bore Size	List Price
RE-7040H012	I-U-10,12	1-1/2 X 3-1/2	\$ 26.43
RE-7040H012NPR	I-U-10	1-1/2 X 3-1/2	12.19
RE-7040H014	I-U-10,12	1-1/2 X 3	26.75
RE-7040H014NPR	I-U-10	1-1/2 X 3	11.76
RE-7040H017	I-U-10	2 X 3-1/2	25.77
RE-7040H017NPR	I-U-10	2 X 3-1/2	11.37
RE-7040H019	I-U-10,12	1-3/4 X 4	31.79
RE-7040H019NPR	I-U-10	1-3/4 X 4	13.60
RE-7040H022	I-U-10,12	1-1/2 X 4	21.01
RE-7040H022NPR	I-U-10	1-1/2 X 4	12.99
RE-7040H023	I-U-10,12	2 X 5	48.24
RE-7040H023NPR	I-U-10	2 X 5	16.50
RE-7040H026	I-U-10,12	1-1/2 X 2-1/2	25.69
RE-7040H026NPR	I-U-10	1-1/2 X 2	11.08

RONEN

Kit Number	Cylinder	Code (Pg. x)	Rod X Bore Size	List Price
RO-3.5K	GRAPPLE CYL.	2 X 3-1/2	P-U-10	\$ 31.12
RO-4.0K	SHEAR CYL.	2 X 4	I-U-5	31.39
RO-5.0K	BOOM CYL.	2-1/2 X 5	P-U-5	55.12
RO-6.0K	BOOM CYL.	2-1/2 X 6	P-U-5	62.95
RO-7.0K	BOOM CYL.	3 X 7	P-U-5	77.08
RO-PK-4		2 X 4	P-U-10	35.53
RO-PK-5		2-1/2 X 5	P-U-10	53.18
RO-PK-6		3 X 6	P-U-10	62.08
RO-PK-7		3-1/2 X 7	P-U-10	90.67

ROTOBEC

Kit Number	Code (Pg. x)	Rod X Bore Size	List Price
RBC-096-2996	2 X 3-1/2	I-U-10	\$ 30.21
RBC-096-2997	2 X 4	I-U-10	32.80
RBC-096-3265	2-1/2 X 4	I-U-10	62.07
RBC-096-3801			3.56
RBC-097-3007			37.07
RBC-097-3010			28.81
RBC-097-4031			40.02
RBC-097-4276			5.77

SAMSUNG

Kit Number	Code (Pg. x)	Rod X Bore Size	List Price
SAM-8048-00070	P-UB-14	80 X 120 mm	\$ 237.78
SAM-8048-00130	P-UB-14	105 X 160 mm	252.33
SAM-8048-00150	P-UB-14	105 X 150 mm	269.64
SAM-8130-00420	P-UB-14	95 X 140 mm	125.61

SKYJACK

Kit Number	Code (Pg. x)	Rod X Bore Size	List Price
SKY-105816	I-U-4	3/4 X 1-1/2	\$ 14.83

SNORKEL

Kit Number	Code (Pg. x)	Rod X Bore Size	List Price
SN-007-2833	P-U-5	1-3/4 X 3-1/2	\$ 45.50
SN-015-0555	P-U-11	1 X 2-1/2	20.73
SN-015-0557	P, I-U-10	1 X 2	12.19
SN-2012	I-OB-10	1 X 1-1/2	5.12
SN-2030-2	I-U-4	2-1/8 X 4	21.01
SN-2123	I-OB-10	2 X 5	12.47
SN-300752	P-U-1	2-1/2 Rod Kit	14.59
SN-44000-4	I-V-1	1-1/4 Rod Kit	10.14
SN-45540-6		2-5/8 , 3-1/2 Stages	35.25
SN-45540-6N		1-3/4 X 3-1/2 2 Stage	33.58
SN-46102-6N		1-3/4 X 3-1/2 2 Stage	36.79
SN-467066	I-U-1	2 Stage 3, 3-1/2	56.18
SN-47514-4	I, P-OB-3	5/8 X 1-1/2	9.47
SN-4772866		3, 3-1/2 Stages	48.55
SN-48798-6		3 Stage 2-1/4, 3, 3-1/2	98.01
SN-48801-6		1-1/8, 2-5/8, 3-1/2 Stages	61.02
SN-55269-4	I-U-3	1 X 1-1/2	14.66
SN-56359-6	I-U-10, 12	1 X 2	25.80
SN-58400-6	I-U-4	2-1/4 X 4	27.88
SN-60549-6	I-U-11,12	2 X 3	34.87
SN-60556-6	I-U-10,12	1-1/2 X 2-1/2	26.21
SN-62167-6	I-U-10,12	1-3/4 X 3-1/2	29.07
SN-62197-6	I-U-12,12	1-3/4 X 3-1/2	26.84
SN-A007-1478-A	I-U-5	1-3/4 X 2-1/2	31.60
SN-A007-1479-B	I-U-5	1-1/2 X 3	26.35
SN-A007-3286	I-U-10, 12	2-1/2 X 3-1/2	26.43
SN-A007-3857	I-U-11, 12	2-1/2 X 5	75.68
SN-C007-1486	N-U-11	1-3/4 X 3-1/2	15.52

STEELMASTER

Kit Number	Cylinder	Code (Pg. x)	Rod X Bore Size	List Price
SM-TBN		I-U-5	3 X 6	\$ 48.25
SM-TFC	Telescopic Boom Fork Cyl.	I-U-5	1-1/4 X 4-1/2	31.26
SM-TTC	Telescopic Trolley Cyl.	I-U-5	2-1/2 X 3-1/2	30.04

TAMROCK

Kit Number	Code (Pg. x)	Rod X Bore Size	List Price
TAMR-85069909	P-U-14	25 X 40 mm	\$ 49.88
TAMR-85577709	P-U-15	50 X 125 mm	131.18
TAMR-85711149	O-RING KIT		2.26
TAMR-87285619	I-UB-10	50 X 70 mm	246.62



TAKEUCHI

Replacement Kits For

TAKEUCHI

Excavators							
APPLICATION	CYL #	SERIAL #	CODE	ROD	BORE	KIT #	List \$
MODEL TB015							
ARM	19000-61400	1153001-	P-U-10	30 mm	55 mm	TAK-19000-58099	48.57
BLADE	19000-59200	1153001-	P-U-10	30 mm	55 mm	TAK-19000-53499	52.94
BOOM	19000-61200	1153001-	P-U-10	30 mm	55 mm	TAK-19000-61299	45.01
BUCKET	19000-61500	1153001-	P-U-10	30 mm	50 mm	TAK-19000-61599	43.16
BUCKET TEL. A.	19000-62700	1153001-	P-U-10	30 mm	55 mm	TAK-19000-51999	45.08
SPANNER	19000-59300	1153001-	P-U-10	30 mm	55 mm	TAK-19000-51999	45.08
SWING	19000-57700	1153001-	P-U-10	35 mm	60 mm	TAK-19000-53399	50.07
TELESCOPIC	19000-62900	1153001-	P-U-13	25 mm	40 mm	TAK-19000-62699	48.37
MODEL TB025							
ARM	19000-52500	1255001-	P-U-10	40 mm	70 mm	TAK-19000-43999	60.10
BLADE	19000-52700	1255001-	I-U-14	45 mm	85 mm	TAK-19000-44299	71.25
BOOM	19000-52300	1255001-	P-U-10	40 mm	75 mm	TAK-19000-43899	65.67
BOOM CABIN	19000-52400	1255001-	P-U-10	40 mm	75 mm	TAK-19000-43899	65.67
	19000-69900	1255001-	P-U-10	40 mm	75 mm	TAK-19000-43899	65.67
BUCKET	19000-52600	1255001-	I-U-14	35 mm	60 mm	TAK-19000-44099	53.67
SWING	19000-51300	1255001-	I-U-14	40 mm	75 mm	TAK-19000-46199	82.30
MODEL TB035							
ARM	19000-56200	1355001-	P-U-10	45 mm	80 mm	TAK-19000-54999	46.30
BLADE	19000-55100	1355001-	P-U-14	55 mm	100 mm	TAK-19000-55199	67.96
BOOM	19000-54700	1355001-	P-U-10	45 mm	85 mm	TAK-19000-54799	49.22
BOOM CABIN	19000-54800	1355001-	P-U-10	45 mm	85 mm	TAK-19000-54799	49.22
	19000-70100	1355001-	P-U-10	45 mm	85 mm	TAK-19000-54799	49.22
BUCKET	19000-56300	1355001-	P-U-10	40 mm	70 mm	TAK-19000-52099	60.35
SWING	19000-56100	1355001-	P-U-10	45 mm	80 mm	TAK-19000-54199	52.94
TELESCOPIC	19000-62000	1355001-	P-U-10	40 mm	65 mm	TAK-19000-62099	46.79
MODEL TB036							
ARM	19000-11400	36003-.1140	P-U-5	45 mm	80 mm	TAK-19000-05099	69.01
ARM EXT. ARM	19000-16000	36003-.1140	P-U-5	45 mm	80 mm	TAK-19000-05099	69.01
BLADE	19000-12400	36003-.1140	P-U-5	40 mm	70 mm	TAK-19000-12299	37.29
	19000-12500	36003-.1140	P-U-5	40 mm	70 mm	TAK-19000-12299	37.29
BOOM LH - New	19000-32500	36003-.1140	P-U-5	40 mm	70 mm	TAK-19000-11299	53.23
BOOM LH - Old	19000-11300	36003-.1140	P-U-5	40 mm	70 mm	TAK-19000-11299	53.23
BOOM RH - New	19000-32400	36003-.1140	P-U-5	40 mm	70 mm	TAK-19000-11299	53.23
BOOM RH - Old	19000-11299	36003-.1140	P-U-5	40 mm	70 mm	TAK-19000-11299	53.23
BUCKET	19000-35400	36003-.1140	P-U-5	40 mm	70 mm	TAK-19000-05199	52.37
EXTENSION	19000-37700	36003-.1140	I-U-5	40 mm	60 mm	TAK-19000-37799	38.33
SWING	19000-25100	36003-.1140	P-U-5	45 mm	80 mm	TAK-19000-39199	86.92
MODEL TB068							
ARM	19000-19600	68003-68914&68233-68242	P-U-5	65 mm	105 mm	TAK-19000-19699	94.91
	19000-26400	68243- ,68195-68232	P-U-5	65 mm	105 mm	TAK-19000-19699	94.91
BLADE LH	19000-16500	68003-68914&68233-68242	P-U-5	60 mm	100 mm	TAK-19000-16499	87.98
	19000-25900	68195-68232&68243-	P-U-5	60 mm	100 mm	TAK-19000-16499	87.98
BLADE RH	19000-16600	68003-68914&68233-68242	P-U-5	60 mm	100 mm	TAK-19000-16499	87.98
	19000-25800	68195-68232&68243-	P-U-5	60 mm	100 mm	TAK-19000-16499	87.98
BOOM LH	19000-26100	68195-68232&68243-68295	P-U-5	55 mm	85 mm	TAK-19000-16199	75.20
	19000-32900	68296,68596-	P-U-5	55 mm	85 mm	TAK-19000-16199	75.20
BOOM RH	19000-26200	68195-68232&68243-68295	P-U-5	55 mm	85 mm	TAK-19000-16199	75.20
	19000-32800	68296, 68596-	P-U-5	55 mm	85 mm	TAK-19000-16199	75.20

Replacement Kits For

TAKEUCHI

Excavators							
APPLICATION	CYL #	SERIAL #	CODE	ROD	BORE	KIT #	List \$
MODEL TB068							
BUCKET	19000-26000	68195-68232&68243-	P-U-5	55 mm	90 mm	TAK-19000-16399	77.27
SWING	19000-26300	63203-	P-U-5	60 mm	100 mm	TAK-19000-16499	87.98

REPLACEMENT KITS FOR TAKEUCHI JAPANESE EXCAVATOR

Kit Number	Code (Pg. x)	Rod X Bore Size	List Price	Kit Number	Code (Pg. x)	Rod X Bore Size	List Price
TAK-03315-06199	P-08-1	35 mm Rod Kit	\$ 17.16	TAK-19000-51699	P-U-10	35 X 65mm	\$ 64.68
TAK-03515-04299	P-08-1	40 mm Rod Kit	10.73	TAK-19000-51899	P-U-10	35 X 63 mm	54.60
TAK-03715-01599	P-08-1	45 mm Rod Kit	8.82	TAK-19000-51999	P-U-10	30 X 55 mm	45.08
TAK-03915-04199	P-08-1	50 mm Rod Kit	14.24	TAK-19000-52099	P-U-10	40 X 70 mm	60.35
TAK-19000-00199	P-U-5	45 X 80 mm	41.81	TAK-19000-53399	P-U-10	35 X 60 mm	50.07
TAK-19000-00399	P-U-5	35 X 60 mm	29.81	TAK-19000-53499	P-U-10	30 X 55 mm	52.94
TAK-19000-00599	P-U-5	40 X 70 mm	29.72	TAK-19000-54199	P-U-10	45 X 80 mm	52.94
TAK-19000-02699	P-U-5	35 X 70 mm	36.55	TAK-19000-54399	P-U-10	40 X 75 mm	51.60
TAK-19000-04599	P-U-5	45 X 80 mm	56.26	TAK-19000-54499	P-U-10	35 X 65 mm	31.83
TAK-19000-04799	P-U-5	55 X 95 mm	51.20	TAK-19000-54799	P-U-10	45 X 85 mm	49.22
TAK-19000-04899	P-U-5	50 X 90 mm	57.77	TAK-19000-54999	P-U-10	45 X 80 mm	46.30
TAK-19000-04999	P-U-5	45 X 80 mm	49.46	TAK-19000-55199	P-U-14	55 X 100 mm	67.96
TAK-19000-05099	P-U-5	45 X 80 mm	69.01	TAK-19000-56999	P-U-10	25 X 50 mm	45.57
TAK-19000-05199	P-U-5	40 X 70 mm	52.37	TAK-19000-57199	P-U-10	25 X 50 mm	39.34
TAK-19000-09599	P-U-5	45 X 85 mm	50.39	TAK-19000-58099	P-U-10	30 X 55 mm	48.57
TAK-19000-09899	P-U-5	35 X 60 mm	42.08	TAK-19000-58199	P-U-10	40 X 65 mm	51.76
TAK-19000-09999	P-I-U-5	35 X 60 mm	46.19	TAK-19000-60699	I-U-14	35 X 60 mm	60.21
TAK-19000-10599	P-U-5	50 X 90 mm	47.67	TAK-19000-61299	P-U-10	30 X 55 mm	45.01
TAK-19000-11199	P-U-5	40 X 63 mm	53.18	TAK-19000-61599	P-U-10	30 X 50 mm	43.16
TAK-19000-11299	P-U-5	40 X 70 mm	53.23	TAK-19000-62099	P-U-10	40 X 65 mm	46.79
TAK-19000-11899	P-U-5	35 X 65 mm	53.61	TAK-19000-62699	P-U-13	25 X 40 mm	48.37
TAK-19000-12199	P-U-5	50 X 85 mm	62.08	TAK-19000-63499	P-UB-10	65 X 95 mm	104.07
TAK-19000-12299	P-U-5	40 X 70 mm	37.29	TAK-19000-63599	P-UB-10	55 X 85 mm	75.06
TAK-19000-13499	P-U-5	45 X 75 mm	88.67	TAK-19000-63699	P-UB-10	75 X 120 mm	124.41
TAK-19000-16199	P-U-5	55 X 85 mm	75.20	TAK-19000-63799	P-UB-10	60 X 100 mm	87.99
TAK-19000-16399	P-U-5	55 X 90 mm	77.27	TAK-19000-63999	P-U-1	60 X 110 mm	54.65
TAK-19000-16499	P-U-5	60 X 100 mm	87.98	TAK-19000-65199	P-UB-10	55 X 80 mm	87.86
TAK-19000-19699	P-U-5	65 X 105 mm	94.91	TAK-19000-70499	P-U-10	30 X 55 mm	36.63
TAK-19000-24599	P-U-5	40 X 70 mm	57.81	TAK-19000-70599	P-U-10	35 X 60 mm	54.53
TAK-19000-27399	P-U-5	53 X 100 mm	129.85	TAK-19000-72299	P-U-10	30 X 50 mm	40.28
TAK-19000-30599	P-U-5	45 X 75 mm	62.15	TAK-19000-75699	I-U-14	55 X 110 mm	93.28
TAK-19000-30699	P-U-5	45 X 75 mm	75.62	TAK-19000-75799	I-UB-14	50 X 90 mm	93.24
TAK-19000-37799	I-U-5	40 X 60 mm	38.33	TAK-19000-76399	P-UB-10	65 X 95 mm	77.85
TAK-19000-39199	P-U-5	45 X 80 mm	86.92	TAK-19000-77499	P-U-10	40 X 70 mm	32.86
TAK-19000-43899	P-U-14	40 X 75 mm	65.67	TAK-19000-78299	P-U-10	45 X 85 mm	57.43
TAK-19000-43999	I-U-14	40 X 70 mm	60.10	TAK-19000-78999	P-UB-10	55 X 80 mm	75.66
TAK-19000-44099	I-U-14	35 X 60 mm	53.67	TAK-19000-79399	P-UB-10	75 X 120 mm	109.71
TAK-19000-44299	I-U-14	45 X 85 mm	71.25	TAK-19000-79499	P-UB-10	60 X 100 mm	78.99
TAK-19000-46199	I-U-14	40 X 75 mm	82.30	TAK-19000-81599	P-U-10	50 X 90 mm	56.37
TAK-19000-47195	P-U-10	50 X 90 mm	46.64	TAK-19017-30599		O-RING KIT	.68
TAK-19000-47295	P-U-10	45 X 80 mm	44.30	TAK-19029-03199		O-RING KIT	1.64
TAK-19000-47695	P-U-10	55 X 100 mm	53.28				

Replacement Kits For

TCM

TCM

Wheel Loaders						
APPLICATION	CODE	ROD	BORE	KIT #	Bearings Needed	List \$
MODEL 720, 860						
BOOM	P-UB-10	75 mm	140 mm	TCM-26508-47011	MDU-75X80X30	168.45
BUCKET	P-UB-10	95 mm	190 mm	TCM-26608-57011	MDU-95X100X30	229.53
STEERING	P-UB-10	40 mm	80 mm	TCM-26604-57001		91.05
MODEL 870						
BUCKET	P-UB-10	95 mm	170 mm	TCM-26708-47001		327.72

REPLACEMENT KITS FOR TCM CONSTRUCTION EQUIPMENT

Kit Number	Code (Pg. x)	Rod X Bore Size	List Price
TCM-26438-57001	P-UB-10	70 X 130 mm	\$ 189.62
TCM-26508-47011	P-UB-10	75 X 140 mm	168.46
TCM-26604-57001	P-UB-10	40 X 80 mm	91.04

Kit Number	Code (Pg. x)	Rod X Bore Size	List Price
TCM-26608-57011	P-UB-10	95 X 190 mm	\$ 229.53
TCM-26708-47001	P-UB-10	95 X 170 mm	327.72

REPLACEMENT KITS FOR TCM LIFT TRUCKS

Kit Number	Code (Pg. x)	Rod X Bore Size	List Price
TCM-20804-59801	P-U-10	25 X 60 mm	\$ 35.00
TCM-210F0-89804	P-U-4	35 X 45 mm	64.19
TCM-210F8-49804	P-U-4	35 X 46 mm	44.59
TCM-214A0-59801	P-U-10	75 X 90 mm	74.67
TCM-214A0-59821	P-U-1	35 X 45 mm	39.30
TCM-214A0-89804	P-U-4	40 X 50 mm	44.92
TCM-214A4-59801	P-U-10	25 X 50 mm	33.10
TCM-214A8-49804	P-U-4	40 X 50 mm	52.04
TCM-214A8-49812	P-U-4	40 X 50 mm	54.51
TCM-214A8-59801	P-U-5	32 X 71 mm	92.78
TCM-214J0-59812	P-U-1	40 X 50 mm	52.65
TCM-214J8-49804	P-U-4	45 X 55 mm	52.53
TCM-214T0-89811	P-U-N	50 X 60 mm	68.43
TCM-214T8-49801	P-U-4	50 X 60 mm	65.56
TCM-22438-49811	P-N-4	60 X 90 mm	62.52
TCM-22438-49812	P-N-4	60 X 90 mm	30.18
TCM-22438-59804	P-U-5	40 X 90 mm	101.41
TCM-224T8-49803	P-U-N	50 X 65 mm	56.06
TCM-22578-49801	P-N-4	45 X 63 mm	63.42
TCM-22580-89801	P-N-4	45 X 70 mm	44.92
TCM-22678-59801	P-U-5	32 X 80 mm	53.33
TCM-228C0-59801	P-U-1	112 X 130 mm	216.29
TCM-23460-89801	P-N-4	50 X 90 mm	50.40
TCM-234A8-49803	P-U-4	40 X 50 mm	37.73
TCM-234A8-59805	P-U-5	30 X 71 mm	67.50
TCM-23650-59801	P-U-1	35 X 45 mm	46.59
TCM-23650-59802	P-U-1	35 X 45 mm	36.27
TCM-23650-89802	P-U-1	40 X 50 mm	45.09
TCM-23650-89803	P-N-4	40 X 50 mm	38.73
TCM-23650-89822	P-U-1	75 X 90 mm	70.24
TCM-23650-89841	P-U-N	40 mm	31.64

Kit Number	Code (Pg. x)	Rod X Bore Size	List Price
TCM-23654-52201	I-U-10	25 X 60 mm	\$ 28.03
TCM-23658-59811	P-U-5	32 X 70 mm	69.09
TCM-23658-59813	P-U-5	32 X 70 mm	69.09
TCM-23678-59801	P-U-5	32 X 71 mm	76.36
TCM-24239-49801	P-U-1	35 X 45 mm	48.93
TCM-24239-49804	P-U-1	35 X 45 mm	48.11
TCM-24240-89801	P-U-1	70 X 80 mm	40.61
TCM-24248-59802	P-U-5	30 X 63 mm	89.19
TCM-24248-59807	P-U-5	30 X 63 mm	61.46
TCM-24328-59804	P-U-5	50 X 100 mm	101.73
TCM-24450-89803	P-U-N	85 mm	45.73
TCM-24450-89823	P-U-4	45 X 50 mm	45.93
TCM-24458-59812	P-U-10	32 X 71 mm	98.07
TCM-24469-49803	P-U-4	45 X 55 mm	31.74
TCM-24600-89902	P-U-1	50 X 60 mm	90.18
TCM-24608-59803	P-U-10	50 X 90 mm	89.89
TCM-25594-59802	P-U-10	22 X 50 mm	38.63
TCM-25954-59802	P-U-10	25 X 60 mm	27.88
TCM-26094-17161	VALVE KIT		5.93
TCM-27248-49801	P-N-4	50 X 80 mm	57.93
TCM-27390-59801	P-U-10	70 X 80 mm	81.02
TCM-27390-59902	P-U-1	45 mm Rod Kit	65.12
TCM-27410-89811	P-U-N	70 mm	37.62
TCM-277H8-59802	P-U-5	30 X 63 mm	61.56
TCM-27830-89802	P-U-10	85 X 100 mm	99.30
TCM-510F0-59801	P-U-1	32 X 45 mm	55.75
TCM-510F2-40601	P-U-10	40 X 70 mm	144.71
TCM-514A2-40552	P-U-10	50 X 80 mm	151.55
TCM-514A2-42631	VALVE KIT		6.03
TCM-52486-09811	VALVE KIT		14.13

Replacement Kits For

TEREX

Scrapers						
APPLICATION	CYL #	CODE	ROD	BORE	KIT #	List \$
MODEL S23E						
STEERING	9066953	P-V-12	2-1/2	5-1/2	TX-15050390	53.53
	9066954	P-V-12	2-1/2	5-1/2	TX-15050390	53.53
MODEL S24						
APRON / EJECTOR	9217579	P-V-1	7.925	9-1/8	TX-15050409	185.38
BOWL	9217584	P-V-1	7.925	9-1/8	TX-15050409	185.38
STEERING	9062928	P-V-12	3	7	TX-15050396	84.79
MODEL S24B						
APRON	15014766	I-V-12	2-1/2	6-1/4	TX-15050394	61.00
	15016260	I-V-12	2-1/2	6-1/4	TX-15050394	61.00
BOWL	9272694	P-U-10	3-1/2	8	TX-15050399	126.54
EJECTOR	15015718	I-SP-12	4-1/2	7-1/2	TX-15050415	392.73
RIDE	9062425	I,P-U-12	7	8	TX-15050406	249.63
STEERING	15005121	P-V-12	3	7	TX-15050396	84.79
	15009641	P-V-12	3	7	TX-15050396	84.79
MODEL S24C						
APRON	15014766	I-V-12	2-1/2	6-1/4	TX-15050394	61.00
	15016260	I-V-12	2-1/2	6-1/4	TX-15050394	61.00
BOWL	9272694	P-U-10	3-1/2	8	TX-15050399	126.54
EJECTOR	15015718	I-SP-12	4-1/2	7-1/2	TX-15050415	392.73
STEERING	15005121	P-V-12	3	7	TX-15050396	84.79
	15009641	P-V-12	3	7	TX-15050396	84.79
MODEL TS14						
APRON / EJECTOR	9217579	P-V-1	7.925	9-1/8	TX-15050409	185.38
BOWL	9005146	P-V-1	7.925	9-1/8	TX-15050409	185.38
	9217584	P-V-1	7.925	9-1/8	TX-15050409	185.38
MODEL TS14B						
APRON / EJECTOR	9217579	P-V-1	7.925	9-1/8	TX-15050409	185.38
BOWL	9005146	P-V-1	7.925	9-1/8	TX-15050409	185.38
STEERING	9066951	P-V-12	2-1/2	5-1/2	TX-15050390	53.53
	9066952	P-V-12	2-1/2	5-1/2	TX-15050390	53.53
	9382500	P-U-12	2-1/2	5-1/2	TX-9397201	286.20
	9382501	P-U-12	2-1/2	5-1/2	TX-9397201	286.20
MODEL TS14C						
APRON / EJECTOR	9217579	P-V-1	7.925	9-1/8	TX-15050409	185.38
BOWL	15007421	P-U-10	3-1/2	8	TX-15050399	126.54
STEERING	9382500	P-U-12	2-1/2	5-1/2	TX-9397201	286.20
	9382501	P-U-12	2-1/2	5-1/2	TX-9397201	286.20
MODEL TS18A						
APRON	9217579	P-V-1	7.925	9-1/8	TX-15050409	185.38
MODEL TS24						
APRON / EJECTOR	9217579	P-V-1	7.925	9-1/8	TX-15050409	185.38
BOWL	9217584	P-V-1	7.925	9-1/8	TX-15050409	185.38
STEERING	15009641	P-V-12	3	7	TX-15050396	84.79
	9062928	P-V-12	3	7	TX-15050396	84.79
MODEL TS24A						
APRON	15014766	I-V-12	2-1/2	6-1/4	TX-15050394	61.00
	15016260	I-V-12	2-1/2	6-1/4	TX-15050394	61.00
	15016261	I-V-12	2-1/2	6-1/4	TX-15050394	61.00

Replacement Kits For

TEREX

TEREX - TIGERCAT

Scrapers						
APPLICATION	CYL #	CODE	ROD	BORE	KIT #	List \$
MODEL TS24A						
STEERING	15005121	P-V-12	3	7	TX-15050396	84.79
	15009641	P-V-12	3	7	TX-15050396	84.79
	9062928	P-V-12	3	7	TX-15050396	84.79
MODEL TS24B						
APRON	15014766	I-V-12	2-1/2	6-1/4	TX-15050394	61.00
	15016260	I-V-12	2-1/2	6-1/4	TX-15050394	61.00
BOWL	9272694	P-U-10	3-1/2	8	TX-15050399	126.54
EJECTOR	15015718	I-SP-12	4-1/2	7-1/2	TX-15050415	392.73
RIDE	9062425	I,P-U-12	7	8	TX-15050406	249.63
STEERING	15005121	P-V-12	3	7	TX-15050396	84.79
	15009641	P-V-12	3	7	TX-15050396	84.79
	9062928	P-V-12	3	7	TX-15050396	84.79
MODEL TS24C						
APRON	15014766	I-V-12	2-1/2	6-1/4	TX-15050394	61.00
	15016260	I-V-12	2-1/2	6-1/4	TX-15050394	61.00
BOWL	9272694	P-U-10	3-1/2	8	TX-15050399	126.54
EJECTOR	15015718	I-SP-12	4-1/2	7-1/2	TX-15050415	392.73
STEERING	15005121	P-V-12	3	7	TX-15050396	84.79
	15009641	P-V-12	3	7	TX-15050396	84.79

TEREX

Kit Number	Code (Pg. x)	Rod X Bore Size	List Price
TX-15050390	P-V-12	2-1/2 X 5-1/2	\$ 53.53
TX-15050394	I-V-12	2-1/2 X 6-1/4	61.00
TX-15050396	P-U-12	3 X 7	84.79
TX-15050399	P-U-10	3-1/2 X 8	126.54
TX-15050406	I, P-U-12	7 X 8	249.63
TX-15050409	P-V-1	7.925 Rod Kit	185.38
TX-15050415	I-SP-12	4-1/2, 6, 7-1/2 STAGES	392.73
TX-15050416	I-U-12	5-1/4, 6-3/4" Stages	136.56

Kit Number	Code (Pg. x)	Rod X Bore Size	List Price
TX-15921417		Valve Kit	\$ 5.80
TX-3307F	I-U-1	7" Rod Front Suspension	85.47
TX-3307R	I-U-1	8-1/4" Rod Rear Suspension	88.02
TX-3307SC	I-U-12	1-3/4 X 3-1/4	28.46
TX-3311HC	I-U-12	6-3/4 X 8-1/4	172.39
TX-607325	P-V-12	3 X 7	90.00
TX-9397201	P-U-12	2-1/2 X 5-1/2	286.20
TX-TS24EJ	I-V-1	4, 5-3/4, 7-1/2 Tele	222.67

TIGERCAT

Replacement Kits For

Feller Bunchers					
APPLICATION	CODE	ROD	BORE	KIT #	List \$
MODEL 720, 726					
LIFT	P-U-4	1-3/4	3	TGC-90004	57.31
STEERING	P-U-4	2-1/2	4-1/2	TGC-90006	76.17
TILT	P-U-4	1-3/4	3	TGC-90004	57.31

TIGERCAT

Kit Number	Code (Pg. x)	Rod X Bore Size	List Price
TGC-90004	P-U-4	1-3/4 X 3	\$ 57.31
TGC-90006	P-U-4	2-1/4 X 4-1/2	76.17

Replacement Kits For

TIMBERJACK

TIMBERJACK

Log Loaders							
APPLICATION	CYL #	SERIAL #	CODE	ROD	BORE	KIT #	List \$
MODEL 330							
JIB BOOM			I-U-10	3	7	TBJ-842937500	41.67
MAIN BOOM			I-U-10	3	6	TBJ-842936800	51.68
STABILIZER			I-U-10	3	6	TBJ-842936800	51.68
MODEL 430							
JIB BOOM			I-U-10	3-1/2	7	TBJ-842938200	60.29
MAIN BOOM			I-U-10	3	6	TBJ-842936800	51.68
STABILIZER			I-U-10	3	6	TBJ-842936800	51.68
Skidders							
APPLICATION	CYL #	SERIAL #	CODE	ROD	BORE	KIT #	List \$
MODEL 240							
DOZER	8256787		P-U-10	1-3/4	4	TBJ-231384700	34.50
STEERING	2313806		I-U-10	2	4-1/2	TBJ-231383200	81.47
	2313816		P-U-10	1-3/4	4	TBJ-231384700	34.50
MODEL 240A							
ARCH-SINGLE	8259164		P-U-10	1-3/4	4	TBJ-231384700	34.50
	8268592		P-U-10	1-3/4	4	TBJ-845167600	54.99
DOZER	8260240		P-U-10	1-3/4	4	TBJ-231384700	34.50
GRAPPLE	8427905		1-U-5	2	4	TBJ-843010000	37.24
STEERING	2313806		I-U-10	2	4-1/2	TBJ-231383200	81.47
	8268602		P-U-10	2	4-1/2	TBJ-845167700	71.75
MODEL 240B							
ARCH-SINGLE	8268592		P-U-10	1-3/4	4	TBJ-845167600	54.99
DOZER	8268597		P-U-10	1-3/4	4	TBJ-845167600	54.99
	8268597		P-U-10	1-3/4	4	TBJ-845167600	54.99
GRAPPLE	8419398		I-U-5	2-1/2	4	TBJ-842249600	66.54
	8427905		1-U-5	2	4	TBJ-843010000	37.24
	F431703		P-UB-10	2	4	TBJ-F434195	78.99
	F431737		P-UB-10	2-1/2	4	TBJ-F434787	87.57
STEERING	8268602		P-U-10	2	4-1/2	TBJ-845167700	71.75
MODEL 360							
ARCH	F120710		I-UB-1	50 mm		TBJ-F432351	32.00
	F120710		N-N-14		100 mm	TBJ-842884100	52.34
DOZER	F120975		P-UB-1	45 mm		TBJ-F433400	44.81
	F120975		N-N-14		90 mm	TBJ-F434056	42.99
GRAPPLE	F431737		P-UB-10	2-1/2	4	TBJ-F434787	87.57
	F431738		P-UB-10	2-1/2	4-1/2	TBJ-F434785	94.67
	F434169		P-UB-10	2	4	TBJ-F434195	78.99
	F434381		P-UB-10	2	4	TBJ-F434195	78.99
STEERING	F120975		P-UB-1	45 mm		TBJ-F433400	44.81
	F120975		N-N-14		90 mm	TBJ-F434056	42.99
MODEL 380, 380A, 380B							
ARCH	2315925		I-U-10	1-3/4	3-1/2	TBJ-845089800	61.65
ARCH-DUAL	2315925		I-U-10	1-3/4	3-1/2	TBJ-845089800	61.65
ARCH-SINGLE	8256796		I-U-10	1-3/4	4	TBJ-845109500	64.62
BOOM	2315925		I-U-10	1-3/4	3-1/2	TBJ-845089800	61.65
DOZER	8256792		I-U-10	1-3/4	3-1/2	TBJ-231385100	57.81
GRAPPLE	8245558		I-U-10	2-1/2	5-1/2	TBJ-845089900	82.61
	8414685		I-U-10	2-1/2	5	TBJ-841468700	28.98

Replacement Kits For

TIMBERJACK

TIMBERJACK

Skidders								
APPLICATION	CYL #	SERIAL #	CODE	ROD	BORE	KIT #	List \$	
MODEL 380, 380A, 380B								
GRAPPLE	8417552		I-U-5	2-1/2	4	TBJ-842249600	66.54	
	8419223		I-U-10	3-1/2	6-1/2	TBJ-841923200	46.03	
	8419398		I-U-5	2-1/2	4	TBJ-842249600	66.54	
	8419398		I-U-5	2-1/2	4	TBJ-842249600	66.54	
N/A	2313814		I-U-10	1-3/4	3-1/2	TBJ-231385100	57.81	
STEERING	8256798		I-U-10	1-3/4	3-1/2	TBJ-231385100	57.81	
MODEL 380, 450C								
ARCH-DUAL	8268601		P-U-10	1-3/4	4	TBJ-845167400	56.14	
ARCH-SINGLE	8268593		P-U-10	1-3/4	4	TBJ-845167600	54.99	
BOOM	8268601		P-U-10	1-3/4	4	TBJ-845167400	56.14	
DOZER	8268596		P-U-10	1-3/4	4	TBJ-845167600	54.99	
GRAPPLE	8268600		P-U-10	1-3/4	4	TBJ-845167400	56.14	
	8419411		I-U-10	2-1/2	5	TBJ-843009800	56.24	
	8424465	10650-14999	I-U-5	2-1/2	4	TBJ-842249600	66.54	
	8425715		I-U-5	2-1/2	4-1/2	TBJ-843011300	42.46	
	8427905		1-U-5	2	4	TBJ-843010000	37.24	
	8428962		I-U-10	2-1/2	5-1/2	TBJ-843009900	82.61	
	F431703		P-UB-10	2	4	TBJ-F434195	78.99	
	F431737		P-U-10	2-1/2	4	TBJ-843113700	71.75	
	F431738		P-UB-10	2-1/2	4-1/2	TBJ-F434785	94.67	
	GRAPPLE T.J. 105"	8247956		I-U-10	2-1/2	5-1/2	TBJ-845089900	82.61
	STEERING	8268599		P-U-10	1-3/4	4	TBJ-845167400	56.14
	MODEL 450							
ARCH	2315925		I-U-10	1-3/4	3-1/2	TBJ-845089800	61.65	
	8244039		I-U-10	1-3/4	4	TBJ-845109500	64.62	
	8256796		I-U-10	1-3/4	4	TBJ-845109500	64.62	
ARCH-DUAL	2315925		I-U-10	1-3/4	3-1/2	TBJ-845089800	61.65	
ARCH-SINGLE	8256796		I-U-10	1-3/4	4	TBJ-845109500	64.62	
BOOM	2315925		I-U-10	1-3/4	3-1/2	TBJ-845089800	61.65	
	8244039		I-U-10	1-3/4	4	TBJ-845109500	64.62	
	8256796		I-U-10	1-3/4	4	TBJ-845109500	64.62	
DOZER	8256792		I-U-10	1-3/4	3-1/2	TBJ-231385100	57.81	
GRAPPLE	8247955		I-U-10	1-3/4	4	TBJ-845109500	64.62	
	8414685		I-U-10	2-1/2	5	TBJ-841468700	28.98	
	8417552		I-U-5	2-1/2	4	TBJ-842249600	66.54	
	8419223		I-U-10	3-1/2	6-1/2	TBJ-841923200	46.03	
	8419224		I-U-10	3-1/2	6-1/2	TBJ-841923200	46.03	
	8419398		I-U-5	2-1/2	4	TBJ-842249600	66.54	
	8424465		I-U-5	2-1/2	4	TBJ-842249600	66.54	
	GRAPPLE T.J.105"	8247956		I-U-10	2-1/2	5-1/2	TBJ-845089900	82.61
	N/A	2313814		I-U-10	1-3/4	3-1/2	TBJ-231385100	57.81
	STEERING	8256798		I-U-10	1-3/4	3-1/2	TBJ-231385100	57.81
MODEL 460								
ARCH-DUAL	F120977		N-N-14		90 mm	TBJ-F434056	42.99	
	F120977		P-UB-1	45 mm		TBJ-F433400	44.81	
ARCH-SINGLE	F120710		I-UB-1	50 mm		TBJ-F432351	32.00	
	F120710		N-N-14		100 mm	TBJ-842884100	52.34	
BOOM	F122026		I-UB-1	50 mm		TBJ-F432351	32.00	

Replacement Kits For

TIMBERJACK

Skidders							
APPLICATION	CYL #	SERIAL #	CODE	ROD	BORE	KIT #	List \$
MODEL 460							
BOOM	F122026		N-N-14		90 mm	TBJ-F434056	42.99
CAB TILT	8119718		N-O-1			TBJ-F033365	3.07
DOZER	F120709		N-N-14		100 mm	TBJ-842884100	52.34
	F120709		I-UB-1	50 mm		TBJ-F432351	32.00
GRAPPLE	F431737		P-UB-10	2-1/2	4	TBJ-F434787	87.57
	F431738		P-UB-10	2-1/2	4-1/2	TBJ-F434785	94.67
	F433137		P-UB-10	2-1/2	5-1/2	TBJ-F433145	110.97
	F433146		P-UB-10	2-1/2	5-1/2	TBJ-F433145	110.97
	F434169		P-UB-10	2	4	TBJ-F434195	78.99
	F434381		P-UB-10	2	4	TBJ-F434195	78.99
N/A	F122183		N-N-14		125 mm	TBJ-F434140	106.05
	F122183		P-UB-10	63 mm		TBJ-F433415	37.77
STEERING	F120975		N-N-14		90 mm	TBJ-F434056	42.99
	F120975		P-UB-1	45 mm		TBJ-F433400	44.81

REPLACEMENT KITS FOR TIMBERJACK EQUIPMENT

Kit Number	Code (Pg. x)	Rod X Bore Size	List Price	Kit Number	Code (Pg. x)	Rod X Bore Size	List Price
TBJ-231383200	I-U-10	2 X 4-1/2	\$ 69.90	TBJ-842936800	I-U-10	3 X 6	\$ 52.95
TBJ-231384700	I-U-1	1-3/4 X 4	34.50	TBJ-842937500	I-U-10	3 X 7	41.67
TBJ-231385100	I-U-10	1-3/4 X 3-1/2	57.81	TBJ-842938200	I-U-10	3-1/2 X 7	60.29
TBJ-41468700	I-U-10	2-1/2 X 5	22.69	TBJ-842961900	I-U-10	3-1/2 X 7	50.31
TBJ-41477400	P-U-5	2 X 4	27.70	TBJ-843009800	I-U-10	2-1/2 X 5	56.24
TBJ-41478200	I-U-5	1-1/2 X 3-1/2	19.05	TBJ-843009900	I-U-10	2-1/2 X 5-1/2	82.61
TBJ-42289700	I-U-4	2-1/2 X 4	43.71	TBJ-843010000	1-U-5	2 X 4	37.24
TBJ-450999	I-U-8	1 X 3-1/2	26.50	TBJ-843011300	I-U-5	2-1/2 X 4-1/2	42.46
TBJ-700797300	P-UB-10	2 X 4	48.23	TBJ-843032500	I-U-10	3 X 7	42.67
TBJ-700867900	P-UB-10	3 X 5	145.80	TBJ-843032800	I-U-10	3 X 6	55.89
TBJ-700884400	P-UB-14	3 X 5	148.40	TBJ-843113700	P-U-10	2-1/2 X 4	71.75
TBJ-841468700	I-U-10	2-1/2 X 5	28.98	TBJ-8431265	I-U-10	25 mm X 2 in	22.13
TBJ-8417516	I-U-10	2-1/2 X 5	55.71	TBJ-8450282	I-U-5	1-3/4 X 4-1/2	63.19
TBJ-841923200	I-U-10	3-1/2 X 6-1/2	46.03	TBJ-8450446	I-V-9	2 X 4-1/2	48.53
TBJ-842249600	I-U-5	2-1/2 X 4	66.54	TBJ-8450702	I-U-5	1-3/4 X 4	45.92
TBJ-842884100	N-N-14	100 mm	52.34	TBJ-8450703	I-U-5	1-3/4 X 4-1/2	49.46
TBJ-8429306	I-U-5	2-1/2 X 4	45.35	TBJ-8450704	I-U-5	2-1/2 X 6	70.12



TIMBERJACK

Kit Number	Code (Pg. x)	Rod X Bore Size	List Price
TBJ-8450705	I-U-5	2-1/2 X 4-1/2	\$ 55.59
TBJ-8450706	I-U-4	1 X 3-1/2	15.27
TBJ-8450709	I-U-12	1-3/4 X 4	38.79
TBJ-8450710	I-U-5	1-3/4 X 3-1/2	29.50
TBJ-845089800	I-U-10	1-3/4 X 3-1/2	61.65
TBJ-845089900	I-U-10	2-1/2 X 5-1/2	82.61
TBJ-845109500	I-U-10	1-3/4 X 4	64.62
TBJ-845167400	P-U-10	1-3/4 X 3-1/2	56.14
TBJ-845167600	P-U-10	1-3/4 X 4	54.99
TBJ-845167700	P-U-10	2 X 4-1/2	71.75
TBJ-F033365	N-O-N	-	3.07
TBJ-F305716	N-N-10	6,6-1/2 Bore	139.13
TBJ-F432351	I-UB-1	50 mm	32.00
TBJ-F433145	P-UB-10	2-1/2 X 5-1/2	110.97
TBJ-F433400	P-UB-1	45 mm	44.81
TBJ-F433415	P-UB-10	63 mm	37.77
TBJ-F434056	N-N-14	90 mm	42.99
TBJ-F434140	N-N-14	125 mm	106.05
TBJ-F434195	P-UB-10	2 X 4	78.99
TBJ-F434785	P-UB-10	2-1/2 X 4-1/2	94.67
TBJ-F434787	P-UB-10	2-1/2 X 4	87.57

TOMPKINS-JOHNSON

Kit Number	Code (Pg. x)	Rod X Bore Size	List Price
TJ-28136862	N-TR-11	1 X 5	\$ 22.98
TJ-6331U-027	N-U-10	1-1/4 X 4	36.57
TJ-6332U-014	N-U-5	1 X 2-1/2	11.54
TJ-6332U-026	N-U-5	1 X 4	14.74
TJ-6332U-028	N-V-5	1-3/8 X 4	13.85
TJ-6332U-030	N-U-5	1-3/4 X 4	16.51
TJ-6332U-035	N-U-5	1 X 5	15.51
TJ-6332U-048	N-V-5	1-3/4 X 6	24.12
TJ-6332U-069	N-V-5	1-3/8 X 8	32.85
TJ-6332U-070	N-V-5	1-3/4 X 8	36.38

TOWMOTOR - CATERPILLAR® LIFT TRUCKS

FOR A LIST OF
TOWMOTOR / CATERPILLAR®
LIFT TRUCKS

SEE OUR LISTING OF KITS UNDER THE
CATERPILLAR® SECTION IN THIS CATALOG/

TOYOTA LIFT TRUCKS

Kit Number	Code (Pg. x)	Rod X Bore Size	List Price
TOY-04431-30091-71	P-U-5	60 X 90 mm	\$ 151.40
TOY-04433-10010-71	P-U-10	40 X 60 mm	62.85
TOY-04433-10020-71	P-U-10	40 X 60 mm	39.38
TOY-04433-20011-71	I-U-10	50 X 75 mm	135.56
TOY-04433-20030-71	I-U-10	50 X 80 mm	104.59
TOY-04433-U1010-71	I-U-10	40 mm X 2-3/8 in	31.30
TOY-04433-U2040-71	I-U-10	50 mm X 3 in	28.31
TOY-04433-U2050-71	I-U-10	50 mm X 3-1/8 in	116.55
TOY-04433-U3010-71	I-U-10	50 mm X 3-1/8 in	116.55
TOY-04451-10070-71	P-V-12	22 X 40 mm	43.81
TOY-04451-10090-71	P-V-12	22 X 40 mm	48.48
TOY-04451-10120-71	P-U-12	22 X 45 mm	45.21
TOY-04451-20100-71	P-V-12	22 X 50 mm	48.66
TOY-04451-20101-71	P-U-12	22 X 50 mm	49.41
TOY-04451-20170-71	P-V-12	22 X 50 mm	49.21
TOY-04451-20171-71	P-U-12	22 X 50 mm	49.41
TOY-04455-U2010-71	VALVE KIT		46.68
TOY-04456-10020-71	P-U-10	22 X 50 mm	30.85
TOY-04456-10031-71	P-U-5	30 X 55 mm	95.83
TOY-04456-10050-71	P-U-12	22 X 45 mm	40.88
TOY-04456-20010-71	P-U-12	22 X 40 mm	44.12
TOY-04456-20020-71	P-U-12	22 X 40 mm	43.91
TOY-04456-20030-71	N-U-12	22 X 50 mm	35.03
TOY-04456-20060-71	I-U-12	22 X 50 mm	20.10
TOY-04456-30010-71	P-U-1	25 X 55 mm	32.43
TOY-04456-30011-71	P-U-12	25 X 55 mm	42.36
TOY-04651-10060-71	P-N-4	50 X 80 mm	42.26
TOY-04651-10132-71	P-U-5	30 X 80 mm	56.51
TOY-04651-10330-71	P-U-5	30 X 70 mm	44.53
TOY-04651-10333-71	P-U-5	30 X 70 mm	65.72
TOY-04651-10334-71	P-U-5	30 X 70 mm	65.72
TOY-04651-10652-71	P-U-4	50 X 65 mm	67.45
TOY-04651-10662-71	P-U-4	50 X 65 mm	67.45
TOY-04651-10671-71	P-U-1	70 mm Rod Kit	57.12
TOY-04651-10870-71	P-U-1	70 X 80 mm	65.12
TOY-04651-10871-71	P-U-1	70 mm Rod Kit	57.12
TOY-04651-10882-71	P-U-5	30 X 70 mm	65.72
TOY-04651-10892-71	P-U-5	30 X 70 mm	65.72
TOY-04651-11032-71	P-U-1	35 X 50 mm	40.00
TOY-04651-11061-71	P-U-4	40 X 50 mm	46.94
TOY-04651-11250-71	P-U-1	75 X 90 mm	96.56
TOY-04651-11261-71	P-U-1	35 X 50 mm	39.78
TOY-04651-11270-71	P-U-1	75 X 90 mm	97.51
TOY-04651-11271-71	P-U-1	75 mm Rod Kit	61.27
TOY-04651-11290-71	P-U-4	40 X 50 mm	46.67
TOY-04651-11291-71	P-U-4	40 X 50 mm	46.38
TOY-04651-11300-71	N-U-4	50 X 65 mm	50.10
TOY-04651-11390-71	P-U-4	40 X 50 mm	50.24
TOY-04651-20132-71	P-U-1	60 X 70 mm	70.61
TOY-04651-20133-71	P-U-4	60 X 70 mm	78.39

TOYOTA LIFT TRUCKS

Kit Number	Code (Pg. x)	Rod X Bore Size	List Price
TOY-04651-20141-71	P-U-4	50 X 70 mm	\$ 57.67
TOY-04651-20142-71	P-U-4	50 X 70 mm	65.66
TOY-04651-20151-71	P-V-1	30 mm Rod Kit	73.98
TOY-04651-20182-71	P-U-4	60 X 75 mm	68.14
TOY-04651-20184-71	P-U-1	75 X 90 mm	70.13
TOY-04651-20185-71	P-U-1	75 X 90 mm	70.13
TOY-04651-20186-71	P-U-1	75 X 90 mm	97.51
TOY-04651-20260-71	P-U-1	50 X 70 mm	46.19
TOY-04651-20262-71	P-U-1	50 X 70 mm	58.36
TOY-04651-20262-71	P-U-1	50 X 70 mm	58.36
TOY-04651-20390-71	P-U-4	50 X 70 mm	69.44
TOY-04651-20400-71	P-U-4	60 X 70 mm	76.18
TOY-04651-20421-71	P-U-4	50 X 70 mm	66.41
TOY-04651-20441-71	P-U-5	30 X 70 mm	41.36
TOY-04651-20442-71	P-U-5	30 X 70 mm	65.72
TOY-04651-20841-71	P-U-1	75 X 90 mm	97.66
TOY-04651-20970-71	P-U-1	75 X 90 mm	97.51
TOY-04651-20971-71	P-U-1	75 mm Rod Kit	61.40
TOY-04651-20980-71	P-U-4	40 X 50 mm	38.19
TOY-04651-20992-71	P-U-1	35 X 50 mm	39.78
TOY-04651-21150-71	P-U-4	40 X 50 mm	38.48
TOY-04651-21151-71	P-U-4	40 X 50 mm	46.67
TOY-04651-21290-71	P-U-4	40 X 50 mm	38.48
TOY-04651-21310-71	P-U-1	35 X 50 mm	39.50
TOY-04651-21340-71	P-U-1	35 X 50 mm	39.78
TOY-04651-21350-71	P-U-4	40 X 50 mm	49.56
TOY-04651-30111-71	P-N-4	60 X 100 mm	53.61
TOY-04651-30170-71	P-U-5	40 X 100 mm	63.66
TOY-04651-30181-71	I-U-1	30 X 90 mm	60.57
TOY-04651-30211-71	P-N-4	60 X 80 mm	62.96
TOY-04651-30212-71	P-U-4	60 X 80 mm	65.72
TOY-04651-30292-71	I-U-4	80 X 104 mm	57.45
TOY-04651-30561-71	P-U-4	60 X 80 mm	71.58
TOY-04651-30841-71	P-U-1	90 X 105 mm	88.02
TOY-04651-30842-71	P-U-1	90 X 105 mm	119.00
TOY-04651-30911-71	P-U-1	60 X 80 mm	62.83
TOY-04651-30920-71	P-U-4	60 X 80 mm	72.82
TOY-04651-30980-71	P-U-4	60 X 80 mm	50.51
TOY-04651-30991-71	P-U-5	40 X 100 mm	46.43
TOY-04651-31170-71	P-U-1	55 X 65 mm	55.67
TOY-04651-31180-71	P-U-4	50 X 65 mm	64.42
TOY-04651-31181-71	P-U-4	50 X 65 mm	58.77
TOY-04651-31210-71	P-U-1	90 X 105 mm	119.95
TOY-04651-31211-71	P-U-1	85 X 105 mm	120.23
TOY-04651-31220-71	P-U-1	40 X 60 mm	38.27
TOY-04651-31230-71	P-U-1	40 X 60 mm	38.54
TOY-04651-31240-71	P-U-1	55 X 65 mm	56.57
TOY-04651-31250-71	P-U-1	55 X 65 mm	56.84
TOY-04651-31280-71	P-U-4	50 X 65 mm	63.44
TOY-04651-31281-71	P-U-4	50 X 65 mm	57.81

TOYOTA LIFT TRUCKS

Kit Number	Code (Pg. x)	Rod X Bore Size	List Price
TOY-04651-31282-71	P-U-4	50 X 65 mm	\$ 48.72
TOY-04651-31290-71	P-U-4	60 X 90 mm	71.44
TOY-04651-31302-71	P-U-1	95 mm Rod Kit	73.30
TOY-04651-31311-71	P-U-1	105 mm Rod Kit	74.12
TOY-04651-31410-71	P-U-1	45 X 65 mm	48.24
TOY-04651-31420-71	P-U-1	45 X 65 mm	49.21
TOY-04651-31430-71	P-U-1	55 X 65 mm	57.12
TOY-04651-31440-71	P-U-1	55 X 65 mm	54.98
TOY-04651-31450-71	P-U-4	70 X 90 mm	89.80
TOY-04651-31500-71	P-U-4	45 X 55 mm	49.62
TOY-04651-31510-71	P-U-4	45 X 55 mm	49.34
TOY-04651-31520-71	P-U-4	45 X 55 mm	50.31
TOY-04651-31530-71	P-U-4	45 X 55 mm	48.53
TOY-04651-31800-71	P-U-4	55 X 80 mm	58.12
TOY-04651-31810-71	P-U-4	55 X 80 mm	54.25
TOY-04651-31820-71	P-U-5	70 X 120 mm	143.18
TOY-04651-31830-71	P-U-5	70 X 110 mm	43.68
TOY-04652-10020-71	P-U-1	70 X 80 mm	91.67
TOY-04652-10030-71	P-U-1	70 X 80 mm	91.67
TOY-04652-10170-71	P-U-1	70 mm Rod Kit	44.92
TOY-04652-10191-71	P-U-1	70 X 85 mm	33.37
TOY-04652-10300-71	P-U-13	50 X 70 mm	59.37
TOY-04652-20031-71	P-U-1	75 X 90 mm	74.54
TOY-04652-20040-71	P-U-1	75 X 90 mm	69.59
TOY-04652-30010-71	P-U-1	90 X 105 mm	89.05
TOY-04652-30011-71	P-U-1	85 X 105 mm	87.26
TOY-04652-30020-71	P-U-1	40 X 60 mm	38.54
TOY-04652-30030-71	P-U-1	40 X 60 mm	38.27
TOY-04652-30040-71	P-U-1	50 X 70 mm	51.05
TOY-04652-30050-71	P-U-1	50 X 70 mm	52.04
TOY-04652-30131-71	P-U-1	85 X 105 mm	87.07
TOY-04652-30132-71	P-U-1	85 X 105 mm	50.49
TOY-04652-30150-71	P-U-1	85 X 105 mm	82.03
TOY-04652-U1020-71	I-U-4	2 X 2-3/4	61.37
TOY-04652-U2010-71	I-U-4	50 X 75 mm	73.19
TOY-04652-U2020-71	I-U-4	2" X 75 mm	64.16
TOY-04653-10020-71	P-U-4	35 X 45 mm	44.87
TOY-04653-10030-71	P-U-4	35 X 45 mm	44.38
TOY-04653-10040-71	P-U-4	35 X 45 mm	44.87
TOY-04653-10050-71	P-U-4	35 X 45 mm	44.59
TOY-04653-10060-71	P-U-1	35 X 50 mm	40.61
TOY-04653-10530-71	P-U-N	35 X 45 mm	17.19
TOY-04653-20071-71	P-U-4	40 X 50 mm	50.24
TOY-04653-20081-71	P-U-4	40 X 50 mm	50.57
TOY-04653-20090-71	P-U-1	35 X 50 mm	43.30
TOY-04653-20100-71	P-U-1	35 mm Rod Kit	37.64
TOY-04653-20110-71	P-U-1	35 X 50 mm	28.81
TOY-04653-20130-71	P-U-1	40 X 50 mm	38.73
TOY-04653-30010-71	P-U-1	55 X 65 mm	55.95
TOY-04653-30020-71	P-U-1	55 X 65 mm	55.95

TOYOTA LIFT TRUCKS

Kit Number	Code (Pg. x)	Rod X Bore Size	List Price
TOY-04653-30030-71	P-U-1	115 mm Rod Kit	\$105.11
TOY-04653-30050-71	P-U-5	45 X 55 mm	48.72
TOY-04653-30060-71	P-U-4	45 X 55 mm	50.03
TOY-04653-30111-71	P-U-1	90 mm	27.05
TOY-04653-30211-71	P-U-4	45 X 55 mm	48.31
TOY-04653-30221-71	P-U-4	45 X 55 mm	52.72
TOY-04653-30230-71	P-U-1	40 X 55 mm	48.53
TOY-04653-30240-71	P-U-1	40 X 55 mm	43.91
TOY-04653-30310-71	P-U-N	50 X 70 mm	25.72
TOY-04653-U1010-71	I-U-1	32 mm X 1-3/4 in	20.62
TOY-04653-U2010-71	I-U-4	1-3/8 X 2 in	34.63
TOY-04653-U3010-71	I-U-1	40 mm X 2-1/8 in	20.62
TOY-04654-10020-71	P-U-4	35 X 45 mm	44.94
TOY-04654-10030-71	P-U-4	35 X 45 mm	44.59
TOY-04654-20020-71	P-U-1	40 X 50 mm	38.73
TOY-04654-30020-71	P-U-4	45 X 55 mm	69.97
TOY-04654-30030-71	P-U-4	45 X 55 mm	68.54
TOY-04654-U1010-71	I-U-1	1-3/8 X 1-3/4 in	20.80
TOY-04654-U3010-71	I-U-4	45 X 55 mm	34.48
TOY-04655-20030-71	P-U-5	30 X 70 mm	58.98
TOY-04655-20080-71	P-U-5	30 X 70 mm	39.74
TOY-04655-20090-71	I-U-13	30 X 70 mm	125.56
TOY-04655-30040-71	P-U-5	40 X 90 mm	69.50
TOY-04655-30041-71	P-U-5	40 X 90 mm	75.22
TOY-04655-30300-71	P-U-5	45X100 mm	52.51
TOY-04655-U1010-71	P-U-13	30 X 70 mm	101.37
TOY-04655-U2010-71	I-U-10	1-1/4 X 2-3/4 in	54.05
TOY-04655-U3010-71	I-U-10	1-1/4 X 3 in	60.77
TOY-04671-20390-71	Valve Kit		34.77
TOY-04676-20560-71	Valve Kit		9.91
TOY-04676-20570-71	Valve Kit		19.36
TOY-04676-20722-71	Valve Kit		8.55
TOY-04676-20742-71	Valve Kit		10.68
TOY-04676-31161-71	Valve Kit		6.31
TOY-04676-31171-71	Valve Kit		8.55
TOY-04676-U2010-71	Valve Kit		16.68

TROJAN LOADER

Kit Number	Code (Pg. x)	Rod X Bore Size	List Price
TJN-2112888	P-U-10	2-3/4 X 6-1/4	\$ 48.30
TJN-2112889	P-U-10	4 X 9	110.03
TJN-2114241	P-U-10	3 X 7	55.58
TJN-3000SC	I-U-1	1-3/4 X 4	12.97
TJN-6755591	P-U-9	3 X 6-1/2	101.90

UP-RIGHT

Kit Number	Code (Pg. x)	Rod X Bore Size	List Price
UPRT-060211-014	I-U-4	1 X 2	\$ 12.60
UPRT-063905-010	I-U-11	1-1/4 X 2-1/2	15.37
UPRT-101015-010	I-U-10	1 X 2-1/4	9.49
UPRT-63904-010	I-U-4	2-1/2 X 5	56.78
UPRT-64346-010	I-U-11	1-1/4 X 3	14.29
UPRT-65397-011	I-U-11	3/4 X 2-1/4	10.48
UPRT-65970-011	I-U-10	3/4 X 1-1/4	13.50
UPRT-68457-010	I-U-11	3/4 X 2-1/4	10.50

VANGUARD

Kit Number	Code (Pg. x)	Rod X Bore Size	List Price
VG-101422	I-U-3	2-1/2 X 4	\$ 32.71
VG-10756	I-U-10	1-1/2 X 3-1/2	10.50
VG-10758	I-U-11,12		30.79
VG-10759	I-U-12	2 X 4	48.98
VG-17579	P-OB-3	1-1/4 X 3	9.11
VG-25068	I-U-10	2-1/2 X 4	13.84
VG-47105	I-U-10	1-1/4 X 3	25.43
VG-47107	I-U-10,12	2-1/2 X 4	52.96
VG-47152	I-U-12	1-3/8 X 3-1/4	51.00
VG-47763	I-U-10	1-1/4 X 3	18.54
VG-53957	I-U-10	1-1/2 X 3	22.26
VG-A13215651	I-U-5	2-1/2 X 4	26.21

VENCO LIFTGATES

Kit Number	Code (Pg. x)	Rod X Bore Size	List Price
VE-13088	P-U-4	1-1/4 X 4	\$ 53.80
VE-13089	P-U-4	1-1/4 X 3-1/2	45.11
VE-13090	P-U-4	1-1/8 X 3	38.96



NOTES

Kingseal Co., Ltd. Thailand

REPLACEMENT SEAL KITS FOR VOLVO EQUIPMENT*

VOLVO

Replacement Seal Kits By Machine Type

Table of Contents

Machine Type		Page
Articulated Dump Trucks	5350B, A20, A25, A25B, A25C, A30, A30C, A35, A35C	482
Excavators	EC230B, EC280, EC340, EC360	483
Log Skidders	662, 664, 664B, 664C, 664D, 666, 666B, 666C, 666D, 667C, 667D, 668, 668B, 668C, 668D, F65, F665, F666, F668	483 - 485
Motor Graders	710-740A, 750A & 780A	485
Wheel Dozers	180, 180-III, 280, 280B, 280C, 280-III, 280-IIIA, 380B, 380-III, 380-III A, W380	485 - 487
Wheel Loaders	12B, 35A, 35AWS, 35B, 35C, 35R, 45A, 45B, 45FB, 45C, 55A, 55A-II, 55-III, 55-III A, 55-III A GRR, 55B, 55C, 75A-II, 75B, LF75B, 75C, 75-III, 75-III A, 85A, 85A-II, 85A-II, 85-III, 85-III A, 125A, 125A-II, 125-111A, 125B, 125C, 175A, 175A-II, 175B, 175C, 175-III, 175-III A, 275B, 275C, 275-III, 275-III A, 475B, 475C, 475CT, 475-III A, 675B, L30, L50, L50B, L70, L70B, L90, L90B, L120, L120B, L140, L150, L160, L180, L190, L270, L270B, L320, L480, L480B, L480T	487 - 497
Alpha-Numeric Kit Listing		498 - 499



KINGSEAL CO., LTD. THAILAND

46/152-153 Moo 3 Sri Saman Road
Baan Mai Pakkret, Nonthaburi Thailand 11120

Tel: +662 9617534 to 6

Fax: +662 9617540

Email: intlsales@kingseal.co.th / kingsealmail@gmail.com

Website: <http://www.kingseal.co.th>

All manufacturer's names, part numbers and descriptions are used for reference purposes only. We do not imply that any part shown is the product of these manufacturers. We also do not imply that the list price shown is exactly that of the manufacturer.

Replacement Kits For

VOLVO**VOLVO**

Articulated Dump Trucks							
APPLICATION	CYL #	SERIAL #	CODE	ROD	BORE	KIT #	List \$
MODEL 5350B							
STEERING	4782849-6	-2475	P-U-15	70 mm	100 mm	VME-6630443	42.88
	4833274-6	2746-	P-U-15	70 mm	100 mm	VME-6630443	42.88
TILT	11053261-1		I-U-1	60,75,90,105,120,140 mm		VME-6630839	196.30
	11053262-9		I-U-1	75,90,105,120,140,160 mm		VME-6630852	221.62
	4941338-8		I-U-1	60,75,90,105,120,140 mm		VME-6630839	196.30
	4941761-1		P,I-U-1	70,105,120,140 mm		VME-6213407	233.82
	4942058-1		I-U-1	75,90,105,120,140,160 mm		VME-6630852	221.62
MODEL A20							
STEERING	4833274-6		P-U-15	70 mm	100 mm	VME-6630443	42.88
TILT	11053261-1	1533-	I-U-1	60,75,90,105,120,140 mm		VME-6630839	196.30
	11053262-9	1127-1532	I-U-1	75,90,105,120,140,160 mm		VME-6630852	221.62
	4942058-1	-1126	I-U-1	75,90,105,120,140,160 mm		VME-6630852	221.62
MODEL A25							
STEERING	4833274-6		P-U-15	70 mm	100 mm	VME-6630443	42.88
TILT	11043078-2	4067-5598	I-U-1	75,120,140 mm		VME-11991589	149.27
	11053261-1	4092-5486	I-U-1	60,75,90,105,120,140 mm		VME-6630839	196.30
	11053262-9	-5486	I-U-1	75,90,105,120,140,160 mm		VME-6630852	221.62
	11061382-5	5487-	I-U-1	75,95,105,120,140 mm		VME-11993411	232.61
	11061383-3	5599-	I-U-1	75,120,140 mm		VME-11993103	120.26
	4941338-8	-4091	I-U-1	60,75,90,105,120,140 mm		VME-6630839	196.30
	4941761-1	-4066	P,I-U-1	70,105,120,140 mm		VME-6213407	233.82
MODEL A25B							
STEERING	4833274-6		P-U-15	70 mm	100 mm	VME-6630443	42.88
MODEL A25C							
STEERING	4833274-6	-10256/-60911	P-U-15	70 mm	100 mm	VME-6630443-7	42.98
TIPPING (4X4)	11088346-9	-10256/-60911	P-U-13	70 mm	125 mm	VME-11990351-	142.84
TIPPING (6X6)	11005475-6	-10256/-60911	P-U-13	70 mm	125 mm	VME-11990351-	142.84
MODEL A30							
STEERING	11005212-3	-1183; -1186(USA)	P-U-15	60 mm	100 mm	VME-6630843	45.38
	11005212-3		P-U-15	60 mm	100 mm	VME-6630843-8	44.33
	11088154-7	1184; 1187(USA)-	P-U-15	60 mm	100 mm	VME-6630843	45.38
TIPPING	11005120-8		P-U-15	80mm	140 mm	VME-11990170-	142.78
	11088306-3		P-U-15	80mm	140 mm	VME-11990170-	142.78
MODEL A30C							
HOIST	11088306-3	-2320/ - 2275	P-U-15	80mm	140 mm	VME-11990170-	142.78
	11088815-3	-2320/-2275	P-U-15	80mm	140 mm	VME-11990170-	142.78
STEERING	11088154-7	-2320/-2275	P-U-15	60 mm	100 mm	VME-6630843-8	44.33
MODEL A35							
STEERING	11088155-4	1882; 1886(USA)-	P-U-15	70 mm	110 mm	VME-11990070	54.14
	4833125-0	-1881; -1885(USA)	P-U-15	70 mm	110 mm	VME-11990070	54.14
TILT	11043080-8	-1194; -1200(USA)	I-U-1	75,120,140 mm		VME-11991589	149.27
	11061384-1	1195; 1201(USA)-	I-U-1	75,120,140 mm		VME-11993103	120.26
MODEL A35C							
STEERING	11088751-0	-4260	P-U-15	70 mm	110 mm	VME-11701665-	39.41
TILT	11061384-1	-4260	I-U-1	75,120,140 mm		VME-11993103-	124.72

Replacement Kits For

VOLVO

VOLVO

Excavators							
APPLICATION	CYL #	SERIAL #	CODE	ROD	BORE	KIT #	List \$
MODEL EC230B							
BOOM/ FRONT SHOVEL	142508811	0-4655	P-UB-11	105 mm	160 mm	VME-11997089-5	443.88
	142654656	4656-UP	P-UB-11	105 mm	160 mm	VME-11997089-5	443.88
BOOM/ MATERIAL HANDLE	142479005	0-4655	P-UB-11	105 mm	160 mm	VME-11997089-5	443.88
	142654649	4656-UP	P-UB-11	105 mm	160 mm	VME-11997089-5	443.88
BUCKET	142508902	0-4655	P-UB-14	90 mm	140 mm	VME-11997091-1	353.49
	142654664	4656-UP	P-UB-14	90 mm	140 mm	VME-11997091-1	353.49
BUCKET/ ARTICULATESLOPE	142459759		P-U-14	50 mm	70 mm	VME-11997227	176.65
BUCKET/ QUICK FIT	142357003	0-4465	P-UB-10	32 mm	70 mm	VME-11999887	71.96
	142616416	4466-UP	P-UB-10	32 mm	70 mm	VME-11999887	71.96
DIPPER ARM	140533530		P-UB-14	105 mm	150 mm	VME-11997226	307.23
KNUCKLE	142654680	ALL	P-UB-11	105 mm	160 mm	VME-11997089-5	443.88
KNUCKLE/ FRONT SHOVEL	140533357		P-UB-15	80 mm	125 mm	VME-11997225	208.82
MODEL EC280							
ARM	143446169		P-UB-10	110 mm	160 mm	VME-11705818	325.33
BOOM	143446151		P-UB-10	100 mm	150 mm	VME-11703474	278.71
BUCKET	143446169		P-UB-10	110 mm	160 mm	VME-11705818	325.33
	143446177		P-UB-10	95 mm	140 mm	VME-11705814	249.39
QUICK FIT	143419398		P-UB-10	32 mm	70 mm	VME-11702311	56.07
MODEL EC340							
ARM	143423911		P-UB-10	125 mm	170 mm	VME-11702757	385.22
BOOM	143446185		P-UB-10	105 mm	150 mm	VME-11702744	257.52
BUCKET	143423911		P-UB-10	125 mm	170 mm	VME-11702757	385.22
BUCKET/ QUICK FIT	143419398		P-UB-10	32 mm	70 mm	VME-11702311	56.07
MODEL EC360							
BOOM	114604980	Standard seal kit	P-UB-14	105 mm	160 mm	VME-814816020	309.85
	114607440	Tropical seal kit	P-UB-14	105 mm	160 mm	VME-814816130	309.85
BUCKET		Tropical seal kit	P-UB-14	105 mm	150 mm	VME-814816150	257.00
	114605000	Standard seal kit	P-UB-14	105 mm	150 mm	VME-814816030	257.00
DIPPER ARM	114604990	Standard seal kit	P-UB-14	115 mm	170 mm	VME-814816040	362.33
	114607450	Tropical seal kit	P-UB-14	115 mm	170 mm	VME-814816140	362.33
Log Skidders							
APPLICATION	CYL #	SERIAL #	CODE	ROD	BORE	KIT #	List \$
MODEL 662							
STEER & BLADE	1904666	501A; 501B; 502A; 502B	P-U-10	1-3/4	3-1/2	VME-1991086	31.16
MODEL 664							
STEER & BLADE	1904674	C9014; C9024; C9034; C9044	P-U-10	1-3/4	3-1/2	VME-1991086	31.16
	1906258	C9014; C9024; C9034; C9044	P-U-10	1-3/4	3-1/2	VME-1991086	31.16
MODEL 664B							
ARCH	1906258	514E; 514F; 508A; 508B; 508C	P-U-10	1-3/4	3-1/2	VME-1991086	31.16
GRAPPLE	1916232	514E; 514F; 508A; 508B; 508C	P-TR-10	2-3/4	6	VME-1991089	69.53
STEER & BLADE	1906258	514E; 514F; 508A; 508B; 508C	P-U-10	1-3/4	3-1/2	VME-1991086	31.16
MODEL 664C							
ARCH	1904666	514H; 508H; 546H	P-U-10	1-3/4	3-1/2	VME-1991086	31.16
GRAPPLE	1916232	514H; 508H; 546H	P-TR-10	2-3/4	6	VME-1991089	69.53
STEER & BLADE	1904666	514H; 508H; 546H	P-U-10	1-3/4	3-1/2	VME-1991086	31.16

Replacement Kits For

VOLVO

VOLVO

Log Skidders							
APPLICATION	CYL #	SERIAL #	CODE	ROD	BORE	KIT #	List \$
MODEL 664D							
ARCH	2552115	528A-528D; 540A; 529C; 551D-551G	P-UB-10	2	4	VME-2551403	47.18
STEER & BLADE	2552115	528A-528D; 540A; 529C; 551D-551G	P-UB-10	2	4	VME-2551403	47.18
MODEL 666							
STEER & BLADE	1904674	C9016; C9026; C9036; C9046	P-U-10	1-3/4	3-1/2	VME-1991086	31.16
	1906258	C9016; C9026; C9036; C9046	P-U-10	1-3/4	3-1/2	VME-1991086	31.16
MODEL 666B							
ARCH	1906258	513E-513G; 515A; 500D-500G; 526A	P-U-10	1-3/4	3-1/2	VME-1991086	31.16
GRAPPLE	1916232	513E-513G; 515A; 500D-500G; 526A	P-TR-10	2-3/4	6	VME-1991089	69.53
STEER & BLADE	1904674	513E-513G; 515A; 500D-500G; 526A	P-U-10	1-3/4	3-1/2	VME-1991086	31.16
	1906258	513E-513G; 515A; 500D-500G; 526A	P-U-10	1-3/4	3-1/2	VME-1991086	31.16
MODEL 666C							
ARCH	1904666	513H; 500H; 515H; 542H; 526H	P-U-10	1-3/4	3-1/2	VME-1991086	31.16
GRAPPLE	1916232	513H; 500H; 515H; 542H; 526H	P-TR-10	2-3/4	6	VME-1991089	69.53
	2552121	513H; 500H; 515H; 542H; 526H	P-UB-10	2	4	VME-2551403	47.18
STEER & BLADE	1904666	513H; 500H; 515H; 542H; 526H	P-U-10	1-3/4	3-1/2	VME-1991086	31.16
	1904666	513H; 500H; 515H; 542H; 526H	P-U-10	1-3/4	3-1/2	VME-1991086	31.16
MODEL 666D							
ARCH	2552115	548A; 549A; 552A; 555A; 559A; 564B	P-UB-10	2	4	VME-2551403	47.18
BOOM	2552115	548A; 549A; 552A; 555A; 559A; 564B	P-UB-10	2	4	VME-2551403	47.18
GRAPPLE	2552115	548A; 549A; 552A; 555A; 559A; 564B	P-UB-10	2	4	VME-2551403	47.18
	2552121	548A; 549A; 552A; 555A; 559A; 564B	P-UB-10	2	4	VME-2551403	47.18
STEER & BLADE	2552361	548A; 549A; 552A; 555A; 559A; 564B	P-UB-10	1-3/4	3-1/2	VME-2542570	50.79
MODEL 667C							
ARCH	1917220	503B; 504B-C; 509B; 510B-C; 534B-C; 535A; 536B-C; 537A	P-U-10	1-3/4	3-1/2	VME-1991086	31.16
	2552115	503B; 504B-C; 509B; 510B-C; 534B-C; 535A; 536B-C; 537A	P-UB-10	2	4	VME-2551403	47.18
BOOM	1919023	503B; 504B-C; 509B; 510B-C; 534B-C; 535A; 536B-C; 537A	P-U-10	1-3/4	3-1/2	VME-1991086	31.16
GRAPPLE	1916232	503B; 504B-C; 509B; 510B-C; 534B-C; 535A; 536B-C; 537A	P-TR-10	2-3/4	6	VME-1991089	69.53
STEER & BLADE	1917220	503B; 504B-C; 509B; 510B-C; 534B-C; 535A; 536B-C; 537A	P-U-10	1-3/4	3-1/2	VME-1991086	31.16
MODEL 667D							
ARCH	2552115	534D; 534E; 535D-G; 536D-E; 537D-G; 556G; 557G	P-UB-10	2	4	VME-2551403	47.18
BOOM	1919023	534D; 534E; 535D-G; 536D-E; 537D-G; 556G; 557G	P-U-10	1-3/4	3-1/2	VME-1991086	31.16
	2552115	534D; 534E; 535D-G; 536D-E; 537D-G; 556G; 557G	P-UB-10	2	4	VME-2551403	47.18
STEER & BLADE	2552361	534D; 534E; 535D-G; 536D-E; 537D-G; 556G; 557G	P-UB-10	1-3/4	3-1/2	VME-2542570	50.79
MODEL 668							
TILT	2518802	505A; 507A	P-U-10	1-3/4	3-1/2	VME-2538177	39.52
MODEL 668B							
TILT	2518802	505B; 507B	P-U-10	1-3/4	3-1/2	VME-2538177	39.52
MODEL 668C							
STEER & BLADE	2537607	505C; 507C; 532A; 533A; 538C; 539C	P-U-10	2	4	VME-2530107	32.72
MODEL 668D							
STEER & BLADE	2552141	507D; 507E; 532D; 532E; 539D; 539E	P-UB-10	2	4	VME-2551403	47.18

Replacement Kits For

VOLVO

VOLVO

Log Skidders							
APPLICATION	CYL #	SERIAL #	CODE	ROD	BORE	KIT #	List \$
MODEL F65							
ARCH	2552115	553G; 553GC; 554G; 554GC	P-UB-10	2	4	VME-2551403	47.18
GRAPPLE	2552121	553G; 553GC; 554G; 554GC	P-UB-10	2	4	VME-2551403	47.18
STEER & BLADE	2552115	553G; 553GC; 554G; 554GC	P-UB-10	2	4	VME-2551403	47.18
MODEL F665							
ARCH	2552115	553G; 554G	P-UB-10	2	4	VME-2551403	47.18
GRAPPLE	2552121	553G; 554G	P-UB-10	2	4	VME-2551403	47.18
STEER & BLADE	2552115	553G; 554G	P-UB-10	2	4	VME-2551403	47.18
MODEL F666							
ARCH	2552115	559B; 555B; 564B	P-UB-10	2	4	VME-2551403	47.18
BOOM	2552115	559B; 555B; 564B	P-UB-10	2	4	VME-2551403	47.18
GRAPPLE	2552121	559B; 555B; 564B	P-UB-10	2	4	VME-2551403	47.18
STEER & BLADE	2552361	559B; 555B; 564B	P-UB-10	1-3/4	3-1/2	VME-2542570	50.79
MODEL F668							
STEER & BLADE	2552141	565A; 566A	P-UB-10	2	4	VME-2551403	47.18
Motor Graders							
APPLICATION	CYL #	SERIAL #	CODE	ROD	BORE	KIT #	List \$
MODEL 710-740A							
CIRCLE SHIFT	89013	24736 & UP; 24483; 24598; 24599; 24619; 24620	I-U-5	2	4	VME-12724303	55.78
MODEL 750A & 780A							
CIRCLE TURN	89011	24736 & UP; 24483; 24598; 24599; 24619; 24620	I-U-5	1-3/8	3	VME-12724304	54.91
Wheel Dozers							
APPLICATION	CYL #	SERIAL #	CODE	ROD	BORE	KIT #	List \$
MODEL 180							
PITCH	1503598	2892-2942; 2LC52-; 2LG101-	P-V-10	2-3/4	6	VME-2516065	53.61
TILT	1503598	1896; 1898-1902; 2823-2891; 1823-1895; 1897; 1903; 1904	P-V-10	2-3/4	6	VME-2516065	53.61
	1503986	2892-2942; 2LC52-; 2LG101-	P-V-10	1-3/4	3-1/2	VME-2516071	35.51
MODEL 180-III							
LIFT	1503608	5LC101-; 6LG101-; 4035B101FSC-	P-U-10	2	5	VME-2516059	47.04
PITCH	1503598	5LC101-; 6LG101-; 4035B101FSC-	P-V-10	2-3/4	6	VME-2516065	53.61
STEERING	1503987	5LC101-; 6LG101-; 4035B101FSC-	P-V-10	1-3/4	3-1/2	VME-2516071	35.51
TILT	1503986	5LC101-; 6LG101-; 4035B101FSC-	P-V-10	1-3/4	3-1/2	VME-2516071	35.51
MODEL 280							
LIFT	1503604	32123-32999; 1MC156-3MC999; 1MG1-3MG999	P-V-10	2-3/4	6	VME-2516065	53.61
PITCH	1503607	32123-32999; 1MC156-3MC999; 1MG1-3MG999	P-V-10	2-3/4	6	VME-2516065	53.61
MODEL 280B							
LIFT	2522607	498A; 499A	P-U-10	2-3/4	6	VME-2538182	56.49
	962698	498A; 499A	P-UB-10	2-3/4	6	VME-2542568	150.28
PITCH	964665	498A; 499A	P-UB-10	2	4-1/2	VME-2551398	49.54
STEERING	2528419	498A; 499A	P-U-10	2-1/4	5-1/4	VME-2538181	45.99
	964663	498A; 499A	P-UB-10	2-1/4	5-1/4	VME-2551399	71.79
TILT	2522880	498A; 499A	P-U-10	2-1/4	5-1/4	VME-2538181	45.99
	964662	498A; 499A	P-UB-10	2-1/4	5-1/4	VME-2551399	71.79
MODEL 280C							
LIFT	12565916	819A	P-U-10	2-3/4	6	VME-2538182	56.49

Replacement Kits For

VOLVO

VOLVO

Wheel Dozers							
APPLICATION	CYL #	SERIAL #	CODE	ROD	BORE	KIT #	List \$
MODEL 280C							
LIFT	2522607	819A	P-U-10	2-3/4	6	VME-2538182	56.49
	962698	819A	P-UB-10	2-3/4	6	VME-2542568	150.28
PITCH	964665	819A	P-UB-10	2	4-1/2	VME-2551398	49.54
STEERING	2528419	819A	P-U-10	2-1/4	5-1/4	VME-2538181	45.99
	964663	819A	P-UB-10	2-1/4	5-1/4	VME-2551399	71.79
TILT	2522880	819A	P-U-10	2-1/4	5-1/4	VME-2538181	45.99
	964662	819A	P-UB-10	2-1/4	5-1/4	VME-2551399	71.79
MODEL 280-III							
LIFT	1503604	4MC102-6MC999; 4MG101-8MG999	P-V-10	2-3/4	6	VME-2516065	53.61
PITCH	1503607	4MC102-6MC999; 4MG101-8MG999	P-V-10	2-3/4	6	VME-2516065	53.61
MODEL 280-III A							
LIFT	1503604	8AMC192-; 9AMG425-; 4047B101FSC-; 456B101-999; 456C101-145C-; 460D101C-130C	P-V-10	2-3/4	6	VME-2516065	53.61
	1503605	8AMC101-8AMC192; 9AMG125- 9AMG424	P-U-10	2-1/4	5-1/2	VME-2516094	46.04
PITCH	2522607	456C146C-; 460D131C-	P-U-10	2-3/4	6	VME-2538182	56.49
	964665	460D131C-	P-UB-10	2	4-1/2	VME-2551398	49.54
STEERING	1503241	8AMC101-8AMC217; 9AMG125- 9AMG469	P-U-10	2-1/4	5-1/2	VME-2516094	46.04
	1503606	456B101-999; 456C101-145C	P-U-10	2-1/4	5-1/2	VME-2516094	46.04
TILT	1515236	3AMC218-; 9AMG470-; 4047B101FSC-; 456B101-999; 456C101C-145C-; 460D101-130C	P-U-10	2-1/4	5-1/2	VME-2516094	46.04
	2522880	456C146C-	P-U-10	2-1/4	5-1/4	VME-2538181	45.99
STEERING	2522932	456C146C-; 460D131C-	P-U-10	2-1/4	5-1/4	VME-2538181	45.99
	964584	456C146C-	P-UB-10	2-1/4	5-1/4	VME-2551399	71.79
TILT	1503606	8AMC101-9AMC999; 9AMG122-; 9AMG124-; 4047B101FSC-; 460D101- 130C	P-U-10	2-1/4	5-1/2	VME-2516094	46.04
	2522880	460D131C-	P-U-10	2-1/4	5-1/4	VME-2538181	45.99
	964662	460D131C-	P-UB-10	2-1/4	5-1/4	VME-2551399	71.79
MODEL 380B							
LIFT	12568715	813A; 813B; 813BC	P-UB-10	2-3/4	6	VME-2542568	150.28
	12572636	813A; 813B; 813BC	P-UB-10	2-3/4	6	VME-2542568	150.28
	1510225	418F101K-114K; 484B101K-108K-; 434C101K-104K	P-V-10	2-3/4	6	VME-2516065	53.61
	2522115	418F115K-; 484B109K-; 434C105K-; 484C101C-136C	P-U-10	2-3/4	6	VME-2538182	56.49
	2522115	808A101C-110C; 810A101C-999C-; 434D101C-999C	P-U-10	2-3/4	6	VME-2538182	56.49
	2552344	418F; 484B; 434C; 813A; 813B; 813BC	P-U-10	2-3/4	6	VME-2538182	56.49
	2556914	813A; 813B; 813BC	P-UB-10	2-3/4	6	VME-2542568	150.28
	962697	484C101C-136C; 808A101C-110C-; 810A101C-999C; 434D101C-999C	P-UB-10	2-3/4	6	VME-2542568	150.28
	964787	484C137C-999C; 808A111C-999C-; 808A101CAC-; 484C101CAC-; 810A101CAC-	P-UB-10	2-3/4	6	VME-2542568	150.28
PITCH	1505457	418F101K-114K; 484B101K-108K-; 434C101K-104K	P-U-10	2-1/4	5-1/2	VME-2516094	46.04
	2522411	418F115K-; 484B109K-; 434C105K-; 484C; 808A; 434D; 810A; 813A; 813B-; 813BC	P-U-10	2-1/4	5-1/4	VME-2538181	45.99

VOLVO

Replacement Kits For



Wheel Dozers							
APPLICATION	CYL #	SERIAL #	CODE	ROD	BORE	KIT #	List \$
MODEL 380B							
PITCH	2556971	813A; 813B; 813BC	P-UB-10	2-1/4	5-1/4	VME-2551399	71.79
	964583	418F115K-; 484B109K-; 434C105K-; 484C; 808A; 434D; 810A; 813A; 813B; 813BC	P-UB-10	2-1/4	5-1/4	VME-2551399	71.79
STEERING	2522598	418F115K-; 484B109K-; 434C105K-; 484C; 808A; 434D; 810A; 813A; 813B; 813BC	P-UB-10	3-1/2	8	VME-2538186	118.11
TILT	2522120	418F115K-; 484B109K-; 434C105K-; 484C; 808A; 434D; 810A; 813A; 813B; 813BC	P-U-10	2-3/4	6	VME-2538182	56.49
	964577	418F115K-; 484B109K-; 434C105K-; 484C; 808A; 434D; 810A; 813A; 813B; 813BC	P-UB-10	2-3/4	6	VME-2542568	150.28
MODEL 380-III							
LIFT	1503610	5RG101-	P-U-10	2-3/4	7	VME-2516148	70.32
TILT	1503603	5RG101-	P-V-10	2-3/4	6	VME-2516065	53.61
MODEL 380-IIIA							
LIFT	1510225	418A406-; 418D; 484A; 434A	P-V-10	2-3/4	6	VME-2516065	53.61
	1531615	418A101-418A405; 434A	P-V-10	2-3/4	6	VME-2516065	53.61
PITCH	1505457	418A101-999; 418D; 484A; 434A	P-U-10	2-1/4	5-1/2	VME-2516094	46.04
MODEL W380							
TILT	2561629		P-UB-10	2-3/4	6	VME-2542568	150.28
Wheel Loaders							
APPLICATION	CYL #	SERIAL #	CODE	ROD	BORE	KIT #	List \$
MODEL 12B							
BUCKET	1503797		I-U-10	1-3/4	3-1/2	VME-2516072	26.48
MODEL 35A							
BOOM	1504471		P-V-10	2-3/4	6	VME-2516065	53.61
BUCKET	1504470		P-U-10	2	5	VME-2516059	47.04
CLAMP	2512955		P-V-10	1-3/4	3-1/2	VME-2516071	35.51
STEERING	1524562		I-U-10	1	2-1/2	VME-2516055	16.96
	1524563		I-U-10	1	2-1/2	VME-2516055	16.96
MODEL 35AWS							
BOOM	1504471	C5WG9-301-999; 7WG101-; C3WA9-91-999	P-V-10	2-3/4	6	VME-2516065	53.61
BUCKET	1504470	C5WG9-301-999; 7WG101-; C3WA9-91-999	P-U-10	2	5	VME-2516059	47.04
CLAMP	2512955		P-V-10	1-3/4	3-1/2	VME-2516071	35.51
STEERING	1524562	C5WG9-301-999; 7WG101-; C3WA9-91-999	I-U-10	1	2-1/2	VME-2516055	16.96
	1524563	C5WG9-301-999; 7WG101-; C3WA9-91-999	I-U-10	1	2-1/2	VME-2516055	16.96
MODEL 35B							
CLAMP			P-V-10	1-3/4	3-1/2	VME-2516071	35.51
STEERING	1524562		I-U-10	1	2-1/2	VME-2516055	16.96
	1524563		I-U-10	1	2-1/2	VME-2516055	16.96
MODEL 35C							
BOOM	2521773	458A101CB-116CB; 472A101CB-255CB	P-U-10	2	4	VME-2530107	32.72
	2521774	458A101CB-116CB; 472A101CB-255CB	P-U-10	2	4	VME-2530107	32.72
	2523265	458A117CB-; 472A256CB-	P-U-10	2	4	VME-2530107	32.72

Replacement Kits For

VOLVO**VOLVO**

Wheel Loaders							
APPLICATION	CYL #	SERIAL #	CODE	ROD	BORE	KIT #	List \$
MODEL 35C							
BOOM	2523266	458A101CB-116CB; 472A101CB-255CB	P-U-10	2	4	VME-2530107	32.72
	2530960	472D9101-; 807B9101-	P-UB-10	2	4-1/2	VME-2551398	49.54
	2530961	472D9101-; 807B9101-	P-UB-10	2	4-1/2	VME-2551398	49.54
	2533144	472D101CB-; 807B101CB-	P-UB-10	2	4	VME-2551403	47.18
	2533145	472D101CB-; 807B101CB-	P-UB-10	2	4	VME-2551403	47.18
	2538680	472C220CB-	P-U-10	2	4	VME-2530107	32.72
	2538682	472C220CB-	P-U-10	2	4	VME-2530107	32.72
	2538691	472C9101-; 807A9101-	P-U-10	2	4-1/2	VME-2538178	34.23
	2538692	472C9101-; 807A9101-	P-U-10	2	4-1/2	VME-2538178	34.23
BUCKET	2521041	458A101CB-116CB; 472A101CB-255CB	P-U-10	1-3/4	3-1/2	VME-2538174	26.54
	2521043	458A101CB-116CB; 472A101CB-255CB	P-U-10	1-3/4	3-1/2	VME-2538174	26.54
	2523229	458A117CB-; 472A256CB-327CB	P-U-10	1-3/4	3-1/2	VME-2538174	26.54
	2523230	458A117CB-; 472A256CB-327CB	P-U-10	1-3/4	3-1/2	VME-2538174	26.54
	2526749	472A328CB-	P-U-10	1-3/4	3-1/2	VME-2538174	26.54
	2526750	472A328CB-	P-U-10	1-3/4	3-1/2	VME-2538174	26.54
	2533903	472D9101CB-; 807B9101CB-	P-UB-10	1-3/4	3-1/2	VME-2542570	50.79
	2533904	472D101CB-; 807B101CB-	P-UB-10	1-3/4	3-1/2	VME-2542570	50.79
	2533905	472D101CB-; 807B101CB-	P-UB-10	1-3/4	3-1/2	VME-2542570	50.79
	2533906	472D101CB-; 807B101CB-	P-UB-10	1-3/4	3-1/2	VME-2542570	50.79
	2538686	472C220CB-	P-U-10	1-3/4	3-1/2	VME-2538174	26.54
	2538687	472C220CB-	P-U-10	1-3/4	3-1/2	VME-2538174	26.54
	2538696	807A9101-	P-U-10	1-3/4	3-1/2	VME-2538174	26.54
	2538697	472C9101-	P-U-10	1-3/4	3-1/2	VME-2538174	26.54
MODEL 35R							
BOOM			P-V-10	2-3/4	6	VME-2516065	53.61
BUCKET			P-U-10	2	5	VME-2516059	47.04
CLAMP			P-V-10	1-3/4	3-1/2	VME-2516071	35.51
STEERING			I-U-10	1	2-1/2	VME-2516055	16.96
MODEL 45A							
BOOM	1504472		P-U-10	2-3/4	7	VME-2516148	70.32
BUCKET	1504470		P-U-10	2	5	VME-2516059	47.04
STEERING	1524562		I-U-10	1	2-1/2	VME-2516055	16.96
	1524563		I-U-10	1	2-1/2	VME-2516055	16.96
MODEL 45B, 45FB							
BOOM	3980095		P-V-10	2	4-1/2	VME-2516271	36.91
BUCKET	3980108		P-U-10	1-3/4	3-1/2	VME-2516270	35.77
	3980125		P-U-10	1-3/4	3-1/2	VME-2516270	35.77
CLAMP	1539308		P-V-10	1-3/4	3-1/2	VME-2516071	35.51
GRAPPLE	1539308		P-V-10	1-3/4	3-1/2	VME-2516071	35.51
STEERING	3980906		I-U-10	1-1/4	2-1/2	VME-2516272	17.92
MODEL 45C							
BOOM	2521767	459A101CB-140CB; 473A101CB-322CB	P-U-10	2	4-1/2	VME-2538178	34.23
	2521768	459A101CB-140CB; 473A101CB-322CB	P-U-10	2	4-1/2	VME-2538178	34.23
	2522734	459A141CB-; 473A323CB-	P-U-10	2	4-1/2	VME-2538178	34.23

VOLVO

Replacement Kits For



Wheel Loaders							
APPLICATION	CYL #	SERIAL #	CODE	ROD	BORE	KIT #	List \$
MODEL 45C							
BOOM	2522735	459A141CB-; 473A323CB-	P-U-10	2	4-1/2	VME-2538178	34.23
	2530960	459E101CB-; 473D101CB-; 485B101CB-	P-UB-10	2	4-1/2	VME-2551398	49.54
BUCKET	2530961	459E101CB-; 473D101CB-; 485B101CB-	P-UB-10	2	4-1/2	VME-2551398	49.54
	2531210	459C9501-; 473C9501-; 485A9501-; 459E9101CB-; 473D9101CB-; 485B9101CB-	P-UB-10	2-1/4	5	VME-2542577	63.99
	2531211	459C9501-; 473C9501-; 485A9501-; 459E9101CB-; 473D9101CB-; 485B9101CB-	P-UB-10	2-1/4	5	VME-2542577	63.99
	2538691	459A141CB-; 473A323CB-	P-U-10	2	4-1/2	VME-2538178	34.23
	2538692	459D123CB-; 473C	P-U-10	2	4-1/2	VME-2538178	34.23
			P-UB-10	2	3-1/2	VME-2538184	49.25
	2521042	459A101CB-140CB; 473A101CB- 322CB	P-U-10	1-3/4	3-1/2	VME-2538174	26.54
	2521044	459A101CB-140CB; 473A101CB- 322CB	P-U-10	1-3/4	3-1/2	VME-2538174	26.54
	2522923	459A141CB-155CB; 473A323CB- 403CB	P-U-10	1-3/4	3-1/2	VME-2538174	26.54
	2522924	459A141CB-155CB; 473A323CB- 403CB	P-U-10	1-3/4	3-1/2	VME-2538174	26.54
	2526536	459A156CB-; 473A404CB-	P-U-10	1-3/4	3-1/2	VME-2538174	26.54
	2526537	459A156CB-; 473A404CB-	P-U-10	1-3/4	3-1/2	VME-2538174	26.54
	2531024	459C9501CB-; 473C9501-; 485A9501-	P-UB-10	2	4	VME-2551403	47.18
	2531025	459C9501CB-; 473C9501-; 485A9501-	P-UB-10	2	4	VME-2551403	47.18
	2533903	459E101CB-; 473D101CB-; 485B101CB-	P-UB-10	1-3/4	3-1/2	VME-2542570	50.79
	2533905	459E101CB-; 473D101CB-; 485B101CB-	P-UB-10	1-3/4	3-1/2	VME-2542570	50.79
	2538696	459D123CB-; 473C	P-U-10	1-3/4	3-1/2	VME-2538174	26.54
	2538697	459D123CB-; 473C	P-U-10	1-3/4	3-1/2	VME-2538174	26.54
MODEL 55A, 55A-II, 55-III, 55-IIIA, 55-IIIA GRR							
BOOM			P-V-10	1-3/4	3-1/2	VME-2516071	35.51
			P-U-10	2-1/4	5	VME-2530108	39.04
			P-UB-10	2-1/4	5	VME-2542577	63.99
	1507822	416A101-416A499; 4160A101FSC- 4160A499FSC	I-U-10	2-1/4	5	VME-2516060	32.01
	1507823	416A101-416A499; 4160A101FSC- 4160A499FSC	I-U-10	2-1/4	5	VME-2516060	32.01
	1508377	9BG101-; 9BA101-	P-U-10	2	3-1/2	VME-2516073	32.73
	1546056	433A101-; 416A500-; 4160A500FSC-; 4152A102FSC-	I-U-10	2-1/4	5	VME-2516060	32.01
	1546057	433A101-; 416A500-; 4160A500FSC-; 4152A102FSC-	I-U-10	2-1/4	5	VME-2516060	32.01
	2514111	433B700CAC-; 433B395FSC-; 416C857CAC-; 416C205FSC-	P-U-10	2-1/4	5	VME-2516058	38.11
	2514122	433B700CAC-; 433B395FSC-; 416C857CAC-; 416C205FSC-	P-U-10	2-1/4	5	VME-2516058	38.11
BUCKET			P-U-10	2	4	VME-2530107	32.72
			P-UB-10	2	4	VME-2551403	47.18
	1507711	9BG101-; 9BA101-	P-U-10	2	3-1/2	VME-2516073	32.73
	1539308		P-V-10	1-3/4	3-1/2	VME-2516071	35.51

Replacement Kits For

VOLVO

Wheel Loaders

APPLICATION	CYL #	SERIAL #	CODE	ROD	BORE	KIT #	List \$	
MODEL 55A, 55A-II, 55-III, 55-IIIA, 55-IIIA GRR								
BUCKET	1545412	433A101-433A110; 416A101-416A519; 4160A500FSC-; 4152A102FSC-	P-U-10	2	4	VME-2516090	31.23	
	1549758	433A111-; 416A520-	P-U-10	2	4	VME-2516090	31.23	
CLAMP	1539308		P-V-10	1-3/4	3-1/2	VME-2516071	35.51	
SIDE DUMP	1545577		P-U-10	2	3-1/2	VME-2516073	32.73	
STEERING			P-U-10	1-3/4	3-1/2	VME-2538177	39.52	
			P-UB-10	1-3/4	3-1/2	VME-2542570	50.79	
	1503828	9BG101-; 9BA101-	I-U-10	1	2-1/2	VME-2516055	16.96	
	1508904	416C101FSC-273; 4152101ENC-; 4152C101FSC-	I-U-10	1-3/4	3-1/2	VME-2516072	26.48	
	1508904	433B101C-; 433B101ENC-; 433B101FSC-631FSC; 416C101C-	I-U-10	1-3/4	3-1/2	VME-2516072	26.48	
MODEL 55B								
BOOM			I-U-10	2-1/4	5	VME-2516060	32.01	
			P-U-10	2-1/4	5	VME-2530108	39.04	
			P-UB-10	2-1/4	5	VME-2542577	63.99	
			P-V-10	1-3/4	3-1/2	VME-2516071	35.51	
			P-U-10	2	3-1/2	VME-2516073	32.73	
	2514111		P-U-10	2-1/4	5	VME-2516058	38.11	
BUCKET	2514122		P-U-10	2-1/4	5	VME-2516058	38.11	
			P-U-10	2	3-1/2	VME-2516073	32.73	
			P-UB-10	2	4	VME-2551403	47.18	
			P-V-10	1-3/4	3-1/2	VME-2516071	35.51	
			P-U-10	2	4	VME-2516090	31.23	
	2532635		P-U-10	2	4	VME-2530107	32.72	
CLAMP	1539306		P-V-10	1-3/4	3-1/2	VME-2516071	35.51	
SIDE DUMP	1545577		P-U-10	2	3-1/2	VME-2516073	32.73	
STEERING			I-U-10	1	2-1/2	VME-2516055	16.96	
			I-U-10	1-3/4	3-1/2	VME-2516072	26.48	
			P-UB-10	1-3/4	3-1/2	VME-2542570	50.79	
	2532705		P-U-10	1-3/4	3-1/2	VME-2538177	39.52	
MODEL 55C								
BOOM	2523872	480A; 480B101CB-152CB; 481A; 481B101CB-136CB	P-U-10	2-1/4	5	VME-2530108	39.04	
	2523873	480A; 480B101CB-152CB; 481A; 481B101CB-136CB	P-U-10	2-1/4	5	VME-2530108	39.04	
	2531210		P-UB-10	2-1/4	5	VME-2542577	63.99	
	2531211		P-UB-10	2-1/4	5	VME-2542577	63.99	
	2538706	480B153CB-; 481B137CB-	P-U-10	2-1/4	5	VME-2530108	39.04	
	2538707	480B153CB-; 481B137CB-	P-U-10	2-1/4	5	VME-2530108	39.04	
	BUCKET	2526667		P-U-10	2	4	VME-2530107	32.72
		2526668		P-U-10	2	4	VME-2530107	32.72
		2531024		P-UB-10	2	4	VME-2551403	47.18
		2531025		P-UB-10	2	4	VME-2551403	47.18
		2538701		P-U-10	2	4	VME-2530107	32.72
2538702			P-U-10	2	4	VME-2530107	32.72	
MODEL 75A-II								
BOOM			P-U-10	2	5	VME-2516059	47.04	
			P-V-10	2-1/4	4-1/2	VME-2516070	44.77	

Replacement Kits For

VOLVO

VOLVO

Wheel Loaders									
APPLICATION	CYL #	SERIAL #	CODE	ROD	BORE	KIT #	List \$		
MODEL 75A-II									
BOOM			P-U-10	2-1/4	5	VME-2516061	45.22		
BUCKET			P-U-10	2	5	VME-2516059	47.04		
			P-V-10	2-1/4	4-1/2	VME-2516070	44.77		
			P-U-10	2	4	VME-2516088	46.99		
CLAMP			P-V-10	1-3/4	3-1/2	VME-2516071	35.51		
SIDE DUMP			P-V-10	1-3/4	3-1/2	VME-2516071	35.51		
STEERING			P-V-10	1-3/4	3-1/2	VME-2516071	35.51		
	1503828		I-U-10	1	2-1/2	VME-2516055	16.96		
MODEL 75B, LF75B									
BOOM	1518977		P-U-10	2-1/4	5	VME-2530108	39.04		
	1518977		P-U-10	2-1/4	5	VME-2516058	38.11		
	1518978		P-U-10	2-1/4	5	VME-2516058	38.11		
	1518978		P-U-10	2-1/4	5	VME-2530108	39.04		
	1546056		I-U-10	2-1/4	5	VME-2516060	32.01		
	1546057		I-U-10	2-1/4	5	VME-2516060	32.01		
	2514111		P-U-10	2-1/4	5	VME-2516058	38.11		
	2514122		P-U-10	2-1/4	5	VME-2516058	38.11		
	2518075		P-U-10	2-1/4	5	VME-2516058	38.11		
	2518075		P-U-10	2-1/4	5	VME-2530108	39.04		
	2518076		P-U-10	2-1/4	5	VME-2530108	39.04		
	2518076		P-U-10	2-1/4	5	VME-2516058	38.11		
	2527513		P-U-10	2-1/4	5	VME-2530108	39.04		
	2527549		P-U-10	2-1/4	5	VME-2530108	39.04		
	2528565		P-U-10	2-1/4	5	VME-2530108	39.04		
	2528566		P-U-10	2-1/4	5	VME-2530108	39.04		
	2541827		P-UB-10	2-1/4	5	VME-2542577	63.99		
	2541828		P-UB-10	2-1/4	5	VME-2542577	63.99		
	BUCKET			P-U-10	2-1/4	5	VME-2530108	39.04	
		1511554		P-V-10	2-1/4	4-1/4	VME-2516054	33.51	
		2518071		P-V-10	2-1/4	4-1/4	VME-2516054	33.51	
		2520412		P-U-10	2-1/4	5	VME-2516058	38.11	
		2532204		P-U-10	2-1/4	5	VME-2516058	38.11	
		964581		P-UB-10	2-1/4	5	VME-2542577	63.99	
		CLAMP	1539308		P-V-10	1-3/4	3-1/2	VME-2516071	35.51
			1545577		P-U-10	2	3-1/2	VME-2516073	32.73
		SIDE DUMP			P-U-10	1-3/4	3-1/2	VME-2538177	39.52
1508904				I-U-10	1-3/4	3-1/2	VME-2516072	26.48	
2532706			P-UB-10	1-3/4	3-1/2	VME-2542570	50.79		
MODEL 75C									
BOOM			P-U-10	2-1/4	5	VME-2530108	39.04		
	2541827		P-UB-10	2-1/4	5	VME-2542577	63.99		
	2541828		P-UB-10	2-1/4	5	VME-2542577	63.99		
BUCKET			P-U-10	2-1/4	5	VME-2530108	39.04		
			P-U-10	2-3/4	5	VME-2538187	38.65		
			P-U-10	2-1/4	5	VME-2516058	38.11		
	2532204		P-UB-10	2-1/4	5	VME-2542577	63.99		
	2541652		P-UB-10	2-3/4	5	VME-2542569	56.56		
	964581		P-UB-10	2-1/4	5	VME-2542577	63.99		

Replacement Kits For

VOLVO

Wheel Loaders							
APPLICATION	CYL #	SERIAL #	CODE	ROD	BORE	KIT #	List \$
MODEL 75C							
STEERING			P-U-10	1-3/4	3-1/2	VME-2538177	39.52
	2529205		P-UB-10	1-3/4	3-1/2	VME-2542570	50.79
	2532705		P-UB-10	1-3/4	3-1/2	VME-2542570	50.79
	2541853		P-UB-10	1-3/4	3-1/2	VME-2542570	50.79
	964667		P-UB-10	1-3/4	3-1/2	VME-2542570	50.79
	964792		P-UB-10	1-3/4	3-1/2	VME-2542570	50.79
MODEL 75-III							
BOOM	1503887	10CG101-	P-V-10	2-1/4	4-1/2	VME-2516070	44.77
BUCKET	1503233	10CG101-	P-U-10	2	4	VME-2516088	46.99
	1507808	10CG101-	P-U-10	2	4	VME-2516088	46.99
STEERING	1503828	10CG101-	I-U-10	1	2-1/2	VME-2516055	16.96
MODEL 75-III A							
BOOM			P-U-10	2	5	VME-2516059	47.04
	1535946		P-U-10	2-1/4	5	VME-2516061	45.22
BUCKET			P-U-10	2	5	VME-2516059	47.04
	1509802		P-V-10	2-1/4	4-1/2	VME-2516070	44.77
	1536064		P-V-10	2-1/4	4-1/2	VME-2516070	44.77
CLAMP	1539308		P-V-10	1-3/4	3-1/2	VME-2516071	35.51
SIDE DUMP			P-V-10	1-3/4	3-1/2	VME-2516071	35.51
STEERING	1504836		P-V-10	1-3/4	3-1/2	VME-2516071	35.51
MODEL 85A, 85A-II							
STEERING	1503828		I-U-10	1	2-1/2	VME-2516055	16.96
	1503875		I-U-10	1	2-1/2	VME-2516055	16.96
MODEL 85A-II, 85-III, 85-III A							
BOOM			P-U-10	2	5	VME-2516059	47.04
	1502853		P-V-10	2-3/4	6	VME-2516065	53.61
	1502854		P-V-10	2-3/4	6	VME-2516065	53.61
	1503887		P-V-10	2-1/4	4-1/2	VME-2516070	44.77
BUCKET			P-V-10	2-3/4	6	VME-2516065	53.61
	1507808		P-U-10	2	4	VME-2516088	46.99
	1509813		P-V-10	2-1/4	4-1/2	VME-2516070	44.77
CLAMP			P-V-10	2-1/4	4-1/2	VME-2516070	44.77
SIDE DUMP			P-U-10	2	5	VME-2516059	47.04
STEERING	1503875		I-U-10	1	2-1/2	VME-2516055	16.96
	1531950		P-V-10	1-3/4	3-1/2	VME-2516071	35.51
MODEL 125A, 125A-II, 125-111A							
BOOM	1503235	12AFC101-; 12AFG101-	P-V-10	2-3/4	6	VME-2516065	53.61
	1503236		P-U-10	2-3/4	7	VME-2516148	70.32
BUCKET			P-U-10	2-3/4	7	VME-2516148	70.32
	1503234	404A101-404A299; 403A101-403A299	P-V-10	2-3/4	6	VME-2516065	53.61
	1509846	12AFC101-; 12AFG101-	P-V-10	2-1/4	4-1/2	VME-2516070	44.77
	1543216	404A300-; 403A300-	P-V-10	2-3/4	6	VME-2516065	53.61
STEERING			P-V-10	1-3/4	3-1/2	VME-2516071	35.51
MODEL 125B							
BOOM			P-UB-10	2-3/4	6	VME-2542568	150.28
			P-U-10	2-3/4	6	VME-2538182	56.49
	1519174		P-V-10	2-3/4	6	VME-2518493	64.18
	1519175		P-V-10	2-3/4	6	VME-2518493	64.18

Replacement Kits For

VOLVO

VOLVO

Wheel Loaders								
APPLICATION	CYL #	SERIAL #	CODE	ROD	BORE	KIT #	List \$	
MODEL 125B								
BOOM	2517389		P-V-10	2-3/4	6	VME-2518493	64.18	
	2517390		P-V-10	2-3/4	6	VME-2518493	64.18	
BUCKET			P-U-10	2-3/4	5	VME-2538187	38.65	
			P-UB-10	2-3/4	5	VME-2542569	56.56	
			P-U-10	2-1/4	4-1/2	VME-2538179	36.63	
			P-UB-10	2-1/4	4-1/2	VME-2542576	53.34	
STEERING	1519173		P-V-10	2-1/4	4-1/2	VME-2516152	40.49	
	2517395		P-V-10	2-1/4	4-1/2	VME-2516152	40.49	
			P-U-10	1-3/4	3-1/2	VME-2538177	39.52	
			P-UB-10	1-3/4	3-1/2	VME-2542570	50.79	
	2501171		I-U-10	1-3/4	3-1/2	VME-2516072	26.48	
MODEL 125C								
BOOM	2528568		P-U-10	2-3/4	6	VME-2538182	56.49	
	2528570		P-U-10	2-3/4	6	VME-2538182	56.49	
	2528982		P-U-10	2-3/4	6	VME-2538182	56.49	
	2528983		P-U-10	2-3/4	6	VME-2538182	56.49	
	2541356	496A170CB-; 497A171CB-; 4244A157FSC-	P-UB-10	2-3/4	6	VME-2542568	150.28	
	2541357	496A170CB-; 497A171CB-; 4244A157FSC-	P-UB-10	2-3/4	6	VME-2542568	150.28	
	2554419		P-UB-10	2-3/4	6	VME-2542568	150.28	
	2561089		P-UB-10	2-3/4	6	VME-2542568	150.28	
	964597	496A101CB-130CB; 497A101CB- 146CB	P-UB-10	2-3/4	6	VME-2542568	150.28	
	964598	496A101CB-130CB; 497A101CB- 146CB	P-UB-10	2-3/4	6	VME-2542568	150.28	
	964793	496A131CB-169CB; 497A147CB- 170CB; 4244101FSC-156FSC	P-UB-10	2-3/4	6	VME-2542568	150.28	
	964794	496A131CB-169CB; 497A147CB- 170CB; 4244101FSC-156FSC	P-UB-10	2-3/4	6	VME-2542568	150.28	
	BUCKET	2532213		P-U-10	2-3/4	5	VME-2538187	38.65
2541648		496A170CB-; 497A191CB-; 4244A169FSC-	P-UB-10	2-3/4	5	VME-2542569	56.56	
2554081			P-UB-10	2-3/4	5	VME-2542569	56.56	
2561088			P-UB-10	2-3/4	5	VME-2542569	56.56	
964796		496A101CB-169CB; 497A101CB- 190CB; 4244A101FSC-169FSC	P-UB-10	2-3/4	5	VME-2542569	56.56	
STEERING		2525743		P-U-10	1-3/4	3-1/2	VME-2538174	26.54
		2541852	496A170CB-; 497A191CB-; 4244A160FSC-	P-UB-10	1-3/4	3-1/2	VME-2542570	50.79
		964797	496A101CB-169CB; 497A101CB- 190CB; 4244A101FSC-159FSC	P-UB-10	1-3/4	3-1/2	VME-2542570	50.79
MODEL 175A								
STEERING	1503987		P-V-10	1-3/4	3-1/2	VME-2516071	35.51	
MODEL 175A-II								
STEERING	1503987		P-V-10	1-3/4	3-1/2	VME-2516071	35.51	
MODEL 175B								
BOOM			P-V-10	2-3/4	7	VME-2516155	101.30	
	1518400		P-V-10	2-3/4	7	VME-2518494	95.46	
	2518119		P-V-10	2-3/4	7	VME-2518494	95.46	
	2528567		P-UB-10	2-3/4	7	VME-2551397	104.63	

Replacement Kits For

VOLVO

VOLVO

Wheel Loaders							
APPLICATION	CYL #	SERIAL #	CODE	ROD	BORE	KIT #	List \$
MODEL 175B							
BOOM	964596		P-U-10	2-3/4	7	VME-2538183	59.56
BUCKET			P-V-10	2-3/4	6	VME-2516065	53.61
	1511622		P-V-10	2-3/4	6	VME-2518493	64.18
	1517851		P-V-10	2-3/4	6	VME-2518493	64.18
	2518125		P-V-10	2-3/4	6	VME-2518493	64.18
	2524276		P-U-10	2-3/4	6	VME-2538182	56.49
STEERING	964798		P-UB-10	2-3/4	6	VME-2542568	150.28
	1511641		P-V-10	2	4-1/2	VME-2516151	30.81
	2518117		P-V-10	2	4-1/2	VME-2516151	30.81
	2532353		P-U-10	2	4-1/2	VME-2538178	34.23
	964586		P-UB-10	2	4-1/2	VME-2551398	49.54
MODEL 175C							
BOOM	2524467		P-U-10	3	7	VME-2541637	72.14
	2541825		P-UB-10	3	7	VME-2542571	128.15
	964789		P-UB-10	3	7	VME-2542571	128.15
BUCKET	2524276		P-U-10	2-3/4	6	VME-2538182	56.49
	2541789		P-UB-10	2-3/4	6	VME-2542568	150.28
STEERING	964796		P-UB-10	2-3/4	6	VME-2542568	150.28
	2528848		P-U-10	2-1/4	4-1/2	VME-2538179	36.63
	2541510		P-UB-10	2-1/4	4-1/2	VME-2542576	53.34
	964801		P-UB-10	2-1/4	4-1/2	VME-2542576	53.34
MODEL 175-III, 175-III A							
BOOM	1503236		P-U-10	2-3/4	7	VME-2516148	70.32
BUCKET	1503234		P-V-10	2-3/4	6	VME-2516065	53.61
	1543216		P-V-10	2-3/4	6	VME-2516065	53.61
MODEL 275B							
BOOM			P-UB-10	3-1/2	9	VME-2551396	171.74
			P-U-10	3-1/2	9	VME-2538180	117.40
	1511407		P-V-10	3-1/2	9	VME-2516242	102.63
	1511408		P-V-10	3-1/2	9	VME-2516242	102.63
	1518399		P-V-10	3-1/2	9	VME-2516242	102.63
	1537215		I-U-10	3-1/2	9	VME-2516228	89.86
	1537216		I-U-10	3-1/2	9	VME-2516228	89.86
	2504218		P-V-10	3-1/2	9	VME-2516242	102.63
BUCKET			P-UB-10	2-3/4	7	VME-2551397	104.63
			P-U-10	2-3/4	7	VME-2538183	59.56
	1511406		P-V-10	2-3/4	7	VME-2516155	101.30
	1513815		P-V-10	2-3/4	7	VME-2518494	95.46
	2516176		P-V-10	2-3/4	7	VME-2518494	95.46
STEERING	947456		P-V-10	2-3/4	7	VME-2516155	101.30
			P-UB-10	2-1/4	5-1/4	VME-2551399	71.79
			P-U-10	2-1/4	5-1/4	VME-2538181	45.99
	1511749		P-V-10	2-1/4	5-1/4	VME-2516274	37.97
	1538181		I-U-10	2-1/4	5-1/4	VME-2516156	36.46
	2516160		P-V-10	2-1/4	5-1/4	VME-2516274	37.97
MODEL 275C							
BOOM	2525863		P-U-10	4	9	VME-2538193	125.02
	2541292	492A239C; 243C-999C; 492A201CAC-	P-UB-10	4	9	VME-2542574	232.61

Replacement Kits For

VOLVO

VOLVO

Wheel Loaders							
APPLICATION	CYL #	SERIAL #	CODE	ROD	BORE	KIT #	List \$
MODEL 275C							
BOOM	2554810		P-UB-10	4	9	VME-2542574	232.61
	964802	492A101C-238C; 240C; 241C; 242C	P-UB-10	4	9	VME-2542574	232.61
BUCKET	2541297	492A226C-235C	P-UB-10	2-3/4	7	VME-2551397	104.63
	964803	492A101C-225C	P-UB-10	2-3/4	7	VME-2551397	104.63
STEERING	2529566		P-U-10	2-1/4	4-1/2	VME-2538179	36.63
	2541515	492A239C; 243C-251C; 253C; 255C-999C; 492A201CAC-	P-UB-10	2-1/4	4-1/2	VME-2542576	53.34
	964804	492A101C-238C; 240C; 241C; 242C; 252C; 254C; 255C	P-UB-10	2-1/4	4-1/2	VME-2542576	53.34
MODEL 275-III							
BUCKET	1503231		P-U-10	2-3/4	7	VME-2516148	70.32
	1543895		P-U-10	2-3/4	7	VME-2516148	70.32
MODEL 275-IIIA							
BUCKET	1503231		P-U-10	2-3/4	7	VME-2516148	70.32
	1543895		P-U-10	2-3/4	7	VME-2516148	70.32
STEERING	1503241		P-U-10	2-1/4	5-1/2	VME-2516094	46.04
	1515236		P-U-10	2-1/4	5-1/2	VME-2516094	46.04
MODEL 475B							
BUCKET	1513011		P-V-10	4-1/2	9	VME-2516230	113.92
	2514104		P-V-10	4-1/2	9	VME-2516230	113.92
STEERING			P-U-10	2-3/4	7	VME-2526058	66.85
			P-UB-10	2-3/4	7	VME-2551397	104.63
	1503659		P-U-10	2-3/4	7	VME-2516148	70.32
	2514101		P-V-10	2-3/4	7	VME-2518494	95.46
MODEL 475C, 475CT							
STEERING	2527900	483A; 487A; 488A	P-U-10	2-3/4	6	VME-2538182	56.49
	2541333	487C; 487B; 483B; 483C	P-UB-10	2-3/4	6	VME-2542568	150.28
	964807	483A; 487A; 488A	P-UB-10	2-3/4	6	VME-2542568	150.28
MODEL 475-IIIA							
BUCKET	1513011		P-V-10	4-1/2	9	VME-2516230	113.92
STEERING	1503659	3AYC101-	P-U-10	2-3/4	7	VME-2516148	70.32
	2514101		P-V-10	2-3/4	7	VME-2518494	95.46
MODEL 675B							
STEERING	1512049	436A	P-V-10	3-1/2	8	VME-2516187	78.52
MODEL L30							
ATTACHMENT	11001980	70118-	P-U-1	20 mm		VME-11990060	33.63
	11005340	-70117	P-U-1	25 mm		VME-11990175	50.61
	4833424	-70117	P-U-1	20 mm		VME-11990060	33.63
LIFT	11001575	70118-	P-U-15	50 mm	100 mm	VME-6630564	55.98
	11005193	-70117	P-U-15	50 mm	100 mm	VME-6630513	47.89
STEERING	11001574	70118-	P-U-15	32 mm	63mm	VME-6630661	61.46
	11005192	-70117	P-U-15	32 mm	63mm	VME-6630661	61.46
TILT	11001576	70118-	P-U-15	40 mm	80 mm	VME-6630662	39.62
	11005194	-70117	P-U-15	40 mm	80 mm	VME-11990106	51.05
MODEL L50							
ATTACHMENT	11005340	ALL	P-U-1	25 mm		VME-11990175	50.61
	4833424	ALL	P-U-1	20 mm		VME-11990060	33.63
LIFT	11005271	6401-; 60301(USA)-	P-U-15	50 mm	90 mm	VME-11990244	44.25
	4782418	-6400; -60300(USA)	P-U-15	40 mm	80 mm	VME-6630560	64.72

Replacement Kits For

VOLVO

VOLVO

Wheel Loaders							
APPLICATION	CYL #	SERIAL #	CODE	ROD	BORE	KIT #	List \$
MODEL L50							
LIFT	4784618	-6400; -60300(USA)	P-U-15	50 mm	100 mm	VME-6630513	47.89
STEERING	4784920	ALL	P-U-15	32 mm	63mm	VME-6630661	61.46
TILT	110052630	6401-; 60301(USA)-	P-U-15	45 mm	80 mm	VME-11990243	25.38
	4782424	-6400; -60300(USA)	P-U-15	50 mm	100 mm	VME-6630562	45.51
	4833111	-6400; -60300(USA)	P-U-15	50 mm	90 mm	VME-6630858	39.32
MODEL L50B							
LIFT	11088016	ALL	P-U-15	60 mm	90 mm	VME-11990438	66.10
STEERING	11005137	ALL	P-U-15	40 mm	63 mm	VME-11990439	48.57
	11088072	ALL	P-U-15	40 mm	63 mm	VME-11990439	48.57
TILT	11088017	ALL	P-U-15	70 mm	125 mm	VME-11990437	56.81
MODEL L70							
ATTACHMENT	11005340	ALL	P-U-1	25 mm		VME-11990175	50.61
	4833424	ALL	P-U-1	20 mm		VME-11990060	33.63
LIFT	11005288	7401-; 60501(USA)-	P-U-15	60 mm	100 mm	VME-11990181	40.18
	4833304	-7400; -60500(USA)	P-UB-15	60 mm	110 mm	VME-11990028	48.97
STEERING	11005388	ALL	P-U-15	36 mm	70 mm	VME-6630909	40.44
	4784940	ALL	P-U-15	36 mm	70 mm	VME-6630909	40.44
TILT	11005284	7401-; 60501(USA)-	P-U-15	50 mm	100 mm	VME-11990180	48.46
	4833399	-7400; -60500(USA)	P-U-15	50 mm	100 mm	VME-6630513	47.89
MODEL L70B							
STEERING	11088289	ALL	P-U-15	40 mm	63 mm	VME-11990439	48.57
MODEL L90							
ATTACHMENT	11005340	ALL	P-U-1	25 mm		VME-11990175	50.61
	4741301	ALL	P-U-1	20 mm		VME-6630475	29.02
	4833424	ALL	P-U-1	20 mm		VME-11990060	33.63
LIFT	11005000	ALL	P-U-15	60 mm	120 mm	VME-11990026	80.31
	11005178	ALL	P-U-15	60 mm	120 mm	VME-11990026	80.31
STEERING	4784553	ALL	P-U-15	50 mm	80 mm	VME-11990050	39.57
TILT	11088064	11016-	P-UB-15	60 mm	110 mm	VME-11990028	48.97
	4833225	-11015	P-UB-15	60 mm	110 mm	VME-11990028	48.97
MODEL L90B							
ATTACHMENT	11005340	ALL	P-U-1	25 mm		VME-11990175	50.61
LIFT	11088062	ALL	P-U-15	60 mm	120 mm	VME-11990026	80.31
STEERING	11088065	ALL	P-U-15	50 mm	80 mm	VME-11990050	39.57
TILT	11088064	ALL	P-UB-15	60 mm	110 mm	VME-11990028	48.97
MODEL L120							
ATTACHMENT	11005340	ALL	P-U-1	25 mm		VME-11990175	50.61
	4741301	ALL	P-U-1	20 mm		VME-6630475	29.02
	4833424	ALL	P-U-1	20 mm		VME-11990060	33.63
LIFT	4833249	ALL	P-U-15	70 mm	140 mm	VME-11990029	114.37
STEERING	4833261	ALL	P-U-15	50 mm	80 mm	VME-11990050	39.57
TILT	4833231	ALL	P-U-15	70 mm	125 mm	VME-11990027	69.75
MODEL L120B							
ATTACHMENT	11005340	ALL	P-U-1	25 mm		VME-11990175	50.61
LIFT	11088048	ALL	P-U-15	70 mm	140 mm	VME-11990404	95.56
STEERING	11088049	ALL	P-U-15	50 mm	80 mm	VME-11990050	39.57
TILT	11088046	ALL	P-UB-15	60 mm	125 mm	VME-11990405	60.27

VOLVO

Replacement Kits For



Wheel Loaders								
APPLICATION	CYL #	SERIAL #	CODE	ROD	BORE	KIT #	List \$	
MODEL L140								
LIFT	2561089	831A; 831AC	P-UB-10	2-3/4	6	VME-2542568	150.28	
TILT	2561088	831A; 831AC	P-UB-10	2-3/4	5	VME-2542569	56.56	
MODEL L150								
ATTACHMENT	11005392	ALL	P-U-15	32 mm	63mm	VME-6630661	61.46	
STEERING	11005294	ALL	P-U-15	50 mm	90 mm	VME-11990347	45.22	
MODEL L160								
ATTACHMENT	11005392	ALL	P-U-15	32 mm	63mm	VME-6630661	61.46	
LIFT	4782979	ALL	P-U-15	60 mm	125 mm	VME-11000107	97.30	
	4782993	ALL	P-U-15	50 mm	100 mm	VME-6630513	47.89	
	4784151	ALL	P-U-15	60 mm	125 mm	VME-11000107	97.30	
	4784247	ALL	P-U-15	28 mm	63 mm	VME-6630749	51.80	
	4833321	ALL	P-U-15	70 mm	140 mm	VME-6630650	74.06	
	11005152	-2704; 60117(USA)-	P-U-15	80 mm	170 mm	VME-6630510	137.25	
	11005153	2705-2981	P-U-15	80 mm	170 mm	VME-6630510	137.25	
	11005247	2982-; 60208(USA)-	P-U-15	80 mm	160 mm	VME-11990158	123.20	
	11005251	2982-	P-U-15	80 mm	160 mm	VME-11990158	123.20	
	4833410	-2704; 60117(USA)-	P-U-15	80 mm	170 mm	VME-6630510	137.25	
	4833411	-2704	P-U-15	80 mm	170 mm	VME-6630510	137.25	
	STEERING	4782803	ALL	P-U-15	50 mm	110mm	VME-6630511	47.46
	TILT	4833412	ALL	P-U-15	70 mm	140 mm	VME-6630938	80.98
MODEL L180								
BRACKET	11005392	ALL	P-U-15	32 mm	63mm	VME-6630661	61.46	
LIFT, HIGH	4782993	ALL	P-U-15	50 mm	100 mm	VME-6630513	47.89	
	4833321	ALL	P-U-15	70 mm	140 mm	VME-6630650	74.06	
STEERING	11005404	ALL	P-U-15	50 mm	100 mm	VME-11990398	38.99	
MODEL L190								
TILT	2562742	828A101-828A672; 828AC673-828AC788	P-UB-10	2-3/4	6	VME-2542568	150.28	
MODEL L270								
LIFT	2561435	827A101-	P-UB-10	4	9	VME-2542574	232.61	
STEERING	12579007	827A101-	P-UB-10	2-3/4	5	VME-2562115	134.74	
	2559738	827A101-	P-UB-10	2-3/4	5	VME-2562115	134.74	
TILT	2561422	827A101-	P-UB-10	3-1/2	7-1/2	VME-2562116	148.10	
MODEL L270B								
LIFT	2561435	827BC00501-	P-UB-10	4	9	VME-2542574	232.61	
STEERING	12579007	827BC00501-	P-UB-10	2-3/4	5	VME-2562115	134.74	
TILT	2561422	827BC00501-	P-UB-10	3-1/2	7-1/2	VME-2562116	148.10	
MODEL L320								
LIFT	2558980	811A101-; 811AC00651-	P-UB-10	4-1/2	9	VME-2562117	207.48	
STEERING	12579807	811A101-; 811AC00651-	P-UB-10	2-3/4	5	VME-2562115	134.74	
TILT	2559495	811A101-; 811AC00651-	P-UB-10	3-1/2	7-1/2	VME-2562116	148.10	
MODEL L480								
STEERING	2541333	830A101-	P-UB-10	2-3/4	6	VME-2542568	150.28	
MODEL L480B								
STEERING	12584868	830BC00301-	P-UB-10	2-3/4	6	VME-2542568	150.28	
MODEL L480T								
STEERING	2541333	829A201-	P-UB-10	2-3/4	6	VME-2542568	150.28	

REPLACEMENT KITS FOR VOLVO EQUIPMENT

VOLVO

Kit Number	Code (Pg. x)	Rod X Bore Size	List Price
VME-11000107	P-U-15	60 X 125 mm	\$ 97.30
VME-11701665-9	P-U-15	70 X 110 mm	39.41
VME-11702311	P-U-10	32 X 70 mm	56.07
VME-11702744	P-UB-10	105 X 150 mm	257.52
VME-11702757	P-UB-10	125 X 170 mm	385.23
VME-11703474	P-UB-10	100 X 150 mm	278.72
VME-11705814	P-UB-10	95 X 140 mm	249.39
VME-11705815	P-UB-10	105 X 150 mm	271.38
VME-11705818	P-UB-10	110 X 160 mm	325.34
VME-11990026	P-U-15	60 X 120 mm	80.32
VME-11990027	P-U-15	70 X 125 mm	69.75
VME-11990028	P-UB-15	60 X 110 mm	48.97
VME-11990029	P-U-15	70 X 140 mm	114.37
VME-11990050	P-U-15	50 X 80 mm	39.57
VME-11990060	P-U-1	20 mm Rod Kit	33.62
VME-11990070	P-U-15	70 X 110 mm	54.13
VME-11990106	P-U-15	40 X 80 mm	51.05
VME-11990158	P-U-15	80 X 160 mm	123.20
VME-11990170-0	P-U-15	80 X 140 mm	142.78
VME-11990175	P-U-1	25 mm Rod Kit	50.62
VME-11990180	P-U-15	50 X 100 mm	48.46
VME-11990181	P-U-15	60 X 100 mm	40.17
VME-11990243	P-U-15	45 X 80 mm	25.38
VME-11990244	P-U-15	50 X 90 mm	44.26
VME-11990347	P-U-15	50 X 90 mm	45.22
VME-11990351-6	P-U-13	70 X 135 mm	142.84
VME-11990398	P-U-15	50 X 100 mm	38.99
VME-11990404	P-U-15	70 X 140 mm	95.56
VME-11990405	P-UB-15	60 X 125 mm	60.26
VME-11990437	P-U-15	70 X 125 mm	56.81
VME-11990438	P-U-15	60 X 90 mm	66.10
VME-11990439	P-U-15	40 X 63 mm	48.57
VME-11991589	75,120,140 mm Telescopic		149.27
VME-11993103	75,120,140 mm Telescopic		120.26
VME-11993103-8	75,120,140 mm Telescopic		124.72
VME-11993411	75,95,105,120,140 mm Telescopic		232.61
VME-11997089-5	P-U-14	105 X 160 mm	443.88
VME-11997091-1	P-UB-14	90 X 140 mm	353.49
VME-11997225	P-U-15	80 X 125 mm	208.82
VME-11997226	P-U-14	105 X 150 mm	307.23
VME-11997227	P-U-14	50 X 70 mm	176.65
VME-11999887	P-UB-10	32 X 70 mm	71.96
VME-12724303	I-U-5	2 X 4 mm	55.78
VME-12724304	I-U-5	1-3/8 X 3	54.92
VME-12969637	Valve Kit		18.36
VME-1991086	P-U-10	1-3/4 X 3-1/2	31.16
VME-1991089	PTR-10	2-3/4 X 6	69.54
VME-2516054	P-V-10	2-1/4 X 4-1/4	33.51
VME-2516055	I-U-10	1 X 2-1/2	16.96
VME-2516058	P-U-10	2-1/4 X 5	38.12

Kit Number	Code (Pg. x)	Rod X Bore Size	List Price
VME-2516059	P-U-10	2 X 5	\$ 47.04
VME-2516060	I-U-10	2-1/4 X 5	32.01
VME-2516061	P-U-10	2-1/4 X 5	45.22
VME-2516065	P-V-10	2-3/4 X 6	53.60
VME-2516070	P-V-10	2-1/4 X 4-1/2	44.77
VME-2516071	P-V-10	1-3/4 X 3-1/2	35.51
VME-2516072	I-U-10	1-3/4 X 3-1/2	26.48
VME-2516073	P-U-10	2 X 3-1/2	32.73
VME-2516088	P-U-10	2 X 4	46.99
VME-2516090	P-U-10	2 X 4	31.23
VME-2516094	P-U-10	2-1/4 X 5-1/2	46.04
VME-2516148	P-U-10	2-3/4 X 7	70.32
VME-2516151	P-V-10	2 X 4-1/2	30.81
VME-2516152	P-V-10	2-1/4 X 4-1/2	40.49
VME-2516155	P-V-10	2-3/4 X 7	101.29
VME-2516156	I-U-10	2-1/4 X 5-1/4	36.45
VME-2516187	P-U-10	3-1/2 X 8	78.51
VME-2516228	I-U-10	3-1/2 X 9	89.86
VME-2516230	P-V-10	4-1/2 X 9	113.92
VME-2516242	P-V-10	3-1/2 X 9	102.63
VME-2516270	P-U-10	1-3/4 X 3-1/2	35.76
VME-2516271	P-V-10	2 X 4-1/2	36.91
VME-2516272	I-U-10	1-1/4 X 2-1/2	17.91
VME-2516274	P-V-10	2-1/4 X 5-1/4	37.97
VME-2518493	P-V-10	2-3/4 X 6	64.18
VME-2518494	P-V-10	2-3/4 X 7	95.46
VME-2526058	P-U-10	2-3/4 X 7	66.85
VME-2530107	P-U-10	2 X 4	32.72
VME-2530108	P-U-10	2-1/4 X 5	39.04
VME-2538174	P-U-10	1-3/4 X 3-1/2	26.54
VME-2538177	P-U-10	1-3/4 X 3-1/2	39.52
VME-2538178	P-U-10	2 X 4-1/2	34.23
VME-2538179	P-U-10	2-1/4 X 4-1/2	36.63
VME-2538180	P-U-10	3-1/2 X 9	117.40
VME-2538181	P-U-10	2-1/4 X 5-1/4	45.99
VME-2538182	P-U-10	2-3/4 X 6	56.50
VME-2538183	P-U-10	2-3/4 X 7	59.56
VME-2538187	P-U-10	2-3/4 X 5	38.65
VME-2538193	P-U-10	4 X 9	125.02
VME-2541637	P-U-10	3 X 7	72.13
VME-2542568	P-UB-10	2-3/4 X 6	150.28
VME-2542569	P-UB-10	2-3/4 X 5	56.56
VME-2542570	P-UB-10	1-3/4 X 3-1/2	50.80
VME-2542571	P-UB-10	3 X 7	128.15
VME-2542574	P-UB-10	4 X 9	232.61
VME-2542576	P-UB-10	2-1/4 X 4-1/2	53.34
VME-2542577	P-UB-10	2-1/4 X 5	63.98
VME-2551396	P-UB-10	3-1/2 X 9	171.74
VME-2551397	P-UB-10	2-3/4 X 7	104.63
VME-2551398	P-UB-10	2 X 4-1/2	49.54

REPLACEMENT KITS FOR VOLVO EQUIPMENT

Kit Number	Code (Pg. x)	Rod X Bore Size	List Price
VME-2551399	P-UB-10	2-1/4 X 5-1/4	\$ 71.79
VME-2551403	P-UB-10	2 X 4	47.18
VME-2562115	P-UB-10	2-3/4 X 5	134.74
VME-2562116	P-UB-10	3-1/2 X 7-1/2	148.10
VME-2562117	P-UB-10	4-1/2 X 9	207.48
VME-6213407	70,105,120,140 mm Telescopic		233.83
VME-6630100	75,90,105,120,140,160 mm Telescopic		195.09
VME-6630443	P-U-15	70 X 100 mm	42.88
VME-6630443-7	P-U-15	70 X 100 mm	42.97
VME-6630475	P-U-1	20 mm Rod Kit	29.02
VME-6630510	P-U-15	80 X 170 mm	137.25
VME-6630511	P-U-15	50 X 110 mm	47.47
VME-6630513	P-U-15	50 X 100 mm	47.89
VME-6630560	P-U-15	40 X 80 mm	64.72
VME-6630562	P-U-15	50 X 100 mm	45.51
VME-6630564	P-U-15	50 X 100 mm	55.99

Kit Number	Code (Pg. x)	Rod X Bore Size	List Price
VME-6630650	P-U-15	50 X 100 mm	\$ 74.06
VME-6630661	P-U-15	32 X 63 mm	61.46
VME-6630662	P-U-15	40 X 80 mm	39.61
VME-6630839	60,75,90,105,120,140 mm Telescopic		196.30
VME-6630843	P-U-15	60 X 100 mm	45.38
VME-6630843-8	P-U-15	60 X 100 mm	44.33
VME-6630852	75,90,105,120,140,160 mm Telescopic		221.62
VME-6630858	P-U-15	50 X 90 mm	39.33
VME-6630909	P-U-15	36 X 70 mm	40.44
VME-6630938	P-U-15	70 X 140 mm	80.98
VME-814816020	P-UB-14	105 X 160 mm	309.85
VME-814816030	P-UB-14	105 X 150 mm	257.00
VME-814816040	P-UB-14	115 X 170 mm	362.33
VME-814816130	P-UB-14	105 X 160 mm	309.85
VME-814816140	P-UB-14	115 X 170 mm	362.33
VME-814816150	P-UB-14	1015 X 150 mm	257.00

WABCO TRUCKS

Kit Number	Code (Pg. x)	Rod X Bore Size	List Price
WBC-587294	3 Stage Tele.	6-1/4, 8-1/8, 9-3/4	\$ 666.14
WBC-AK0076	2-1/2 X 5	P-U-10	94.98
WBC-AK0700	3 Stage Tele	3-3/4, 5-1/4, 6-3/4	290.01
WBC-RK1655	3 Stage Tele.	3-3/4, 5-1/4, 6-3/4	352.47

WALTCO LIFT GATE

Kit Number	Code (Pg. x)	Rod X Bore Size	List Price
WC-1111-5	1-1/4 X 4	I-OB-10	\$ 8.48
WC-20280095	1-3/4 X 4	I-OB-10	9.65
WC-2500	1-3/4 X 4	I-OB-10	7.17
WC-70270081	2 X 4-3/4	I-OB-3	7.48
WC-70270091	2 X 4-3/4	N-OB-3	5.25
WC-70270681	2 X 4-3/4	I-U-4	20.08
WC-LD-81	1-1/4 X 4	I-OB-10	8.73



KINGSEAL CO., LTD. THAILAND

46/152-153 Moo 3 Sri Saman Road
Baan Mai Pakkret, Nonthaburi Thailand 11120

Tel: +662 9617534 to 6

Fax: +662 9617540

Email: intlsales@kingseal.co.th / kingsealmail@gmail.com

Website: <http://www.kingseal.co.th>

WARD TELESCOPIC CYLINDER PARTS

PACKING: Vee packing with top and bottom adapters. All .275 c.s.
WIPERS: Urethane snap-in type.
BEARINGS: Originally nylon, reinforced with metal. Outer bearing is flat on both sides. Inner bearing is step-cut on o.d. to pilot over snap ring.
PISTON: Steel, welded to stage. Double action has 3 replaceable nylon wear rings and 2 cast iron piston rings in separate grooves. Single action has 2 replaceable nylon wear rings.
STAGE O.D.'s: 3.950", 4.950", 5.950", 6.950", 7.950", 8.950"
SPECIAL INFO. 1/4" spring steel snap ring serves as internal stop. Gland collars are cast steel, have square reliefs in casting and "ears" on bottom of gland collar for set screw.

WARD CO

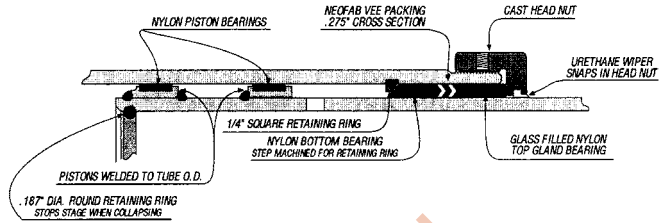

Part Number	Description	List Price
PACKING & WIPER		
WD-3VSW	2.950" I.D. Vee Set & Wiper	\$ 13.88
WD-4VSW	3.950" I.D. Vee Set & Wiper	16.88
WD-5VSW	4.950" I.D. Vee Set & Wiper	21.42
WD-6VSW	5.950" I.D. Vee Set & Wiper	27.09
WD-7VSW	6.950" I.D. Vee Set & Wiper	32.99
WD-8VSW	7.950" I.D. Vee Set & Wiper	39.64
WD-9VSW	8.950" I.D. Vee Set & Wiper	53.10
TOP BEARINGS		
WD-4NGTB	3.950" I.D. Top Bearing	\$ 33.55
WD-5NGTB	4.950" I.D. Top Bearing	37.99
WD-6NGTB	5.950" I.D. Top Bearing	39.74
WD-7NGTB	6.950" I.D. Top Bearing	54.93
WD-8NGTB	7.950" I.D. Top Bearing	68.77
WD-9NGTB	8.950" I.D. Top Bearing	69.71
BOTTOM BEARINGS		
WD-4NGBB	3.950" I.D. Bottom Bearing	\$ 33.55
WD-5NGBB	4.950" I.D. Bottom Bearing	37.99
WD-6NGBB	5.950" I.D. Bottom Bearing	54.52
WD-7NGBB	6.950" I.D. Bottom Bearing	54.93
WD-8NGBB	7.950" I.D. Bottom Bearing	68.77
WD-9NGBB	8.950" I.D. Bottom Bearing	69.71
PISTON WEAR RINGS		
WD310-737-40	4-1/2" O.D. Piston Wear Rings	\$ 3.01
WD310-737-50	5-1/2" O.D. Piston Wear Rings	3.01
WD310-764-60	6-1/2" O.D. Piston Wear Rings	3.95
WD310-764-70	7-1/2" O.D. Piston Wear Rings	4.61
WD310-764-80	8-1/2" O.D. Piston Wear Rings	6.78
WD310-764-90	9-1/2" O.D. Piston Wear Rings	8.06
SNAP RINGS		
WD560-009-40	4-1/2" Stage I.D. Snap Ring	\$ 53.72
WD560-009-90	9-1/2" Stage I.D. Snap Ring	76.20

Part Number	Description	List Price
PISTON RINGS - DOUBLE ACTION ONLY		
WD505-066-17	4-1/2" O.D. Piston Ring	\$ 8.95
WD505-066-24	5-1/2" O.D. Piston Ring	12.49
WD505-066-28	6-1/2" O.D. Piston Ring	14.44
WD505-066-35	7-1/2" O.D. Piston Ring	29.15
WD505-066-38	8-1/2" O.D. Piston Ring	32.50
WD505-066-40	9-1/2" O.D. Piston Ring	46.64
KITS		
WD-48	4" - 8" Vee Sets & Wipers	\$ 144.91
WD-49	4" - 9" Vee Sets & Wipers	200.65
WD-BNB48	4" - 8" Bottom Bearings	249.75
WD-BNB49	4" - 9" Bottom Bearings	319.45
WD-PR48	4-1/2" - 8-1/2" Piston Rings	157.42
WD-PR49	4-1/2" - 9-1/2" Piston Rings	241.42
WD-SR48	4" - 8" Snap Rings	289.90
WD-SR49	4" - 9" Snap Rings	365.38
WD-TNB48	4" - 8" Top Bearings	234.90
WD-TNB49	4" - 9" Top Bearings	304.68
WD-WR48	4-1/2" - 8-1/2" Piston Wear Rings	64.12
WD-WR49	4-1/2" - 9-1/2" Piston Wear Rings	85.86

WHITE LIFT TRUCK

Kit Number	Code (Pg. x)	Rod X Bore Size	List Price
WLT-20-7300283	I-U-4	1-3/4 X 4	\$ 36.10
WLT-20-7302715	I-U-10	1-1/2 X 3-1/2	20.12
WLT-30-3305457	P-U-10	1-1/2 X 3-1/2	20.57

WHITEMAN / CONSPRAY

Kit Number	Code (Pg. x)	Rod X Bore Size	List Price
WCS-02KS-4963	3 X 4	I-U-11	\$ 24.50
WCS-02KS-4964	3-1/2 X 8	I-U-5	100.42
WCS-02KS-4966	5-1/2 X 6-1/2	I-U-10	95.23
WCS-02KS-85A	Pump Kit		9.14
WCS-02KS-954	6" Rod Kit		63.93
WCS-05KS-8451	1-3/4 X 3-1/4	I-U-10	37.70

YALE LIFT TRUCKS

Kit Number	Code (Pg. x)	Rod X Bore Size	List Price
YA-066414600	4-1/16 Rod Wiper		\$ 8.41
YA-5001689-04	VEE SET		24.88
YA-502566003	I-N-8	2-1/2 X 3-1/2	73.37
YA-502566004	I-N-8	2 X 3-1/2	70.10
YA-503130000	P-V-4	2 X 3-1/4	35.57
YA-504236229	P-U-10	2-1/8 X 2-3/4	42.47
YA-504236245	P-U-10	1-3/8 X 3	22.95
YA-504853000	I-U-5	1-1/4 X 3	52.24
YA-504857000	I-N-8	2-1/4 X 4	24.12
YA-5048620	I-N-8	1-3/4 X 2-1/2	14.87
YA-505136003	I-N-8	2-1/2 X 3-1/2	30.11
YA-505136004	I-N-8	2 X 3-1/2	25.15
YA-505136007	I-U-1	1-5/8 X 2-1/4	11.87
YA-505136008	I-U-1	1-5/16 X 2-1/4	11.62
YA-505136009	I-U-1	3-1/4" Rod	17.72
YA-505136010	I-U-1	1-7/8 X 2-1/2	11.17
YA-505136012	I-U-11	1-7/8 X 2-1/4	34.95
YA-505136014	I-U-1	3-3/4 ROD	16.72
YA-505136015	I-U-10	2-5/8 X 3	53.21
YA-505136027	I-U-1	1-5/8 X 2	14.55
YA-505136028	I-U-4	1-3/8 x 2	47.73
YA-505136031	I-U-1	3 X 3-3/4	18.21
YA-505136035	I-U-4	1-3/8 X 2	29.78
YA-505136036	I-U-4	1-5/8 X 2	25.09
YA-505136037	I-U-12	1-3/8 X 2	30.92
YA-505136040	I-U-4	1-5/8 X 1-7/8	27.88
YA-505136059	I-U-1	1-1/4 X 1-3/4	14.53
YA-505142000	I-V-1	3-3/8, 4-1/16 Stages	59.14
YA-505143000	I-V-1	2-1/2, 3 Stages	42.25
YA-505163001	ROD KIT		9.31
YA-506785001	I-N-8	2-1/4 X 4	107.69
YA-506786002	I-N-8	2-3/4 X 4	43.14
YA-506787001	I-N-8	2-3/4 X 4-1/2	114.64
YA-506788001	I-N-8	2-3/4 X 4-1/2	50.02
YA-507016002	I-V-5	1-1/2 x 4	41.62
YA-509753000	I-V-12	1 X 2	19.59

YALE LIFT TRUCKS

Kit Number	Code (Pg. x)	Rod X Bore Size	List Price
YA-510078000	I-U-5	1 X 2-1/2	\$ 20.85
YA-510398000	I-V-1	2-1/4, 3, 3-3/4 Stages	86.90
YA-510659001	I-V-2	1-1/4 X 3-1/2	23.45
YA-512944003	I-U-10	1 X 2	12.66
YA-513355800	O-RING KIT		2.48
YA-514527000	I-V-1	3, 3-3/4 Stages	55.29
YA-515229000	I-U-4	2-1/4 X 3-3/4	27.03
YA-516149002	I-U-11	1 X 2	17.07
YA-516149005	I-U-11	1 X 2	13.64
YA-516149006	I-U-11	1-1/8 X 2-1/2	16.84
YA-5178128-17	SHAFT KIT		1.14
YA-518617001	I-V-10	1-1/4 X 2-1/2	42.20
YA-519132600	I-U-5	1-3/4 X 3-1/2	29.57
YA-519675801	O-RING KIT		4.49
YA-900299851		65 mm, 80 mm 2 Stage	31.08
YA-900847850	P-U-10	25 X 60 mm	28.03
YA-900879850	I-U-3	35 X 80 mm	11.63
YA-901115850	P-U-1	32 mm Rod Kit	26.40
YA-9012238-07	P-U-10	40 X 70 mm	43.12
YA-9017888-10	P-U-10	35 X 70 mm	33.93
YA-9019058-52	P-U-10	35 X 65 mm	52.07
YA-9022018-50	SHAFT KIT		7.65
YA-9042841-00	VALVE KIT		67.73

YAN MAR EXCAVATORS

Kit Number	Code (Pg. x)	Rod X Bore Size	List Price
YAN-172147-99340	P-U-14	55 X 95 mm	\$ 86.79
YAN-172425-72500	P-U-1	55 mm Rod Kit	21.73
YAN-172425-72600	N-N-14	90 mm Piston Kit	22.53
YAN-933138-70699	P-U-5	40 X 88 mm	80.35
YAN-933711-33599	P-U-5	50 X 80 mm	39.96
YAN-933711-34799	P-U-5	40 X 75 mm	91.16

YOUNG GRAPPLE

Kit Number	Code (Pg. x)	Rod X Bore Size	List Price
YG-14004MS	P-U-5	2-1/2 X 5	\$ 103.75
YG-15813	P-U-5	2-1/2 X 5	97.32
YG-17570	I-U-5	2 X 4	86.07
YG-587V068	P-UB-10	2 X 4	41.18
YG-587V326	I-U-14	4-1/2 X 7	148.21
YG-587V74	P-UB-10	2 X 4-1/2	48.35

Replacement Kits For

YUTANI

Tracked Excavators

APPLICATION	CYL #	CODE	ROD	BORE	KIT #	List \$
MODEL MD-120LC						
ARM	2438U983F1	P-UB-1	80 mm		YUT-2438U928R100	99.23
BOOM L	2438U923F1	P-UB-1	70 mm		YUT-2438U922R100	68.04
BOOM R	2438U922F1	P-UB-1	70 mm		YUT-2438U922R100	68.04
BUCKET	2438U897F1	P-UB-1		100 mm	YUT-2438U897R110	64.25
	2438U897F1	P-UB-1	65 mm		YUT-2438U897R100	57.23
MODEL MD-140BLC						
ARM	2438U973F1	P-UB-1	80 mm		YUT-2438U973R100	112.02
	2438U973F1	N-N-10		120 mm	YUT-2438U973R200	149.07
BOOM L	2438U972F2	N-N-10		105 mm	YUT-2438U971R200	106.11
	2438U972F2	P-UB-1	70 mm		YUT-2438U971R100	70.23
BOOM R	2438U971F2	N-N-10		105 mm	YUT-2438U971R200	106.11
	2438U971F2	P-UB-1	70 mm		YUT-2438U971R100	70.23
BUCKET	2438U974F1	N-N-10		100 mm	YUT-2438U974R200	108.67
	2438U974F1	P-UB-10	65 mm		YUT-2438U974R100	56.33
MODEL MD-180LC						
ARM	2438U921F1	N-N-10		145 mm	YUT-2438U921R110	136.48
	2438U921F1	P-UB-1	95 mm		YUT-2438U921R100	71.02
	2438U921F2	N-N-10		145 mm	YUT-2438U921R110	136.48
	2438U921F2	P-UB-1	95 mm		YUT-2438U921R100	71.02
BOOM	2438U982F1	P-UB-1	95 mm		YUT-2438U921R100	71.02
	2438U914D1F1	P-UB-1	85 mm		YUT-2438U914R100	75.98
	2438U914D2F1	P-UB-1	85 mm		YUT-2438U914R100	75.98
BOOM L	2438U981F1	P-UB-1	85 mm		YUT-2438U914R100	75.98
BOOM R	2438U980F1	P-UB-1	85 mm		YUT-2438U914R100	75.98
BUCKET	2438U915F1	P-UB-1	75 mm		YUT-2438U915R100	57.41
	2438U915F1	N-N-10		120 mm	YUT-2438U915R110	108.81
MODEL MD-200BLC						
ARM	2438U941F1	N-N-14		145 mm	YUT-2438U941R200	187.45
	2438U941F1	P-UB-1	100 mm		YUT-2438U941R100	198.33
BOOM L	2438U996F1	N-N-14		125 mm	YUT-2438U996R200	183.44
	2438U996F1	P-UB-1	85 mm		YUT-2438U996R100	87.20
BOOM R	2438U997F1	P-UB-1	85 mm		YUT-2438U996R100	87.20
	2438U997F1	N-N-14		125 mm	YUT-2438U996R200	183.44
BUCKET	2438U995F1	N-N-14		120 mm	YUT-2438U995R200	158.45
	2438U995F1	P-UB-1	80 mm		YUT-2438U995R100	85.86
MODEL MD-240BLC						
ARM	2438U953F1	P-UB-1	105 mm		YUT-2438U953R100	170.14
	2438U953F1	N-N-10		150 mm	YUT-2438U953R200	156.27
BOOM L	2438U1000F1	P-UB-1	90 mm		YUT-2438U999R100	83.74
	2438U1000F1	N-N-10		140 mm	YUT-2438U999R200	161.28
BOOM R	2438U999F1	P-UB-1	90 mm		YUT-2438U999R100	83.74
	2438U999F1	N-N-10		140 mm	YUT-2438U999R200	161.28
BUCKET	2438U959F1	N-N-10		130 mm	YUT-2438U959R200	120.25
	2438U959F1	P-UB-1	85 mm		YUT-2438U959R100	90.09
MODEL MD-300LC						
ARM	2438U1323F1	P-UB-1	110 mm		YUT-2438U1323R100	174.08
	2438U1323F1	N-N-10		160 mm	YUT-2438U1323R110	214.52
BOOM	2438U776F1	N-N-10		150 mm	YUT-2438U776R110	167.33

Replacement Kits For

YUTANI

YUTANI

Tracked Excavators						
APPLICATION	CYL #	CODE	ROD	BORE	KIT #	List \$
MODEL MD-300LC						
BOOM	2438U776F1	P-UB-1	95 mm		YUT-2438U776R100	103.41
BUCKET	2438U1324F1	P-UB-1	100 mm		YUT-2438U1324R100	142.63
	2438U1324F1	N-N-10		150 mm	YUT-2438U1324R110	126.81
MODEL MD-450BLC						
ARM	2438U1029F1	N-N-14		180 mm	YUT-2438U1029R200	171.18
BOOM	2438U1029F1	P-UB-1	130 mm		YUT-2438U1029R100	155.11
	2438U1028D1F1	P-UB-1	110 mm		YUT-2438U1028R100	96.14
	2438U1028D1F1	N-N-14		170 mm	YUT-2438U1028R200	238.25
	2438U1028D2F1	P-UB-1	110 mm		YUT-2438U1028R100	96.14
	2438U1028D2F1	N-N-14		170 mm	YUT-2438U1028R200	238.25
BUCKET	2438U1030F1	P-UB-1	120 mm		YUT-2438U1030R100	119.88
	2438U1030F1	N-N-14		170 mm	YUT-2438U1030R200	238.25

REPLACEMENT KITS FOR YUTANI EQUIPMENT

Kit Number	Description	List Price	Kit Number	Description	List Price
YUT-2438U1028R100	110 mm Rod Kit	\$ 96.14	YUT-2438U928R100	80 mm Rod Kit	\$ 99.23
YUT-2438U1028R200	170 mm Piston Kit	238.25	YUT-2438U941R100	100 mm Rod Kit	198.33
YUT-2438U1029R100	130 mm Rod Kit	155.11	YUT-2438U941R200	145 mm Piston Kit	187.45
YUT-2438U1029R200	180 mm Piston Kit	171.18	YUT-2438U953R100	105 mm Rod Kit	170.14
YUT-2438U1030R100	120 mm Rod Kit	119.88	YUT-2438U953R200	150 mm Piston Kit	156.27
YUT-2438U1030R200	170 mm Piston Kit	238.25	YUT-2438U959R100	85 mm Rod Kit	90.09
YUT-2438U1323R100	110 mm Rod Kit	174.08	YUT-2438U959R200	130 mm Piston Kit	120.25
YUT-2438U1323R110	160 mm Piston Kit	214.52	YUT-2438U971R100	70 mm Rod Kit	70.23
YUT-2438U1324R100	100 mm Rod Kit	142.63	YUT-2438U971R200	105 mm Piston Kit	106.11
YUT-2438U1324R110	150 mm Piston Kit	126.81	YUT-2438U973R100	80 mm Rod Kit	112.02
YUT-2438U776R100	95 mm Rod Kit	103.41	YUT-2438U973R200	120 mm Piston Kit	149.07
YUT-2438U776R110	150 mm Piston Kit	167.33	YUT-2438U974R100	65 mm Rod Kit	56.33
YUT-2438U897R100	65 mm Rod Kit	57.23	YUT-2438U974R200	100 mm Piston Kit	108.67
YUT-2438U897R110	100 mm Piston Kit	64.25	YUT-2438U985R200	180 mm Piston Kit	186.56
YUT-2438U914R100	85 mm Rod Kit	75.98	YUT-2438U995R100	80 mm Rod Kit	85.86
YUT-2438U915R100	75 mm Rod Kit	57.41	YUT-2438U995R200	120 mm Piston Kit	158.45
YUT-2438U915R110	120 mm Piston Kit	108.81	YUT-2438U996R100	85 mm Rod Kit	87.20
YUT-2438U921R100	95 mm Rod Kit	71.02	YUT-2438U996R200	125 mm Piston Kit	183.44
YUT-2438U921R110	145 mm Piston Kit	136.48	YUT-2438U999R100	90 mm Rod Kit	83.74
YUT-2438U922R100	70 mm Rod Kit	68.04	YUT-2438U999R200	140 mm Piston Kit	161.28



NOTES

Kingseal Co., Ltd. Thailand

Kits & Tools

Contents	Page
O-Ring Assortment Kits	506 - 515
O-Ring Splice Kits	516
Back-Up Ring Assortment Kits	517 - 518
Rubber U-Cup Assortment Kit	518
Retainer Ring Assortment Kits	519 - 520
Cap Plug Assortment Kit	521
Caterpillar Assortment Kits	521
Cotter Pin Assortment Kit	522
Woodruff Key Assortment Kit	522
Grease Fitting Assortment Kit	522
Rod U-Seal Installation Tools	523
Pump & Motor Shaft Seal Installation Tools	523
Port Seal Assembly Tool	523
O-Ring Pick Sets	524
5 Piece Tool Kit Set	525
Chevron Assembly Tool	525
Packing Hooks	525
Replaceable Woodscrew Tips	526
Replaceable Corkscrew Tips	526
Solid Shaft Pick	526
11 & 17 Piece Packing Tool Kits	527
O-Ring Measuring Cone	528
Digital Calipers	528
Pi Tapes	528
O-Ring Sizing Chart	529
Punch Set	529

O-RING KITS

O-RING KIT

Part Number: 568 Kit-A

List Price: \$ 26.46

PART NUMBER	QTY	PART NUMBER	QTY
006-012	20	210-222	10
110-116	13	325-327	7

This kit contains a total of 382 O-Rings in 30 different sizes, providing an extremely low cost per size value.



O-RING METRIC KIT

Part Number: Metric O Kit-J-A

List Price: \$ 34.74

I.D X C.S. (mm)	QTY	I.D X C.S. (mm)	QTY
3 X 2.0	16	20 X 3.0	12
4 X 2.0	16	22 X 3.0	12
5 X 2.0	16	24 X 3.0	12
6 X 2.0	16	25 X 3.0	12
7 X 2.0	16	27 X 3.0	12
8 X 2.0	16	28 X 3.0	12
10 X 2.0	16	30 X 3.0	12
10 X 2.5	16	32 X 3.0	12
11 X 2.5	13	33 X 3.0	12
12 X 2.5	13	35 X 3.0	12
14 X 2.5	13	36 X 3.0	12
16 X 2.5	13	38 X 3.0	12
17 X 2.5	13	38 X 4.0	9
19 X 2.5	13	41 X 4.0	9
19 X 3.0	12	44 X 4.0	9

The Metric O-Kit J-A contains a total of 389 O-Rings in 30 different sizes, another extremely low cost per size value.

O-RING KITS

O-RING MINI KIT

Part Number: 568 Mini Kit

List Price: \$ 11.58

PART NUMBER	QTY	PART NUMBER	QTY
006	20	110	10
007	20	111	10
008	20	112	10
009	15	113	10
010	15	114	10
011	15	115	10
012	10	116	10
014	10	210	10
016	10	211	10

This popular mini kit contains a total of 225 O-Rings in 18 different sizes.



O-RING METRIC MINI KIT

Part Number: Metric Mini Kit-J

List Price: \$ 13.73

I.D X C.S. (mm)	QTY	I.D X C.S. (mm)	QTY
3 X 2.0	20	10 X 2.5	10
4 X 2.0	20	11 X 2.5	10
5 X 2.0	20	12 X 2.5	10
6 X 2.0	15	14 X 2.5	10
7 X 2.0	15	16 X 2.5	10
8 X 2.0	15	17 X 2.5	10
10 X 2.0	10	19 X 2.5	10
12 X 2.0	10	19 X 3.0	10
14 X 2.0	10	20 X 3.0	10

The Metric version of the Mini O-ring kit also contains a total of 225 O-Rings in 18 different sizes.



O-RING KITS

U.S. INDUSTRIAL O-RING KIT

Part Number: 568 Kit
List Price: \$ 32.71

PART NUMBER	QTY	PART NUMBER	QTY
005-011	25	111-116	10
012	15	117-121	7
013-018	10	210-211	10
110	15	212-219	7

This kit contains a total of 436 70 Durometer O-Rings in 36 different sizes, providing an extremely low cost per size value.



O-RING WAREHOUSE KIT

Part Number: 568 WH Kit
List Price: \$ 259.67

PART NUMBER	QTY	PART NUMBER	QTY
001-016	20	217-229	5
017-024	10	230-232	3
025-031	7	233-237	2
032-043	5	325-328	5
044-046	2	329-330	4
110-116	15	331-338	2
117-124	10	901-914	5
125-142	5	916, 918	5
143-146	3	920, 924	5
147-151	2	928, 932	5
210-216	10		

Our O-ring Warehouse kit is ideally suited for the repair shop that needs a large on-hand selection of O-rings to insure quick repair of all machine types. 1,110 O-Rings in 150 different sizes are included in this kit. Each size is individually packaged in heavy duty ziploc bags to protect against environmental exposure and contamination. All packages are then stored in a sturdy styrene cabinet with pull-out drawers for easy access to parts. Included card shows size, dimensions, and drawer location for each ring.

QUAD WAREHOUSE KIT

Part Number: Quad-Ring WH Kit
List Price: \$ 424.00

PART NUMBER	QTY	PART NUMBER	QTY
QR-4004-012	10	QR-4125-135	3
QR-4013-030	5	QR-4136-154	2
QR-4031-038	3	QR-4204-216	5
QR-4039-048	2	QR-4217-229	3
QR-4108-116	10	QR-4230-338	2
QR-4117-124	5		



Similar to the O-Ring Warehouse kit, the Quad Seal Warehouse kit contains a total of 583 four-lobed seals in 145 different sizes. This kit is ideal for the small distributor who wishes to have a comprehensive on-hand inventory of Quad seals for counter sales.

O-RING KITS

90 DUROMETER O-RING KIT

Part Number: 568 90D Kit

List Price: \$ 46.58

PART NUMBER	QTY	PART NUMBER	QTY
005-011-90D	25	111-116-90D	10
012-90D	15	117-121-90D	7
013-018-90D	10	210-211-90D	10
110-90D	15	212-219-90D	7

This kit contains a total of 436 90 Durometer O-Rings in 36 different sizes, providing an extremely low cost per size value.



Our 90 Durometer O-ring Warehouse kit is ideally suited for the repair shop that needs a large on-hand selection of O-Rings to insure quick repair of all machine types. 1,110 O-Rings in 150 different sizes are included in this kit.



90 DUROMETER O-RING WAREHOUSE KIT

Part Number: 568 WH Kit-90D

List Price: \$ 264.58

PART NUMBER	QTY	PART NUMBER	QTY
001-016-90D	20	217-229-90D	5
017-024-90D	10	230-232-90D	3
025-031-90D	7	233-237-90D	2
032-043-90D	5	325-328-90D	5
044-046-90D	2	329-330-90D	4
110-116-90D	15	331-338-90D	2
117-124-90D	10	901-914-90D	5
125-142-90D	5	916, 918-90D	5
143-146-90D	3	920, 924-90D	5
147-151-90D	2	928, 932-90D	5
210-216-90D	10		

900 BOSS O-RING KIT

Part Number: 900 Boss Kit

List Price: \$ 21.44

PART NUMBER	QTY
904	35
905-906	30
907-910	20
911-914	15
916	15



This 250 piece assortment contains the most popular size 90 Durometer Boss O-rings, individually boxed, which will supply your shop, service truck, or parts counter with the sizes you need!

O-RING KITS**MAX O-RING KIT**

Part Number: MAX 1381 Kit **Part Number:** MAX 1381 Kit-90D
List Price: \$ 274.37 **List Price:** \$ 280.90

These sturdy kits, packaged in a heavy duty box, contains 1415 O-Rings in the most popular sizes. Every service truck should have one of these. Five internal boxes contain 1/16" C/S, 3/32" C/S, 1/8" C/S, Boss and Flange fitting o-rings. Contents and quantities are listed below.

Flange Seals

FLANGE NUMBER	QTY	FLANGE NUMBER	QTY
8	10	20	5
12	10	24	5
16	10	32	5

Boss O-Rings

BOSS NUMBER	QTY	BOSS NUMBER	QTY
903	15	907	25
904	25	910	25
906	15	912	15
906	25	916	10

1/16" C/S O-Rings

O-RING NUMBER	QTY	O-RING NUMBER	QTY
006 - 118	25	028	15
019 - 021	20	029	10
022 - 026	15	030	10

**3/32" C/S O-Rings**

O-RING NUMBER	QTY	O-RING NUMBER	QTY
109 - 118	25	129	10
119 - 120	20	131	10
121 - 127	15	133	10
128	10	135	5

1/8" C/S O-Rings

O-RING NUMBER	QTY	O-RING NUMBER	QTY
210 - 214	20	228	10
215 - 222	15	232	10
223 - 224	10	236	10
226	10		

FLUOROCARBON O-RING KIT

Part Number: 568 FC Kit
List Price: \$ 195.97

PART NUMBER	QTY	PART NUMBER	QTY
005-011V	25	111-116V	10
012V	15	117-121V	7
013-018V	10	210-211V	10
110V	15	212-219V	7

This kit contains a total of 436 75 Durometer Fluorocarbon O-Rings in 36 different sizes, providing an extremely low cost per size value.

O-RING KITS

900 BOSS FLUOROCARBON O-RING KIT

Part Number: 900 Boss FC
List Price: \$ 137.80

PART NUMBER	QTY
904V	35
905-906V	30
907-910V	20
911-914V	15
916V	15

This 250 piece assortment contains the most popular size 90 Durometer Boss O-rings, individually boxed, which will supply your shop, service truck, or parts counter with the sizes you need!



PTFE O-RING KIT

Part Number: 568 PTFE Kit
List Price: \$ 406.79

PART NUMBER	QTY
005-012T	15
013-018T	10
110-116T	10
117-121T	5
210-219T	5

This kit contains a total of 325 PTFE O-Rings (55 - 58 Shore D) in 36 different sizes. PTFE O-Rings can withstand temperatures up to 500° F and are impervious to a wide range of chemicals.



QUAD RING KIT

Part Number: Quad-Ring Kit
List Price: \$ 77.17

PART NUMBER	QTY	PART NUMBER	QTY
4005-4012	10	4110-4116	6
4013-4016	6	4117-4121	4
4017-4018	5	4210-4219	5

This kit contains a total of 226 Quad Seals in 36 different sizes, providing an extremely low cost per size value.



O-RING KITS



O-RING FACE KIT

Part Number: 568 Face Kit

List Price: \$ 18.13

PART NUMBER	QTY	PART NUMBER	QTY
011-90D	25	018-90D	20
012-90D	25	021-90D	15
014-90D	25	025-90D	10
016-90D	25	029-90D	10

This kit contains a total of 155 90 Durometer O-Rings in 8 different sizes, providing an extremely low cost per size value.

O-RING FLANGE KIT

Part Number: 568 Flange Kit

List Price: \$ 21.50

PART NUMBER	QTY	PART NUMBER	QTY
210-90D	10	225-90D	10
214-90D	10	228-90D	10
219-90D	10	232-90D	10
222-90D	10		

This kit contains a total of 70, 90 Durometer O-Rings, in 7 different sizes, providing an extremely low cost per size value.



SPLIT FLANGE SEAL KIT

Part Number: SFS Kit

List Price: \$ 78.39

PART NUMBER	QTY	PART NUMBER	QTY
SFS-8	5	SFS-24	5
SFS-12	5	SFS-32	5
SFS-16	5	SFS-40	5
SFS-20	5		

This kit contains 35 Split Flange Seals in 7 popular sizes.



O-RING KITS

HOSE END & ADAPTER KIT

Part Number: O-R Fitting Kit

List Price: \$ 77.17

This handy kit contains 27 sizes and 216 pieces of 90A Durometer O-rings for boss, split flange and flat face hose end fittings and adapters. Each box has a graphic label identifying the type of application and dash number for the seal. A chart on the back of the box lists popular OEM part number matches for each O-ring. Due to popular demand, these kits are now available individually.



SAE FLANGE SEALS

Part Number: SAE Flange Seals

List Price: \$ 19.29

BOX PART NUMBER	PART NUMBER	QTY
-8	568-210-90D	8
-12	568-214-90D	8
-16	568-219-90D	8
-20	568-222-90D	8
-24	568-225-90D	8
-32	568-228-90D	8

FLAT FACE SEALS

Part Number: Flat Face O-Rings

List Price: \$ 19.29

BOX PART NUMBER	PART NUMBER	QTY
-6	568-012-90D	8
-8	568-014-90D	8
-10	568-016-90D	8
-12	568-018-90D	8
-16	568-021-90D	8
-20	568-025-90D	8
-24	568-029-90D	8

BOSS & TUBE SEALS

Part Number: Boss & Tube Fittings-1

List Price: \$ 19.29

Part Number: Boss & Tube Fittings-2

List Price: \$ 19.29

BOX PART NUMBER	PART NUMBER	QTY	BOX PART NUMBER	PART NUMBER	QTY
-2	568-902	8	-12	568-912	8
-3	568-903	8	-14	568-914	8
-4	568-904	8	-16	568-916	8
-5	568-905	8	-20	568-920	8
-6	568-906	8	-24	568-924	8
-8	568-908	8	-32	568-932	8
-10	568-910	8			

O-RING KITS

COMMON JAPANESE SIZES O-RINGS IN 70 DUROMETER

Part Number: Metric O Kit-J

List Price: \$ 40.82



This 380 piece kit contains the most popular Japanese Industrial metric O-ring sizes.

I.D.	C.S	QTY	I.D.	C.S	QTY
2.8	1.9	25	20.8	2.4	8
3.8	1.9	20	21.8	2.4	8
4.8	1.9	20	24.4	3.1	6
5.8	1.9	20	29.4	3.1	7
6.8	1.9	15	21.7	3.5	5
7.8	1.9	15	22.1	3.5	5
8.8	1.9	15	23.7	3.5	7
9.8	1.9	15	24.7	3.5	7
9.8	2.4	15	25.2	3.5	7
10.8	2.4	15	25.7	3.5	7
11.0	2.4	15	27.7	3.5	7
11.8	2.4	12	28.7	3.5	6
12.8	2.4	12	29.2	3.5	6
13.8	2.4	12	29.7	3.5	6
14.8	2.4	12	30.7	3.5	6
15.8	2.4	12	31.2	3.5	6
17.8	2.4	8	14.5	4.0	4
19.8	2.4	8	23.5	4.0	6

COMMON JAPANESE SIZES O-RINGS IN 90 DUROMETER

Part Number: Metric O Kit-J-90D

List Price: \$ 60.63



This 380 piece kit contains the most popular Japanese Industrial metric O-ring sizes in 90 durometer NBR.

I.D.	C.S	QTY	I.D.	C.S	QTY
2.8	1.9	25	20.8	2.4	8
3.8	1.9	20	21.8	2.4	8
4.8	1.9	20	24.4	3.1	6
5.8	1.9	20	29.4	3.1	7
6.8	1.9	15	21.7	3.5	5
7.8	1.9	15	22.1	3.5	5
8.8	1.9	15	23.7	3.5	7
9.8	1.9	15	24.7	3.5	7
9.8	2.4	15	25.2	3.5	7
10.8	2.4	15	25.7	3.5	7
11.0	2.4	15	27.7	3.5	7
11.8	2.4	12	28.7	3.5	6
12.8	2.4	12	29.2	3.5	6
13.8	2.4	12	29.7	3.5	6
14.8	2.4	12	30.7	3.5	6
15.8	2.4	12	31.2	3.5	6
17.8	2.4	8	14.5	4.0	4
19.8	2.4	8	23.5	4.0	6

O-RING KITS

COMMON EUROPEAN SIZES O-RINGS IN 70 DUROMETER

Part Number: Metric O Kit-E

List Price: \$ 39.19



This 500 piece kit contains the most popular European metric O-ring sizes.

I.D.	C.S.	QTY	I.D.	C.S.	QTY
5.0	1.5	20	19.0	2.0	10
13.0	1.5	15	20.0	2.0	10
16.0	1.5	10	4.3	2.4	15
2.2	1.6	20	5.3	2.4	15
3.1	1.6	20	5.6	2.4	15
4.1	1.6	20	7.6	2.4	15
7.1	1.6	20	8.3	2.4	15
9.1	1.6	15	8.6	2.4	15
10.1	1.6	15	10.0	2.5	10
13.1	1.6	15	13.0	2.5	10
4.0	2.0	20	14.0	2.5	10
6.0	2.0	20	15.0	2.5	10
8.0	2.0	15	17.0	2.5	10
9.0	2.0	15	18.0	2.5	10
10.0	2.0	15	19.0	2.5	10
12.0	2.0	15	9.0	3.0	10
14.0	2.0	10	10.0	3.0	10
16.0	2.0	10	11.0	3.0	10

COMMON EUROPEAN SIZES O-RINGS IN 90 DUROMETER

Part Number: Metric O Kit-E-90D

List Price: \$ 60.63



This 500 piece kit contains the most popular European metric O-ring sizes.

I.D.	C.S.	QTY	I.D.	C.S.	QTY
5.0	1.5	20	19.0	2.0	10
13.0	1.5	15	20.0	2.0	10
16.0	1.5	10	4.3	2.4	15
2.2	1.6	20	5.3	2.4	15
3.1	1.6	20	5.6	2.4	15
4.1	1.6	20	7.6	2.4	15
7.1	1.6	20	8.3	2.4	15
9.1	1.6	15	8.6	2.4	15
10.1	1.6	15	10.0	2.5	10
13.1	1.6	15	13.0	2.5	10
4.0	2.0	20	14.0	2.5	10
6.0	2.0	20	15.0	2.5	10
8.0	2.0	15	17.0	2.5	10
9.0	2.0	15	18.0	2.5	10
10.0	2.0	15	19.0	2.5	10
12.0	2.0	15	9.0	3.0	10
14.0	2.0	10	10.0	3.0	10
16.0	2.0	10	11.0	3.0	10

O-RING SPLICE KITS

O-RING SPLICE KIT INCH SIZES

Part Number: 568 Splice Kit
List Price: \$ 38.58

Kit Contains:

1. Stock of 70 Durometer Buna O-ring Cord
2. Razor Blade
3. Splicing tool
4. Tube of Adhesive

Replacement Parts

Parts:	List Price
#568 Splice Tool	\$9.44 ea
#568 Adhesive	\$3.68 ea
70 Duro. Cord	



O-RING SPLICE KIT INCH & METRIC SIZES

Part Number: Met/Inch Splice Kit
List Price: \$ 56.34

This kit can produce O-Rings of any standard inch size cross-section plus a wide variety of metric sizes. Each kit contains quick drying adhesive, cutting and splicing jig, razor blade and 14 lengths of 70 Durometer Buna-N cord stock as follows:

Inch cross-sections: (inch)

1/16" (.070), 3/32" (.103), 1/8" (.139),
3/16" (.210), 1/4" (.275)

Metric cross-sections: (mm)

1.5, 2.0, 2.5, 3.0, 3.5, 4.0, 5.0, 5.7, 8.4



These kits can produce O-Rings of any circumference. The 568 kit contains the most popular inch cross sectional sized O-ring cord. The Metric and Inch Kit has both standard inch size cross sectional cord plus a wide variety of metric sized cord. Both kits contain quick drying adhesive, a cutting and splicing jig, a razor blade and 70 Durometer Buna-N cord.

FLUOROCARBON O-RING SPLICE KIT INCH SIZES

Part Number: 568 FC Splice Kit
List Price: \$ 153.72

Kit Contains:

1. Stock of 75 Durometer Fluorocarbon Cord
2. Razor Blade
3. Splicing tool
4. Tube of Adhesive

Replacement Parts

Parts:	List Price
#568 Splice Tool	\$9.44 ea
#568 Adhesive	\$3.68 ea
75 Duro. Fluorocarbon Cord	



BACK-UP RING KITS

574 BACK-UP RING KIT

Part Number: 574 Kit
List Price: \$ 61.24

PART NUMBER	QTY	PART NUMBER	QTY
574-005	10	574-114	10
574-006	10	574-115	10
574-007	10	574-116	10
574-008	10	574-117	5
574-009	10	574-118	5
574-010	10	574-119	5
574-011	10	574-120	5
574-012	10	574-121	5
574-013	10	574-210	7
574-014	10	574-211	7
574-015	10	574-212	7
574-016	10	574-213	7
574-017	10	574-214	5
574-018	10	574-215	5
574-110	10	574-216	5
574-111	10	574-217	5
574-112	10	574-218	5
574-113	10	574-219	5



This 293 piece kit contains 36 of the most popular size "Parback®" Style Dished Cross Section back-up rings. Molded of 90A Durometer Buna-N Rubber, they stretch for installation and return quickly to their original size. SIZES CORRESPOND TO O-RING NUMBERS. Your shop and service truck should not be without this handy kit.

575 BACK-UP RING KIT

Part Number: 575 Kit
List Price: \$ 133.17

PART NUMBER	QTY	PART NUMBER	QTY
575-111	25	575-216	25
575-112	25	575-217	15
575-113	25	575-218	15
575-114	25	575-219	15
575-115	25	575-220	15
575-116	25	575-221	15
575-210	25	575-222	15
575-211	25	575-223	15
575-212	25	575-224	15
575-213	25	575-325	10
575-214	25	575-326	10
575-215	25	575-327	10



This 475 piece kit contains 24 of the most popular size Urethane Back-up Rings. This assortment is essential for parts counters, shop use, and service trucks.

BACK-UP RING KITS

PTFE BACK-UP RING KIT

Part Number: 575 PTFE Kit S

List Price: \$ 139.63

PART NUMBER	QTY	PART NUMBER	QTY
575-005ST	15	575-114ST	10
575-006ST	15	575-115ST	10
575-007ST	15	575-116ST	10
575-008ST	15	575-117ST	5
575-009ST	15	575-118ST	5
575-010ST	15	575-119ST	5
575-011ST	15	575-120ST	5
575-012ST	15	575-121ST	5
575-013ST	10	575-210ST	5
575-014ST	10	575-211ST	5
575-015ST	10	575-212ST	5
575-016ST	10	575-213ST	5
575-017ST	10	575-214ST	5
575-018ST	10	575-215ST	5
575-110ST	10	575-216ST	5
575-111ST	10	575-217ST	5
575-112ST	10	575-218ST	5
575-113ST	10	575-219ST	5

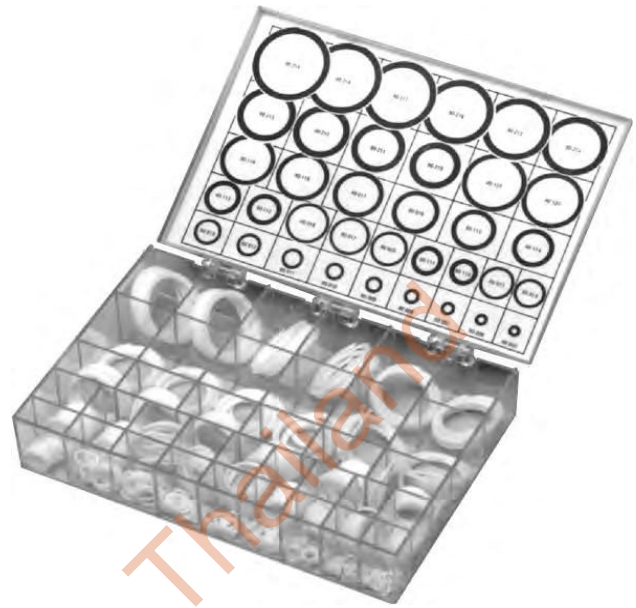

This 325 piece kit contains 36 of the most popular size PTFE Back-up Rings. These rings are compatible with all hydraulic fluids, since they are virtually chemically inert, and can be used in applications involving elevated operating temperatures. These rings are scarf cut to facilitate installation.

STYLE 870 KIT

Part Number: 870 TRI-Kit

List Price: \$ 165.36

Our 870 Tri-Kit is packaged in three sturdy cases that contain 180 U-Cups. The U-Cups conform to AN-6226 size standards in 36 popular sizes ranging from 1/8" to 1-1/8" inside diameter. All of the seals are molded from 70A Durometer Buna-N rubber.



RETAINER RING KITS

Each kit has an assortment of retainer rings (Tru-arc, Eaton, or spiral wound style) packed in a reusable plastic box. All rings are made in the USA from carbon spring steel.

Each kit contains: 18 sizes - 9 internal, 9 external • 216 rings per box • 12 rings per size

TRU-ARC

Part Number: 300-310 Kit

List Price: \$ 97.01

PART NUMBER	QTY.	PART NUMBER	QTY.
300-050	12	310-050	12
300-062	12	310-062	12
300-075	12	310-075	12
300-087	12	310-087	12
300-100	12	310-100	12
300-112	12	310-112	12
300-125	12	310-125	12
300-137	12	310-137	12
300-150	12	310-150	12



SPIRAL WOUND

Part Number: SRR Kit

List Price: \$ 176.38

PART NUMBER	QTY.	PART NUMBER	QTY.
WHM-050	12	WSM-050	12
WHM-062	12	WSM-062	12
WHM-075	12	WSM-075	12
WHM-087	12	WSM-087	12
WHM-100	12	WSM-100	12
WHM-112	12	WSM-112	12
WHM-125	12	WSM-125	12
WHM-137	12	WSM-137	12
WHM-150	12	WSM-150	12



EATON

Part Number: ERR Kit

List Price: \$ 220.48

PART NUMBER	QTY.	PART NUMBER	QTY.
NAN-050	12	XAN-050	12
NAN-062	12	XAN-062	12
NAN-075	12	XAN-075	12
NAN-087	12	XAN-087	12
NAN-100	12	XAN-100	12
NAN-112	12	XAN-112	12
NAN-125	12	XAN-125	12
NAN-137	12	XAN-137	12
NAN-150	12	XAN-150	12



RETAINER RING KITS

ROTOR PACK KIT

Part Number: RPK 4 Kit
List Price: \$ 187.41

Packaged in four plastic cases with a handy carrying case, our rotor pack kit contains approximately 50 each of 20 common internal/external retaining ring sizes. The internal rings fit housings or bores from 3/8" internal diameter to 1-1/8". External rings accommodate shaft sizes from 1/4" internal diameter to 1-1/8". Two retainer ring installation pliers are also included.



These assortments contain the most popular size retainer rings, boxed in a handy storage and display case, which will supply your shop, service truck, or parts counter with the sizes you need!

INTERNAL RETAINER RINGS

Part Number: 300 Kit
List Price: \$ 159.21

PART NUMBER	BORE SIZE	QTY.	PART NUMBER	BORE SIZE	QTY.
300-075	0.750	10	300-200	2.000	10
300-087	0.875	10	300-225	2.250	5
300-100	1.000	10	300-250	2.500	5
300-112	1.125	10	300-275	2.750	5
300-125	1.250	10	300-300	3.000	5
300-137	1.375	10	300-350	3.500	5
300-150	1.500	10	300-400	4.000	5
300-162	1.625	10	300-450	4.500	2
300-175	1.750	10	300-500	5.000	2

EXTERNAL RETAINER RINGS

Part Number: 310 Kit
List Price: \$ 61.22

PART NUMBER	SHAFT SIZE	QTY.	PART NUMBER	SHAFT SIZE	QTY.
310-100	1.000	5	310-200	2.000	5
310-125	1.250	5	310-225	2.250	5
310-137	1.375	5	310-250	2.500	5
310-150	1.500	5	310-275	2.750	3
310-175	1.750	5	310-300	3.000	3



ASSORTMENT KITS

CAP PLUG KIT

Part Number: Cap Plug Kit
List Price: \$ 143.31



This sturdy kit, packaged in an unbreakable box, contains 553 cap plugs in the most popular sizes.

Cap Plug Number	QTY	Cap Plug Number	QTY	Cap Plug Number	QTY
CAP-2-X	50	CAP-PD-100	15	CAP-G-22	10
CAP-4	50	CAP-PD-120	10	CAP-G-25	12
CAP-6-X	50	CAP-PD-140	5	CAP-G-27	16
CAP-9	40	CAP-PD-160	10	CAP-P-28	25
CAP-12-X	25	CAP-G-2	20	CAP-P-38	25
CAP-14	20	CAP-G-8	20	CAP-P-48	25
CAP-PD-60	25	CAP-G-14	20	CAP-P-68-H	25
CAP-PD-80	25	CAP-G-18	20	CAP-P-88-H	10

CAT® SILICONE O-RING KIT

Part Number: CTC-4C8253
List Price: \$ 300.51

This handy kit, in an unbreakable box, contains 149 silicone o-rings in the 32 most popular sizes used on Caterpillar® equipment.



CAT® D-RING KIT

This handy kit, in an unbreakable box, contains the 9 most popular sized D-Rings used on Caterpillar® equipment.

Part Number: CTC-4C4784
List Price: \$ 111.57



CAT® NITRILE O-RING KIT

This handy kit, in an unbreakable box, contains 570 nitrile o-rings in the 32 most popular sizes used on Caterpillar® equipment.

Part Number: CTC-4C4782
List Price: \$ 188.50



NOTE: Caterpillar® part numbers are used as a reference only. We do not imply that these parts are original equipment parts.

ASSORTMENT KITS

COTTER PIN KIT

Part Number: Cotter Pin Kit
List Price: \$ 27.56



	1/16" X 1" 150 pcs.	3/32" X 1" 150 pcs.
	1/8" X 1 1/4" 75 pcs.	3/32" X 1 1/2" 100 pcs.
	1/8" X 2" 50 pcs.	5/32" X 2 1/2" 30 pcs.
555 Pieces		

WOODRUFF KEY KIT

Part Number: Woodruff Keys Kit
List Price: \$ 61.48



	1/8" X 1/2" No. 3 16 pcs.	1/8" X 5/8" No. 5 15 pcs.
	3/32" X 5/8" No. 6 15 pcs.	3/16" X 3/4" No. 9 10 pcs.
	1/4" X 7/8" No. A 5 pcs.	1/4" X 1" No. 15 4 pcs.
	65 Pieces	

GREASE FITTING KIT

Part Number: Grease Fitting Kit
List Price: \$ 44.10



	1/8" NPT Straight 6 pcs.	1/4" - 28 Straight 6 pcs.
	3/16" Drive Straight 4 pcs.	1/8" NPT 45 1/8" NPT 90 3 pcs. ea.
	1/4" - 28 45 1/4" - 28 90 3 pc. ea.	5/16" Drive Straight 4 pcs.
32 Pieces		



INSTALLATION TOOLS

ROD U-SEAL INSTALLATION TOOLS

Part Number: IT100, IT150, IT200
List Price: \$ 57.88 each

PART NUMBER	SEAL ID RANGE
IT 100-NN	3/4 " to 1 1/4"
IT 150-NN	1 3/8" to 1 7/8"
IT 200-NN	2" to 3"

These tools aid U-seal installation, eliminating the risk of damaging the seal lip.



PUMP & MOTOR SHAFT SEAL INSTALLATION TOOL

Part Number: CMST-100, -200
List Price: \$ 7.71 ea.

These guides protect fragile seal lips during installation. Use on all Commercial and Commercial replacement units. For small shafts use CMST-100, and for larger shafts use CMST-200.



KINGSEAL CO., LTD. THAILAND

46/152-153 Moo 3 Sri Saman Road
Baan Mai Pakkret, Nonthaburi Thailand 11120

Tel: +662 9617534 to 6

Fax: +662 9617540

Email: intlsales@kingseal.co.th / kingsealmail@gmail.com

Website: <http://www.kingseal.co.th>

REMOVAL TOOLS

We have the packing removal tools to fit your needs.
Try out these high quality tools in your shop.

Proper tools make the job of servicing cylinders easier and faster and reduce the possibility of damaging the finely machined surfaces. The handy tools listed on this page aid in the repair of telescopic cylinders and make it easier to do a quality job.

O-RING PICK SET 1

Part Number: O-Ring Pick
List Price: \$ 12.95

These Bronze O-ring Picks, w/ black vinyl case, aid in the installation and extraction of O-rings.



O-RING PICK SET 2

Part Number: ORP-B
List Price: \$ 20.14
Part Number: ORP-SS
List Price: \$ 24.25

Available in brass (ORP-B) or stainless steel (ORP-SS), these tools have been specifically engineered to enhance o-ring removal and replacement. Coated handles increase the tools performance in less than perfect environments.



O-RING PICK SET 3

Part Number: O Pick Set
List Price: \$ 28.62

Packaged in a clear vinyl pouch, kit contains a knurled handle and four screw-in picks with different hook configurations. Set includes straight tip, o-ring 90° tip, hook tip, and angle tip.



O-RING PICK SET 4

Part Number: Maxi Pick Set
List Price: \$ 71.50

Packaged in a plastic pouch, these highly visible picks feature screwdriver-type colored handles. Set includes awl, hook tip, 45° bent tip tool, and 90° bent tip tool.



REMOVAL TOOLS

**We have the packing removal tools to fit your needs.
Try out these high quality tools in your shop.**

Proper tools make the job of servicing cylinders easier and faster and reduce the possibility of damaging the finely machined surfaces. The handy tools listed on this page aid in the repair of telescopic cylinders and make it easier to do a quality job.

5 PIECE TOOL KIT SET

Part Number: CH-TK-1
List Price: \$ 154.34

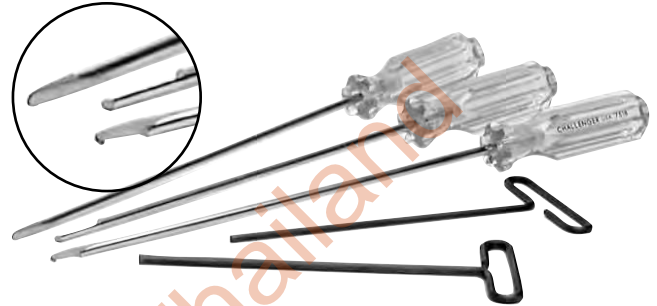

CHEVRON ASSEMBLY TOOL

Part Number: CM-376-9067-001
List Price: \$ 62.15



FLEXIBLE PACKING HOOKS

Part Number	Packing Space	Length	List Price
FPH-187	3/16"-up	6-1/2"	\$ 28.37
FPH-312R	5/16"-up	7-1/2"	20.17
FPH-437R	7/16"-up	10-1/2"	25.89
FPH-500R	1/2"-up	14-1/2"	36.59



With a tempered tool steel corkscrew tip and a woven strand steel flexible shaft, this tool makes hard to reach packing easy to pull out. Works best by using two hooks at diametrically opposed points (180°).



REMOVAL TOOLS

**We have the packing removal tools to fit your needs.
Try out these high quality tools in your shop.**

Proper tools make the job of servicing cylinders easier and faster and reduce the possibility of damaging the finely machined surfaces. The handy tools listed on this page aid in the repair of telescopic cylinders and make it easier to do a quality job.

REPLACEABLE WOODSCREW TIPS

Part Number	Packing Space	List Price
FPH-RTW312	5/16"-up	\$ 13.44
FPH-RTW437	7/16"-up	15.32
FPH-RTW500	1/2"-up	16.86



REPLACEABLE CORKSCREW TIPS

Part Number	Packing Space	List Price
FPH-RTC312	5/16"-up	\$ 9.11
FPH-RTC437	7/16"-up	11.02
FPH-RTC500	1/2"-up	14.58

SOLID SHAFT PICKS

Part Number	Packing Space	Length	List Price
SSP-125		9-1/2"	\$ 15.53
SSP-187	3/16"-up	9-1/2"	17.15
SSP-312	5/16"-up	10"	26.46

Formed from hardened steel, this tool's length and sharp angled point gets at hard to reach o-rings, back-up rings & braided packing. You'll be amazed at all the uses you find for this tool.



REMOVAL TOOLS

**We have the packing removal tools to fit your needs.
Try out these high quality tools in your shop.**

Proper tools make the job of servicing cylinders easier and faster and reduce the possibility of damaging the finely machined surfaces. The handy tools listed on this page aid in the repair of telescopic cylinders and make it easier to do a quality job.

11 PIECE PACKING TOOL KIT

Part Number: Pack Tool Set-11
List Price: \$ 150.04

PART NUMBER	QTY	PART NUMBER	QTY
FPH-312R	2	FPH-RTC312	1
FPH-437R	2	FPH-RTC437	1
SSP-125	1	WRENCH	1
SSP-187	1	BOX	1
SSP-312	1		



17 PIECE PACKING TOOL KIT

Part Number: Pack Tool Set-17
List Price: \$ 258.45



PART NUMBER	QTY	PART NUMBER	QTY
FPH-312R	2	FPH-RTC437	1
FPH-437R	2	FPH-RTC500	1
FPH-500R	2	FPH-RTW312	1
SSP-125	1	FPH-RTW437	1
SSP-187	1	FPH-RTW500	1
SSP-312	1	WRENCH	1
FPH-RTC312	1	BOX	1

With a tempered tool steel corkscrew tip and a woven strand steel flexible shaft, this tool makes hard to reach packing easy to pull out. Works best by using two hooks at diametrically opposed points (180°).

MEASURING TOOLS

O-RING MEASURING CONE

Part Number: O Ring Cone-Inch
List Price: \$ 143.31

Handy cone provides o-ring dash numbers instantly. Measures 184 of the most widely used sizes in 5 standard widths, 1/4" ID to 5-5/8" ID. Made of high density polyurethane, the cone stands 17-1/2" high.



DIGITAL CALIPERS



Part Number	List Price
HH-Caliper-6-P	\$ 76.56
HH-Caliper-12-P	165.36

A high quality instrument, able to measure up to 150mm or 6". A push of a button changes from inches to metric. A clear LCD display shows a reading with a resolution of 0.0005" (0.01mm) that is accurate to ± 0.03 mm. These calipers come in a sturdy, padded plastic case with instructions and a spare battery.

PI TAPES

Part Number	Size	List Price
PI-212	2" - 12"	\$ 185.20

This handy tool allows for quick accurate measuring of the outside diameters (OD) of vee packing, large U-Seals, Piston Rings, and metal parts such as cylinder stages, rams and rods. This tape comes with certificate of calibration. Accurate to .001".



MEASURING TOOLS

O-RING CHART



Part Number: O-Ring Chart NN
List Price: \$ 36.38

Durable, Accurate, and Fast, these charts allow for easy Standard O-ring size identification. No shop should be without one!

POWER PUNCH MAXI SET

Part Number: Maxi Punch Set
List Price: \$ 254.65

PART NUMBER	PUNCH RANGE
Punch Set	1/4, 5/16, 3/8, 7/16, 1/2, 16,5/8, 1/16, 3/4, 3/16, 7/8, 5/16, 1

This extremely high quality punch set includes 13 punches, power punch, centering pin, punch pad and carrying case. Durable cutting heads cut washers and bolt holes effortlessly. Guaranteed 100% satisfaction.



NOTES

Kingseal Co., Ltd. Thailand



KINGSEAL CO., LTD. THAILAND

46/152-153 Moo 3 Sri Saman Road
Baan Mai Pakkret, Nonthaburi Thailand 11120

Tel: +662 9617534 to 6

Fax: +662 9617540

Email: intlsales@kingseal.co.th / kingsealmail@gmail.com

Website: <http://www.kingseal.co.th>

Appendix

Contents	Page
Metric / Inch Conversion Table	532 - 533
Common Telescopic Cylinders - Distinguishing Characteristics	534 - 543



KINGSEAL CO., LTD. THAILAND

46/152-153 Moo 3 Sri Saman Road
Baan Mai Pakkret, Nonthaburi Thailand 11120

Tel: +662 9617534 to 6

Fax: +662 9617540

Email: intlsales@kingseal.co.th / kingsealmail@gmail.com

Website: <http://www.kingseal.co.th>

Inches		Millimeter
Fractions	Decimals	
—	.0004	.01
—	.004	.10
—	.01	.25
1/64	.0156	.397
—	.0197	.50
—	.0295	.75
1/32	.03125	.794
—	.0394	1.0
3/64	.0469	1.191
—	.059	1.5
1/16	.062	1.588
5/64	.0781	1.984
—	.0787	2.0
3/32	.094	2.381
—	.0984	2.5
7/64	.109	2.778
—	.1181	3.0
1/8	.125	3.175
—	.1378	3.5
9/64	.141	3.572
5/32	.156	3.969
—	.1575	4.0
11/64	.172	4.366
—	.177	4.5
3/16	.1875	4.763
—	.1969	5.0
13/64	.203	5.159
—	.2165	5.5
7/32	.219	5.556
15/64	.234	5.953
—	.2362	6.0
1/4	.250	6.350
—	.2559	6.5
17/64	.2656	6.747
—	.2756	7.0
9/32	.281	7.144
—	.2953	7.5
19/64	.297	7.541
5/16	.312	7.938
—	.315	8.0
21/64	.328	8.334
—	.335	8.5
11/32	.344	8.731
—	.3543	9.0
23/64	.359	9.128

Inches		Millimeter
Fractions	Decimals	
—	.374	9.5
3/8	.375	9.525
25/64	.391	9.922
—	.3937	10.0
13/32	.406	10.319
—	.413	10.5
27/64	.422	10.716
—	.4331	11.0
7/16	.438	11.113
29/64	.453	11.509
15/32	.469	11.906
—	.4724	12.0
31/64	.484	12.303
—	.492	12.5
1/2	.500	12.700
—	.5118	13.0
33/64	.5156	13.097
17/32	.531	13.494
35/64	.547	13.891
—	.5512	14.0
9/16	.563	14.288
—	.571	14.5
37/64	.578	14.684
—	.5906	15.0
19/32	.594	15.081
39/64	.609	15.478
5/8	.625	15.875
—	.6299	16.0
41/64	.6406	16.272
—	.6496	16.5
21/32	.658	16.669
—	.6693	17.0
43/64	.672	17.066
11/16	.6875	17.463
45/64	.703	17.859
—	.7087	18.0
23/32	.719	18.256
—	.7283	18.5
47/64	.734	18.653
—	.7480	19.0
3/4	.750	19.050
49/64	.7656	19.447
25/32	.781	19.844
—	.7874	20.0
51/64	.797	20.241

Inches		Millimeter
Fractions	Decimals	
13/16	.8125	20.638
—	.8268	21.0
53/64	.828	21.034
27/32	.844	21.431
55/64	.859	21.828
—	.8661	22.0
7/8	.875	22.225
57/64	.8906	22.622
—	.9055	23.0
29/32	.9062	23.019
59/64	.922	23.416
15/16	.9375	23.813
—	.9449	24.0
61/64	.953	24.209
31/32	.969	24.606
—	.9843	25.0
63/64	.9844	25.003
1	1.000	25.400
—	1.0236	26.0
1-1/32	1.0312	26.194
1-1/16	1.062	26.988
—	1.063	27.0
1-3/32	1.094	27.781
—	1.1024	28.0
1-1/8	1.125	28.575
—	1.1417	29.0
1-5/32	1.156	29.369
—	1.1811	30.0
1-3/16	1.1875	30.163
1-7/32	1.219	30.956
—	1.2205	31.0
1-1/4	1.250	31.750
—	1.2598	32.0
1-9/32	1.281	32.544
—	1.2992	33.0
1-5/16	1.312	33.338
—	1.3386	34.0
1-11/32	1.344	34.131
1-3/8	1.375	34.925
—	1.3779	35.0
1-13/32	1.406	35.719
—	1.4173	36.0
1-7/16	1.438	36.513
—	1.4567	37.0
1-15/32	1.469	37.306

Inches		Millimeter
Fractions	Decimals	
—	1.4961	38.0
1-1/2	1.500	38.100
1-17/32	1.531	38.894
—	1.5354	39.0
1-9/16	1.562	39.688
—	1.5748	40.0
1-19/32	1.594	40.481
—	1.6142	41.0
1-5/8	1.625	41.275
—	1.6535	42.0
1-21/32	1.6562	42.069
1-11/16	1.6875	42.863
—	1.6929	43.0
1-23/32	1.719	43.656
—	1.7323	44.0
1-3/4	1.750	44.450
—	1.7717	45.0
1-25/32	1.781	45.244
—	1.8110	46.0
1-13/16	1.8125	46.038
1-27/32	1.844	46.831
—	1.8504	47.0
1-7/8	1.875	47.625
—	1.8898	48.0
1-29/32	1.9062	48.419
—	1.9291	49.0
1-15/16	1.9375	49.213
—	1.9685	50.0
1-31/32	1.969	50.006
2	2.000	50.800
—	2.0079	51.0
2-1/32	2.03125	51.594
—	2.0472	52.0
2-1/6	2.062	52.388
—	2.0866	53.0
2-3/32	2.094	53.181
2-1/8	2.125	53.975
—	2.126	54.0
2-5/32	2.156	54.769
—	2.165	55.0
2-3/16	2.1875	55.563
—	2.2047	56.0
2-7/32	2.219	56.356
—	2.244	57.0
2-1/4	2.250	57.150

Inches		Millimeter
Fractions	Decimals	
2-9/32	2.281	57.944
—	2.2835	58.0
2-5/16	2.312	58.738
—	2.3228	59.0
2-11/32	2.344	59.531
—	2.3622	60.0
2-3/8	2.375	60.325
—	2.4016	61.0
2-13/32	2.406	61.119
2-7/16	2.438	61.913
—	2.4409	62.0
2-15/32	2.469	62.706
—	2.4803	63.0
2-1/2	2.500	63.500
—	2.5197	64.0
2-17/32	2.531	64.294
—	2.559	65.0
2-9/16	2.562	65.088
2-19/32	2.594	65.881
—	2.5984	66.0
2-5/8	2.625	66.675
—	2.638	67.0
2-21/32	2.656	67.469
—	2.6772	68.0
2-11/16	2.6875	68.263
—	2.7165	69.0
2-23/32	2.719	69.056
2-3/4	2.750	69.850
—	2.7559	70.0
2-25/32	2.781	70.6439
—	2.7953	71.0
2-13/16	2.8125	71.4376
—	2.8346	72.0
2-27/32	2.844	72.2314
—	2.8740	73.0
2-7/8	2.875	73.025
2-29/32	2.9062	73.819
—	2.9134	74.0
2-15/16	2.9375	74.613
—	2.9527	75.0
2-31/32	2.969	75.406
—	2.9921	76.0
3	3.000	76.200
3-1/32	3.0312	76.994
—	3.0315	77.0

Inches		Millimeter
Fractions	Decimals	
3-1/16	3.062	77.788
—	3.0709	78.0
3-3/32	3.094	78.581
—	3.1102	79.0
3-1/8	3.125	79.581
—	3.1496	80.0
3-5/32	3.156	80.169
3-3/16	3.1875	80.963
—	3.1890	81.0
3-7/32	3.219	81.756
—	3.2283	82.0
3-1/4	3.250	82.550
—	3.2677	83.0
3-9/32	3.281	83.344
—	3.3071	84.0
3-5/16	3.312	84.1377
3-11/32	3.344	84.9314
—	3.3464	85.0
3-3/8	3.375	85.725
—	3.3858	86.0
3-13/32	3.406	86.519
—	3.4252	87.0
3-7/16	3.438	87.313
—	3.4648	88.0
3-15/32	3.469	88.108
3-1/2	3.500	88.900
—	3.5039	89.0
3-17/32	3.531	89.694
—	3.5433	90.0
3-9/16	3.562	90.4877
—	3.5827	91.0
3-19/32	3.594	91.281
—	3.622	92.0
3-5/8	3.625	92.075
3-21/32	3.656	92.869
—	3.6614	93.0
3-11/16	3.6875	93.663
—	3.7008	94.0
3-23/32	3.719	94.456
—	3.7401	95.0
3-3/4	3.750	95.250
—	3.7795	96.0
3-25/32	3.781	96.044
3-13/16	3.8125	96.838
—	3.8189	97.0

Inches		Millimeter
Fractions	Decimals	
3-27/32	3.844	97.631
—	3.8583	98.0
3-7/8	3.875	98.425
—	3.8976	99.0
3-29/32	3.9062	99.219
—	3.9370	100.0
3-15/16	3.9375	100.013
3-31/32	3.969	100.806
—	3.9764	101.0
4	4.000	101.600
4-1/16	4.062	103.188
4-1/8	4.125	104.775
—	4.1338	105.0
4-3/16	4.1875	106.363
4-1/4	4.250	107.950
4-5/16	4.312	109.538
—	4.3307	110.0
4-3/8	4.375	111.125
4-7/16	4.438	112.713
4-1/2	4.500	114.300
—	4.5275	115.0
4-9/16	4.562	115.888
4-5/8	4.625	117.475
4-11/16	4.6875	119.063
—	4.7244	120.0
4-3/4	4.750	120.650
4-13/16	4.8125	122.238
4-7/8	4.875	123.825
—	4.9212	125.0
4-15/16	4.9375	125.413
5	5.000	127.000
—	5.1181	130.0
5-1/4	5.250	133.350
5-1/2	5.500	139.700
—	5.5118	140.0
5-3/4	5.750	146.050
—	5.9055	150.0
6	6.000	152.400
6-1/4	6.250	158.750
—	6.2992	160.0
6-1/2	6.500	165.100
—	6.6929	170.0
6-3/4	6.750	171.450
7	7.000	177.800
—	7.0866	180.0

Inches		Millimeter
Fractions	Decimals	
—	7.4803	190.0
7-1/2	7.500	190.500
—	7.8740	200.0
8	8.000	203.200
—	8.2677	210.0
8-1/2	8.500	215.900
—	8.6614	220.0
9	9.000	228.600
—	9.0551	230.0
—	9.4488	240.0
9-1/2	9.500	241.300
—	9.8425	250.0
10	10.000	254.001
—	10.2362	260.0
—	10.6299	270.0
11	11.000	279.401
—	11.0236	280.0
—	11.4173	290.0
—	11.8110	300.0
12	12.000	304.801
13	13.000	330.201
—	13.7795	350.0
14	14.000	355.601
15	15.000	381.001
—	15.7480	400.0
16	16.000	406.401
17	17.000	431.801
—	17.7165	450.0
18	18.000	457.201
19	19.000	482.601
—	19.6850	500.0
20	20.000	508.001



ANTHONY

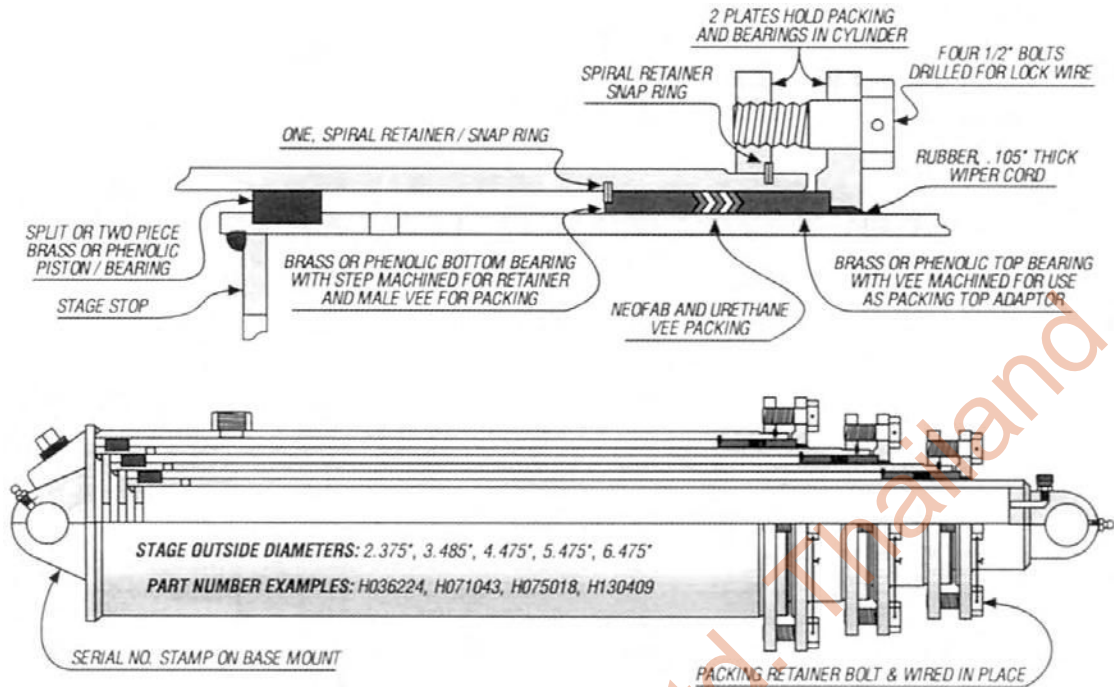

COMMERCIAL

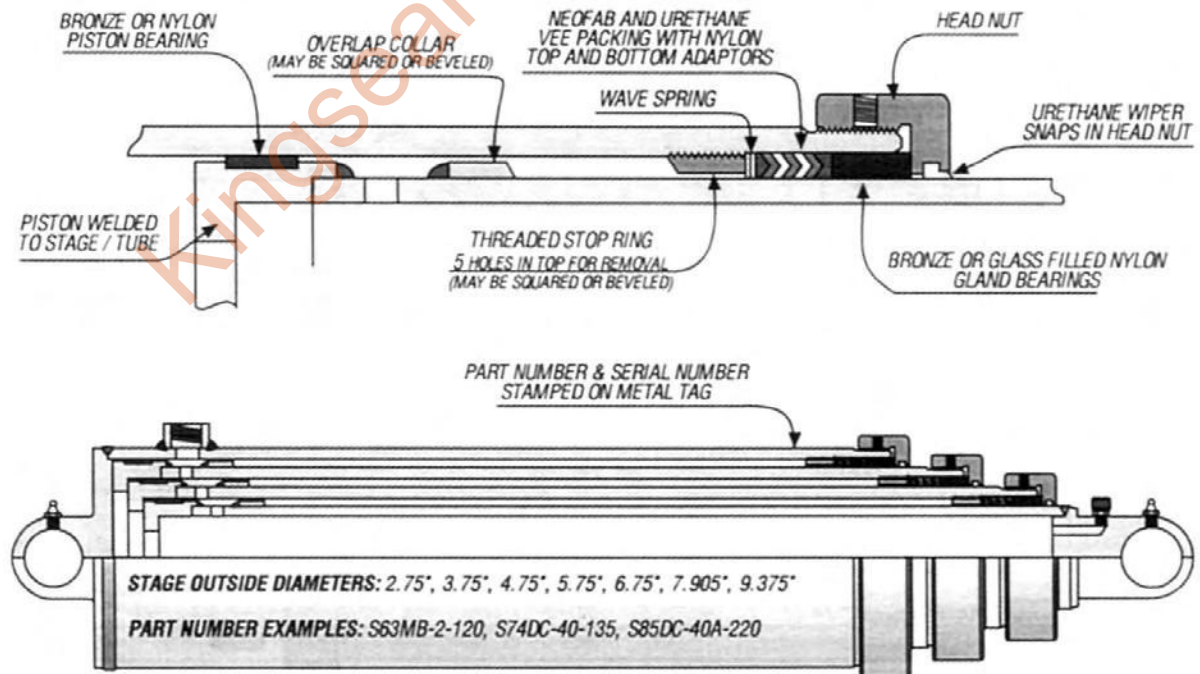

CUSTOM HOISTS 400 SERIES

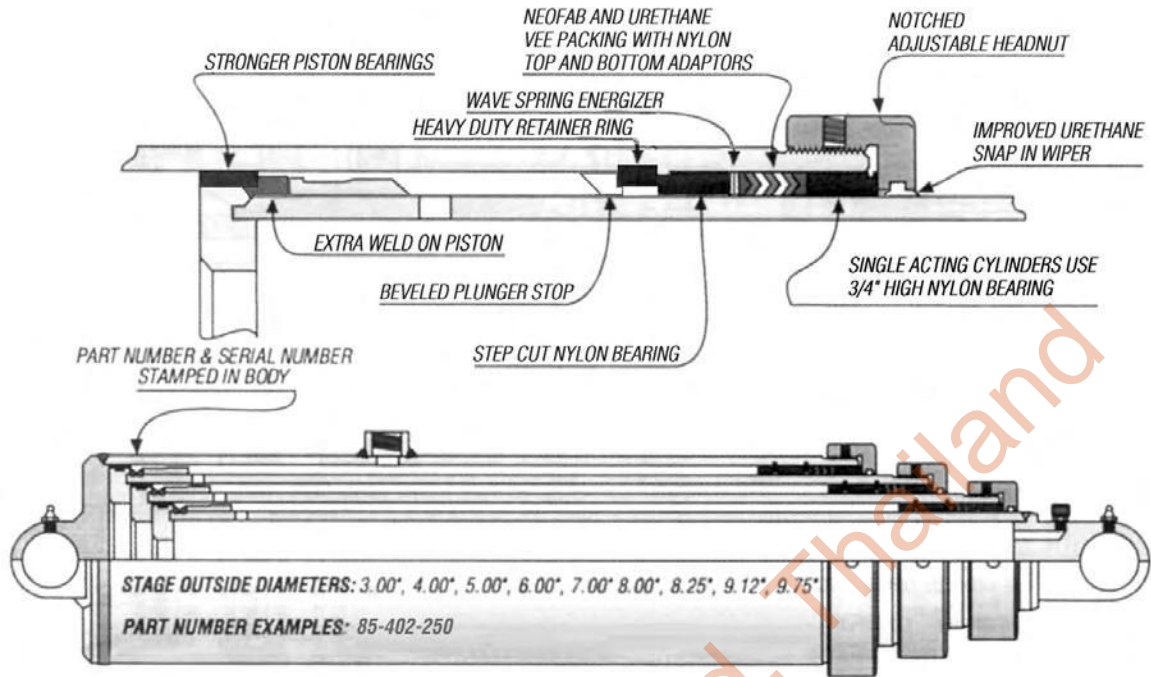

CUSTOM HOISTS OLD SERIES

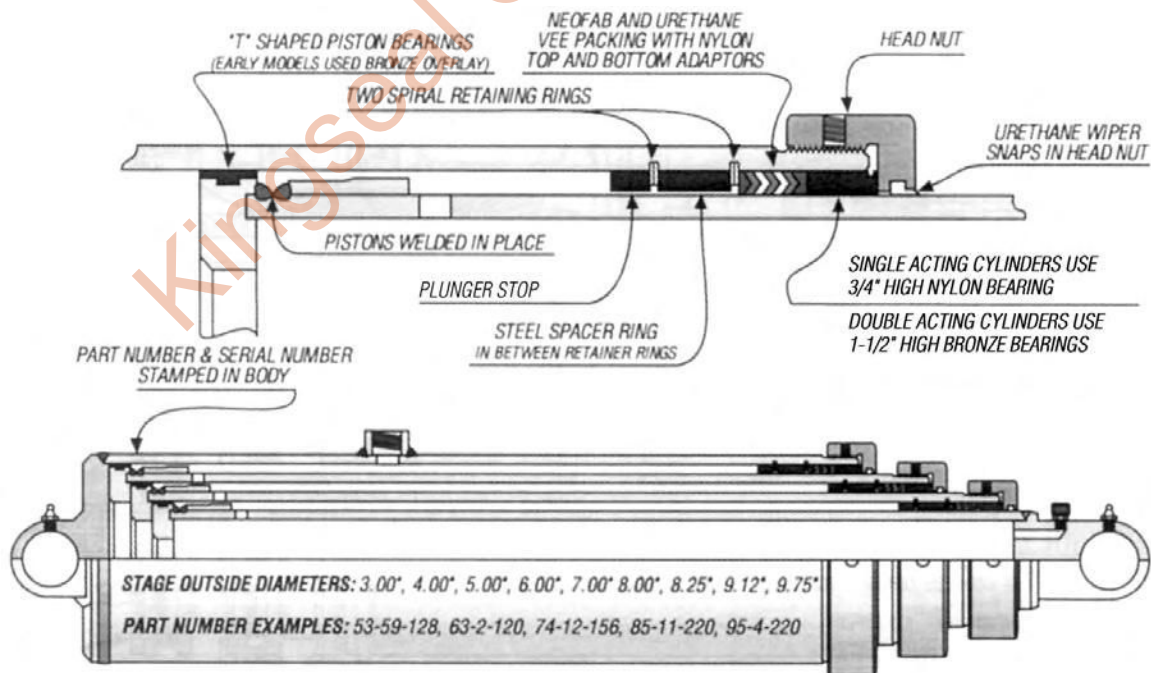

FONTAINE

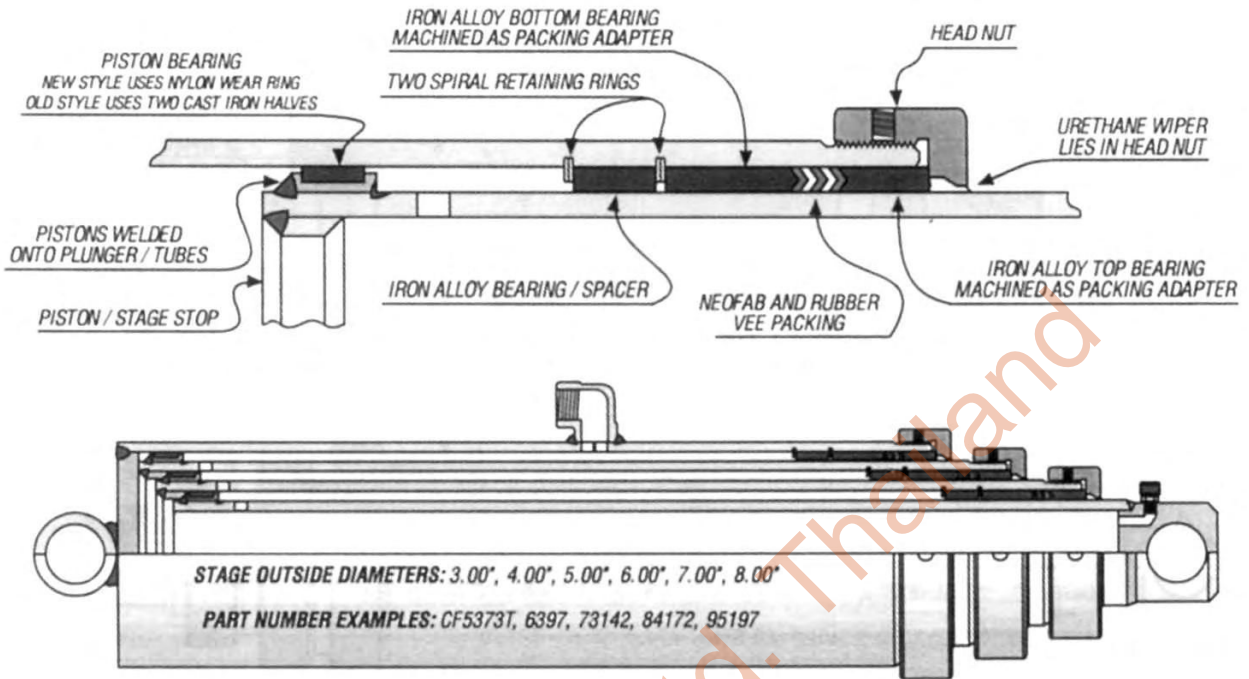

GLENCO / FARMHAND

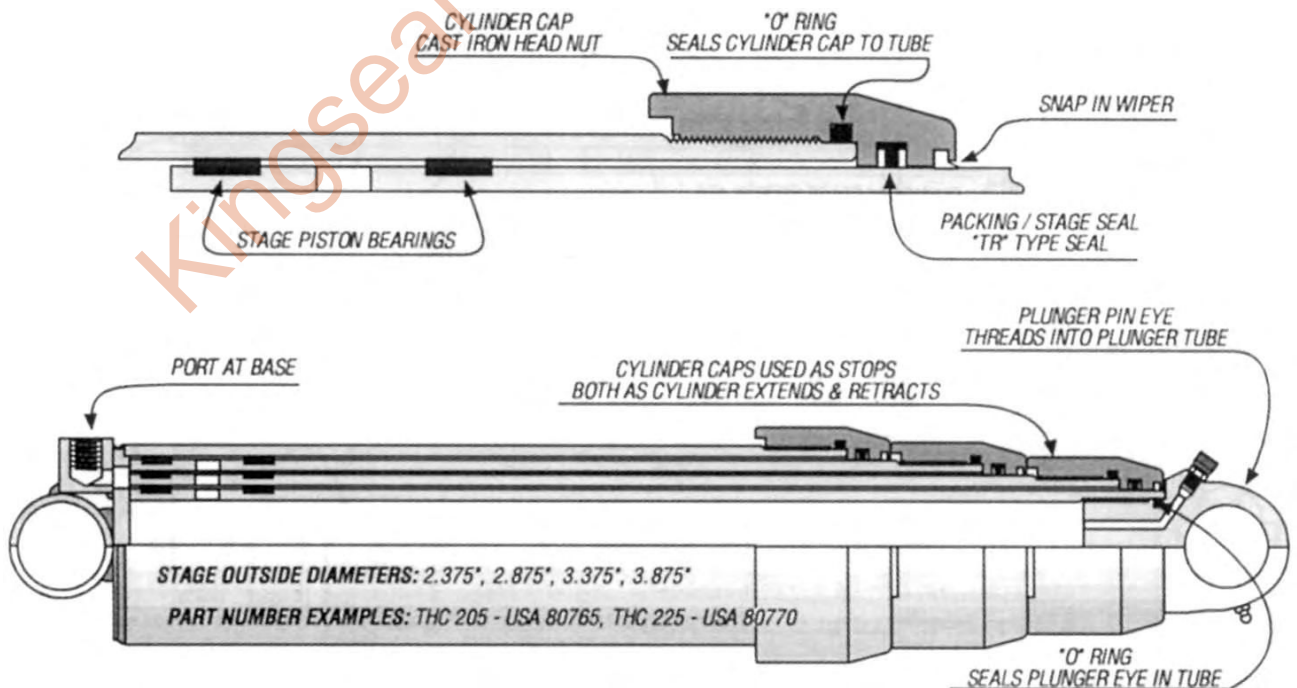

HEIL "OLD STYLE" HPT SERIES

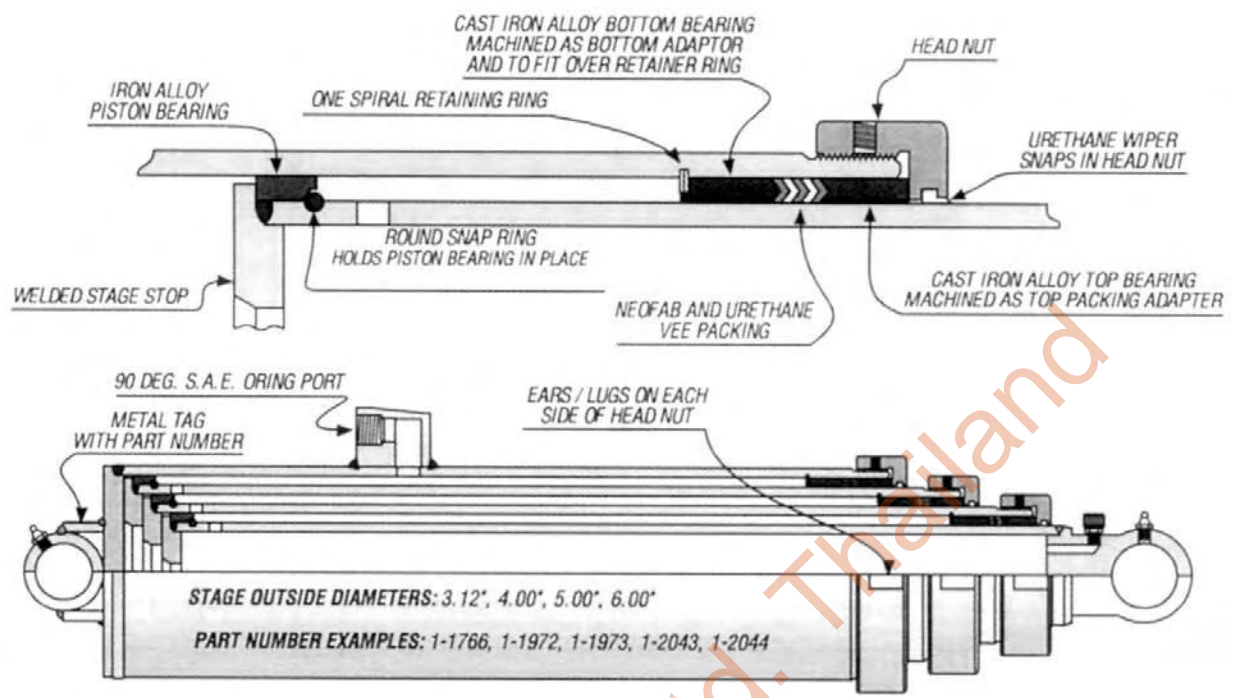

HEIL "NEW STYLE" HPT SERIES

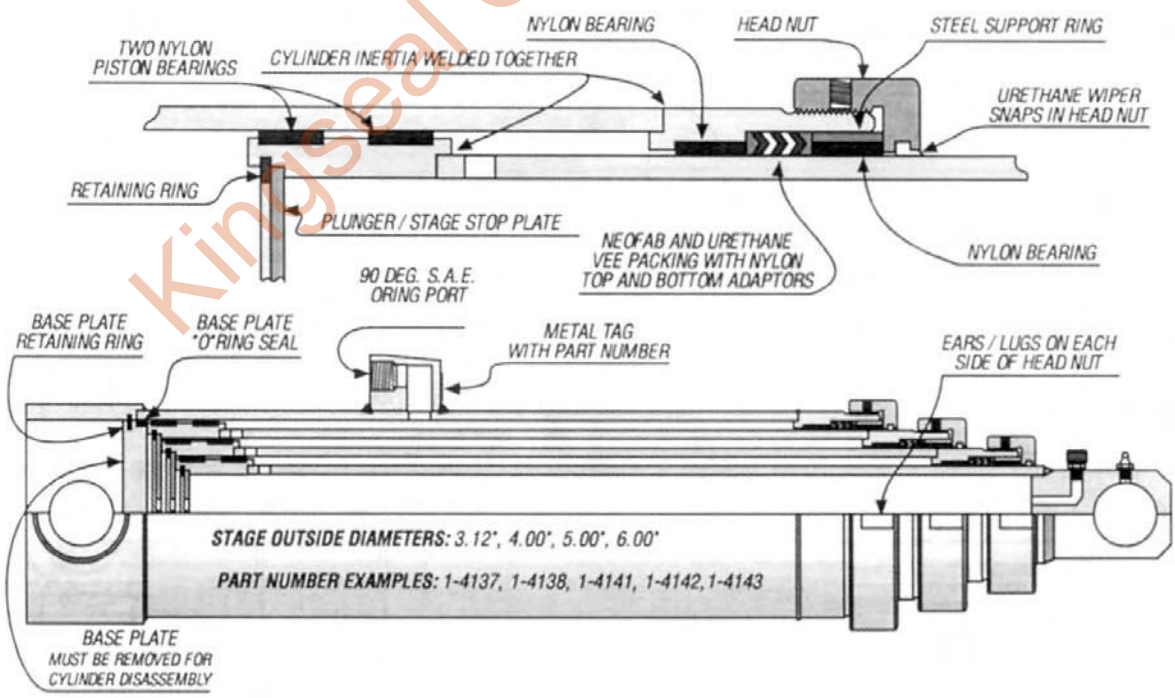

HEIL "NEW STYLE" HPT SERIES

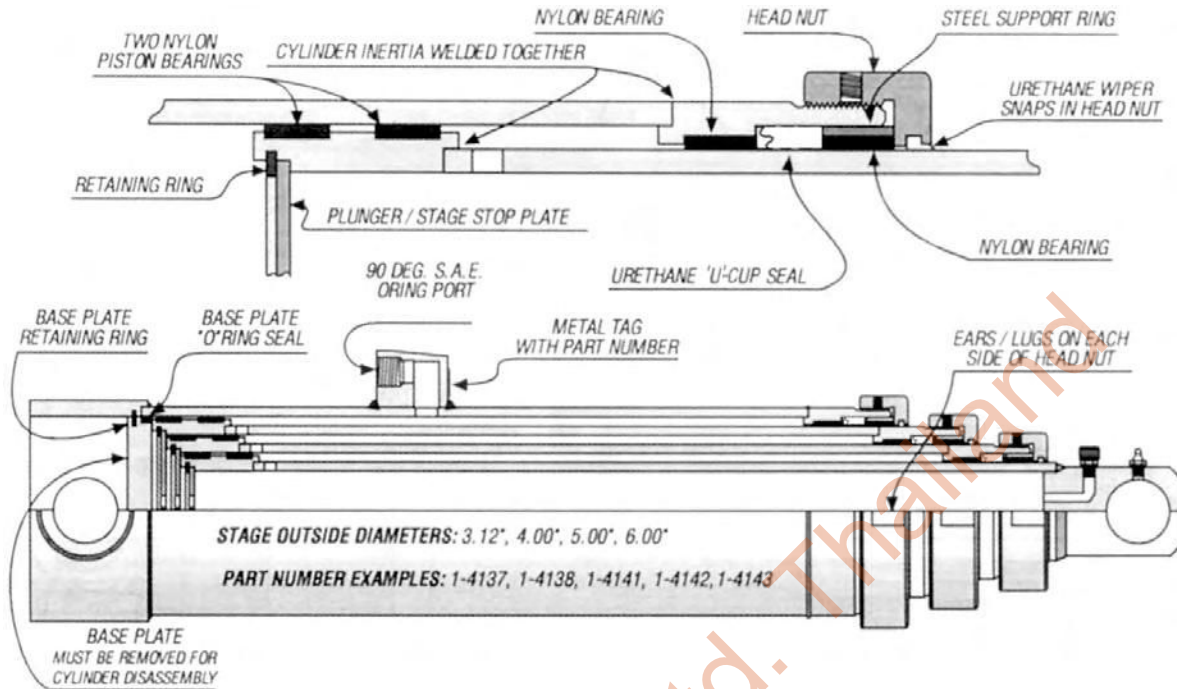

HYCO 900 - 2000 SERIES (MFG. PRIOR TO 6/74)

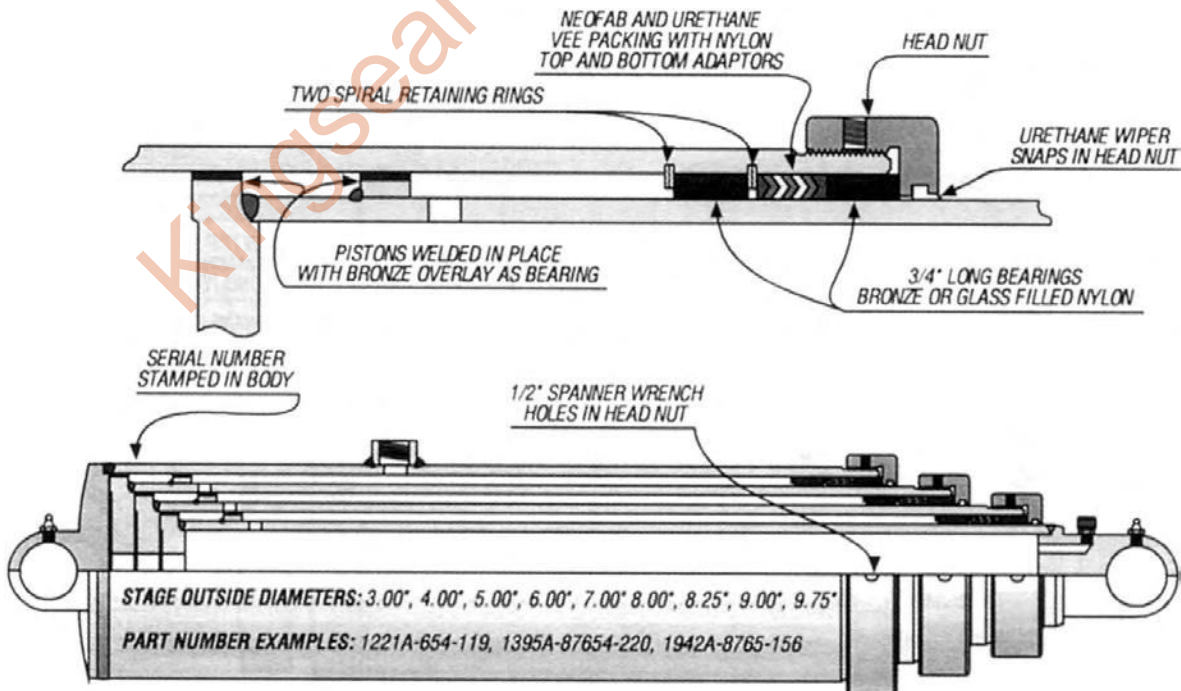

HYCO 10,000 SERIES

(MFG. PRIOR TO 7/74 TO 8/76)

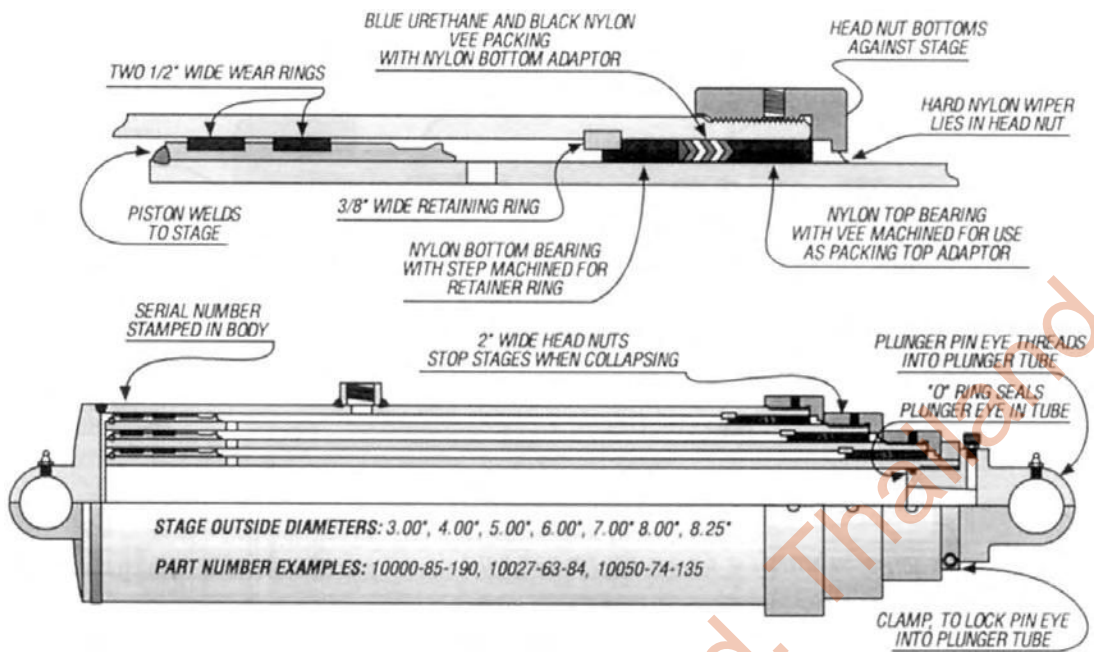

HYCO 30,000 SERIES

(OLD STYLE MFG. FROM 8/76 TO 7/81)
(NEW STYLE MFG. FROM 8/81 TO PRESENT)

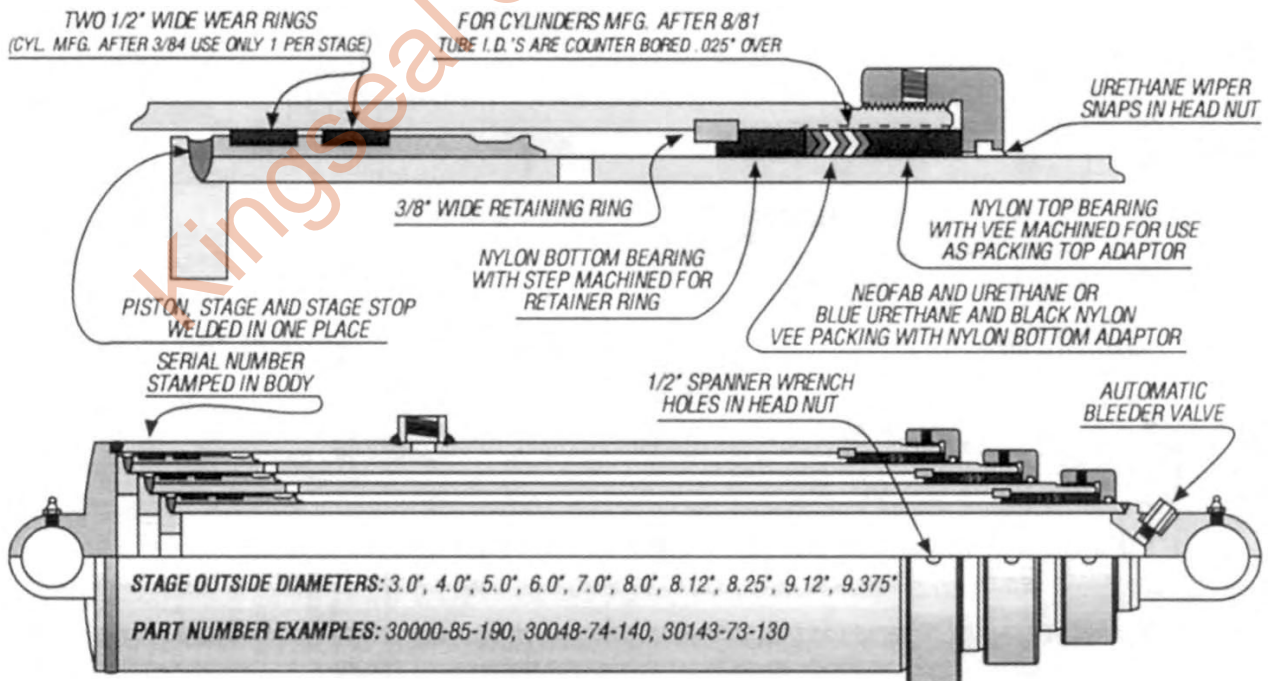

HYCO 30,000 SERIES

(NEW STYLE MFG. FROM 8/76 TO 7/81)

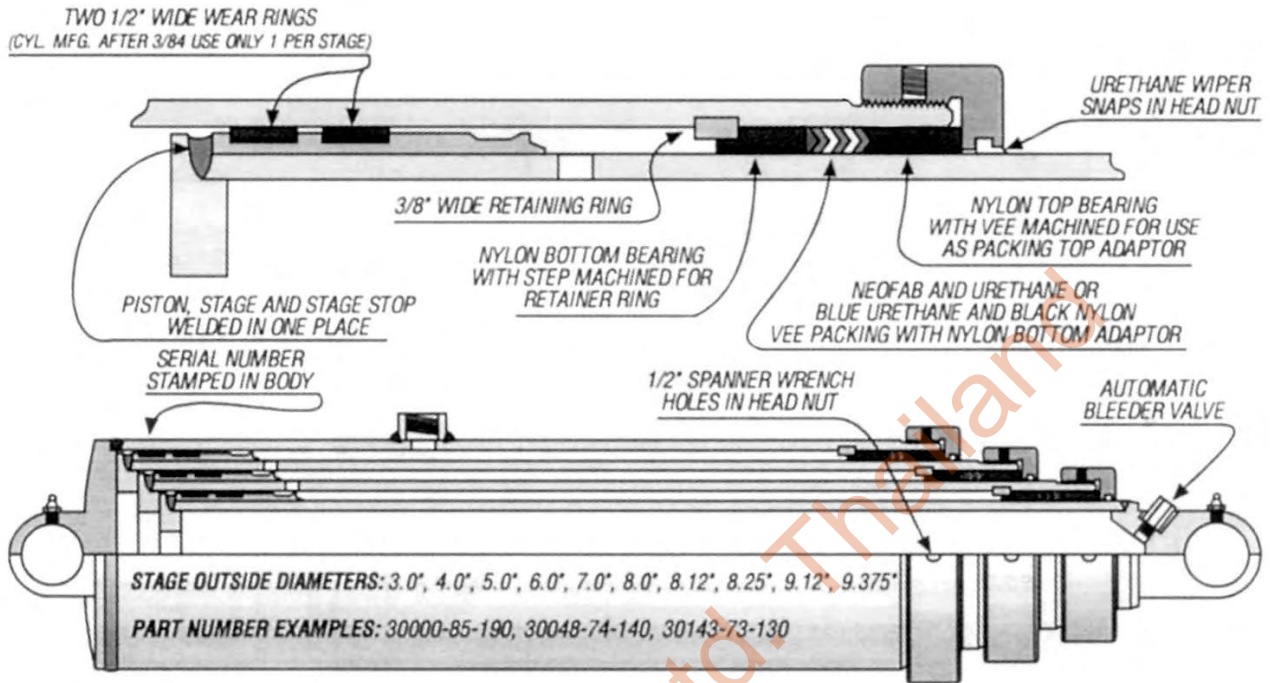

HYCO 70,000 SERIES

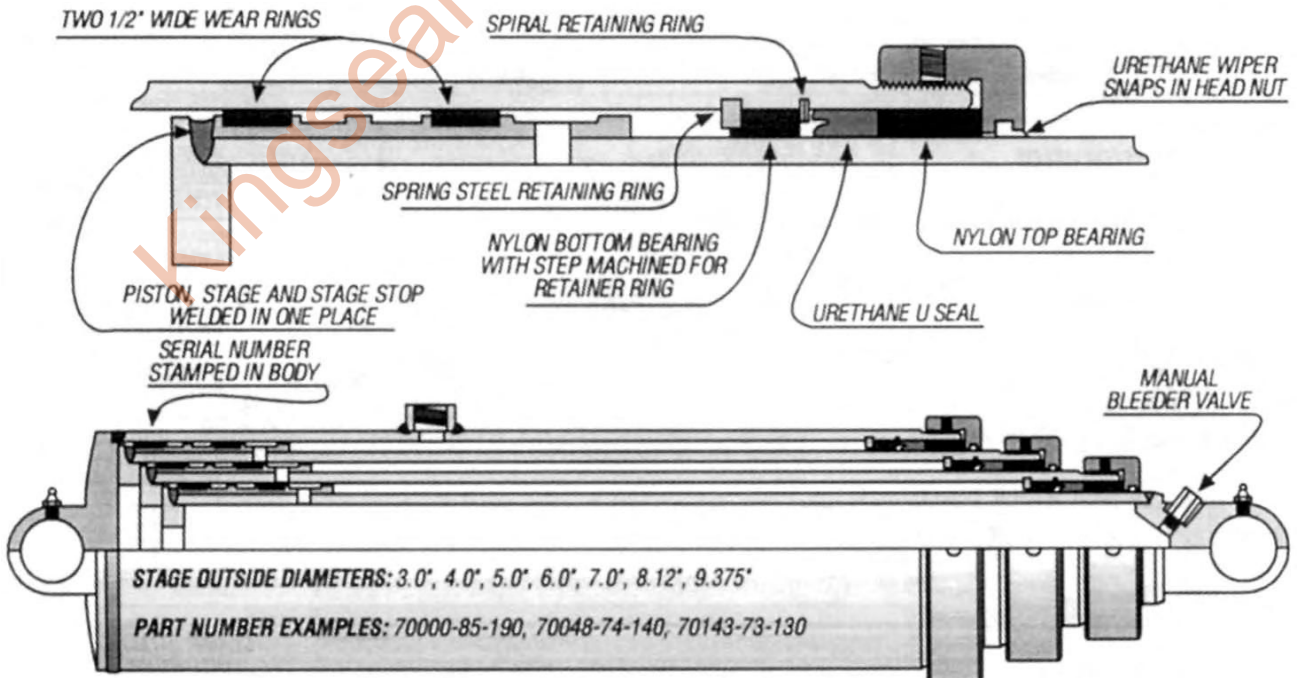

JOHNSON

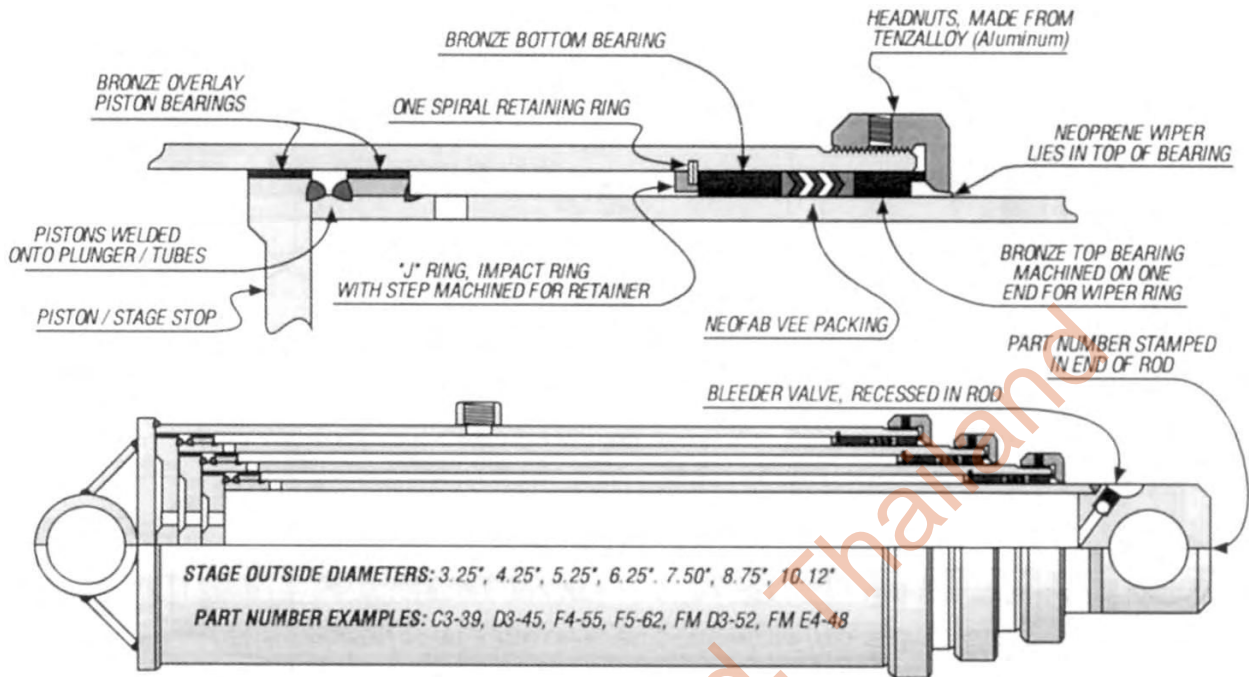

MARION MFG.

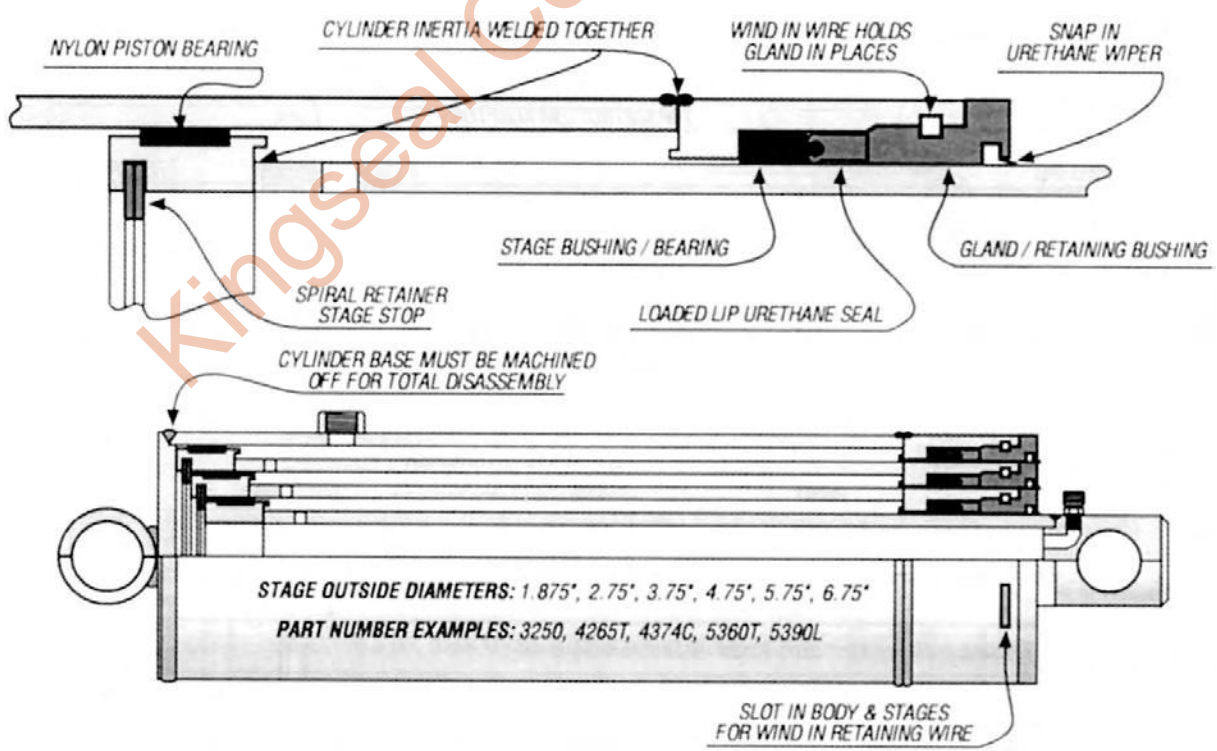

PEABODY GALION

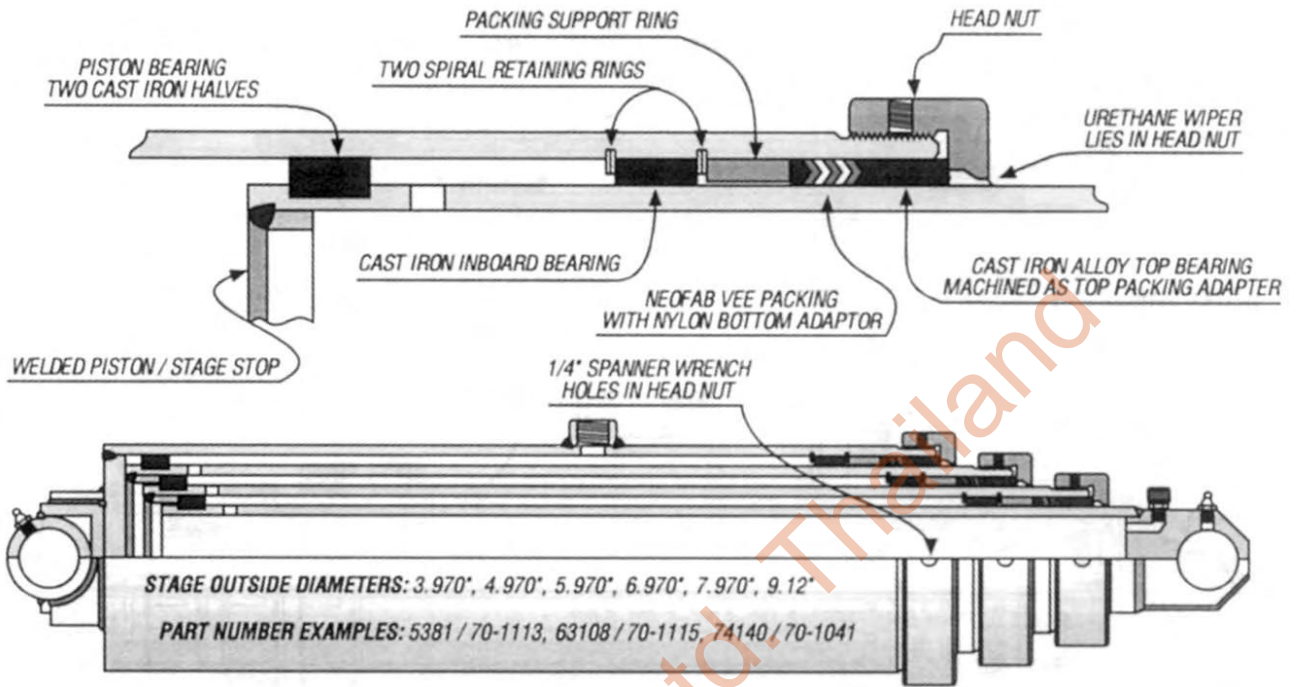

PERFECTION

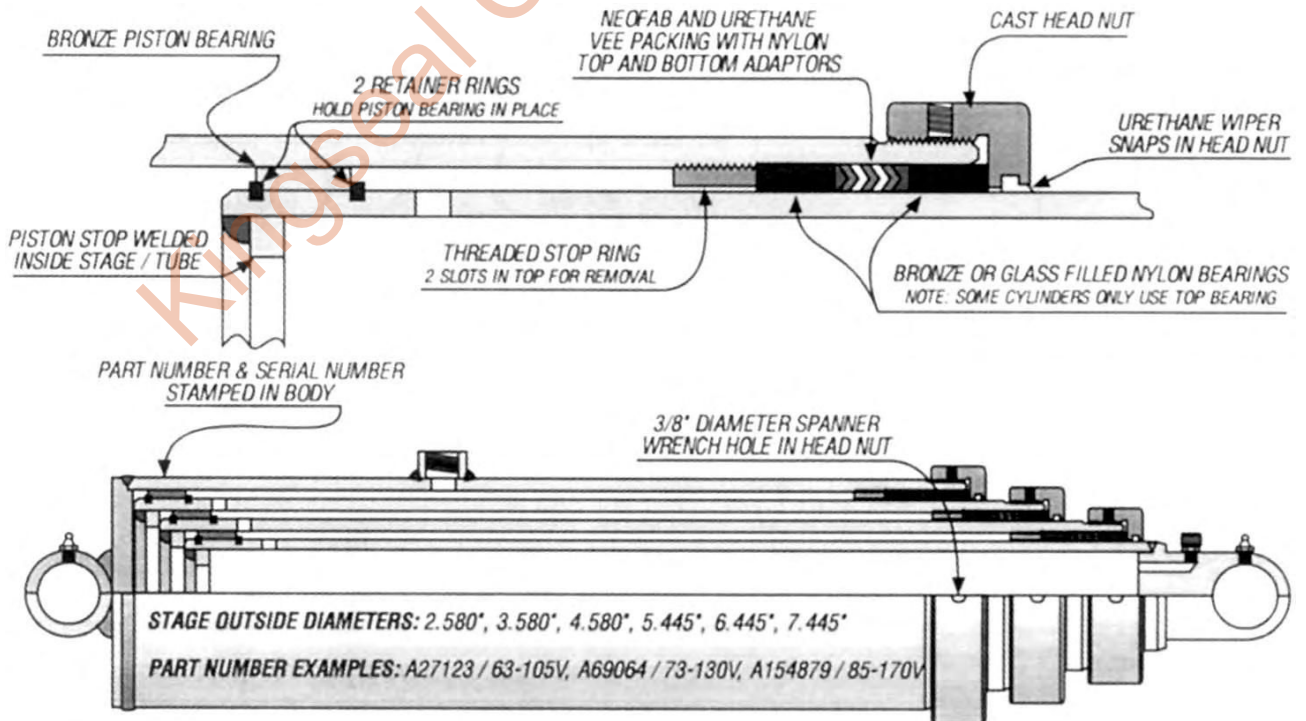

PERFECTION FARM HOISTS

APPENDIX

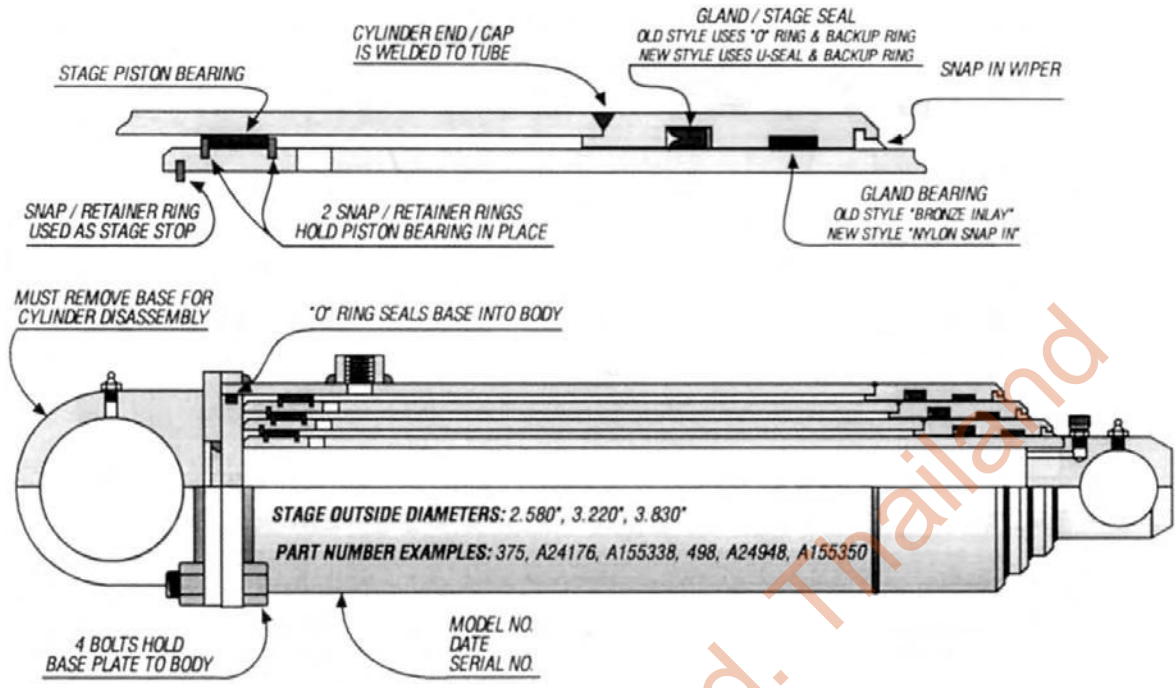

WARD CO.

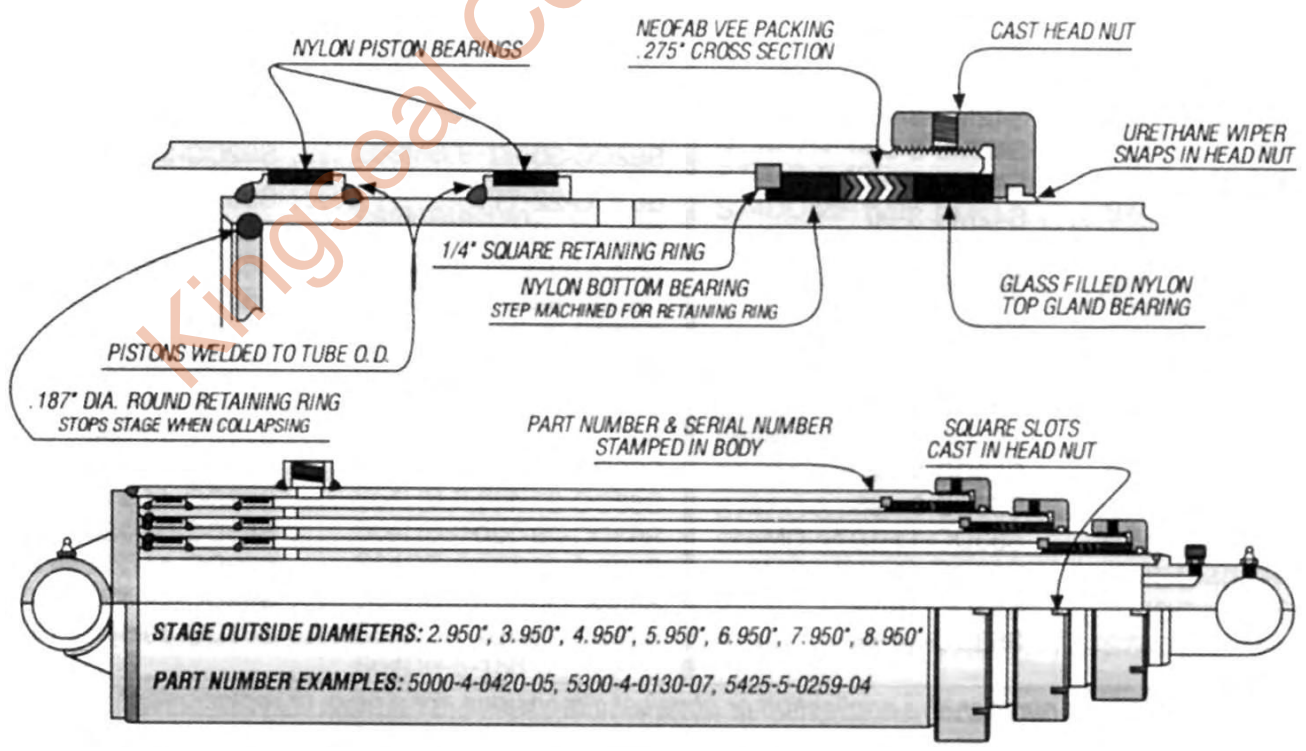

Kingseal Co., Ltd. Thailand



KINGSEAL CO., LTD. THAILAND

46/152-153 Moo 3 Sri Saman Road
Baan Mai Pakkret, Nonthaburi Thailand 11120

Tel: +662 9617534 to 6

Fax: +662 9617540

Email: intlsales@kingseal.co.th / kingsealmail@gmail.com

Website: <http://www.kingseal.co.th>
